

81 Environmental Tech
13550 N Highway 93
Las Vegas, NV 89165

Ticket Type: INBOUND INVOICE

Ticket Number: 22714
Date: 02/04/2011
Time In: 12:26 am
Time Out: 12:45 am

Customer: 001011 - NGE, LLC c/o Northgate Environ Mgmt

Vehicle/Container: 192309
Contract: RZE ASBESTO SOIL 3825 11 0022
Comment: 3825-11-0022

Gross Weight: 80,860 LB Scale In
Tare Weight: 40,120 LB Scale Out
Net Weight: 40740 LB
Net Tons: 20.37

BOL: RZB0615

Origin	Yards	Material	Billing	Quantity
Not Applicable	0.00 YD	ASBESTOS FRIABLE	20.37	TN

Driver: _____

Weighmaster: _____

SMITHJ

Indemnification. Customer agrees, by signature above, to indemnify, hold harmless, and defend Republic Services, Inc., its subsidiaries, affiliates, employees, officers and directors from and against any and all liabilities, claims, penalties, forfeitures, suits and the costs and expenses incident thereto, including costs of defense, settlement, and reasonable attorney's fees, which may be incurred, as a result of death or injuries to any person, or damage to any property, contamination of or adverse effects on the environment, caused in whole or in part by the Customer, its employees, or subcontractors in disposing waste at this Facility. In the event Customer delivers Unacceptable Waste (as determined by Republic) Customer agrees to assume all expenses and obligations with the removal and/or resolution of any effects caused by the delivery of such Unacceptable Waste.

Indemnización. Cliente acuerda indemnizar, mantener inmune, y defender Republic Services, Inc., sus subsidiarios, compañías, divisiones, empleados, oficiales y directores contra de cualquiera y de todas responsabilidades, demandas, penas, pérdidas, juicios, pleitos y los costos incidente además, incluyendo costos de defensa, de acuerdo judicial, y de honorarios razonables del abogado, que pueden ser incurridos en, o como resultado de, la muerte o herida personal a cualquier persona, o daños a cualquier característica, propiedad, contaminación de la tierra o efectos ilícitos en esta Facilidad, causado entero o en parte por el cliente, sus empleados, o sus subcontratistas en botar basura en esta Facilidad. En el caso que el Cliente entrega, bota, basura (según lo determinado por Republic) en este Establecimiento basura inaceptable en los reglamentos de este Establecimiento, el Cliente se compromete asumir todos los costos y obligaciones con el retiro y/o la resolución de cualquier dano(s) causado por la entrega de tal basura inaceptable.

NON-HAZARDOUS WASTE MANIFEST

1. Generator ID Number
NV100829030

2. Page 1 of 1
 3. Emergency Response Phone
(702) 353-4355

4. Waste Tracking Number
Manifest # RZE 3695

5. Generator's Name and Mailing Address
**Tronox
 P.O. Box 55
 Henderson, Nevada 89009 (702) 592-7727**

Generator's Site Address (if different than mailing address)
**Tronox LLC
 560 West Lake Mead Parkway
 Henderson, Nevada 89015**

Generator's Phone:
 6. Transporter 1 Company Name
Las Vegas Paving Corporation NDOT #0191949

U.S. EPA ID Number
NVD980768174

7. Transporter 2 Company Name

U.S. EPA ID Number

8. Designated Facility Name and Site Address
**Republic Services of Nevada
 Apex, Regional Landfill (702) 423-2128**

Profile Number **3825 11 0022**

U.S. EPA ID Number

Facility's Phone:

9. Waste Shipping Name and Description

10. Containers

11. Total Quantity

12. Unit Wt./Vol.

No.

Type

1. **Regulated Asbestos Containing Material
 Mixed with soil and construction debris**

Trk 14yards

20.37 74

2.

3.

4.

13. Special Handling Instructions and Additional Information

**Asbestos will be wetted down and loads shall be wrapped in 6-mill visqueen. Avoid opening wrapped loads. Breathing Asbestos is hazardous to your health.
 Call (702) 353-4355, David Breault and return to Generator if undeliverable.
 CCHD Permit #ATP11-010802 Expires 4/7/2011 DAQEM Project #100633**

14. GENERATOR'S/OFFEROR'S CERTIFICATION: I hereby declare that the contents of this consignment are fully and accurately described above by the proper shipping name, and are classified, packaged, marked and labeled/placarded, and are in all respects in proper condition for transport according to applicable international and national governmental regulations.

Generator's/Offeror's Printed/Typed Name
Susan Crowley

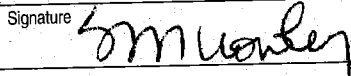
Signature

Month Day Year

15. International Shipments Import to U.S. Export from U.S.

Port of entry/exit:
 Date leaving U.S.:

Transporter Signature (for exports only):

16. Transporter Acknowledgment of Receipt of Materials

Transporter 1 Printed/Typed Name

WALL FRANK

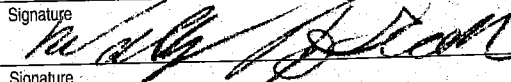
Signature

Month Day Year

Transporter 2 Printed/Typed Name

Signature

Month Day Year

17. Discrepancy

17a. Discrepancy Indication Space

Quantity

Type

Residue

Partial Rejection

Full Rejection

Manifest Reference Number:

U.S. EPA ID Number

17b. Alternate Facility (or Generator)

Facility's Phone:

17c. Signature of Alternate Facility (or Generator)

Month Day Year

LVPC Job Number 966525

18. Designated Facility Owner or Operator: Certification of receipt of materials covered by the manifest except as noted in Item 17a

Printed/Typed Name

JASON SMITH

Signature

Month Day Year

2 3 11

DESIGNATED FACILITY'S COPY

81 Environmental Tech
13550 N Highway 93
Las Vegas, NV 89165

Ticket Type: INBOUND INVOICE

Ticket Number: 22715
Date: 02/04/2011
Time In: 12:32 am
Time Out: 12:52 am

Customer: 001011 - NGE, LLC c/o Northgate Environ Mgmt

Vehicle/Container: 192308
Contract: RZE ASBESTO SOIL 3825 11 0022
Comment: 3825-11-0022

Gross Weight: 80,040 LB Scale In
Tare Weight: 39,720 LB Scale Out
Net Weight: 40320 LB
Net Tons: 20.16

BOL: RZB0616

Origin	Yards	Material	Billing	Quantity
Not Applicable	0.00 YD	ASBESTOS FRIABLE	20.16	TN

Driver:

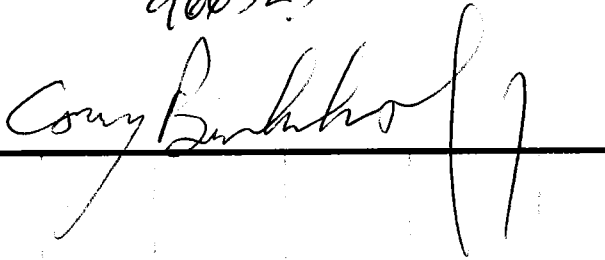
966525

Weighmaster:

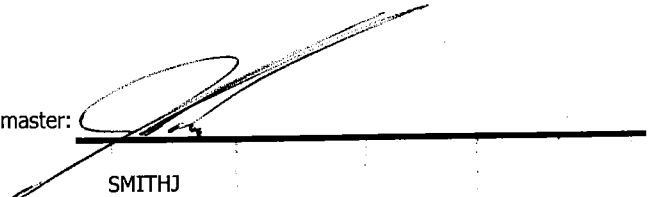
SMITHJ

Indemnification. Customer agrees, by signature above, to indemnify, hold harmless, and defend Republic Services, Inc., its subsidiaries, affiliates, employees, officers and directors from and against any and all liabilities, claims, penalties, forfeitures, suits and the costs and expenses incident thereto, including costs of defense, settlement, and reasonable attorney's fees, which may be incurred, as a result of death or injuries to any person, or damage to any property, contamination of or adverse effects on the environment, caused in whole or in part by the Customer, its employees, or subcontractors in disposing waste at this Facility. In the event Customer delivers Unacceptable Waste (as determined by Republic) Customer agrees to assume all expenses and obligations with the removal and/or resolution of any effects caused by the delivery of such Unacceptable Waste.

Indemnización. Cliente acuerda indemnizar, mantener inmune, y defender Republic Services, Inc., sus subsidiarios, compañías, divisiones, empleados, oficiales y directores contra de cualquiera y de todas responsabilidades, demandas, penas, pérdidas, juicios, pleitos y los costos incidente además, incluyendo costos de defensa, de acuerdo judicial, y de honorarios razonables del abogado, que pueden ser incurridos en, o como resultado de, la muerte o herida personal a cualquier persona, o daños a cualquier característica, propiedad, contaminación de la tierra o efectos ilícitos en esta Facilidad, causado entero o en parte por el cliente, sus empleados, o sus subcontratistas en botar basura en esta Facilidad. En el caso que el Cliente entrega, bota, basura (según lo determinado por Republic) en este Establecimiento basura inaceptable en los reglamentos de este Establecimiento, el Cliente se compromete asumir todos los costos y obligaciones con el retiro y/o la resolución de cualquier dano(s) causado por la entrega de tal basura inaceptable.

NON-HAZARDOUS WASTE MANIFEST

1. Generator ID Number
NVD008290330

2. Page 1 of 1

3. Emergency Response Phone
(702) 353-4355

4. Waste Tracking Number
Manifest # RZE 3016

5. Generator's Name and Mailing Address
Tronox
P.O. Box 55
Henderson, Nevada 89009 (702) 592-7727

Generator's Site Address (if different than mailing address)
Tronox LLC
560 West Lake Mead Parkway
Henderson, Nevada 89015

Generator's Phone:
6. Transporter 1 Company Name
Las Vegas Paving Corporation NDOT #0191949

U.S. EPA ID Number
NVD986758174

7. Transporter 2 Company Name

U.S. EPA ID Number

8. Designated Facility Name and Site Address
Republic Services of Nevada
Apex, Regional Landfill (702) 423-2128

Profile Number **3825 11 0022**

U.S. EPA ID Number

Facility's Phone:

9. Waste Shipping Name and Description

10. Containers

11. Total Quantity

12. Unit Wt./Vol.

No.

Type

1. **Regulated Asbestos Containing Material**
Mixed with soil and construction debris

Trk 14yards

20.16 TU

2.

3.

4.

13. Special Handling Instructions and Additional Information

Asbestos will be wetted down and loads shall be wrapped in 6-mil visqueen. Avoid opening wrapped loads. Breathing Asbestos is hazardous to your health.
Call (702) 353-4355, David Breault and return to Generator if undeliverable.
CCHD Permit #ATP11-010802 Expires 4/7/2011 **DAQEM Project #100633**

14. GENERATOR'S/OFFEROR'S CERTIFICATION: I hereby declare that the contents of this consignment are fully and accurately described above by the proper shipping name, and are classified, packaged, marked and labeled/placarded, and are in all respects in proper condition for transport according to applicable international and national governmental regulations.

Generator's/Offoror's Printed/Typed Name
Susan Crowley

Signature
Susan Crowley

Month Day Year

15. International Shipments Import to U.S.

Export from U.S.

Port of entry/exit:

Date leaving U.S.:

Transporter Signature (for exports only):

16. Transporter Acknowledgment of Receipt of Materials

Transporter 1 Printed/Typed Name

Carey Binkerkhoff

Signature

Carey Binkerkhoff

Month Day Year

2 3 11

Transporter 2 Printed/Typed Name

Signature

Month Day Year

17. Discrepancy

17a. Discrepancy Indication Space

Quantity

Type

Residue

Partial Rejection

Full Rejection

Manifest Reference Number:

U.S. EPA ID Number

17b. Alternate Facility (or Generator)

Facility's Phone:

17c. Signature of Alternate Facility (or Generator)

Month Day Year

LVPC Job Number 966525

18. Designated Facility Owner or Operator. Certification of receipt of materials covered by the manifest except as noted in Item 17a

Printed/Typed Name

J. S. Smith

Signature

J. S. Smith

Month Day Year

2 4 10

81 Environmental Tech
13550 N Highway 93
Las Vegas, NV 89165

Ticket Type: INBOUND INVOICE

Ticket Number: 22716
Date: 02/04/2011
Time In: 12:39 am
Time Out: 12:56 am

Customer: 001011 - NGE, LLC c/o Northgate Environ Mgmt

Vehicle/Container: 192391
Contract: RZE ASBESTO SOIL 3825 11 0022
Comment: 3825-11-0022

Gross Weight: 81,460 LB Scale In
Tare Weight: 38,760 LB Scale Out
Net Weight: 42700 LB
Net Tons: 21.35

BOL: RZB0617

Origin	Yards	Material	Billing	Quantity
Not Applicable	0.00 YD	ASBESTOS FRIABLE	21.35	TN

Driver: _____

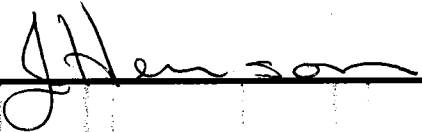

Weighmaster: _____

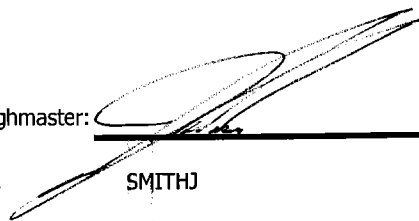

SMITHJ

Indemnification. Customer agrees, by signature above, to indemnify, hold harmless, and defend Republic Services, Inc., its subsidiaries, affiliates, employees, officers and directors from and against any and all liabilities, claims, penalties, forfeitures, suits and the costs and expenses incident thereto, including costs of defense, settlement, and reasonable attorney's fees, which may be incurred, as a result of death or injuries to any person, or damage to any property, contamination of or adverse effects on the environment, caused in whole or in part by the Customer, its employees, or subcontractors in disposing waste at this Facility. In the event Customer delivers Unacceptable Waste (as determined by Republic) Customer agrees to assume all expenses and obligations with the removal and/or resolution of any effects caused by the delivery of such Unacceptable Waste.

Indemnización. Cliente acuerda indemnizar, mantener inmune, y defender Republic Services, Inc., sus subsidiarios, compañías, divisiones, empleados, oficiales y directores contra de cualquiera y de todas responsabilidades, demandas, penas, pérdidas, juicios, pleitos y los costos incidente además, incluyendo costos de defensa, de acuerdo judicial, y de honorarios razonables del abogado, que pueden ser incurridos en, o como resultado de, la muerte o herida personal a cualquier persona, o daños a cualquier característica, propiedad, contaminación de la tierra o efectos ilícitos en esta Facilidad, causado entero o en parte por el cliente, sus empleados, o sus subcontratistas en botar basura en esta Facilidad. En el caso que el Cliente entrega, bota, basura (según lo determinado por Republic) en este Establecimiento basura inaceptable en los reglamentos de este Establecimiento, el Cliente se compromete asumir todos los costos y obligaciones con el retiro y/o la resolución de cualquier dano(s) causado por la entrega de tal basura inaceptable.

NON-HAZARDOUS WASTE MANIFEST

1. Generator ID Number
NVT000296130

2. Page 1 of

3. Emergency Response Phone
(702) 353-4355

4. Waste Tracking Number
Manifest # RZE 617

5. Generator's Name and Mailing Address

Tronox
P.O. Box 55
Henderson, Nevada 89009 (702) 592-7127

Generator's Site Address (if different than mailing address)

Tronox LLC
560 West Lake Mead Parkway
Henderson, Nevada 89015

Generator's Phone:

6. Transporter 1 Company Name
Las Vegas Paving Corporation NDOT #0191949

U.S. EPA ID Number
NVD0980768174

7. Transporter 2 Company Name

U.S. EPA ID Number

8. Designated Facility Name and Site Address

Republic Services of Nevada
Apex, Regional Landfill (702) 423-2128

Profile Number **3825 11 0022**

U.S. EPA ID Number

Facility's Phone:

9. Waste Shipping Name and Description

10. Containers

No. Type

11. Total Quantity

12. Unit Wt./Vol.

1. **Regulated Asbestos Containing Material**
Mixed with soil and construction debris

Trk 14yards

21.35 TU

2.

3.

4.

13. Special Handling Instructions and Additional Information

Asbestos will be wetted down and loads shall be wrapped in 6-mill visqueen. Avoid opening wrapped loads. Breathing Asbestos is hazardous to your health.
Call (702) 353-4355, David Breault and return to Generator if undeliverable.
CCHD Permit #ATP11-010802 Expires 4/7/2011 DAQEM Project #100633

14. GENERATOR'S/OFFEROR'S CERTIFICATION: I hereby declare that the contents of this consignment are fully and accurately described above by the proper shipping name, and are classified, packaged, marked and labeled/placarded, and are in all respects in proper condition for transport according to applicable international and national governmental regulations.

Generator's/Offeror's Printed/Typed Name
Susan Crowley

Signature

Susan Crowley

Month Day Year

15. International Shipments Import to U.S. Export from U.S.

Port of entry/exit:

Date leaving U.S.:

Transporter Signature (for exports only):

16. Transporter Acknowledgment of Receipt of Materials

Transporter 1 Printed/Typed Name

J. Henson

Signature

J. Henson

Month Day Year

2 3 11

Transporter 2 Printed/Typed Name

Signature

17. Discrepancy

17a. Discrepancy Indication Space Quantity Type Residue Partial Rejection Full Rejection

Manifest Reference Number:

U.S. EPA ID Number:

17b. Alternate Facility (or Generator)

Facility's Phone:

17c. Signature of Alternate Facility (or Generator)

Month Day Year

LVPC Job Number 966525

18. Designated Facility Owner or Operator: Certification of receipt of materials covered by the manifest except as noted in Item 17a

Printed/Typed Name

J. San Jn. 11

Signature

J. San Jn. 11

Month Day Year

2 3 11

DESIGNATED FACILITY'S COPY

81 Environmental Tech
13550 N Highway 93
Las Vegas, NV 89165

Ticket Type: INBOUND INVOICE

Ticket Number: 22717
Date: 02/04/2011
Time In: 12:42 am
Time Out: 12:58 am

Customer: 001011 - NGE, LLC c/o Northgate Environ Mgmt

Vehicle/Container: 192369
Contract: RZE ASBESTO SOIL 3825 11 0022
Comment: 3825-11-0022

Gross Weight: 84,920 LB Scale In
Tare Weight: 41,260 LB Scale Out
Net Weight: 43660 LB
Net Tons: 21.83

BOL: RZB0618

Origin	Yards	Material	Billing	Quantity
Not Applicable	0.00 YD	ASBESTOS FRIABLE	21.83	TN

Driver: Jay Paolan

Weighmaster: SMITHJ

SMITHJ

Indemnification. Customer agrees, by signature above, to indemnify, hold harmless, and defend Republic Services, Inc., its subsidiaries, affiliates, employees, officers and directors from and against any and all liabilities, claims, penalties, forfeitures, suits and the costs and expenses incident thereto, including costs of defense, settlement, and reasonable attorney's fees, which may be incurred, as a result of death or injuries to any person, or damage to any property, contamination of or adverse effects on the environment, caused in whole or in part by the Customer, its employees, or subcontractors in disposing waste at this Facility. In the event Customer delivers Unacceptable Waste (as determined by Republic) Customer agrees to assume all expenses and obligations with the removal and/or resolution of any effects caused by the delivery of such Unacceptable Waste.

Indemnización. Cliente acuerda indemnizar, mantener inmune, y defender Republic Services, Inc., sus subsidiarios, compañías, divisiones, empleados, oficiales y directores contra de cualquiera y de todas responsabilidades, demandas, penas, pérdidas, juicios, pleitos y los costos incidente además, incluyendo costos de defensa, de acuerdo judicial, y de honorarios razonables del abogado, que pueden ser incurridos en, o como resultado de, la muerte o herida personal a cualquier persona, o daños a cualquier característica, propiedad, contaminación de la tierra o efectos ilícitos en esta Facilidad, causado entero o en parte por el cliente, sus empleados, o sus subcontratistas en botar basura en esta Facilidad. En el caso que el Cliente entrega, bota, basura (según lo determinado por Republic) en este Establecimiento basura inaceptable en los reglamentos de este Establecimiento, el Cliente se compromete asumir todos los costos y obligaciones con el retiro y/o la resolución de cualquier dano(s) causado por la entrega de tal basura inaceptable.

NON-HAZARDOUS WASTE MANIFEST

1. Permit # **ND00000330**

2. Page 1 of 3

3. Generator's Phone (702) 592-7727

4. Waste Tracking # **ND00000330**

37518

5. Generator's Name and Mailing Address
**P.O. Box 55
 Henderson, Nevada 89009 (702) 592-7727**

Generator's City and State (if different than mailing address)
**Henderson, NV
 560 West Lake Mead Parkway
 Henderson, Nevada 89015**

Generator's Phone:

6. Transporter 1 **Chambers Paving Corporation** **NDOT #0191949**

U.S. EPA ID # **ND0000168174**

7. Transporter 2 Company Name

U.S. EPA ID Number

8. Designated Facility Name and Site Address
**Republic Services of Nevada
 Apex, Regional Landfill (702) 423-2128**

Profile Number 3825 11 0022

U.S. EPA ID Number

Facility's Phone:

9. Waste Shipping Name and Description	10. Containers		11. Total Quantity	12. Unit Wt./Vol.
	No.	Type		
1. Regulated Asbestos Containing Material Mixed with soil and construction debris		Trk	14 yards	
2.			21.83	TN
3.				
4.				

13. Special Handling Instructions and Additional Information
**Asbestos will be wetted down and loads shall be wrapped in 6-mil visqueen. Avoid opening wrapped loads. Breathing Asbestos is hazardous to your health.
 Call (702) 353-4355, David Bresault and return to Generator if undeliverable.
 CCHD Permit #ATP11-010802 Expires 4/7/2011 DAQEM Project #100633**

14. GENERATOR'S/OFFEROR'S CERTIFICATION: I hereby declare that the contents of this consignment are fully and accurately described above by the proper shipping name, and are classified, packaged, marked and labeled/placarded, and are in all respects in proper condition for transport according to applicable international and national governmental regulations.

Generator's/Offoror's Printed/Typed Name **Susan Crowley** Signature *Susan Crowley* Month Day Year

15. International Shipments Import to U.S. Export from U.S. Port of entry/exit: Date leaving U.S.:

16. Transporter Acknowledgment of Receipt of Materials

Transporter 1 Printed/Typed Name **Tony Padovic** Signature *Tony Padovic* Month Day Year

Transporter 2 Printed/Typed Name Signature Month Day Year

17. Discrepancy

17a. Discrepancy Indication Space Quantity Type Residue Partial Rejection Full Rejection

Manifest Reference Number: U.S. EPA ID Number

17b. Alternate Facility (or Generator) U.S. EPA ID Number

Facility's Phone:

17c. Signature of Alternate Facility (or Generator) Month Day Year

LVPC Job Number 966525

18. Designated Facility Owner or Operator: Certification of receipt of materials covered by the manifest except as noted in Item 17a

Printed/Typed Name **Jesse Smith** Signature *Jesse Smith* Month Day Year **2 3 11**

GENERATOR
INT'L
TRANSPORTER
DESIGNATED FACILITY

81 Environmental Tech
13550 N Highway 93
Las Vegas, NV 89165

Ticket Type: INBOUND INVOICE

Ticket Number: 22718
Date: 02/04/2011
Time In: 12:52 am
Time Out: 1:12 am

Customer: 001011 - NGE, LLC c/o Northgate Environ Mgmt

Vehicle/Container: 192392
Contract: RZE ASBESTO SOIL 3825 11 0022
Comment: 3825-11-0022

Gross Weight: 87,360 LB Scale In
Tare Weight: 41,900 LB Scale Out
Net Weight: 45460 LB
Net Tons: 22.73

BOL: RZE0619

Origin	Yards	Material	Billing Quantity
Not Applicable	0.00 YD	ASBESTOS FRIABLE	22.73 TN

Driver: _____

Weighmaster: _____

SMITHJ

Indemnification. Customer agrees, by signature above, to indemnify, hold harmless, and defend Republic Services, Inc., its subsidiaries, affiliates, employees, officers and directors from and against any and all liabilities, claims, penalties, forfeitures, suits and the costs and expenses incident thereto, including costs of defense, settlement, and reasonable attorney's fees, which may be incurred, as a result of death or injuries to any person, or damage to any property, contamination of or adverse effects on the environment, caused in whole or in part by the Customer, its employees, or subcontractors in disposing waste at this Facility. In the event Customer delivers Unacceptable Waste (as determined by Republic) Customer agrees to assume all expenses and obligations with the removal and/or resolution of any effects caused by the delivery of such Unacceptable Waste.

Indemnización. Cliente acuerda indemnizar, mantener inmune, y defender Republic Services, Inc., sus subsidiarios, compañías, divisiones, empleados, oficiales y directores contra de cualquiera y de todas responsabilidades, demandas, penas, pérdidas, juicios, pleitos y los costos incidente además, incluyendo costos de defensa, de acuerdo judicial, y de honorarios razonables del abogado, que pueden ser incurridos en, o como resultado de, la muerte o herida personal a cualquier persona, o daños a cualquier característica, propiedad, contaminación de la tierra o efectos ilícitos en esta Facilidad, causado entero o en parte por el cliente, sus empleados, o sus subcontratistas en botar basura en esta Facilidad. En el caso que el Cliente entrega, bota, basura (según lo determinado por Republic) en este Establecimiento basura inaceptable en los reglamentos de este Establecimiento, el Cliente se compromete asumir todos los costos y obligaciones con el retiro y/o la resolución de cualquier dano(s) causado por la entrega de tal basura inaceptable.

**NON-HAZARDOUS
WASTE MANIFEST**

1. Generator ID Number
NVD008290330

2. Page 1 of 1

3. Emergency Response Phone
(702) 353-4355

4. Waste Tracking Number
Manifest # RLE

37819

5. Generator's Name and Mailing Address

**Tronox
P.O. Box 55
Henderson, Nevada 89009 (702) 592-7727**

Generator's Site Address, (if different than mailing address)

**Tronox LLC
560 West Lake Mead Parkway
Henderson, Nevada 89015**

Generator's Phone:

6. Transporter 1 Company Name

Las Vegas Paving Corporation NDOT #0191949

U.S. EPA ID Number

NVD986768174

7. Transporter 2 Company Name

U.S. EPA ID Number

8. Designated Facility Name and Site Address

**Republic Services of Nevada
Apex, Regional Landfill (702) 423-2128**

U.S. EPA ID Number

Profile Number 3825 11 0022

Facility's Phone:

9. Waste Shipping Name and Description

10. Containers

No. Type

11. Total Quantity

12. Unit Wt./Vol.

1. **Regulated Asbestos Containing Material
Mixed with soil and construction debris**

Trk 14 yards

22.73 T

2.

3.

4.

13. Special Handling Instructions and Additional Information

**Asbestos will be wetted down and loads shall be wrapped in 6-mil visqueen. Avoid opening wrapped loads. Breathing Asbestos is hazardous to your health.
Call (702) 353-4355, David Breault and return to Generator if undeliverable.
CCHD Permit #ATP11-010802 Expires 4/7/2011 DAQEM Project #100633**

14. GENERATOR'S/OFFEROR'S CERTIFICATION: I hereby declare that the contents of this consignment are fully and accurately described above by the proper shipping name, and are classified, packaged, marked and labeled/placarded, and are in all respects in proper condition for transport according to applicable international and national governmental regulations.

Generator's/Offorer's Printed/Typed Name

Susan Crowley

Signature

Susan Crowley

Month Day Year

15. International Shipments

Import to U.S.

Export from U.S.

Port of entry/exit:

Date leaving U.S.:

Transporter Signature (for exports only):

TRANSPORTER

16. Transporter Acknowledgment of Receipt of Materials

Transporter 1 Printed/Typed Name

Terrell

Signature

Terrell

Month Day Year

Transporter 2 Printed/Typed Name

Signature

Month Day Year

17. Discrepancy

17a. Discrepancy Indication Space

Quantity

Type

Residue

Partial Rejection

Full Rejection

Manifest Reference Number:

U.S. EPA ID Number

DESIGNATED FACILITY

17b. Alternate Facility (or Generator)

Facility's Phone:

17c. Signature of Alternate Facility (or Generator)

Month Day Year

LVPC Job Number 966525

18. Designated Facility Owner or Operator: Certification of receipt of materials covered by the manifest except as noted in Item 17a

Printed/Typed Name

Jessie Garcia

Signature

Jessie Garcia

Month Day Year

2 5 11

DESIGNATED FACILITY'S COPY

81 Environmental Tech
13550 N Highway 93
Las Vegas, NV 89165

Ticket Type: INBOUND INVOICE

Ticket Number: 22719
Date: 02/04/2011
Time In: 12:56 am
Time Out: 1:13 am

Customer: 001011 - NGE, LLC c/o Northgate Environ Mgmt

Vehicle/Container: 192367
Contract: RZE ASBESTO SOIL 3825 11 0022
Comment: 3825-11-0022

Gross Weight: 81,440 LB Scale In
Tare Weight: 38,580 LB Scale Out
Net Weight: 42860 LB
Net Tons: 21.43

BOL: RZE0620

Origin	Yards	Material	Billing	Quantity
Not Applicable	0.00 YD	ASBESTOS FRIABLE	21.43	TN

Driver:

T. Richards

Weighmaster:

[Signature]
SMITHJ

Indemnification. Customer agrees, by signature above, to indemnify, hold harmless, and defend Republic Services, Inc., its subsidiaries, affiliates, employees, officers and directors from and against any and all liabilities, claims, penalties, forfeitures, suits and the costs and expenses incident thereto, including costs of defense, settlement, and reasonable attorney's fees, which may be incurred, as a result of death or injuries to any person, or damage to any property, contamination of or adverse effects on the environment, caused in whole or in part by the Customer, its employees, or subcontractors in disposing waste at this Facility. In the event Customer delivers Unacceptable Waste (as determined by Republic) Customer agrees to assume all expenses and obligations with the removal and/or resolution of any effects caused by the delivery of such Unacceptable Waste.

Indemnización. Cliente acuerda indemnizar, mantener inmune, y defender Republic Services, Inc., sus subsidiarios, compañías, divisiones, empleados, oficiales y directores contra de cualquiera y de todas responsabilidades, demandas, penas, pérdidas, juicios, pleitos y los costos incidente además, incluyendo costos de defensa, de acuerdo judicial, y de honorarios razonables del abogado, que pueden ser incurridos en, o como resultado de, la muerte o herida personal a cualquier persona, o daños a cualquier característica, propiedad, contaminación de la tierra o efectos ilícitos en esta Facilidad, causado entero o en parte por el cliente, sus empleados, o sus subcontratistas en botar basura en esta Facilidad. En el caso que el Cliente entrega, bota, basura (según lo determinado por Republic) en este Establecimiento basura inaceptable en los reglamentos de este Establecimiento, el Cliente se compromete asumir todos los costos y obligaciones con el retiro y/o la resolución de cualquier dano(s) causado por la entrega de tal basura inaceptable.

NON-HAZARDOUS WASTE MANIFEST

1. Generator ID Number
NV19008298130

2. Page 1 of 1

3. Emergency Response Phone
(702) 353-4355

4. Waste Tracking Number
Manifest # RZE 829

5. Generator's Name and Mailing Address
Ironox
P.O. Box 55
Henderson, Nevada 89009 (702) 592-7727

Generator's Site Address (if different than mailing address)
Ironox LLC
560 West Lake Mead Parkway
Henderson, Nevada 89015

Generator's Phone:

6. Transporter 1 Company Name
Las Vegas Paving Corporation NDOT #0191949

U.S. EPA ID Number
NV19006768174

7. Transporter 2 Company Name

U.S. EPA ID Number

8. Designated Facility Name and Site Address

Republic Services of Nevada
Apex, Regional Landfill (702) 423-2128

Profile Number **3825 11 0022**

U.S. EPA ID Number

Facility's Phone:

9. Waste Shipping Name and Description	10. Containers		11. Total Quantity	12. Unit Wt./Vol.
	No.	Type		
1. Regulated Asbestos Containing Material Mixed with soil and construction debris		Trk	14yards	
2.			21.43	TU
3.				
4.				

13. Special Handling Instructions and Additional Information

Asbestos will be wetted down and loads shall be wrapped in 6-mil visqueen. Avoid opening wrapped loads. Breathing Asbestos is hazardous to your health.

Call (702) 353-4355, David Breault and return to Generator if undeliverable.

CCHD Permit #ATP11-010802 Expires 4/7/2011 DAQEM Project #100633

14. GENERATOR'S/OFFEROR'S CERTIFICATION: I hereby declare that the contents of this consignment are fully and accurately described above by the proper shipping name, and are classified, packaged, marked and labeled/placarded, and are in all respects in proper condition for transport according to applicable international and national governmental regulations.

Generator's/Offoror's Printed/Typed Name
Susan Crowley

Signature

S. Crowley

Month Day Year

INT'L

15. International Shipments Import to U.S. Export from U.S.

Port of entry/exit:

Date leaving U.S.:

TRANSPORTER

16. Transporter Acknowledgment of Receipt of Materials

Transporter 1 Printed/Typed Name

T. Richards

Signature

T. Richards

Month Day Year

02 04 11

Transporter 2 Printed/Typed Name

Signature

DESIGNATED FACILITY

17. Discrepancy

17a. Discrepancy Indication Space

Quantity

Type

Residue

Partial Rejection

Full Rejection

Manifest Reference Number:

U.S. EPA ID Number

17b. Alternate Facility (or Generator)

Facility's Phone:

17c. Signature of Alternate Facility (or Generator)

Month Day Year

LVPC Job Number 966525

18. Designated Facility Owner or Operator: Certification of receipt of materials covered by the manifest except as noted in Item 17a

Printed/Typed Name

Resol Smith

Signature

[Signature]

Month Day Year

2 3 11

DESIGNATED FACILITY'S COPY

81 Environmental Tech
13550 N Highway 93
Las Vegas, NV 89165

Ticket Type: INBOUND INVOICE

Ticket Number: 22720
Date: 02/04/2011
Time In: 12:59 am
Time Out: 1:19 am

Customer: 001011 - NGE, LLC c/o Northgate Environ Mgmt

Vehicle/Container: 192358
Contract: RZE ASBESTO SOIL 3825 11 0022
Comment: 3825-11-0022

Gross Weight: 80,060 LB Scale In
Tare Weight: 38,960 LB Scale Out
Net Weight: 41100 LB
Net Tons: 20.55

BOL: RZE0621

Origin	Yards	Material	Billing	Quantity
Not Applicable	0.00 YD	ASBESTOS FRIABLE	20.55	TN

Driver: 

Weighmaster: 

SMITHJ

Indemnification. Customer agrees, by signature above, to indemnify, hold harmless, and defend Republic Services, Inc., its subsidiaries, affiliates, employees, officers and directors from and against any and all liabilities, claims, penalties, forfeitures, suits and the costs and expenses incident thereto, including costs of defense, settlement, and reasonable attorney's fees, which may be incurred, as a result of death or injuries to any person, or damage to any property, contamination of or adverse effects on the environment, caused in whole or in part by the Customer, its employees, or subcontractors in disposing waste at this Facility. In the event Customer delivers Unacceptable Waste (as determined by Republic) Customer agrees to assume all expenses and obligations with the removal and/or resolution of any effects caused by the delivery of such Unacceptable Waste.

Indemnización. Cliente acuerda indemnizar, mantener inmune, y defender Republic Services, Inc., sus subsidiarios, compañías, divisiones, empleados, oficiales y directores contra de cualquiera y de todas responsabilidades, demandas, penas, pérdidas, juicios, pleitos y los costos incidente además, incluyendo costos de defensa, de acuerdo judicial, y de honorarios razonables del abogado, que pueden ser incurridos en, o como resultado de, la muerte o herida personal a cualquier persona, o daños a cualquier característica, propiedad, contaminación de la tierra o efectos ilícitos en esta Facilidad, causado entero o en parte por el cliente, sus empleados, o sus subcontratistas en botar basura en esta Facilidad. En el caso que el Cliente entrega, bota, basura (según lo determinado por Republic) en este Establecimiento basura inaceptable en los reglamentos de este Establecimiento, el Cliente se compromete asumir todos los costos y obligaciones con el retiro y/o la resolución de cualquier dano(s) causado por la entrega de tal basura inaceptable.

NON-HAZARDOUS WASTE MANIFEST

1. Generator ID Number
NVD008290330

2. Page 1 of 1

3. Emergency Response Phone
(702) 353-4355

4. Waste Tracking Number
Manifest # **NLE 3621**

5. Generator's Name and Mailing Address
Troxar LLC
P.O. Box 55
Henderson, Nevada 89009 (702) 392-7727

Generator's Site Address (if different than mailing address)
Troxar LLC
560 West Lake Mead Parkway
Henderson, Nevada 89015

6. Transporter 1 Company Name
Las Vegas Paving Corporation NDOT #0191949

U.S. EPA ID Number
NVD986788174

7. Transporter 2 Company Name

U.S. EPA ID Number

8. Designated Facility Name and Site Address
Republic Services of Nevada
Apex, Regional Landfill (702) 423-2128

U.S. EPA ID Number

Profile Number 3825 11 0022

Facility's Phone:

9. Waste Shipping Name and Description	10. Containers		11. Total Quantity	12. Unit Wt./Vol.
	No.	Type		
1. Regulated Asbestos Containing Material Mixed with soil and construction debris		Trk	14yards	
2.			20.55	#
3.				
4.				

13. Special Handling Instructions and Additional Information
Asbestos will be wetted down and loads shall be wrapped in 6-mill visqueen. Avoid opening wrapped loads. Breathing Asbestos is hazardous to your health.
Call (702) 353-4355, David Breault and return to Generator if undeliverable
CCHD Permit #ATP11-010802 Expires 4/7/2011 DAQEM Project #100633

14. GENERATOR'S/OFFEROR'S CERTIFICATION: I hereby declare that the contents of this consignment are fully and accurately described above by the proper shipping name, and are classified, packaged, marked and labeled/placarded, and are in all respects in proper condition for transport according to applicable international and national governmental regulations.

Generator's/Offoror's Printed/Typed Name: **Susan Crowley**
Signature: *Susan Crowley*
Month: Day: Year:

15. International Shipments Import to U.S. Export from U.S.
Port of entry/exit: Date leaving U.S.:

16. Transporter Acknowledgment of Receipt of Materials
Transporter 1 Printed/Typed Name: **Brian Brinkmoff**
Signature: *Brian Brinkmoff*
Month: Day: Year: **7 3 11**
Transporter 2 Printed/Typed Name: Signature: Month: Day: Year:

17. Discrepancy
17a. Discrepancy Indication Space Quantity Type Residue Partial Rejection Full Rejection

Manifest Reference Number: U.S. EPA ID Number

17b. Alternate Facility (or Generator) Facility's Phone:
17c. Signature of Alternate Facility (or Generator) Month: Day: Year:

LVPC Job Number 966525

18. Designated Facility Owner or Operator: Certification of receipt of materials covered by the manifest except as noted in Item 17a
Printed/Typed Name: **Joson Smith**
Signature: *Joson Smith*
Month: Day: Year: **2 3 11**

GENERATOR

TRANSPORTER INT'L

DESIGNATED FACILITY

81 Environmental Tech
13550 N Highway 93
Las Vegas, NV 89165

Ticket Type: INBOUND INVOICE

Ticket Number: 22721
Date: 02/04/2011
Time In: 1:07 am
Time Out: 1:28 am

Customer: 001011 - NGE, LLC c/o Northgate Environ Mgmt

Vehide/Container: 192334
Contract: RZE ASBESTO SOIL 3825 11 0022
Comment: 3825-11-0022

Gross Weight: 80,200 LB Scale In
Tare Weight: 38,220 LB Scale Out
Net Weight: 41980 LB
Net Tons: 20.99

BOL: RZB0622

Origin	Yards	Material	Billing Quantity
Not Applicable	0.00 YD	ASBESTOS FRIABLE	20.99 TN

Driver: _____

Weighmaster: _____

SMITHJ

Indemnification. Customer agrees, by signature above, to indemnify, hold harmless, and defend Republic Services, Inc., its subsidiaries, affiliates, employees, officers and directors from and against any and all liabilities, claims, penalties, forfeitures, suits and the costs and expenses incident thereto, including costs of defense, settlement, and reasonable attorney's fees, which may be incurred, as a result of death or injuries to any person, or damage to any property, contamination of or adverse effects on the environment, caused in whole or in part by the Customer, its employees, or subcontractors in disposing waste at this Facility. In the event Customer delivers Unacceptable Waste (as determined by Republic) Customer agrees to assume all expenses and obligations with the removal and/or resolution of any effects caused by the delivery of such Unacceptable Waste.

Indemnización. Cliente acuerda indemnizar, mantener inmune, y defender Republic Services, Inc., sus subsidiarios, compañías, divisiones, empleados, oficiales y directores contra de cualquiera y de todas responsabilidades, demandas, penas, pérdidas, juicios, pleitos y los costos incidente además, incluyendo costos de defensa, de acuerdo judicial, y de honorarios razonables del abogado, que pueden ser incurridos en, o como resultado de, la muerte o herida personal a cualquier persona, o daños a cualquier característica, propiedad, contaminación de la tierra o efectos ilícitos en esta Facilidad, causado entero o en parte por el cliente, sus empleados, o sus subcontratistas en botar basura en esta Facilidad. En el caso que el Cliente entrega, bota, basura (según lo determinado por Republic) en este Establecimiento basura inaceptable en los reglamentos de este Establecimiento, el Cliente se compromete asumir todos los costos y obligaciones con el retiro y/o la resolución de cualquier dano(s) causado por la entrega de tal basura inaceptable.

NON-HAZARDOUS WASTE MANIFEST

1. Generator ID Number
NVE 980708174

2. Page 1 of 1

3. Emergency Response Phone
(702) 353-4355

4. Waste Tracking Number
Manifest # **WZK 39622**

5. Generator's Name and Mailing Address

Ironax
P.O. Box 55
Henderson, Nevada 89009 (702) 592-7727

Generator's Site Address (if different than mailing address)

Ironax LLC
560 West Lake Mead Parkway
Henderson, Nevada 89015

Generator's Phone:

6. Transporter 1 Company Name
Las Vegas Paving Corporation NDOT #0191949

U.S. EPA ID Number
NVE 980708174

7. Transporter 2 Company Name

U.S. EPA ID Number

8. Designated Facility Name and Site Address

Republic Services of Nevada
Apex, Regional Landfill (702) 423-2128

U.S. EPA ID Number

Profile Number **3825 11 0022**

Facility's Phone:

9. Waste Shipping Name and Description

10. Containers

No.

Type

11. Total Quantity

12. Unit Wt./Vol.

1. **Regulated Asbestos Containing Material**
Mixed with soil and construction debris

Trk

14 yards

2.

20.99

70

3.

4.

13. Special Handling Instructions and Additional Information

Asbestos will be wetted down and loads shall be wrapped in 6-mil visqueen. Avoid opening wrapped loads. Breathing Asbestos is hazardous to your health.
Call (702) 353-4355, David Breault and return to Generator if undeliverable.
CCHD Permit #ATP11-010802 Expires 4/7/2011 **DAQEM Project #100633**

14. GENERATOR'S/OFFEROR'S CERTIFICATION: I hereby declare that the contents of this consignment are fully and accurately described above by the proper shipping name, and are classified, packaged, marked and labeled/placarded, and are in all respects in proper condition for transport according to applicable international and national governmental regulations.

Generator's/Offoror's Printed/Typed Name

Susan Crowley

Signature

Susan Crowley

Month Day Year

15. International Shipments

Import to U.S.

Export from U.S.

Port of entry/exit:

Date leaving U.S.:

Transporter Signature (for exports only):

16. Transporter Acknowledgment of Receipt of Materials

Transporter 1 Printed/Typed Name

Rob Kostick

Signature

[Signature]

Month Day Year

2 3 11

Transporter 2 Printed/Typed Name

Signature

Month Day Year

17. Discrepancy

17a. Discrepancy Indication Space

Quantity

Type

Residue

Partial Rejection

Full Rejection

Manifest Reference Number:

17b. Alternate Facility (or Generator)

U.S. EPA ID Number

Facility's Phone:

17c. Signature of Alternate Facility (or Generator)

Month Day Year

LVPC Job Number 966525

18. Designated Facility Owner or Operator: Certification of receipt of materials covered by the manifest except as noted in Item 17a

Printed/Typed Name

Jesse Smith

Signature

[Signature]

Month Day Year

2 3 11

81 Environmental Tech
13550 N Highway 93
Las Vegas, NV 89165

Ticket Type: INBOUND INVOICE

Ticket Number: 22722
Date: 02/04/2011
Time In: 1:09 am
Time Out: 1:29 am

Customer: 001011 - NGE, LLC c/o Northgate Environ Mgmt

Vehicle/Container: 192310
Contract: RZE ASBESTO SOIL 3825 11 0022
Comment: 3825-11-0022

Gross Weight: 81,400 LB Scale In
Tare Weight: 37,140 LB Scale Out
Net Weight: 44260 LB
Net Tons: 22.13

BOL: RZE0623

Origin	Yards	Material	Billing	Quantity
Not Applicable	0.00 YD	ASBESTOS FRIABLE	22.13	TN

Driver:

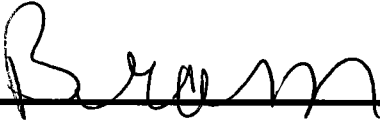

Weighmaster:

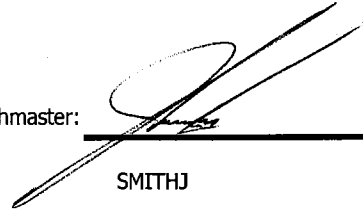
SMITHJ

Indemnification. Customer agrees, by signature above, to indemnify, hold harmless, and defend Republic Services, Inc., its subsidiaries, affiliates, employees, officers and directors from and against any and all liabilities, claims, penalties, forfeitures, suits and the costs and expenses incident thereto, including costs of defense, settlement, and reasonable attorney's fees, which may be incurred, as a result of death or injuries to any person, or damage to any property, contamination of or adverse effects on the environment, caused in whole or in part by the Customer, its employees, or subcontractors in disposing waste at this Facility. In the event Customer delivers Unacceptable Waste (as determined by Republic) Customer agrees to assume all expenses and obligations with the removal and/or resolution of any effects caused by the delivery of such Unacceptable Waste.

Indemnización. Cliente acuerda indemnizar, mantener inmune, y defender Republic Services, Inc., sus subsidiarios, compañías, divisiones, empleados, oficiales y directores contra de cualquiera y de todas responsabilidades, demandas, penas, pérdidas, juicios, pleitos y los costos incidente además, incluyendo costos de defensa, de acuerdo judicial, y de honorarios razonables del abogado, que pueden ser incurridos en, o como resultado de, la muerte o herida personal a cualquier persona, o daños a cualquier característica, propiedad, contaminación de la tierra o efectos ilícitos en esta Facilidad, causado entero o en parte por el cliente, sus empleados, o sus subcontratistas en botar basura en esta Facilidad. En el caso que el Cliente entrega, bota, basura (según lo determinado por Republic) en este Establecimiento basura inaceptable en los reglamentos de este Establecimiento, el Cliente se compromete asumir todos los costos y obligaciones con el retiro y/o la resolución de cualquier dano(s) causado por la entrega de tal basura inaceptable.

NON-HAZARDOUS WASTE MANIFEST

1. Generator ID Number
NVD008290330

2. Page 1 of 1

3. Emergency Response Phone
(702) 353-4355

4. Waste Tracking Number
Manifest # RZE 3623

5. Generator's Name and Mailing Address
Tronox
P.O. Box 55
Henderson, Nevada 89009 (702) 592-7727

Generator's Site Address (if different than mailing address)
Tronox LLC
560 West Lake Mead Parkway
Henderson, Nevada 89015

6. Transporter 1 Company Name
Las Vegas Paving Corporation NDOT #0191949

U.S. EPA ID Number
NVD980788174

7. Transporter 2 Company Name

U.S. EPA ID Number

8. Designated Facility Name and Site Address
Republic Services of Nevada
Apex, Regional Landfill (702) 423-2128

Profile Number **3825 11 0022**

U.S. EPA ID Number

Facility's Phone:

9. Waste Shipping Name and Description

10. Containers
No. Type

11. Total Quantity

12. Unit Wt./Vol.

1. **Regulated Asbestos Containing Material**
Mixed with soil and construction debris

Trk 14yards

2.

22.13 TU

3.

4.

13. Special Handling Instructions and Additional Information

Asbestos will be wetted down and loads shall be wrapped in 6-mill visqueen. Avoid opening wrapped loads. Breathing Asbestos is hazardous to your health.
Call (702) 353-4355, David Breault and return to Generator if undeliverable.
CCHD Permit #ATP11-010802 Expires 4/7/2011 DAQEM Project #100633

14. GENERATOR'S/OFFEROR'S CERTIFICATION: I hereby declare that the contents of this consignment are fully and accurately described above by the proper shipping name, and are classified, packaged, marked and labeled/placarded, and are in all respects in proper condition for transport according to applicable international and national governmental regulations.

Generator's/Offorer's Printed/Typed Name: **Susan Crowley** Signature: *S. Crowley* Month: Day: Year:

15. International Shipments Import to U.S. Export from U.S. Port of entry/exit: Date leaving U.S.:

16. Transporter Acknowledgment of Receipt of Materials
Transporter 1 Printed/Typed Name: *LSM* Signature: Month: Day: Year:

Transporter 2 Printed/Typed Name: Signature: Month: Day: Year:

17. Discrepancy
17a. Discrepancy Indication Space Quantity Type Residue Partial Rejection Full Rejection

Manifest Reference Number: U.S. EPA ID Number

17b. Alternate Facility (or Generator) Facility's Phone: Month: Day: Year:

17c. Signature of Alternate Facility (or Generator) Month: Day: Year:

LVPC Job Number 966525

18. Designated Facility Owner or Operator: Certification of receipt of materials covered by the manifest except as noted in Item 17a
Printed/Typed Name: *Jason Smith* Signature: *J. Smith* Month: Day: Year: **2 3 11**

DESIGNATED FACILITY'S COPY

81 Environmental Tech
13550 N Highway 93
Las Vegas, NV 89165

Ticket Type: INBOUND INVOICE

Ticket Number: 22723
Date: 02/04/2011
Time In: 1:23 am
Time Out: 1:41 am

Customer: 001011 - NGE, LLC c/o Northgate Environ Mgmt

Vehicle/Container: 192312
Contract: RZE ASBESTO SOIL 3825 11 0022
Comment: 3825-11-0022

Gross Weight: 81,000 LB Scale In
Tare Weight: 38,100 LB Scale Out
Net Weight: 42900 LB
Net Tons: 21.45

BOL: RZE0624

Origin	Yards	Material	Billing	Quantity
Not Applicable	0.00 YD	ASBESTOS FRIABLE	21.45	TN

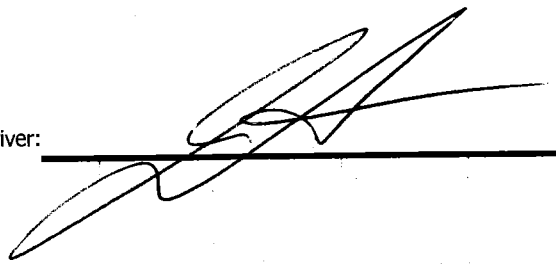
Driver: 

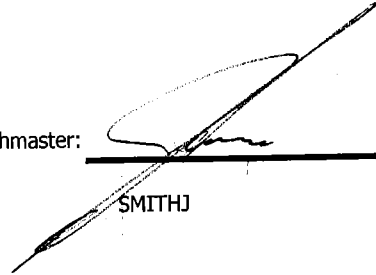
Weighmaster: 
SMITHJ

Indemnification. Customer agrees, by signature above, to indemnify, hold harmless, and defend Republic Services, Inc., its subsidiaries, affiliates, employees, officers and directors from and against any and all liabilities, claims, penalties, forfeitures, suits and the costs and expenses incident thereto, including costs of defense, settlement, and reasonable attorney's fees, which may be incurred, as a result of death or injuries to any person, or damage to any property, contamination of or adverse effects on the environment, caused in whole or in part by the Customer, its employees, or subcontractors in disposing waste at this Facility. In the event Customer delivers Unacceptable Waste (as determined by Republic) Customer agrees to assume all expenses and obligations with the removal and/or resolution of any effects caused by the delivery of such Unacceptable Waste.

Indemnización. Cliente acuerda indemnizar, mantener inmune, y defender Republic Services, Inc., sus subsidiarios, companias, divisiones, empleados, oficiales y directores contra de cualquiera y de todas responsabilidades, demandas, penas, pérdidas, juicios, pleitos y los costos incidente además, incluyendo costos de defensa, de acuerdo judicial, y de honorarios razonables del abogado, que pueden ser incurridos en, o como resultado de, la muerte o herida personal a cualquier persona, o daños a cualquier característica, propiedad, contaminación de la tierra o efectos ilicitos en esta Facilidad, causado entero o en parte por el cliente, sus empleados, o sus subcontratistas en botar basura en esta Facilidad. En el caso que el Cliente entrega, bota, basura (según lo determinado por Republic) en este Establecimiento basura inaceptable en los reglamentos de este Establecimiento, el Cliente se compromete asumir todos los costos y obligaciones con el retiro y/o la resolución de cualquier dano(s) causado por la entrega de tal basura inaceptable.

NON-HAZARDOUS WASTE MANIFEST

1. Generator ID Number
ATP11-010802

2. Page 1 of 1

3. Emergency Response Phone
(702) 353-4355

4. Waste Tracking Number
Manifest # RZE 30624

5. Generator's Name and Mailing Address
Tronick
P.O. Box 55
Henderson, Nevada 89009 (702) 592-7727

Generator's Site Address (if different than mailing address)
Tronick LLC
560 West Lake Mead Parkway
Henderson, Nevada 89015

Generator's Phone:

6. Transporter 1 Company Name
Las Vegas Paving Corporation NDOT #0191949

U.S. EPA ID Number
NVD986768174

7. Transporter 2 Company Name

U.S. EPA ID Number

8. Designated Facility Name and Site Address

Republic Services of Nevada
Apex, Regional Landfill (702) 423-2128

Profile Number **3825 11 0022**

U.S. EPA ID Number

Facility's Phone:

9. Waste Shipping Name and Description

10. Containers

No. Type

11. Total Quantity

12. Unit Wt./Vol.

1. **Regulated Asbestos Containing Material**
Mixed with soil and construction debris

Trk 14yards

2.

21.45 TN

3.

4.

13. Special Handling Instructions and Additional Information

Asbestos will be wetted down and loads shall be wrapped in 6-mil visqueen. Avoid opening wrapped loads. Breathing Asbestos is hazardous to your health.

Call (702) 353-4355, David Breaud and return to Generator if undeliverable.

CCHD Permit #ATP11-010802 Expires 4/7/2011

DAQEM Project #100633

14. GENERATOR'S/OFFEROR'S CERTIFICATION: I hereby declare that the contents of this consignment are fully and accurately described above by the proper shipping name, and are classified, packaged, marked and labeled/placarded, and are in all respects in proper condition for transport according to applicable international and national governmental regulations.

Generator's/Offoror's Printed/Typed Name
Susan Crowley

Signature
Susan Crowley

Month Day Year

15. International Shipments Import to U.S.

Export from U.S.

Port of entry/exit:

Date leaving U.S.:

Transporter Signature (for exports only):

16. Transporter Acknowledgment of Receipt of Materials

Transporter 1 Printed/Typed Name

Signature

Month Day Year

Transporter 2 Printed/Typed Name

Signature

Month Day Year

17. Discrepancy

17a. Discrepancy Indication Space

Quantity

Type

Residue

Partial Rejection

Full Rejection

Manifest Reference Number:

U.S. EPA ID Number

17b. Alternate Facility (or Generator)

Facility's Phone:

17c. Signature of Alternate Facility (or Generator)

Month Day Year

LVPC Job Number 966525

18. Designated Facility Owner or Operator: Certification of receipt of materials covered by the manifest except as noted in Item 17a

Printed/Typed Name

Jason Smith

Signature

Month Day Year

2 8 10

81 Environmental Tech
13550 N Highway 93
Las Vegas, NV 89165

Ticket Type: INBOUND INVOICE

Ticket Number: 22724
Date: 02/04/2011
Time In: 1:35 am
Time Out: 1:55 am

Customer: 001011 - NGE, LLC c/o Northgate Environ Mgmt

Vehicle/Container: 192393
Contract: RZE ASBESTO SOIL 3825 11 0022
Comment: 3825-11-0022

Gross Weight: 87,120 LB Scale In
Tare Weight: 41,560 LB Scale Out
Net Weight: 45560 LB
Net Tons: 22.78

BOL: RZE0625

Origin	Yards	Material	Billing Quantity
Not Applicable	0.00 YD	ASBESTOS FRIABLE	22.78 TN

Driver:

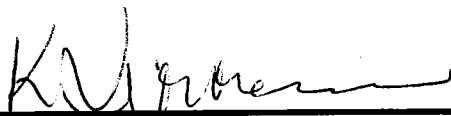

Weighmaster:

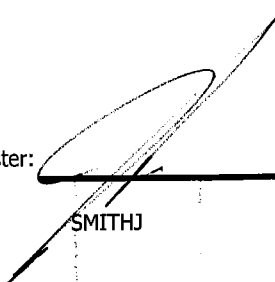
SMITHJ

Indemnification. Customer agrees, by signature above, to indemnify, hold harmless, and defend Republic Services, Inc., its subsidiaries, affiliates, employees, officers and directors from and against any and all liabilities, claims, penalties, forfeitures, suits and the costs and expenses incident thereto, including costs of defense, settlement, and reasonable attorney's fees, which may be incurred, as a result of death or injuries to any person, or damage to any property, contamination of or adverse effects on the environment, caused in whole or in part by the Customer, its employees, or subcontractors in disposing waste at this Facility. In the event Customer delivers Unacceptable Waste (as determined by Republic) Customer agrees to assume all expenses and obligations with the removal and/or resolution of any effects caused by the delivery of such Unacceptable Waste.

Indemnización. Cliente acuerda indemnizar, mantener inmune, y defender Republic Services, Inc., sus subsidiarios, compañías, divisiones, empleados, oficiales y directores contra de cualquiera y de todas responsabilidades, demandas, penas, pérdidas, juicios, pleitos y los costos incidente además, incluyendo costos de defensa, de acuerdo judicial, y de honorarios razonables del abogado, que pueden ser incurridos en, o como resultado de, la muerte o herida personal a cualquier persona, o daños a cualquier característica, propiedad, contaminación de la tierra o efectos ilícitos en esta Facilidad, causado entero o en parte por el cliente, sus empleados, o sus subcontratistas en botar basura en esta Facilidad. En el caso que el Cliente entrega, bota, basura (según lo determinado por Republic) en este Establecimiento basura inaceptable en los reglamentos de este Establecimiento, el Cliente se compromete asumir todos los costos y obligaciones con el retiro y/o la resolución de cualquier dano(s) causado por la entrega de tal basura inaceptable.

NON-HAZARDOUS
WASTE MANIFEST

1. Generator ID Number
NVD008290330

2. Page 1 of 1

3. Emergency Response Phone
(702) 353-4355

4. Waste Tracking Number
Manifest # **RLE 37625**

5. Generator's Name and Mailing Address
Tronox
P.O. Box 55
Henderson, Nevada 89009 (702) 592-7727

Generator's Site Address (if different than mailing address)
Tronox LLC
560 West Lake Mead Parkway
Henderson, Nevada 89015

Generator's Phone:

6. Transporter 1 Company Name
Las Vegas Paving Corporation NDOT #0191949

U.S. EPA ID Number
NVD988768174

7. Transporter 2 Company Name

U.S. EPA ID Number

8. Designated Facility Name and Site Address
Republic Services of Nevada
Apex, Regional Landfill (702) 423-2128

U.S. EPA ID Number
Profile Number 3825 11 0022

Facility's Phone:

9. Waste Shipping Name and Description

10. Containers
No. Type

11. Total Quantity

12. Unit Wt./Vol.

1. **Regulated Asbestos Containing Material**
Mixed with soil and construction debris

Trk 14yards

2.

12.78 TN

3.

4.

13. Special Handling Instructions and Additional Information

Asbestos will be wetted down and loads shall be wrapped in 6-mil visqueen. Avoid opening wrapped loads. Breathing Asbestos is hazardous to your health.

Call (702) 353-4355, David Breault and return to Generator if undeliverable.

CCHD Permit #ATP11-010802 Expires 4/7/2011

DAQEM Project #100633

14. GENERATOR'S/OFFEROR'S CERTIFICATION: I hereby declare that the contents of this consignment are fully and accurately described above by the proper shipping name, and are classified, packaged, marked and labeled/placarded, and are in all respects in proper condition for transport according to applicable international and national governmental regulations.

Generator's/Offoror's Printed/Typed Name
Susan Crowley

Signature
Susan Crowley

Month Day Year

15. International Shipments: Import to U.S. Export from U.S.

Port of entry/exit:
Date leaving U.S.:

16. Transporter Acknowledgment of Receipt of Materials

Transporter 1 Printed/Typed Name
K. Wonnechia

Signature
K. Wonnechia

Month Day Year
12 4 11

17. Discrepancy

17a. Discrepancy Indication Space Quantity Type Residue Partial Rejection Full Rejection

Manifest Reference Number:

U.S. EPA ID Number

17b. Alternate Facility (or Generator)

Facility's Phone:

17c. Signature of Alternate Facility (or Generator)

Month Day Year

LVPC Job Number 966525

18. Designated Facility Owner or Operator: Certification of receipt of materials covered by the manifest except as noted in Item 17a

Printed/Typed Name
John Smith

Signature
John Smith

Month Day Year
2 3 11

81 Environmental Tech
13550 N Highway 93
Las Vegas, NV 89165

Ticket Type: INBOUND INVOICE

Ticket Number: 22725
Date: 02/04/2011
Time In: 1:35 am
Time Out: 1:57 am

Customer: 001011 - NGE, LLC c/o Northgate Environ Mgmt

Vehicle/Container: 192346
Contract: RZE ASBESTO SOIL 3825 11 0022
Comment: 3825-11-0022

Gross Weight: 78,600 LB Scale In
Tare Weight: 36,120 LB Scale Out
Net Weight: 42480 LB
Net Tons: 21.24

BOL: RZE0626

Origin	Yards	Material	Billing	Quantity
Not Applicable	0.00 YD	ASBESTOS FRIABLE	21.24	TN

Driver:

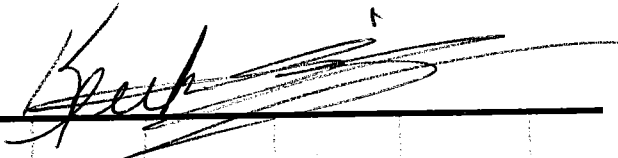

Weighmaster:

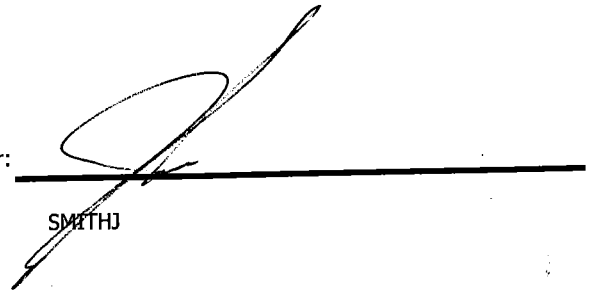

SMITHJ

Indemnification. Customer agrees, by signature above, to indemnify, hold harmless, and defend Republic Services, Inc., its subsidiaries, affiliates, employees, officers and directors from and against any and all liabilities, claims, penalties, forfeitures, suits and the costs and expenses incident thereto, including costs of defense, settlement, and reasonable attorney's fees, which may be incurred, as a result of death or injuries to any person, or damage to any property, contamination of or adverse effects on the environment, caused in whole or in part by the Customer, its employees, or subcontractors in disposing waste at this Facility. In the event Customer delivers Unacceptable Waste (as determined by Republic) Customer agrees to assume all expenses and obligations with the removal and/or resolution of any effects caused by the delivery of such Unacceptable Waste.

Indemnización. Cliente acuerda indemnizar, mantener inmune, y defender Republic Services, Inc., sus subsidiarios, compañías, divisiones, empleados, oficiales y directores contra de cualquiera y de todas responsabilidades, demandas, penas, pérdidas, juicios, pleitos y los costos incidente además, incluyendo costos de defensa, de acuerdo judicial, y de honorarios razonables del abogado, que pueden ser incurridos en, o como resultado de, la muerte o herida personal a cualquier persona, o daños a cualquier característica, propiedad, contaminación de la tierra o efectos ilícitos en esta Facilidad, causado entero o en parte por el cliente, sus empleados, o sus subcontratistas en botar basura en esta Facilidad. En el caso que el Cliente entrega, bota, basura (según lo determinado por Republic) en este Establecimiento basura inaceptable en los reglamentos de este Establecimiento, el Cliente se compromete asumir todos los costos y obligaciones con el retiro y/o la resolución de cualquier dano(s) causado por la entrega de tal basura inaceptable.

NON-HAZARDOUS WASTE MANIFEST

1. Generator's ID Number: **3825110022**

2. Page 1 of 1

3. Emergency Response Phone Number: **(702) 353-4355**

4. Waste Tracking Number: **38026**

5. Generator's Name and Mailing Address

**Iron Horse
P.O. Box 55
Henderson, Nevada 89009 (702) 592-7727**

Generator's Site Address (if different than mailing address)

**560 West Lake Mead Parkway
Henderson, Nevada 89015**

Generator's Phone:

6. Transporter 1 Company Name: **Las Vegas Paving Corporation** NDOT #0191949

U.S. EPA ID Number: **NDOT 0191949**

7. Transporter 2 Company Name:

U.S. EPA ID Number:

8. Designated Facility Name and Site Address

**Republic Services of Nevada
Apex, Regional Landfill (702) 423-2128**

Profile Number 3825 11 0022

U.S. EPA ID Number:

Facility's Phone:

9. Waste Shipping Name and Description

10. Containers

No.

Type

11. Total Quantity

12. Unit Wt./Vol.

1. **Regulated Asbestos Containing Material
Mixed with soil and construction debris**

Trk 14yards

2.

21.24 TL

3.

4.

13. Special Handling Instructions and Additional Information

**Asbestos will be wetted down and loads shall be wrapped in 6-mill visqueen. Avoid opening wrapped loads. Breathing Asbestos is hazardous to your health.
Call (702) 353-4355, David Breatit and return to Generator if undeliverable.
CCHD Permit #ATP11-010802 Expires 4/7/2011 DAQEM Project #100633**

14. GENERATOR'S/OFFEROR'S CERTIFICATION: I hereby declare that the contents of this consignment are fully and accurately described above by the proper shipping name, and are classified, packaged, marked and labeled/placarded, and are in all respects in proper condition for transport according to applicable international and national governmental regulations.

Generator's/Offorer's Printed/Typed Name: **Susan Crowley**

Signature: *Susan Crowley*

Month Day Year

INT'L

15. International Shipments Import to U.S.

Export from U.S.

Port of entry/exit:

Date leaving U.S.:

Transporter Signature (for exports only):

TRANSPORTER

16. Transporter Acknowledgment of Receipt of Materials

Transporter 1 Printed/Typed Name: **Keith Sirevaag**

Signature: *Keith Sirevaag*

Month Day Year

Transporter 2 Printed/Typed Name:

Signature:

Month Day Year

DESIGNATED FACILITY

17. Discrepancy

17a. Discrepancy Indication Space

Quantity

Type

Residue

Partial Rejection

Full Rejection

Manifest Reference Number:

U.S. EPA ID Number:

17b. Alternate Facility (or Generator)

Facility's Phone:

17c. Signature of Alternate Facility (or Generator)

Month Day Year

LVPC Job Number 966525

18. Designated Facility Owner or Operator: Certification of receipt of materials covered by the manifest except as noted in Item 17a

Printed/Typed Name: **Jared Smith**

Signature: *Jared Smith*

Month Day Year

1 3 11

81 Environmental Tech
13550 N Highway 93
Las Vegas, NV 89165

Ticket Type: INBOUND INVOICE

Ticket Number: 22726
Date: 02/04/2011
Time In: 1:45 am
Time Out: 2:04 am

Customer: 001011 - NGE, LLC c/o Northgate Environ Mgmt

Vehicle/Container: 192364
Contract: RZE ASBESTO SOIL 3825 11 0022
Comment: 3825-11-0022

Gross Weight: 81,400 LB Scale In
Tare Weight: 38,080 LB Scale Out
Net Weight: 43320 LB
Net Tons: 21.66

BOL: RZE0627

Origin	Yards	Material	Billing Quantity
Not Applicable	0.00 YD	ASBESTOS FRIABLE	21.66 TN

Driver: _____

Weighmaster: _____

SMITHJ

Indemnification. Customer agrees, by signature above, to indemnify, hold harmless, and defend Republic Services, Inc., its subsidiaries, affiliates, employees, officers and directors from and against any and all liabilities, claims, penalties, forfeitures, suits and the costs and expenses incident thereto, including costs of defense, settlement, and reasonable attorney's fees, which may be incurred, as a result of death or injuries to any person, or damage to any property, contamination of or adverse effects on the environment, caused in whole or in part by the Customer, its employees, or subcontractors in disposing waste at this Facility. In the event Customer delivers Unacceptable Waste (as determined by Republic) Customer agrees to assume all expenses and obligations with the removal and/or resolution of any effects caused by the delivery of such Unacceptable Waste.

Indemnización. Cliente acuerda indemnizar, mantener immune, y defender Republic Services, Inc., sus subsidiarios, compañías, divisiones, empleados, oficiales y directores contra de cualquiera y de todas responsabilidades, demandas, penas, pérdidas, juicios, pleitos y los costos incidente además, incluyendo costos de defensa, de acuerdo judicial, y de honorarios razonables del abogado, que pueden ser incurridos en, o como resultado de, la muerte o herida personal a cualquier persona, o daños a cualquier característica, propiedad, contaminación de la tierra o efectos ilícitos en esta Facilidad, causado entero o en parte por el cliente, sus empleados, o sus subcontratistas en botar basura en esta Facilidad. En el caso que el Cliente entrega, bota, basura (según lo determinado por Republic) en este Establecimiento basura inaceptable en los reglamentos de este Establecimiento, el Cliente se compromete asumir todos los costos y obligaciones con el retiro y/o la resolución de cualquier dano(s) causado por la entrega de tal basura inaceptable.

**NON-HAZARDOUS
WASTE MANIFEST**

1. Generator ID Number
NVD008290330

2. Page 1 of
1

3. Emergency Response Phone
(702) 353-4355

4. Waste Tracking Number
Manifest # RZE 3627

5. Generator's Name and Mailing Address
**Tronox
P.O. Box 55
Henderson, Nevada 89009 (702) 592-7727**

Generator's Site Address (if different than mailing address)
**Tronox LLC
560 West Lake Mead Parkway
Henderson, Nevada 89015**

Generator's Phone:
6. Transporter 1 Company Name
Las Vegas Paving Corporation **NDOT #0191949**

U.S. EPA ID Number
NVD986768174

7. Transporter 2 Company Name

U.S. EPA ID Number

8. Designated Facility Name and Site Address
**Republic Services of Nevada
Apex, Regional Landfill (702) 423-2128**

U.S. EPA ID Number
Profile Number 3825 11 0022

Facility's Phone:

9. Waste Shipping Name and Description	10. Containers		11. Total Quantity	12. Unit Wt./Vol.
	No.	Type		
1. Regulated Asbestos Containing Material Mixed with soil and construction debris		Trk	14yards	
2.			21.66	TU
3.				
4.				

13. Special Handling Instructions and Additional Information

Asbestos will be wetted down and loads shall be wrapped in 6-mil visqueen. Avoid opening wrapped loads. Breathing Asbestos is hazardous to your health.

Call (702) 353-4355, David Breaux and return to Generator if undeliverable.

CCHD Permit #ATP11-010802 Expires 4/7/2011 DAQEM Project #100633

14. GENERATOR'S/OFFEROR'S CERTIFICATION: I hereby declare that the contents of this consignment are fully and accurately described above by the proper shipping name, and are classified, packaged, marked and labeled/placarded, and are in all respects in proper condition for transport according to applicable international and national governmental regulations.

Generator's/Offoror's Printed/Typed Name
Susan Crowley

Signature
S. Crowley

Month Day Year

15. International Shipments Import to U.S. Export from U.S.

Port of entry/exit:

Date leaving U.S.:

Transporter Signature (for exports only):

16. Transporter Acknowledgment of Receipt of Materials

Transporter 1 Printed/Typed Name

Signature

Month Day Year

Transporter 2 Printed/Typed Name

Signature

Month Day Year

17. Discrepancy

17a. Discrepancy Indication Space Quantity Type Residue Partial Rejection Full Rejection

Manifest Reference Number:

U.S. EPA ID Number

17b. Alternate Facility (or Generator)

Facility's Phone:

17c. Signature of Alternate Facility (or Generator)

Month Day Year

LVPC Job Number 966525

18. Designated Facility Owner or Operator: Certification of receipt of materials covered by the manifest except as noted in Item 17a.

Printed/Typed Name
Jason Smith

Signature
J. Smith

Month Day Year
2 8 10

81 Environmental Tech
13550 N Highway 93
Las Vegas, NV 89165

Ticket Type: INBOUND INVOICE

Ticket Number: 22727
Date: 02/04/2011
Time In: 1:44 am
Time Out: 2:07 am

Customer: 001011 - NGE, LLC c/o Northgate Environ Mgmt

Vehicle/Container: 192307
Contract: RZE ASBESTO SOIL 3825 11 0022
Comment: 3825-11-0022

Gross Weight: 82,340 LB Scale In
Tare Weight: 39,520 LB Scale Out
Net Weight: 42820 LB
Net Tons: 21.41

BOL: RZE0628

Origin	Yards	Material	Billing	Quantity
Not Applicable	0.00 YD	ASBESTOS FRIABLE	21.41	TN

Driver: _____



966 525
40 000

Weighmaster: _____

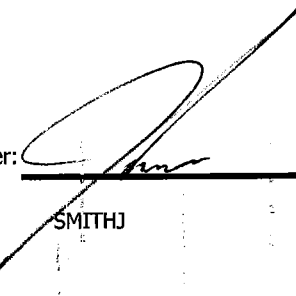

SMITHJ

Indemnification. Customer agrees, by signature above, to indemnify, hold harmless, and defend Republic Services, Inc., its subsidiaries, affiliates, employees, officers and directors from and against any and all liabilities, claims, penalties, forfeitures, suits and the costs and expenses incident thereto, including costs of defense, settlement, and reasonable attorney's fees, which may be incurred, as a result of death or injuries to any person, or damage to any property, contamination of or adverse effects on the environment, caused in whole or in part by the Customer, its employees, or subcontractors in disposing waste at this Facility. In the event Customer delivers Unacceptable Waste (as determined by Republic) Customer agrees to assume all expenses and obligations with the removal and/or resolution of any effects caused by the delivery of such Unacceptable Waste.

Indemnización. Cliente acuerda indemnizar, mantener inmune, y defender Republic Services, Inc., sus subsidiarios, compañías, divisiones, empleados, oficiales y directores contra de cualquiera y de todas responsabilidades, demandas, penas, pérdidas, juicios, pleitos y los costos incidente además, incluyendo costos de defensa, de acuerdo judicial, y de honorarios razonables del abogado, que pueden ser incurridos en, o como resultado de, la muerte o herida personal a cualquier persona, o daños a cualquier característica, propiedad, contaminación de la tierra o efectos ilícitos en esta Facilidad. En el caso que el Cliente entrega, bota, basura (según lo determinado por Republic) en este Establecimiento basura inaceptable en los reglamentos de este Establecimiento, el Cliente se compromete asumir todos los costos y obligaciones con el retiro y/o la resolución de cualquier dano(s) causado por la entrega de tal basura inaceptable.

NON-HAZARDOUS WASTE MANIFEST

1. Generator ID Number
ATP11-010802

2. Page 1 of 1

3. Emergency Response Phone
(702) 353-4355

4. Waste Tracking Number
Manifest # RZLE 3628

5. Generator's Name and Mailing Address

ITRONIX
P.O. Box 55
Henderson, Nevada 89009 (702) 592-7727

Generator's Site Address (if different than mailing address)

ITRONIX LLC
560 West Lake Mead Parkway
Henderson, Nevada 89015

Generator's Phone:

6. Transporter 1 Company Name: **Las Vegas Paving Corporation** DOT #0191949

U.S. EPA ID Number: NV00000768174

7. Transporter 2 Company Name

U.S. EPA ID Number

8. Designated Facility Name and Site Address

Republic Services of Nevada
Apex, Regional Landfill (702) 423-2128

Profile Number **3825 11 0022**

U.S. EPA ID Number

Facility's Phone:

9. Waste Shipping Name and Description

10. Containers

No. Type

11. Total Quantity

12. Unit Wt./Vol.

1. **Regulated Asbestos Containing Material
Mixed with soil and construction debris**

Trk 14yards

21.91 TN

13. Special Handling Instructions and Additional Information

Asbestos will be wetted down and loads shall be wrapped in 6-mil visqueen. Avoid opening wrapped loads. Breathing Asbestos is hazardous to your health.

Call (702) 353-4355, David Breault and return to Generator if undeliverable.

CCHD Permit #ATP11-010802 Expires 4/7/2011 DAQEM Project #100633

14. GENERATOR'S/OFFEROR'S CERTIFICATION: I hereby declare that the contents of this consignment are fully and accurately described above by the proper shipping name, and are classified, packaged, marked and labeled/placarded, and are in all respects in proper condition for transport according to applicable international and national governmental regulations.

Generator's/Offoror's Printed/Typed Name
Susan Crowley

Signature
Susan Crowley

Month Day Year

INT'L

15. International Shipments Import to U.S. Export from U.S.

Port of entry/exit:
Date leaving U.S.:

Transporter Signature (for exports only):

16. Transporter Acknowledgment of Receipt of Materials

Transporter 1 Printed/Typed Name

Mary M Dean

Signature
Mary M Dean

Month Day Year

2 3 11

Transporter 2 Printed/Typed Name

Signature

Month Day Year

17. Discrepancy

17a. Discrepancy Indication Space Quantity Type Residue Partial Rejection Full Rejection

Manifest Reference Number:

U.S. EPA ID Number

17b. Alternate Facility (or Generator)

Facility's Phone:

17c. Signature of Alternate Facility (or Generator)

Month Day Year

DESIGNATED FACILITY

LVPC Job Number 966525

18. Designated Facility Owner or Operator: Certification of receipt of materials covered by the manifest except as noted in Item 17a

Printed/Typed Name

John Smith

Signature

John Smith
(702) 353-4355

Month Day Year

2 8 10

81 Environmental Tech
13550 N Highway 93
Las Vegas, NV 89165

Ticket Type: INBOUND INVOICE

Ticket Number: 22728
Date: 02/04/2011
Time In: 1:51 am
Time Out: 2:11 am

Customer: 001011 - NGE, LLC c/o Northgate Environ Mgmt

Vehicle/Container: 192330 *RZE*
Contract: Northgate Env Asbestos Soils 3825 1
Comment: 3825-11-0022

Gross Weight: 80,500 LB Scale In
Tare Weight: 36,100 LB Scale Out
Net Weight: 44400 LB
Net Tons: 22.20

BOL: RZE0629

Origin	Yards	Material	Billing Quantity
Not Applicable	0.00 YD	ASBESTOS NONFRIABLE	22.20 TN

Driver: 

Weighmaster: 

SMITHJ

Indemnification. Customer agrees, by signature above, to indemnify, hold harmless, and defend Republic Services, Inc., its subsidiaries, affiliates, employees, officers and directors from and against any and all liabilities, claims, penalties, forfeitures, suits and the costs and expenses incident thereto, including costs of defense, settlement, and reasonable attorney's fees, which may be incurred, as a result of death or injuries to any person, or damage to any property, contamination of or adverse effects on the environment, caused in whole or in part by the Customer, its employees, or subcontractors in disposing waste at this Facility. In the event Customer delivers Unacceptable Waste (as determined by Republic) Customer agrees to assume all expenses and obligations with the removal and/or resolution of any effects caused by the delivery of such Unacceptable Waste.

Indemnización. Cliente acuerda indemnizar, mantener inmune, y defender Republic Services, Inc., sus subsidiarios, compañías, divisiones, empleados, oficiales y directores contra de cualquiera y de todas responsabilidades, demandas, penas, pérdidas, juicios, pleitos y los costos incidente además, incluyendo costos de defensa, de acuerdo judicial, y de honorarios razonables del abogado, que pueden ser incurridos en, o como resultado de, la muerte o herida personal a cualquier persona, o daños a cualquier característica, propiedad, contaminación de la tierra o efectos ilícitos en esta Facilidad, causado entero o en parte por el cliente, sus empleados, o sus subcontratistas en botar basura en esta Facilidad. En el caso que el Cliente entrega, bota, basura (según lo determinado por Republic) en este Establecimiento basura inaceptable en los reglamentos de este Establecimiento, el Cliente se compromete asumir todos los costos y obligaciones con el retiro y/o la resolución de cualquier dano(s) causado por la entrega de tal basura inaceptable.

**NON-HAZARDOUS
WASTE MANIFEST**

1. Generator ID Number
NVD00290130

2. Page 1 of
1

3. Emergency Response Phone
(702) 353-4355

4. Waste Tracking Number
Manifest # RLE 38629

5. Generator's Name and Mailing Address
Tronox
P.O. Box 55
Henderson, Nevada 89009 (702) 592-7727

Generator's Site Address (if different than mailing address)
Tronox LLC
560 West Lake Mead Parkway
Henderson, Nevada 89015

Generator's Phone:
6. Transporter 1 Company Name
Las Vegas Paving Corporation NDOT #0191949

U.S. EPA ID Number
NVD986768174

7. Transporter 2 Company Name

U.S. EPA ID Number

8. Designated Facility Name and Site Address
Republic Services of Nevada
Apex, Regional Landfill (702) 423-2128

U.S. EPA ID Number

Profile Number 3825 11 0022

Facility's Phone:

9. Waste Shipping Name and Description	10. Containers		11. Total Quantity	12. Unit Wt./Vol.
	No.	Type		
1. Regulated Asbestos Containing Material Mixed with soil and construction debris		Trk	14yards	
2.			dd.do	RU
3.				
4.				

13. Special Handling Instructions and Additional Information

Asbestos will be wetted down and loads shall be wrapped in 6-mill visqueen. Avoid opening wrapped loads. Breathing Asbestos is hazardous to your health.
Call (702) 353-4355, David Breault and return to Generator if undeliverable.
CCHD Permit #ATP11-010802 Expires 4/7/2011 DAQEM Project #100633

14. GENERATOR'S/OFFEROR'S CERTIFICATION: I hereby declare that the contents of this consignment are fully and accurately described above by the proper shipping name, and are classified, packaged, marked and labeled/placarded, and are in all respects in proper condition for transport according to applicable international and national governmental regulations.

Generator's/Offoror's Printed/Typed Name: Susan Crowley
Signature: *S.M. Crowley*
Month: Day: Year:

15. International Shipments Import to U.S. Export from U.S. Port of entry/exit: Date leaving U.S.:

16. Transporter Acknowledgment of Receipt of Materials
Transporter 1 Printed/Typed Name: Signature: Month: Day: Year:
Transporter 2 Printed/Typed Name: Signature: Month: Day: Year:

17. Discrepancy
17a. Discrepancy Indication Space Quantity Type Residue Partial Rejection Full Rejection

17b. Alternate Facility (or Generator) Manifest Reference Number: U.S. EPA ID Number:

Facility's Phone:
17c. Signature of Alternate Facility (or Generator) Month: Day: Year:

LVPC Job Number 966525

18. Designated Facility Owner or Operator: Certification of receipt of materials covered by the manifest except as noted in Item 17a
Printed/Typed Name: Signature: Month: Day: Year:

81 Environmental Tech
13550 N Highway 93
Las Vegas, NV 89165

Ticket Type: INBOUND INVOICE

Ticket Number: 22827
Date: 02/04/2011
Time In: 7:00 pm
Time Out: 7:20 pm

Customer: 001011 - NGE, LLC c/o Northgate Environ Mgmt

Vehicle/Container: 192392
Contract: RZE ASBESTO SOIL 3825 11 0022
Comment: 3825 11 002

Gross Weight: 91,800 LB Scale In
Tare Weight: 42,300 LB Scale Out
Net Weight: 49500 LB
Net Tons: 24.75

BOL: RZE 0631

Origin	Yards	Material	Billing	Quantity
Not Applicable	0.00 YD	ASBESTOS FRIABLE	24.75	TN

Driver: _____

Weighmaster: _____

phillve

Indemnification. Customer agrees, by signature above, to indemnify, hold harmless, and defend Republic Services, Inc., its subsidiaries, affiliates, employees, officers and directors from and against any and all liabilities, claims, penalties, forfeitures, suits and the costs and expenses incident thereto, including costs of defense, settlement, and reasonable attorney's fees, which may be incurred, as a result of death or injuries to any person, or damage to any property, contamination of or adverse effects on the environment, caused in whole or in part by the Customer, its employees, or subcontractors in disposing waste at this Facility. In the event Customer delivers Unacceptable Waste (as determined by Republic) Customer agrees to assume all expenses and obligations with the removal and/or resolution of any effects caused by the delivery of such Unacceptable Waste.

Indemnización. Cliente acuerda indemnizar, mantener inmune, y defender Republic Services, Inc., sus subsidiarios, compañías, divisiones, empleados, oficiales y directores contra de cualquiera y de todas responsabilidades, demandas, penas, pérdidas, juicios, pleitos y los costos incidente además, incluyendo costos de defensa, de acuerdo judicial, y de honorarios razonables del abogado, que pueden ser incurridos en, o como resultado de, la muerte o herida personal a cualquier persona, o daños a cualquier característica, propiedad, contaminación de la tierra o efectos ilícitos en esta Facilidad, causado entero o en parte por el cliente, sus empleados, o sus subcontratistas en botar basura en esta Facilidad. En el caso que el Cliente entrega, bota, basura (según lo determinado por Republic) en este Establecimiento basura inaceptable en los reglamentos de este Establecimiento, el Cliente se compromete asumir todos los costos y obligaciones con el retiro y/o la resolución de cualquier dano(s) causado por la entrega de tal basura inaceptable.

NON-HAZARDOUS WASTE MANIFEST

1. Generator ID Number
 NV13008290310

2. Page 1 of 1

3. Emergency Response Phone
 (702) 353-4355

4. Waste Tracking Number
 Manifest # RZE 38631

5. Generator's Name and Mailing Address
Tronox
P.O. Box 55
Henderson, Nevada 89009 (702) 592-7727

Generator's Site Address (if different than mailing address)
Tronox LLC
560 West Lake Mead Parkway
Henderson, Nevada 89015

Generator's Phone:

6. Transporter 1 Company Name
Las Vegas Paving Corporation **NDOT #0191949**

U.S. EPA ID Number
NVD986768174

7. Transporter 2 Company Name

U.S. EPA ID Number

8. Designated Facility Name and Site Address

U.S. EPA ID Number

Republic Services of Nevada
Apex, Regional Landfill (702) 423-2128

Profile Number 3825 11 0022

Facility's Phone:

9. Waste Shipping Name and Description

10. Containers

No. Type

11. Total Quantity

12. Unit Wt./Vol.

1. **Regulated Asbestos Containing Material**
Mixed with soil and construction debris

Trk 14yards

T 24.75

13. Special Handling Instructions and Additional Information

Asbestos will be wetted down and loads shall be wrapped in 6-mil visqueen. Avoid opening wrapped loads. Breathing Asbestos is hazardous to your health.

Call (702) 353-4355, David Breault and return to Generator if undeliverable.

CCHD Permit #ATP11-010602 Expires 4/7/2011 DAQEM Project #100633

14. GENERATOR'S/OFFEROR'S CERTIFICATION: I hereby declare that the contents of this consignment are fully and accurately described above by the proper shipping name, and are classified, packaged, marked and labeled/placarded, and are in all respects in proper condition for transport according to applicable international and national governmental regulations.

Generator's/Offoror's Printed/Typed Name
Susan Crowley

Signature

Susan Crowley

Month Day Year

15. International Shipments Import to U.S. Export from U.S.

Port of entry/exit:

Date leaving U.S.:

Transporter Signature (for exports only):

16. Transporter Acknowledgment of Receipt of Materials

Transporter 1 Printed/Typed Name

Signature

Jerry Cauds

Month Day Year

Transporter 2 Printed/Typed Name

Signature

Month Day Year

17. Discrepancy

17a. Discrepancy Indication Space

Quantity

Type

Residue

Partial Rejection

Full Rejection

Manifest Reference Number:

U.S. EPA ID Number

17b. Alternate Facility (or Generator)

Facility's Phone:

17c. Signature of Alternate Facility (or Generator)

Month Day Year

L.V.P.C. Job Number 966525

18. Designated Facility Owner or Operator: Certification of receipt of materials covered by the manifest except as noted in Item 17a

Printed/Typed Name

Signature

VERA PHILLIPS

Month Day Year

12 24 11

DESIGNATED FACILITY'S COPY

81 Environmental Tech
13550 N Highway 93
Las Vegas, NV 89165

Ticket Type: INBOUND INVOICE

Ticket Number: 22828
Date: 02/04/2011
Time In: 7:01 pm
Time Out: 7:21 pm

Customer: 001011 - NGE, LLC c/o Northgate Environ Mgmt

Vehicle/Container: 192369
Contract: RZE ASBESTO SOIL 3825 11 0022
Comment: 3825 11 0022

Gross Weight: 90,040 LB Scale In
Tare Weight: 41,420 LB Scale Out
Net Weight: 48620 LB
Net Tons: 24.31

BOL: RZE 0630

Origin	Yards	Material	Billing	Quantity
Not Applicable	0.00 YD	ASBESTOS FRIABLE	24.31	TN

Driver: _____



Weighmaster: _____

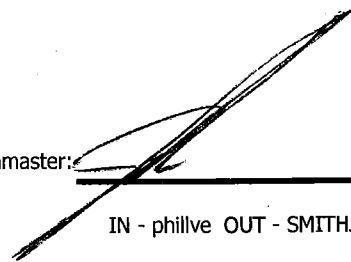

IN - phillve OUT - SMITHJ

Indemnification. Customer agrees, by signature above, to indemnify, hold harmless, and defend Republic Services, Inc., its subsidiaries, affiliates, employees, officers and directors from and against any and all liabilities, claims, penalties, forfeitures, suits and the costs and expenses incident thereto, including costs of defense, settlement, and reasonable attorney's fees, which may be incurred, as a result of death or injuries to any person, or damage to any property, contamination of or adverse effects on the environment, caused in whole or in part by the Customer, its employees, or subcontractors in disposing waste at this Facility. In the event Customer delivers Unacceptable Waste (as determined by Republic) Customer agrees to assume all expenses and obligations with the removal and/or resolution of any effects caused by the delivery of such Unacceptable Waste.

Indemnización. Cliente acuerda indemnizar, mantener inmune, y defender Republic Services, Inc., sus subsidiarios, compañías, divisiones, empleados, oficiales y directores contra de cualquiera y de todas responsabilidades, demandas, penas, pérdidas, juicios, pleitos y los costos incidente además, incluyendo costos de defensa, de acuerdo judicial, y de honorarios razonables del abogado, que pueden ser incurridos en, o como resultado de, la muerte o herida personal a cualquier persona, o daños a cualquier característica, propiedad, contaminación de la tierra o efectos ilícitos en esta Facilidad, causado entero o en parte por el cliente, sus empleados, o sus subcontratistas en botar basura en esta Facilidad. En el caso que el Cliente entrega, bota, basura (según lo determinado por Republic) en este Establecimiento basura inaceptable en los reglamentos de este Establecimiento, el Cliente se compromete asumir todos los costos y obligaciones con el retiro y/o la resolución de cualquier dano(s) causado por la entrega de tal basura inaceptable.

NON-HAZARDOUS WASTE MANIFEST	1. Generator ID Number NVD008290330	2. Page 1 of 1	3. Emergency Response Phone (702) 353-4355	4. Waste Tracking Number Manifest # RZE 38430
5. Generator's Name and Mailing Address Tronox P.O. Box 55 Henderson, Nevada 89009 (702) 592-7727		Generator's Site Address (if different than mailing address) Tronox LLC 560 West Lake Mead Parkway Henderson, Nevada 89015		
6. Transporter 1 Company Name Las Vegas Paving Corporation NDOT #0191949		U.S. EPA ID Number NVD986768174		
7. Transporter 2 Company Name		U.S. EPA ID Number		
8. Designated Facility Name and Site Address Republic Services of Nevada Apex Regional Landfill (702) 423-2128		U.S. EPA ID Number		
Facility's Phone:		Profile Number 3825 11 0022		
9. Waste Shipping Name and Description		10. Containers		11. Total Quantity
		No.	Type	12. Unit Wt./Vol.
1. Regulated Asbestos Containing Material Mixed with soil and construction debris			Trk	14 yards
2.				T 24.31
3.				
4.				
13. Special Handling Instructions and Additional Information Asbestos will be wetted down and loads shall be wrapped in 6-mill visqueen. Avoid opening wrapped loads. Breathing Asbestos is hazardous to your health. Call (702) 353-4355, David Bresuit and return to Generator if undeliverable. CCHD Permit #ATP11-010602 Expires 4/7/2011 DAQEM Project #100633				
14. GENERATOR'S/OFFEROR'S CERTIFICATION: I hereby declare that the contents of this consignment are fully and accurately described above by the proper shipping name, and are classified, packaged, marked and labeled/placarded, and are in all respects in proper condition for transport according to applicable international and national governmental regulations.				
Generator's/Offoror's Printed/Typed Name Susan Crowley		Signature <i>Susan Crowley</i>		Month Day Year
15. International Shipments <input type="checkbox"/> Import to U.S. <input type="checkbox"/> Export from U.S. Port of entry/exit: _____ Transporter Signature (for exports only): _____ Date leaving U.S.: _____				
16. Transporter Acknowledgment of Receipt of Materials				
Transporter 1 Printed/Typed Name <i>Tom Padua</i>		Signature <i>Tom Padua</i>		Month Day Year
Transporter 2 Printed/Typed Name		Signature		Month Day Year
17. Discrepancy				
17a. Discrepancy Indication Space <input type="checkbox"/> Quantity <input type="checkbox"/> Type <input type="checkbox"/> Residue <input type="checkbox"/> Partial Rejection <input type="checkbox"/> Full Rejection				
17b. Alternate Facility (or Generator)		Manifest Reference Number: _____ U.S. EPA ID Number		
Facility's Phone:				
17c. Signature of Alternate Facility (or Generator)		Month Day Year		
LVPC Job Number 966525				
18. Designated Facility Owner or Operator: Certification of receipt of materials covered by the manifest except as noted in Item 17a				
Printed/Typed Name VERA PHILLIPS		Signature <i>Vera Phillips</i>		Month Day Year 12 4 11

81 Environmental Tech
13550 N Highway 93
Las Vegas, NV 89165

Ticket Type: INBOUND INVOICE

Ticket Number: 22829
Date: 02/04/2011
Time In: 7:04 pm
Time Out: 7:23 pm

Customer: 001011 - NGE, LLC c/o Northgate Environ Mgmt

Vehicle/Container: 192367
Contract: RZE ASBESTO SOIL 3825 11 0022
Comment: 3825 11 0022

Gross Weight: 83,040 LB Scale In
Tare Weight: 38,880 LB Scale Out
Net Weight: 44160 LB
Net Tons: 22.08

BOL: RZE 0632

Origin	Yards	Material	Billing	Quantity
Not Applicable	0.00 YD	ASBESTOS FRIABLE	22.08	TN

Driver: T. Richards

Weighmaster: phillve

Indemnification. Customer agrees, by signature above, to indemnify, hold harmless, and defend Republic Services, Inc., its subsidiaries, affiliates, employees, officers and directors from and against any and all liabilities, claims, penalties, forfeitures, suits and the costs and expenses incident thereto, including costs of defense, settlement, and reasonable attorney's fees, which may be incurred, as a result of death or injuries to any person, or damage to any property, contamination of or adverse effects on the environment, caused in whole or in part by the Customer, its employees, or subcontractors in disposing waste at this Facility. In the event Customer delivers Unacceptable Waste (as determined by Republic) Customer agrees to assume all expenses and obligations with the removal and/or resolution of any effects caused by the delivery of such Unacceptable Waste.

Indemnización. Cliente acuerda indemnizar, mantener inmune, y defender Republic Services, Inc., sus subsidiarios, compañías, divisiones, empleados, oficiales y directores contra de cualquiera y de todas responsabilidades, demandas, penas, pérdidas, juicios, pleitos y los costos incidente además, incluyendo costos de defensa, de acuerdo judicial, y de honorarios razonables del abogado, que pueden ser incurridos en, o como resultado de, la muerte o herida personal a cualquier persona, o daños a cualquier característica, propiedad, contaminación de la tierra o efectos ilícitos en esta Facilidad, causado entero o en parte por el cliente, sus empleados, o sus subcontratistas en botar basura en esta Facilidad. En el caso que el Cliente entrega, bota, basura (según lo determinado por Republic) en este Establecimiento basura inaceptable en los reglamentos de este Establecimiento, el Cliente se compromete asumir todos los costos y obligaciones con el retiro y/o la resolución de cualquier dano(s) causado por la entrega de tal basura inaceptable.

NON-HAZARDOUS WASTE MANIFEST 1. Generator ID Number NVD008290330 2. Page 1 of 1 3. Emergency Response Phone (702) 353-4355 4. Waste Tracking Number Manifest # RZE 38632

5. Generator's Name and Mailing Address: Tronox, P.O. Box 53, Henderson, Nevada 89009 (702) 592-7727
 Generator's Site Address (if different than mailing address): Tronox LLC, 560 West Lake Mead Parkway, Henderson, Nevada 89015

6. Transporter 1 Company Name: Las Vegas Paving Corporation, NDOT #0191949
 U.S. EPA ID Number: NVD986768174

7. Transporter 2 Company Name: _____
 U.S. EPA ID Number: _____

8. Designated Facility Name and Site Address: Republic Services of Nevada, Apex, Regional Landfill (702) 423-2128
 Profile Number: 3825 11 0022
 Facility's Phone: _____

9. Waste Shipping Name and Description	10. Containers		11. Total Quantity	12. Unit Wt./Vol.
	No.	Type		
1. Regulated Asbestos Containing Material mixed with soil and construction debris		Trk	14 yards	
2.				T 22.08
3.				
4.				

13. Special Handling Instructions and Additional Information:
 Asbestos will be wetted down and loads shall be wrapped in 6-mill visqueen. Avoid opening wrapped loads. Breathing Asbestos is hazardous to your health.
 Call (702) 353-4355, David Breault and return to Generator if undeliverable.
 CCHD Permit #ATP11-010802 Expires 4/7/2011 DAQEM Project #100633

14. GENERATOR'S/OFFEROR'S CERTIFICATION: I hereby declare that the contents of this consignment are fully and accurately described above by the proper shipping name, and are classified, packaged, marked and labeled/placarded, and are in all respects in proper condition for transport according to applicable international and national governmental regulations.

Generator's/Offeror's Printed/Typed Name: Susan Crowley
 Signature: [Signature]
 Month: _____ Day: _____ Year: _____

15. International Shipments: Import to U.S. Export from U.S.
 Port of entry/exit: _____
 Date leaving U.S.: _____

16. Transporter Acknowledgment of Receipt of Materials
 Transporter 1 Printed/Typed Name: T. Richards
 Signature: [Signature]
 Month: 02 Day: 04 Year: 11
 Transporter 2 Printed/Typed Name: _____
 Signature: _____
 Month: _____ Day: _____ Year: _____

17. Discrepancy

17a. Discrepancy Indication Space: Quantity Type Residue Partial Rejection Full Rejection
 Manifest Reference Number: _____

17b. Alternate Facility (or Generator): _____
 U.S. EPA ID Number: _____
 Facility's Phone: _____

17c. Signature of Alternate Facility (or Generator): _____
 Month: _____ Day: _____ Year: _____

LVPC Job Number 966525

18. Designated Facility Owner or Operator: Certification of receipt of materials covered by the manifest except as noted in Item 17a
 Printed/Typed Name: VERA PHILLIPS
 Signature: [Signature]
 Month: 12 Day: 4 Year: 11

81 Environmental Tech
13550 N Highway 93
Las Vegas, NV 89165

Ticket Type: INBOUND INVOICE

Ticket Number: 22830
Date: 02/04/2011
Time In: 7:08 pm
Time Out: 7:24 pm

Customer: 001011 - NGE, LLC c/o Northgate Environ Mgmt

Vehicle/Container: 192308
Contract: RZE ASBESTO SOIL 3825 11 0022
Comment: 3825 11 0022

Gross Weight: 83,500 LB Scale In
Tare Weight: 40,260 LB Scale Out
Net Weight: 43240 LB
Net Tons: 21.62

BOL: RZE 0633

Origin	Yards	Material	Billing Quantity
Not Applicable	0.00 YD	ASBESTOS FRIABLE	21.62 TN

Driver:

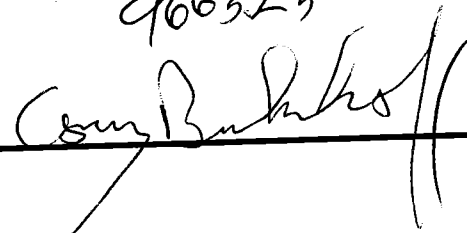
966525

Weighmaster:

IN - phillve OUT - SMITHJ

Indemnification. Customer agrees, by signature above, to indemnify, hold harmless, and defend Republic Services, Inc., its subsidiaries, affiliates, employees, officers and directors from and against any and all liabilities, claims, penalties, forfeitures, suits and the costs and expenses incident thereto, including costs of defense, settlement, and reasonable attorney's fees, which may be incurred, as a result of death or injuries to any person, or damage to any property, contamination of or adverse effects on the environment, caused in whole or in part by the Customer, its employees, or subcontractors in disposing waste at this Facility. In the event Customer delivers Unacceptable Waste (as determined by Republic) Customer agrees to assume all expenses and obligations with the removal and/or resolution of any effects caused by the delivery of such Unacceptable Waste.

Indemnización. Cliente acuerda indemnizar, mantener inmune, y defender Republic Services, Inc., sus subsidiarios, compañías, divisiones, empleados, oficiales y directores contra de cualquiera y de todas responsabilidades, demandas, penas, pérdidas, juicios, pleitos y los costos incidente además, incluyendo costos de defensa, de acuerdo judicial, y de honorarios razonables del abogado, que pueden ser incurridos en, o como resultado de, la muerte o herida personal a cualquier persona, o daños a cualquier característica, propiedad, contaminación de la tierra o efectos ilícitos en esta Facilidad. En el caso que el Cliente entrega, bota, basura (según lo determinado por Republic) en este Establecimiento basura inaceptable en los reglamentos de este Establecimiento, el Cliente se compromete asumir todos los costos y obligaciones con el retiro y/o la resolución de cualquier dano(s) causado por la entrega de tal basura inaceptable.

**NON-HAZARDOUS
WASTE MANIFEST**

1. Generator ID Number
NV15008290330

2. Page 1 of
1

3. Emergency Response Phone
(702) 353-4355

4. Waste Tracking Number
Manifest # RZE 38033

5. Generator's Name and Mailing Address
**Tronox
P.O. Box 55
Henderson, Nevada 89009 (702) 592-7727**

Generator's Site Address (if different than mailing address)
**Tronox LLC
560 West Lake Mead Parkway
Henderson, Nevada 89015**

Generator's Phone:
6. Transporter 1 Company Name
Las Vegas Paving Corporation NDOT #0191949

U.S. EPA ID Number
NVD986768174

7. Transporter 2 Company Name

U.S. EPA ID Number

8. Designated Facility Name and Site Address
**Republic Services of Nevada
Apex, Regional Landfill (702) 423-2128**

Profile Number **3825 11 0022**

U.S. EPA ID Number

Facility's Phone:

9. Waste Shipping Name and Description	10. Containers		11. Total Quantity	12. Unit Wt./Vol.
	No.	Type		
1. Regulated Asbestos Containing Material Mixed with soil and construction debris		Trk	14yards	
2.			2162	TN
3.				
4.				

13. Special Handling Instructions and Additional Information

**Asbestos will be wetted down and loads shall be wrapped in 6-mill visqueen. Avoid opening wrapped loads. Breathing Asbestos is hazardous to your health.
Call (702) 353-4355, David Breault and return to Generator if undeliverable.
CCHD Permit #ATP11-010802 Expires 4/7/2011 DAQEM Project #100633**

14. GENERATOR'S/OFFEROR'S CERTIFICATION: I hereby declare that the contents of this consignment are fully and accurately described above by the proper shipping name, and are classified, packaged, marked and labeled/placarded, and are in all respects in proper condition for transport according to applicable international and national governmental regulations.

Generator's/Offoror's Printed/Typed Name **Susan Crowley** Signature *[Signature]* Month Day Year

GENERATOR
INT'L
TRANSPORTER

15. International Shipments Import to U.S. Export from U.S. Port of entry/exit: _____ Date leaving U.S.: _____

16. Transporter Acknowledgment of Receipt of Materials
Transporter 1 Printed/Typed Name **Cory Brinkerhoff** Signature *[Signature]* Month **2** Day **4** Year **11**
Transporter 2 Printed/Typed Name _____ Signature _____ Month _____ Day _____ Year _____

17. Discrepancy
17a. Discrepancy Indication Space Quantity Type Residue Partial Rejection Full Rejection

Manifest Reference Number: _____ U.S. EPA ID Number _____

17b. Alternate Facility (or Generator) _____

Facility's Phone: _____
17c. Signature of Alternate Facility (or Generator) _____ Month _____ Day _____ Year _____

LVPC Job Number 966525

18. Designated Facility Owner or Operator: Certification of receipt of materials covered by the manifest except as noted in Item 17a
Printed/Typed Name **JASON SMITH** Signature *[Signature]* Month **2** Day **4** Year **11**

DESIGNATED FACILITY'S COPY

81 Environmental Tech
13550 N Highway 93
Las Vegas, NV 89165

Ticket Type: INBOUND INVOICE

Ticket Number: 22831
Date: 02/04/2011
Time In: 7:13 pm
Time Out: 7:31 pm

Customer: 001011 - NGE, LLC c/o Northgate Environ Mgmt

Vehicle/Container: 192358
Contract: RZE ASBESTO SOIL 3825 11 0022
Comment: 3825 11 0022

Gross Weight: 84,300 LB Scale In
Tare Weight: 39,340 LB Scale Out
Net Weight: 44960 LB
Net Tons: 22.48

BOL: RZE 0634

Origin	Yards	Material	Billing Quantity
Not Applicable	0.00 YD	ASBESTOS FRIABLE	22.48 TN

Driver: 

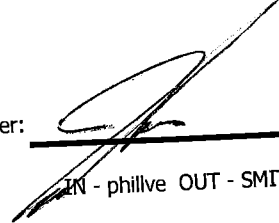
Weighmaster: 
IN - phillve OUT - SMITHJ

Indemnification. Customer agrees, by signature above, to indemnify, hold harmless, and defend Republic Services, Inc., its subsidiaries, affiliates, employees, officers and directors from and against any and all liabilities, claims, penalties, forfeitures, suits and the costs and expenses incident thereto, including costs of defense, settlement, and reasonable attorney's fees, which may be incurred, as a result of death or injuries to any person, or damage to any property, contamination of or adverse effects on the environment, caused in whole or in part by the Customer, its employees, or subcontractors in disposing waste at this Facility. In the event Customer delivers Unacceptable Waste (as determined by Republic) Customer agrees to assume all expenses and obligations with the removal and/or resolution of any effects caused by the delivery of such Unacceptable Waste.

Indemnización. Cliente acuerda indemnizar, mantener immune, y defender Republic Services, Inc., sus subsidiarios, companias, divisiones, empleados, oficiales y directores contra de cualquiera y de todas responsabilidades, demandas, penas, pérdidas, juicios, pleitos y los costos incidente además, incluyendo costos de defensa, de acuerdo judicial, y de honorarios razonables del abogado, que pueden ser incurridos en, o como resultado de, la muerte o herida personal a cualquier persona, o daños a cualquier característica, propiedad, contaminación de la tierra o efectos ilicitos en esta Facilidad, causado entero o en parte por el cliente, sus empleados, o sus subcontratistas en botar basura en esta Facilidad. En el caso que el Cliente entrega, bota, basura (según lo determinado por Republic) en este Establecimiento basura inaceptable en los reglamentos de este Establecimiento, el Cliente se compromete asumir todos los costos y obligaciones con el retiro y/o la resolución de cualquier dano(s) causado por la entrega de tal basura inaceptable.

NON-HAZARDOUS
WASTE MANIFEST

1. Generator ID Number
NVD008290330

2. Page 1 of
1

3. Emergency Response Phone
(702) 353-4355

4. Waste Tracking Number
Manifest # ~~RZE~~ 38634

5. Generator's Name and Mailing Address

~~Tronox~~
P.O. Box 55
Henderson, Nevada 89009 (702) 592-7727

Generator's Site Address (if different than mailing address)

Tronox LLC
560 West Lake Mead Parkway
Henderson, Nevada 89015

6. Transporter 1 Company Name

Las Vegas Paving Corporation NDOT #0191949

U.S. EPA ID Number
NVD986768174

7. Transporter 2 Company Name

U.S. EPA ID Number

8. Designated Facility Name and Site Address

Republic Services of Nevada
Apex, Regional Landfill (702) 423-2128

Profile Number 3825 11 0022

U.S. EPA ID Number

Facility's Phone:

9. Waste Shipping Name and Description

1. Regulated Asbestos Containing Material
Mixed with soil and construction debris

10. Containers

No. Type

Trk 14yards

11. Total
Quantity

12. Unit
Wt./Vol.

2. 48 TN

13. Special Handling Instructions and Additional Information

Asbestos will be wetted down and loads shall be wrapped in 6-mil visqueen. Avoid opening wrapped loads. Breathing Asbestos is hazardous to your health.

Call (702) 353-4355, David Breault and return to Generator if undeliverable.

CCHD Permit #ATP11-010802 Expires 4/7/2011 DAQEM Project #100633

14. GENERATOR'S/OFFEROR'S CERTIFICATION: I hereby declare that the contents of this consignment are fully and accurately described above by the proper shipping name, and are classified, packaged, marked and labeled/placarded, and are in all respects in proper condition for transport according to applicable international and national governmental regulations.

Generator's/Offeror's Printed/Typed Name

Susan Crowley

Signature

Month Day Year

15. International Shipments Import to U.S. Export from U.S.

Port of entry/exit:

Date leaving U.S.:

16. Transporter Acknowledgment of Receipt of Materials

Transporter 1 Printed/Typed Name

Brian Brinkerhoff

Signature

Month Day Year

2 4 11

Transporter 2 Printed/Typed Name

Signature

17. Discrepancy

17a. Discrepancy Indication Space Quantity Type Residue Partial Rejection Full Rejection

Manifest Reference Number:

U.S. EPA ID Number

17b. Alternate Facility (or Generator)

Facility's Phone:

17c. Signature of Alternate Facility (or Generator)

Month Day Year

LVPC Job Number 966525

18. Designated Facility Owner or Operator: Certification of receipt of materials covered by the manifest except as noted in Item 17a

Printed/Typed Name

Jessie Smith

Signature

Month Day Year

2 4 11

DESIGNATED FACILITY'S COPY

81 Environmental Tech
13550 N Highway 93
Las Vegas, NV 89165

Ticket Type: INBOUND INVOICE

Ticket Number: 22832
Date: 02/04/2011
Time In: 7:26 pm
Time Out: 7:43 pm

Customer: 001011 - NGE, LLC c/o Northgate Environ Mgmt

Vehicle/Container: 192391
Contract: RZE ASBESTO SOIL 3825 11 0022
Comment: 3825 11 002 **2**

Gross Weight: 83,920 LB Scale In
Tare Weight: 39,160 LB Scale Out
Net Weight: 44760 LB
Net Tons: 22.38

BOL: RZE 0635

Origin	Yards	Material	Billing	Quantity
Not Applicable	0.00 YD	ASBESTOS FRIABLE	22.38	TN

Driver: _____

Weighmaster: _____

phillve

Indemnification. Customer agrees, by signature above, to indemnify, hold harmless, and defend Republic Services, Inc., its subsidiaries, affiliates, employees, officers and directors from and against any and all liabilities, claims, penalties, forfeitures, suits and the costs and expenses incident thereto, including costs of defense, settlement, and reasonable attorney's fees, which may be incurred, as a result of death or injuries to any person, or damage to any property, contamination of or adverse effects on the environment, caused in whole or in part by the Customer, its employees, or subcontractors in disposing waste at this Facility. In the event Customer delivers Unacceptable Waste (as determined by Republic) Customer agrees to assume all expenses and obligations with the removal and/or resolution of any effects caused by the delivery of such Unacceptable Waste.

Indemnización. Cliente acuerda indemnizar, mantener inmune, y defender Republic Services, Inc., sus subsidiarios, compañías, divisiones, empleados, oficiales y directores contra de cualquiera y de todas responsabilidades, demandas, penas, pérdidas, juicios, pleitos y los costos incidente además, incluyendo costos de defensa, de acuerdo judicial, y de honorarios razonables del abogado, que pueden ser incurridos en, o como resultado de, la muerte o herida personal a cualquier persona, o daños a cualquier característica, propiedad, contaminación de la tierra o efectos ilícitos en esta Facilidad, causado entero o en parte por el cliente, sus empleados, o sus subcontratistas en botar basura en esta Facilidad. En el caso que el Cliente entrega, bota, basura (según lo determinado por Republic) en este Establecimiento basura inaceptable en los reglamentos de este Establecimiento, el Cliente se compromete asumir todos los costos y obligaciones con el retiro y/o la resolución de cualquier dano(s) causado por la entrega de tal basura inaceptable.

NON-HAZARDOUS
WASTE MANIFEST

1. Generator ID Number
NVD008290330

2. Page 1 of 1

3. Emergency Response Phone
(702) 353-4355

4. Waste Tracking Number
Manifest # RZE ~~386~~ 35

5. Generator's Name and Mailing Address
Tronox
P.O. Box 55
Henderson, Nevada 89009 (702) 592-7727

Generator's Site Address (if different than mailing address)
Tronox LLC
500 West Lake Mead Parkway
Henderson, Nevada 89015

6. Transporter 1 Company Name
Las Vegas Paving Corporation NDOT #0191949

U.S. EPA ID Number
NVD985768174

7. Transporter 2 Company Name

U.S. EPA ID Number

8. Designated Facility Name and Site Address
Republic Services of Nevada
Apex, Regional Landfill (702) 423-2128

U.S. EPA ID Number
Profile Number 3825 11 0022

Facility's Phone:

9. Waste Shipping Name and Description

10. Containers
No. Type

11. Total Quantity

12. Unit Wt./Vol.

1. **Regulated Asbestos Containing Material**
Mixed with soil and construction debris

Trk 14yards

T 22.38

13. Special Handling Instructions and Additional Information

Asbestos will be wetted down and loads shall be wrapped in 6-mill visqueen. Avoid opening wrapped loads. Breathing Asbestos is hazardous to your health.
Call (702) 353-4355, David Breault and return to Generator if undeliverable.
CCHD Permit #ATP11-010602 Expires 4/1/2011 DAQEM Project #100633

14. GENERATOR'S/OFFEROR'S CERTIFICATION: I hereby declare that the contents of this consignment are fully and accurately described above by the proper shipping name, and are classified, packaged, marked and labeled/placarded, and are in all respects in proper condition for transport according to applicable international and national governmental regulations.

Generator's/Offeror's Printed/Typed Name: **Susan Crowley** Signature: *Susan Crowley* Month: Day: Year:

15. International Shipments Import to U.S. Export from U.S. Port of entry/exit: Date leaving U.S.:

16. Transporter Acknowledgment of Receipt of Materials

Transporter 1 Printed/Typed Name: Signature: Month: Day: Year:

Transporter 2 Printed/Typed Name: Signature: Month: Day: Year:

17. Discrepancy
17a. Discrepancy Indication Space Quantity Type Residue Partial Rejection Full Rejection

Manifest Reference Number: U.S. EPA ID Number:

17b. Alternate Facility (or Generator): Facility's Phone: U.S. EPA ID Number:

17c. Signature of Alternate Facility (or Generator): Month: Day: Year:

LVPC Job Number 966525

18. Designated Facility Owner or Operator: Certification of receipt of materials covered by the manifest except as noted in Item 17a
Printed/Typed Name: **VERA OHMURA** Signature: *Vera Ohmura* Month: **2** Day: **4** Year: **11**

81 Environmental Tech
13550 N Highway 93
Las Vegas, NV 89165

Ticket Type: INBOUND INVOICE

Ticket Number: 22833
Date: 02/04/2011
Time In: 7:27 pm
Time Out: 7:45 pm

Customer: 001011 - NGE, LLC c/o Northgate Environ Mgmt

Vehicle/Container: 192310
Contract: RZE ASBESTO SOIL 3825 11 0022
Comment: 3825 11 0022

Gross Weight: 82,180 LB Scale In
Tare Weight: 38,600 LB Scale Out
Net Weight: 43580 LB
Net Tons: 21.79

BOL: RZE 0636

Origin	Yards	Material	Billing	Quantity
Not Applicable	0.00 YD	ASBESTOS FRIABLE	21.79	TN

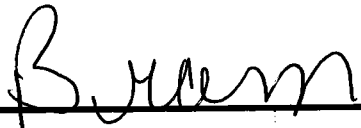
Driver: 

Weighmaster: 
phillve

Indemnification. Customer agrees, by signature above, to indemnify, hold harmless, and defend Republic Services, Inc., its subsidiaries, affiliates, employees, officers and directors from and against any and all liabilities, claims, penalties, forfeitures, suits and the costs and expenses incident thereto, including costs of defense, settlement, and reasonable attorney's fees, which may be incurred, as a result of death or injuries to any person, or damage to any property, contamination of or adverse effects on the environment, caused in whole or in part by the Customer, its employees, or subcontractors in disposing waste at this Facility. In the event Customer delivers Unacceptable Waste (as determined by Republic) Customer agrees to assume all expenses and obligations with the removal and/or resolution of any effects caused by the delivery of such Unacceptable Waste.

Indemnización. Cliente acuerda indemnizar, mantener inmune, y defender Republic Services, Inc., sus subsidiarios, companias, divisiones, empleados, oficiales y directores contra de cualquiera y de todas responsabilidades, demandas, penas, pérdidas, juicios, pleitos y los costos incidente además, incluyendo costos de defensa, de acuerdo judicial, y de honorarios razonables del abogado, que pueden ser incurridos en, o como resultado de, la muerte o herida personal a cualquier persona, o daños a cualquier característica, propiedad, contaminación de la tierra o efectos ilicitos en esta Facilidat. En el caso que el Cliente entrega, bota, basura (según lo determinado por Republic) en este Establecimiento basura inaceptable en los reglamentos de este Establecimiento, el Cliente se compromete asumir todos los costos y obligaciones con el retiro y/o la resolución de cualquier dano(s) causado por la entrega de tal basura inaceptable.

NON-HAZARDOUS WASTE MANIFEST

1. Generator ID Number
NVD00829030

2. Page 1 of 1
 3. Emergency Response Phone
(702) 333-4355

4. Waste Tracking Number
31636

5. Generator's Name and Mailing Address
Tronox
P.O. Box 55
Henderson, Nevada 89009 (702) 592-7727

Generator's Site Address (if different than mailing address)
Tronox LLC
560 West Lake Mead Parkway
Henderson, Nevada 89015

6. Transporter 1 Company Name
Las Vegas Paving Corporation **NDOT #0191949**

U.S. EPA ID Number
NVD986768174

7. Transporter 2 Company Name

U.S. EPA ID Number

8. Designated Facility Name and Site Address
Republic Services of Nevada
Aper, Regional Landfill (702) 423-2128

Profile Number **3825 11 0022**

U.S. EPA ID Number

Facility's Phone:

9. Waste Shipping Name and Description

10. Containers

11. Total Quantity

12. Unit Wt./Vol.

No. Type

1. **Regulated Asbestos Containing Material**
Mixed with soil and construction debris

Trk 14yards

T 21.79

2.

3.

4.

13. Special Handling Instructions and Additional Information

Asbestos will be wetted down and loads shall be wrapped in 6-mill visqueen. Avoid opening wrapped loads. Breathing Asbestos is hazardous to your health.
Call (702) 353-4355, David Breatuit and return to Generator if undeliverable.
CCHD Permit #ATP11-010602. Expires 4/7/2011 DAQEM Project #100633

14. GENERATOR'S/OFFEROR'S CERTIFICATION: I hereby declare that the contents of this consignment are fully and accurately described above by the proper shipping name, and are classified, packaged, marked and labeled/placarded, and are in all respects in proper condition for transport according to applicable international and national governmental regulations.

Generator's/Offoror's Printed/Typed Name: **Susan Crowley** Signature: *[Signature]* Month: Day: Year:

GENERATOR

15. International Shipments Import to U.S. Export from U.S. Port of entry/exit: Date leaving U.S.:

16. Transporter Acknowledgment of Receipt of Materials

Transporter 1 Printed/Typed Name: *[Signature]* Signature: Month: Day: Year:
 Transporter 2 Printed/Typed Name: Signature: Month: Day: Year:

17. Discrepancy

17a. Discrepancy Indication Space Quantity Type Residue Partial Rejection Full Rejection

Manifest Reference Number:

U.S. EPA ID Number

DESIGNATED FACILITY

17b. Alternate Facility (or Generator)

Facility's Phone: Month: Day: Year:
 17c. Signature of Alternate Facility (or Generator):

LVPC Job Number 966525

18. Designated Facility Owner or Operator. Certification of receipt of materials covered by the manifest except as noted in Item 17a

Printed/Typed Name: **VERA PHILLIPS** Signature: *[Signature]* Month: **12** Day: **4** Year: **11**

81 Environmental Tech
13550 N Highway 93
Las Vegas, NV 89165

Ticket Type: INBOUND INVOICE

Ticket Number: 22834
Date: 02/04/2011
Time In: 7:29 pm
Time Out: 7:46 pm

Customer: 001011 - NGE, LLC c/o Northgate Environ Mgmt

Vehicle/Container: 192312
Contract: RZE ASBESTO SOIL 3825 11 0022
Comment: 3825 11 0022

Gross Weight: 79,460 LB Scale In
Tare Weight: 38,400 LB Scale Out
Net Weight: 41060 LB
Net Tons: 20.53

BOL: RZE 0637

Origin	Yards	Material	Billing	Quantity
Not Applicable	0.00 YD	ASBESTOS FRIABLE	20.53	TN

Driver: _____

Weighmaster: _____

phillve

Indemnification. Customer agrees, by signature above, to indemnify, hold harmless, and defend Republic Services, Inc., its subsidiaries, affiliates, employees, officers and directors from and against any and all liabilities, claims, penalties, forfeitures, suits and the costs and expenses incident thereto, including costs of defense, settlement, and reasonable attorney's fees, which may be incurred, as a result of death or injuries to any person, or damage to any property, contamination of or adverse effects on the environment, caused in whole or in part by the Customer, its employees, or subcontractors in disposing waste at this Facility. In the event Customer delivers Unacceptable Waste (as determined by Republic) Customer agrees to assume all expenses and obligations with the removal and/or resolution of any effects caused by the delivery of such Unacceptable Waste.

Indemnización. Cliente acuerda indemnizar, mantener inmune, y defender Republic Services, Inc., sus subsidiarios, compañías, divisiones, empleados, oficiales y directores contra de cualquiera y de todas responsabilidades, demandas, penas, pérdidas, juicios, pleitos y los costos incidente además, incluyendo costos de defensa, de acuerdo judicial, y de honorarios razonables del abogado, que pueden ser incurridos en, o como resultado de, la muerte o herida personal a cualquier persona, o daños a cualquier característica, propiedad, contaminación de la tierra o efectos ilícitos en esta Facilidad, causado entero o en parte por el cliente, sus empleados, o sus subcontratistas en botar basura en esta Facilidad. En el caso que el Cliente entrega, bota, basura (según lo determinado por Republic) en este Establecimiento basura inaceptable en los reglamentos de este Establecimiento, el Cliente se compromete asumir todos los costos y obligaciones con el retiro y/o la resolución de cualquier dano(s) causado por la entrega de tal basura inaceptable.

NON-HAZARDOUS WASTE MANIFEST

1. Generator ID Number
NVD008290330

2. Page 1 of
1

3. Emergency Response Phone
(702) 353-4355

4. Waste Tracking Number
Manifest # RZE 38B7

5. Generator's Name and Mailing Address
Tricon
P.O. Box 55
Henderson, Nevada 89009 (702) 592-7727

Generator's Site Address (if different than mailing address)
Tricon LLC
560 West Lake Mead Parkway
Henderson, Nevada 89015

Generator's Phone:
 6. Transporter 1 Company Name
Las Vegas Paving Corporation **NDOT #0191949**

U.S. EPA ID Number
NVD986768174

7. Transporter 2 Company Name

U.S. EPA ID Number

8. Designated Facility Name and Site Address
Republic Services of Nevada
Apex, Regional Landfill (702) 423-2128

Profile Number **3825 11 0022**

U.S. EPA ID Number

Facility's Phone:

9. Waste Shipping Name and Description	10. Containers		11. Total Quantity	12. Unit Wt./Vol.
	No.	Type		
1. Regulated Asbestos Containing Material Mixed with soil and construction debris		Tik	14yards	
2.				T 20.53
3.				
4.				

13. Special Handling Instructions and Additional Information

Asbestos will be wetted down and loads shall be wrapped in 6-mil visqueen. Avoid opening wrapped loads. Breathing Asbestos is hazardous to your health.
Call (702) 353-4355, David Breault and return to Generator if undeliverable.
CCHD Permit #ATP11-010802 Expires 4/7/2011 DAQEM Project #100633

14. GENERATOR'S/OFFEROR'S CERTIFICATION: I hereby declare that the contents of this consignment are fully and accurately described above by the proper shipping name, and are classified, packaged, marked and labeled/placarded, and are in all respects in proper condition for transport according to applicable international and national governmental regulations.

Generator's/Offoror's Printed/Typed Name: **Susan Crowley** Signature: *[Signature]* Month: Day: Year:

15. International Shipments Import to U.S. Export from U.S. Port of entry/exit: Date leaving U.S.:

16. Transporter Acknowledgment of Receipt of Materials
 Transporter 1 Printed/Typed Name: Signature: Month: Day: Year:
 Transporter 2 Printed/Typed Name: Signature: Month: Day: Year:

17. Discrepancy
 17a. Discrepancy Indication Space Quantity Type Residue Partial Rejection Full Rejection

17b. Alternate Facility (or Generator): Manifest Reference Number: U.S. EPA ID Number:

Facility's Phone: Month: Day: Year:

17c. Signature of Alternate Facility (or Generator): Month: Day: Year:

LVPC Job Number 966525

18. Designated Facility Owner or Operator: Certification of receipt of materials covered by the manifest except as noted in Item 17a
 Printed/Typed Name: **VERA PHILLIPS** Signature: *[Signature]* Month: Day: Year: **12/9/11**

81 Environmental Tech
13550 N Highway 93
Las Vegas, NV 89165

Ticket Type: INBOUND INVOICE

Ticket Number: 22835
Date: 02/04/2011
Time In: 7:36 pm
Time Out: 7:56 pm

Customer: 001011 - NGE, LLC c/o Northgate Environ Mgmt

Vehicle/Container: 192307
Contract: RZE ASBESTO SOIL 3825 11 0022
Comment: 3825 11 0022

Gross Weight: 83,100 LB Scale In
Tare Weight: 39,880 LB Scale Out
Net Weight: 43220 LB
Net Tons: 21.61

BOL: RZE 0638

Origin	Yards	Material	Billing	Quantity
Not Applicable	0.00 YD	ASBESTOS FRIABLE	21.61	TN

Driver: _____

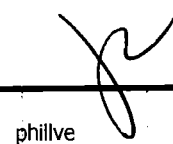

Weighmaster: _____

phillve

Indemnification. Customer agrees, by signature above, to indemnify, hold harmless, and defend Republic Services, Inc., its subsidiaries, affiliates, employees, officers and directors from and against any and all liabilities, claims, penalties, forfeitures, suits and the costs and expenses incident thereto, including costs of defense, settlement, and reasonable attorney's fees, which may be incurred, as a result of death or injuries to any person, or damage to any property, contamination of or adverse effects on the environment, caused in whole or in part by the Customer, its employees, or subcontractors in disposing waste at this Facility. In the event Customer delivers Unacceptable Waste (as determined by Republic) Customer agrees to assume all expenses and obligations with the removal and/or resolution of any effects caused by the delivery of such Unacceptable Waste.

Indemnización. Cliente acuerda indemnizar, mantener inmune, y defender Republic Services, Inc., sus subsidiarios, compañías, divisiones, empleados, oficiales y directores contra de cualquiera y de todas responsabilidades, demandas, penas, pérdidas, juicios, pleitos y los costos incidente además, incluyendo costos de defensa, de acuerdo judicial, y de honorarios razonables del abogado, que pueden ser incurridos en, o como resultado de, la muerte o herida personal a cualquier persona, o daños a cualquier característica, propiedad, contaminación de la tierra o efectos ilícitos en esta Facilidad, causado entero o en parte por el cliente, sus empleados, o sus subcontratistas en botar basura en esta Facilidad. En el caso que el Cliente entrega, bota, basura (según lo determinado por Republic) en este Establecimiento basura inaceptable en los reglamentos de este Establecimiento, el Cliente se compromete asumir todos los costos y obligaciones con el retiro y/o la resolución de cualquier dano(s) causado por la entrega de tal basura inaceptable.

NON-HAZARDOUS WASTE MANIFEST		1. Generator ID Number NVD008290330	2. Page 1 of 1	3. Emergency Response Phone (702) 353-4355	4. Waste Tracking Number Manifest # RZE 30638
5. Generator's Name and Mailing Address Tronox P.O. Box 55 Henderson, Nevada 89009 (702) 592-7727			Generator's Site Address (if different than mailing address) Tronox LLC 560 West Lake Mead Parkway Henderson, Nevada 89015		
6. Transporter 1 Company Name Las Vegas Paving Corporation		NDOT #0191949		U.S. EPA ID Number NVD986768174	
7. Transporter 2 Company Name				U.S. EPA ID Number	
8. Designated Facility Name and Site Address Republic Services of Nevada Apex, Regional Landfill (702) 423-2128				U.S. EPA ID Number	
Facility's Phone:				Profile Number 3825 11 0022	
9. Waste Shipping Name and Description			10. Containers		11. Total Quantity
			No.	Type	12. Unit Wt./Vol.
1. Regulated Asbestos Containing Material Mixed with soil and construction debris				Trk	14yards
2.					T 21.61
3.					
4.					
13. Special Handling Instructions and Additional Information Asbestos will be wetted down and loads shall be wrapped in 6-mil visqueen. Avoid opening wrapped loads. Breathing Asbestos is hazardous to your health. Call (702) 353-4355, David Breaux and return to Generator if undeliverable. CCHD Permit #ATP11-010802. Expires 4/7/2011 DAQEM Project #100633					
14. GENERATOR'S/OFFEROR'S CERTIFICATION: I hereby declare that the contents of this consignment are fully and accurately described above by the proper shipping name, and are classified, packaged, marked and labeled/placarded, and are in all respects in proper condition for transport according to applicable international and national governmental regulations.					
Generator's/Offorer's Printed/Typed Name Susan Crowley			Signature <i>Susan Crowley</i>		Month Day Year
15. International Shipments <input type="checkbox"/> Import to U.S. <input type="checkbox"/> Export from U.S. Port of entry/exit: _____ Date leaving U.S.: _____					
16. Transporter Acknowledgment of Receipt of Materials					
Transporter 1 Printed/Typed Name <i>Mary M Dixon</i>			Signature <i>Mary M Dixon</i>		Month Day Year 2 4 11
Transporter 2 Printed/Typed Name			Signature		Month Day Year
17. Discrepancy					
17a. Discrepancy Indication Space <input type="checkbox"/> Quantity <input type="checkbox"/> Type <input type="checkbox"/> Residue <input type="checkbox"/> Partial Rejection <input type="checkbox"/> Full Rejection					
17b. Alternate Facility (or Generator)				Manifest Reference Number: _____ U.S. EPA ID Number	
Facility's Phone: _____					
17c. Signature of Alternate Facility (or Generator)				Month Day Year	
LVPC Job Number 966525					
18. Designated Facility Owner or Operator: Certification of receipt of materials covered by the manifest except as noted in Item 17a					
Printed/Typed Name VERA PHILLIPS			Signature <i>Vera Phillips</i>		Month Day Year 2 4 11

GENERATOR

INT'L

TRANSPORTER

DESIGNATED FACILITY

81 Environmental Tech
13550 N Highway 93
Las Vegas, NV 89165

Ticket Type: INBOUND INVOICE

Ticket Number: 22836
Date: 02/04/2011
Time In: 7:39 pm
Time Out: 7:59 pm

Customer: 001011 - NGE, LLC c/o Northgate Environ Mgmt

Vehicle/Container: 192393
Contract: RZE ASBESTO SOIL 3825 11 0022
Comment: 3825 11 0022

Gross Weight: 87,640 LB Scale In
Tare Weight: 42,100 LB Scale Out
Net Weight: 45540 LB
Net Tons: 22.77

BOL: RZE 0639

Origin	Yards	Material	Billing	Quantity
Not Applicable	0.00 YD	ASBESTOS FRIABLE	22.77	TN

Driver: _____

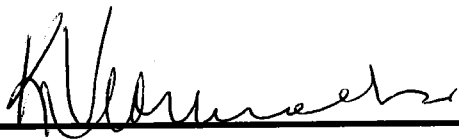

Weighmaster: _____



phillve

Indemnification. Customer agrees, by signature above, to indemnify, hold harmless, and defend Republic Services, Inc., its subsidiaries, affiliates, employees, officers and directors from and against any and all liabilities, claims, penalties, forfeitures, suits and the costs and expenses incident thereto, including costs of defense, settlement, and reasonable attorney's fees, which may be incurred, as a result of death or injuries to any person, or damage to any property, contamination of or adverse effects on the environment, caused in whole or in part by the Customer, its employees, or subcontractors in disposing waste at this Facility. In the event Customer delivers Unacceptable Waste (as determined by Republic) Customer agrees to assume all expenses and obligations with the removal and/or resolution of any effects caused by the delivery of such Unacceptable Waste.

Indemnización. Cliente acuerda indemnizar, mantener inmune, y defender Republic Services, Inc., sus subsidiarios, compañías, divisiones, empleados, oficiales y directores contra de cualquiera y de todas responsabilidades, demandas, penas, pérdidas, juicios, pleitos y los costos incidente además, incluyendo costos de defensa, de acuerdo judicial, y de honorarios razonables del abogado, que pueden ser incurridos en, o como resultado de, la muerte o herida personal a cualquier persona, o daños a cualquier característica, propiedad, contaminación de la tierra o efectos ilícitos en esta Facilidad, causado entero o en parte por el cliente, sus empleados, o sus subcontratistas en botar basura en esta Facilidad. En el caso que el Cliente entrega, bota, basura (según lo determinado por Republic) en este Establecimiento basura inaceptable en los reglamentos de este Establecimiento, el Cliente se compromete asumir todos los costos y obligaciones con el retiro y/o la resolución de cualquier dano(s) causado por la entrega de tal basura inaceptable.

NON-HAZARDOUS WASTE MANIFEST		1. Generator ID Number NVD986768174	2. Page 1 of 1	3. Emergency Response Phone (702) 353-4355	4. Waste Tracking Number Manifest # R21 30639
5. Generator's Name and Mailing Address Tronox P.O. Box 55 Henderson, Nevada 89009 (702) 592-7727			Generator's Site Address (if different than mailing address) Tronox LLC 560 West Lake Mead Parkway Henderson, Nevada 89015		
6. Transporter 1 Company Name Las Vegas Paving Corporation NDOT #0191949			U.S. EPA ID Number NVD986768174		
7. Transporter 2 Company Name			U.S. EPA ID Number		
8. Designated Facility Name and Site Address Republic Services of Nevada Apex, Regional Landfill (702) 423-2128			U.S. EPA ID Number Profile Number 3825 11 0022		
9. Waste Shipping Name and Description			10. Containers	11. Total Quantity	12. Unit Wt./Vol.
			No.	Type	
1. Regulated Asbestos Containing Material Mixed with soil and construction debris				Trk	14yards
2.					T 2277
3.					
4.					
13. Special Handling Instructions and Additional Information Asbestos will be wetted down and loads shall be wrapped in 6-mil visqueen. Avoid opening wrapped loads. Breathing Asbestos is hazardous to your health. Call (702) 353-4355, David Breault and return to Generator if undeliverable. CCHD Permit #ATP11-010802 Expires 4/7/2011 DAQEM Project #100633					
14. GENERATOR'S/OFFEROR'S CERTIFICATION: I hereby declare that the contents of this consignment are fully and accurately described above by the proper shipping name, and are classified, packaged, marked and labeled/placarded, and are in all respects in proper condition for transport according to applicable international and national governmental regulations.					
Generator's/Offoror's Printed/Typed Name Susan Crowley			Signature <i>Susan Crowley</i>		Month Day Year
15. International Shipments <input type="checkbox"/> Import to U.S. <input type="checkbox"/> Export from U.S. Port of entry/exit: _____ Date leaving U.S.: _____					
16. Transporter Acknowledgment of Receipt of Materials					
Transporter 1 Printed/Typed Name <i>Michael</i>			Signature <i>Michael</i>		Month Day Year 2 4 11
Transporter 2 Printed/Typed Name			Signature		Month Day Year
17. Discrepancy					
17a. Discrepancy Indication Space <input type="checkbox"/> Quantity <input type="checkbox"/> Type <input type="checkbox"/> Residue <input type="checkbox"/> Partial Rejection <input type="checkbox"/> Full Rejection					
17b. Alternate Facility (or Generator)			Manifest Reference Number: _____ U.S. EPA ID Number		
17c. Signature of Alternate Facility (or Generator)					
18. Designated Facility Owner or Operator: Certification of receipt of materials covered by the manifest except as noted in Item 17a					
Printed/Typed Name VERA PHILIPS			Signature <i>Vera Philips</i>		Month Day Year 2 4 11

GENERATOR

INT'L

TRANSPORTER

DESIGNATED FACILITY

81 Environmental Tech
13550 N Highway 93
Las Vegas, NV 89165

Ticket Type: INBOUND INVOICE

Ticket Number: 22837
Date: 02/04/2011
Time In: 7:45 pm
Time Out: 8:01 pm

Customer: 001011 - NGE, LLC c/o Northgate Environ Mgmt

Vehicle/Container: 192334
Contract: RZE ASBESTO SOIL 3825 11 0022
Comment: 3825 11 0022

Gross Weight: 79,680 LB Scale In
Tare Weight: 37,640 LB Scale Out
Net Weight: 42040 LB
Net Tons: 21.02

BOL: RZE 0641

Origin	Yards	Material	Billing Quantity
Not Applicable	0.00 YD	ASBESTOS FRIABLE	21.02 TN

Driver: _____

Weighmaster: _____

phillve

Indemnification. Customer agrees, by signature above, to indemnify, hold harmless, and defend Republic Services, Inc., its subsidiaries, affiliates, employees, officers and directors from and against any and all liabilities, claims, penalties, forfeitures, suits and the costs and expenses incident thereto, including costs of defense, settlement, and reasonable attorney's fees, which may be incurred, as a result of death or injuries to any person, or damage to any property, contamination of or adverse effects on the environment, caused in whole or in part by the Customer, its employees, or subcontractors in disposing waste at this Facility. In the event Customer delivers Unacceptable Waste (as determined by Republic) Customer agrees to assume all expenses and obligations with the removal and/or resolution of any effects caused by the delivery of such Unacceptable Waste.

Indemnización. Cliente acuerda indemnizar, mantener inmune, y defender Republic Services, Inc., sus subsidiarios, compañías, divisiones, empleados, oficiales y directores contra de cualquiera y de todas responsabilidades, demandas, penas, pérdidas, juicios, pleitos y los costos incidente además, incluyendo costos de defensa, de acuerdo judicial, y de honorarios razonables del abogado, que pueden ser incurridos en, o como resultado de, la muerte o herida personal a cualquier persona, o daños a cualquier característica, propiedad, contaminación de la tierra o efectos ilícitos en esta Facilidad, causado entero o en parte por el cliente, sus empleados, o sus subcontratistas en botar basura en esta Facilidad. En el caso que el Cliente entrega, bota, basura (según lo determinado por Republic) en este Establecimiento basura inaceptable en los reglamentos de este Establecimiento, el Cliente se compromete asumir todos los costos y obligaciones con el retiro y/o la resolución de cualquier dano(s) causado por la entrega de tal basura inaceptable.

NON-HAZARDOUS WASTE MANIFEST

1. Generator ID Number
NVD008290330

2. Page 1 of 1

3. Emergency Response Phone
(702) 353-4355

4. Waste Tracking Number
Manifest # RZE 39541

5. Generator's Name and Mailing Address
Tronox
P.O. Box 55
Henderson, Nevada 89009 (702) 592-7727

Generator's Site Address (if different than mailing address)
Tronox LLC
560 West Lake Mead Parkway
Henderson, Nevada 89015

Generator's Phone:

6. Transporter 1 Company Name
Las Vegas Paving Corporation NDOT #0191949

U.S. EPA ID Number
NVD986768174

7. Transporter 2 Company Name

U.S. EPA ID Number

8. Designated Facility Name and Site Address

U.S. EPA ID Number

Republic Services of Nevada
Apex, Regional Landfill (702) 423-2128

Profile Number 3825 11 0022

Facility's Phone:

9. Waste Shipping Name and Description	10. Containers		11. Total Quantity	12. Unit Wt./Vol.
	No.	Type		
1. Regulated Asbestos Containing Material Mixed with soil and construction debris		Trk	14yards	
2.				T 21.02
3.				
4.				

13. Special Handling Instructions and Additional Information

Asbestos will be wetted down and loads shall be wrapped in 6-mil visqueen. Avoid opening wrapped loads. Breathing Asbestos is hazardous to your health.

Call (702) 353-4355, David Breault and return to Generator if undeliverable.

CCHD Permit #ATP11-010602 Expires 4/7/2011 DAQEM Project #100633

14. GENERATOR'S/OFFEROR'S CERTIFICATION: I hereby declare that the contents of this consignment are fully and accurately described above by the proper shipping name, and are classified, packaged, marked and labeled/placarded, and are in all respects in proper condition for transport according to applicable international and national governmental regulations.

Generator's/Offoror's Printed/Typed Name: Susan Crowley
Signature: *Susan Crowley*
Month: | Day: | Year: |

15. International Shipments Import to U.S. Export from U.S. Port of entry/exit: | Date leaving U.S.: |

16. Transporter Acknowledgment of Receipt of Materials

Transporter 1 Printed/Typed Name: *AS Kostich* Signature: *AS Kostich* Month: 2 | Day: 4 | Year: 11

Transporter 2 Printed/Typed Name: | Signature: | Month: | Day: | Year: |

17. Discrepancy

17a. Discrepancy Indication Space Quantity Type Residue Partial Rejection Full Rejection

17b. Alternate Facility (or Generator) | Manifest Reference Number: | U.S. EPA ID Number: |

Facility's Phone: |

17c. Signature of Alternate Facility (or Generator) | Month: | Day: | Year: |

LVPC Job Number 966525

18. Designated Facility Owner or Operator: Certification of receipt of materials covered by the manifest except as noted in Item 17a

Printed/Typed Name: *Vera P...* Signature: *Vera P...* Month: 12 | Day: 4 | Year: 11

81 Environmental Tech
13550 N Highway 93
Las Vegas, NV 89165

Ticket Type: INBOUND INVOICE

Ticket Number: 22838
Date: 02/04/2011
Time In: 7:44 pm
Time Out: 8:03 pm

Customer: 001011 - NGE, LLC c/o Northgate Environ Mgmt

Vehicle/Container: 192330 *RZE*
Contract: ~~Northgate Env~~ Asbestos Soils 3825 1
Comment: 3825 11 0022

Gross Weight: 80,240 LB Scale In
Tare Weight: 36,600 LB Scale Out
Net Weight: 43640 LB
Net Tons: 21.82

BOL: RZE 0640

Origin	Yards	Material	Billing	Quantity
Not Applicable	0.00 YD	ASBESTOS NON FRIABLE	21.82	TN

Driver:



Weighmaster:



phillve

Indemnification. Customer agrees, by signature above, to indemnify, hold harmless, and defend Republic Services, Inc., its subsidiaries, affiliates, employees, officers and directors from and against any and all liabilities, claims, penalties, forfeitures, suits and the costs and expenses incident thereto, including costs of defense, settlement, and reasonable attorney's fees, which may be incurred, as a result of death or injuries to any person, or damage to any property, contamination of or adverse effects on the environment, caused in whole or in part by the Customer, its employees, or subcontractors in disposing waste at this Facility. In the event Customer delivers Unacceptable Waste (as determined by Republic) Customer agrees to assume all expenses and obligations with the removal and/or resolution of any effects caused by the delivery of such Unacceptable Waste.

Indemnización. Cliente acuerda indemnizar, mantener inmune, y defender Republic Services, Inc., sus subsidiarios, compañías, divisiones, empleados, oficiales y directores contra de cualquiera y de todas responsabilidades, demandas, penas, pérdidas, juicios, pleitos y los costos incidente además, incluyendo costos de defensa, de acuerdo judicial, y de honorarios razonables del abogado, que pueden ser incurridos en, o como resultado de, la muerte o herida personal a cualquier persona, o daños a cualquier característica, propiedad, contaminación de la tierra o efectos ilícitos en esta Facilidad, causado entero o en parte por el cliente, sus empleados, o sus subcontratistas en botar basura en esta Facilidad. En el caso que el Cliente entrega, bota, basura (según lo determinado por Republic) en este Establecimiento basura inaceptable en los reglamentos de este Establecimiento, el Cliente se compromete asumir todos los costos y obligaciones con el retiro y/o la resolución de cualquier dano(s) causado por la entrega de tal basura inaceptable.

NON-HAZARDOUS WASTE MANIFEST

1. Generator ID Number
NVD008290330

2. Page 1 of
1

3. Emergency Response Phone
(702) 353-4355

4. Waste Tracking Number
Manifest # RZE 3640

5. Generator's Name and Mailing Address

**Tronox
P.O. Box 55
Henderson, Nevada 89009 (702) 592-7727**

Generator's Site Address (if different than mailing address)

**Tronox LLC
560 West Lake Mead Parkway
Henderson, Nevada 89015**

Generator's Phone:

6. Transporter 1 Company Name
Las Vegas Paving Corporation NDOT #0191949

U.S. EPA ID Number
NVD988768174

7. Transporter 2 Company Name

U.S. EPA ID Number

8. Designated Facility Name and Site Address

**Republic Services of Nevada
Apex, Regional Landfill (702) 423-2128**

Profile Number 3825 11 0022

U.S. EPA ID Number

Facility's Phone:

9. Waste Shipping Name and Description

10. Containers

No. Type

11. Total Quantity

12. Unit Wt./Vol.

1. **Regulated Asbestos Containing Material
mixed with soil and construction debris**

Trk 14yards

T 21.82

13. Special Handling Instructions and Additional Information

Asbestos will be wetted down and loads shall be wrapped in 6-mil visqueen. Avoid opening wrapped loads. Breathing Asbestos is hazardous to your health.

Call (702) 353-4355, David Breault and return to Generator if undeliverable.

CCHD Permit #ATP11-010602 Expires 4/7/2011 DAQEM Project #100633

14. GENERATOR'S/OFFEROR'S CERTIFICATION: I hereby declare that the contents of this consignment are fully and accurately described above by the proper shipping name, and are classified, packaged, marked and labeled/placarded, and are in all respects in proper condition for transport according to applicable international and national governmental regulations.

Generator's/Offoror's Printed/Typed Name

Signature

Month Day Year

Susan Crowley

Susan Crowley

15. International Shipments Import to U.S. Export from U.S.

Port of entry/exit:

Transporter Signature (for exports only):

Date leaving U.S.:

16. Transporter Acknowledgment of Receipt of Materials

Transporter 1 Printed/Typed Name

Signature

Month Day Year

Transporter 2 Printed/Typed Name

Signature

Month Day Year

17. Discrepancy

17a. Discrepancy Indication Space

Quantity

Type

Residue

Partial Rejection

Full Rejection

Manifest Reference Number:

17b. Alternate Facility (or Generator)

U.S. EPA ID Number

Facility's Phone:

17c. Signature of Alternate Facility (or Generator)

Month Day Year

LVPC Job Number 966525

18. Designated Facility Owner or Operator: Certification of receipt of materials covered by the manifest except as noted in Item 17a

Printed/Typed Name

Signature

Month Day Year

VERA PHILLIPS

Vera Phillips

12 4 11

81 Environmental Tech
13550 N Highway 93
Las Vegas, NV 89165

Ticket Type: INBOUND INVOICE

Ticket Number: 22839
Date: 02/04/2011
Time In: 8:00 pm
Time Out: 8:19 pm

Customer: 001011 - NGE, LLC c/o Northgate Environ Mgmt

Vehicle/Container: 192346
Contract: RZE ASBESTO SOIL 3825 11 0022
Comment: 3825 11 0022

Gross Weight: 81,880 LB Scale In
Tare Weight: 36,660 LB Scale Out
Net Weight: 45220 LB
Net Tons: 22.61

BOL: RZE 0642

Origin	Yards	Material	Billing	Quantity
Not Applicable	0.00 YD	ASBESTOS FRIABLE	22.61	TN

Driver:

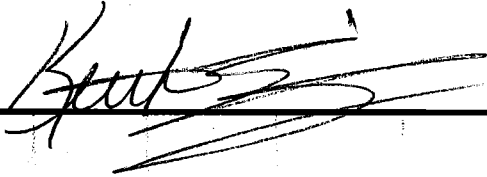

Weighmaster:

phillve

Indemnification. Customer agrees, by signature above, to indemnify, hold harmless, and defend Republic Services, Inc., its subsidiaries, affiliates, employees, officers and directors from and against any and all liabilities, claims, penalties, forfeitures, suits and the costs and expenses incident thereto, including costs of defense, settlement, and reasonable attorney's fees, which may be incurred, as a result of death or injuries to any person, or damage to any property, contamination of or adverse effects on the environment, caused in whole or in part by the Customer, its employees, or subcontractors in disposing waste at this Facility. In the event Customer delivers Unacceptable Waste (as determined by Republic) Customer agrees to assume all expenses and obligations with the removal and/or resolution of any effects caused by the delivery of such Unacceptable Waste.

Indemnización. Cliente acuerda indemnizar, mantener inmune, y defender Republic Services, Inc., sus subsidiarios, compañías, divisiones, empleados, oficiales y directores contra de cualquiera y de todas responsabilidades, demandas, penas, pérdidas, juicios, pleitos y los costos incidente además, incluyendo costos de defensa, de acuerdo judicial, y de honorarios razonables del abogado, que pueden ser incurridos en, o como resultado de, la muerte o herida personal a cualquier persona, o daños a cualquier característica, propiedad, contaminación de la tierra o efectos ilícitos en esta Facilidad, causado entero o en parte por el cliente, sus empleados, o sus subcontratistas en botar basura en esta Facilidad. En el caso que el Cliente entrega, bota, basura (según lo determinado por Republic) en este Establecimiento basura inaceptable en los reglamentos de este Establecimiento, el Cliente se compromete asumir todos los costos y obligaciones con el retiro y/o la resolución de cualquier dano(s) causado por la entrega de tal basura inaceptable.

NON-HAZARDOUS WASTE MANIFEST

1. Generator ID Number
NVD008290330

2. Page 1 of
1

3. Emergency Response Phone
(702) 353-4355

4. Waste Tracking Number
Manifest # **RLE 3642**

5. Generator's Name and Mailing Address
**Tronox
P.O. Box 55
Henderson, Nevada 89009 (702) 592-7727**

Generator's Site Address (if different than mailing address)
**Tronox LLC
560 West Lake Mead Parkway
Henderson, Nevada 89015**

6. Transporter 1 Company Name
Las Vegas Paving Corporation NDOT #0191949

U.S. EPA ID Number
NVD986768174

7. Transporter 2 Company Name

U.S. EPA ID Number

8. Designated Facility Name and Site Address
**Republic Services of Nevada
Apex, Regional Landfill (702) 423-2128**

U.S. EPA ID Number

Profile Number 3825 11 0022

Facility's Phone:

9. Waste Shipping Name and Description	10. Containers		11. Total Quantity	12. Unit Wt./Vol.
	No.	Type		
1. Regulated Asbestos Containing Material Mixed with soil and construction debris		Trk	14yards	
2.				T 2261
3.				
4.				

13. Special Handling Instructions and Additional Information
**Asbestos will be wetted down and loads shall be wrapped in 6-mill visqueen. Avoid opening wrapped loads. Breathing Asbestos is hazardous to your health.
Call (702) 353-4355, David Breault and return to Generator if undeliverable.
CCHD Permit #ATP11-010802 Expires 4/7/2011 DAQEM Project #100633**

14. GENERATOR'S/OFFEROR'S CERTIFICATION: I hereby declare that the contents of this consignment are fully and accurately described above by the proper shipping name, and are classified, packaged, marked and labeled/placarded, and are in all respects in proper condition for transport according to applicable international and national governmental regulations.

Generator's/Offoror's Printed/Typed Name: **Susan Crowley** Signature: *Susan Crowley* Month: Day: Year:

15. International Shipments Import to U.S. Export from U.S. Port of entry/exit: Date leaving U.S.:

16. Transporter Acknowledgment of Receipt of Materials

Transporter 1 Printed/Typed Name: **Keith Sirevaag** Signature: *Keith Sirevaag* Month: Day: Year:

Transporter 2 Printed/Typed Name: Signature: Month: Day: Year:

17. Discrepancy

17a. Discrepancy Indication Space Quantity Type Residue Partial Rejection Full Rejection

Manifest Reference Number: U.S. EPA ID Number:

17b. Alternate Facility (or Generator) U.S. EPA ID Number:

Facility's Phone:

17c. Signature of Alternate Facility (or Generator) Month: Day: Year:

LVPC Job Number 966525

18. Designated Facility Owner or Operator: Certification of receipt of materials covered by the manifest except as noted in Item 17a

Printed/Typed Name: **VERA PHILLIPS** Signature: *Vera Phillips* Month: Day: Year: **2/4/11**

81 Environmental Tech
13550 N Highway 93
Las Vegas, NV 89165

Ticket Type: INBOUND INVOICE

Ticket Number: 22840
Date: 02/04/2011
Time In: 8:55 pm
Time Out: 9:14 pm

Customer: 001011 - NGE, LLC c/o Northgate Environ Mgmt

Vehicle/Container: 192392
Contract: RZE ASBESTO SOIL 3825 11 0022
Comment: 3825 11 0022

Gross Weight: 87,600 LB Scale In
Tare Weight: 41,920 LB Scale Out
Net Weight: 45680 LB
Net Tons: 22.84

BOL: REZ 0643

Origin	Yards	Material	Billing	Quantity
Not Applicable	0.00 YD	ASBESTOS FRIABLE	22.84	TN

Driver: 

Weighmaster: 

phillve

Indemnification. Customer agrees, by signature above, to indemnify, hold harmless, and defend Republic Services, Inc., its subsidiaries, affiliates, employees, officers and directors from and against any and all liabilities, claims, penalties, forfeitures, suits and the costs and expenses incident thereto, including costs of defense, settlement, and reasonable attorney's fees, which may be incurred, as a result of death or injuries to any person, or damage to any property, contamination of or adverse effects on the environment, caused in whole or in part by the Customer, its employees, or subcontractors in disposing waste at this Facility. In the event Customer delivers Unacceptable Waste (as determined by Republic) Customer agrees to assume all expenses and obligations with the removal and/or resolution of any effects caused by the delivery of such Unacceptable Waste.

Indemnización. Cliente acuerda indemnizar, mantener inmune, y defender Republic Services, Inc., sus subsidiarios, companias, divisiones, empleados, oficiales y directores contra de cualquiera y de todas responsabilidades, demandas, penas, pérdidas, juicios, pleitos y los costos incidente además, incluyendo costos de defensa, de acuerdo judicial, y de honorarios razonables del abogado, que pueden ser incurridos en, o como resultado de, la muerte o herida personal a cualquier persona, o daños a cualquier característica, propiedad, contaminación de la tierra o efectos ilicitos en esta Facilidad, causado entero o en parte por el cliente, sus empleados, o sus subcontratistas en botar basura en esta Facilidad. En el caso que el Cliente entrega, bota, basura (según lo determinado por Republic) en este Establecimiento basura inaceptable en los reglamentos de este Establecimiento, el Cliente se compromete asumir todos los costos y obligaciones con el retiro y/o la resolución de cualquier dano(s) causado por la entrega de tal basura inaceptable.

NON-HAZARDOUS WASTE MANIFEST	1. Generator ID Number NVD008290330	2. Page 1 of 1	3. Emergency Response Phone (702) 353-4355	4. Waste Tracking Number Manifest # RZE 31043
5. Generator's Name and Mailing Address Tronox P.O. Box 55 Henderson, Nevada 89009 (702) 592-7727		Generator's Site Address (if different than mailing address) Tronox LLC 560 West Lake Mead Parkway Henderson, Nevada 89015		
6. Transporter 1 Company Name Las Vegas Paving Corporation NDOT #0191949		U.S. EPA ID Number NVD986768174		
7. Transporter 2 Company Name		U.S. EPA ID Number		
8. Designated Facility Name and Site Address Republic Services of Nevada Apex, Regional Landfill (702) 423-2128		U.S. EPA ID Number Profile Number 3825 11 0022		
9. Waste Shipping Name and Description		10. Containers		11. Total Quantity
		No.	Type	12. Unit Wt./Vol.
1. Regulated Asbestos Containing Material Mixed with soil and construction debris			Trk	14yards
2.				T 22 84
3.				
4.				
13. Special Handling Instructions and Additional Information Asbestos will be wetted down and loads shall be wrapped in 6-mil visqueen. Avoid opening wrapped loads. Breathing Asbestos is hazardous to your health. Call (702) 353-4355, David Breault and return to Generator if undeliverable. CCHD Permit #ATP11-010602. Expires 4/7/2011 DAQEM Project #100633				
14. GENERATOR'S/OFFEROR'S CERTIFICATION: I hereby declare that the contents of this consignment are fully and accurately described above by the proper shipping name, and are classified, packaged, marked and labeled/placarded, and are in all respects in proper condition for transport according to applicable international and national governmental regulations.				
Generator's/Offoror's Printed/Typed Name Susan Crowley		Signature <i>Susan Crowley</i>		Month Day Year
15. International Shipments <input type="checkbox"/> Import to U.S. <input type="checkbox"/> Export from U.S. Port of entry/exit: _____ Transporter Signature (for exports only): _____ Date leaving U.S.: _____				
16. Transporter Acknowledgment of Receipt of Materials				
Transporter 1 Printed/Typed Name <i>James Lando</i>		Signature <i>James Lando</i>		Month Day Year
Transporter 2 Printed/Typed Name		Signature		Month Day Year
17. Discrepancy				
17a. Discrepancy Indication Space <input type="checkbox"/> Quantity <input type="checkbox"/> Type <input type="checkbox"/> Residue <input type="checkbox"/> Partial Rejection <input type="checkbox"/> Full Rejection				
17b. Alternate Facility (or Generator) Manifest Reference Number: _____ U.S. EPA ID Number				
17c. Signature of Alternate Facility (or Generator) Month Day Year				
LVPC Job Number 966525				
18. Designated Facility Owner or Operator: Certification of receipt of materials covered by the manifest except as noted in Item 17a				
Printed/Typed Name VERA PHILIP S		Signature <i>Vera Philip S</i>		Month Day Year 12 14 11

GENERATOR

INT'L

TRANSPORTER

DESIGNATED FACILITY

81 Environmental Tech
13550 N Highway 93
Las Vegas, NV 89165

Ticket Type: INBOUND INVOICE

Ticket Number: 22841
Date: 02/04/2011
Time In: 8:58 pm
Time Out: 9:19 pm

Customer: 001011 - NGE, LLC c/o Northgate Environ Mgmt

Vehicle/Container: 192369
Contract: RZE ASBESTO SOIL 3825 11 0022
Comment: 3825 11 0022

Gross Weight: 87,380 LB Scale In
Tare Weight: 41,260 LB Scale Out
Net Weight: 46120 LB
Net Tons: 23.06

BOL: RZE 0644

Origin	Yards	Material	Billing	Quantity
Not Applicable	0.00 YD	ASBESTOS FRIABLE	23.06	TN

Driver:

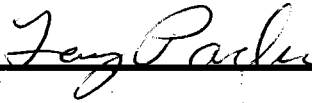

Weighmaster:

phillve

Indemnification. Customer agrees, by signature above, to indemnify, hold harmless, and defend Republic Services, Inc., its subsidiaries, affiliates, employees, officers and directors from and against any and all liabilities, claims, penalties, forfeitures, suits and the costs and expenses incident thereto, including costs of defense, settlement, and reasonable attorney's fees, which may be incurred, as a result of death or injuries to any person, or damage to any property, contamination of or adverse effects on the environment, caused in whole or in part by the Customer, its employees, or subcontractors in disposing waste at this Facility. In the event Customer delivers Unacceptable Waste (as determined by Republic) Customer agrees to assume all expenses and obligations with the removal and/or resolution of any effects caused by the delivery of such Unacceptable Waste.

Indemnización. Cliente acuerda indemnizar, mantener inmune, y defender Republic Services, Inc., sus subsidiarios, compañías, divisiones, empleados, oficiales y directores contra de cualquiera y de todas responsabilidades, demandas, penas, pérdidas, juicios, pleitos y los costos incidente además, incluyendo costos de defensa, de acuerdo judicial, y de honorarios razonables del abogado, que pueden ser incurridos en, o como resultado de, la muerte o herida personal a cualquier persona, o daños a cualquier característica, propiedad, contaminación de la tierra o efectos ilícitos en esta Facilidad, causado entero o en parte por el cliente, sus empleados, o sus subcontratistas en botar basura en esta Facilidad. En el caso que el Cliente entrega, bota, basura (según lo determinado por Republic) en este Establecimiento basura inaceptable en los reglamentos de este Establecimiento, el Cliente se compromete asumir todos los costos y obligaciones con el retiro y/o la resolución de cualquier dano(s) causado por la entrega de tal basura inaceptable.

NON-HAZARDOUS
WASTE MANIFEST

1. Generator ID Number
NVD008290330

2. Page 1 of
1

3. Emergency Response Phone
(702) 353-4355

4. Waste Tracking Number
Manifest # RZE

35844

5. Generator's Name and Mailing Address

Tronox
P.O. Box 55
Henderson, Nevada 89009 (702) 592-7727

Generator's Site Address (if different than mailing address)

Tronox LLC
560 West Lake Mead Parkway
Henderson, Nevada 89015

6. Transporter 1 Company Name

Las Vegas Paving Corporation NDOT #0191949

U.S. EPA ID Number
NVD986768174

7. Transporter 2 Company Name

U.S. EPA ID Number

8. Designated Facility Name and Site Address

Republic Services of Nevada
Apex, Regional Landfill (702) 423-2128

Profile Number 3825 11 0022

U.S. EPA ID Number

Facility's Phone:

9. Waste Shipping Name and Description

10. Containers

No. Type

11. Total Quantity

12. Unit Wt./Vol.

1. Regulated Asbestos Containing Material
mixed with soil and construction debris

Trk 14yards

T 2306

3.

4.

13. Special Handling Instructions and Additional Information

Asbestos will be wetted down and loads shall be wrapped in 6-mill visqueen. Avoid opening wrapped loads. Breathing Asbestos is hazardous to your health.
Call (702) 353-4355, David Breault and return to Generator if undeliverable.
CCHD Permit #ATP11-010802 Expires 4/7/2011 DAQEM Project #100633

14. GENERATOR'S/OFFEROR'S CERTIFICATION: I hereby declare that the contents of this consignment are fully and accurately described above by the proper shipping name, and are classified, packaged, marked and labeled/placarded, and are in all respects in proper condition for transport according to applicable international and national governmental regulations.

Generator's/Offeror's Printed/Typed Name

Susan Crowley

Signature

Month Day Year

15. International Shipments

Import to U.S.

Export from U.S.

Port of entry/exit:

Date leaving U.S.:

16. Transporter Acknowledgment of Receipt of Materials

Transporter 1 Printed/Typed Name

Signature

Month Day Year

Transporter 2 Printed/Typed Name

Signature

Month Day Year

17. Discrepancy

17a. Discrepancy Indication Space

Quantity

Type

Residue

Partial Rejection

Full Rejection

Manifest Reference Number:

17b. Alternate Facility (or Generator)

U.S. EPA ID Number

Facility's Phone:

17c. Signature of Alternate Facility (or Generator)

Month Day Year

LVPC Job Number 966525

18. Designated Facility Owner or Operator: Certification of receipt of materials covered by the manifest except as noted in Item 17a

Printed/Typed Name

VERA ANILIPS

Signature

Month Day Year

12/4/11

81 Environmental Tech
13550 N Highway 93
Las Vegas, NV 89165

Ticket Type: INBOUND INVOICE

Ticket Number: 22842
Date: 02/04/2011
Time In: 9:04 pm
Time Out: 9:22 pm

Customer: 001011 - NGE, LLC c/o Northgate Environ Mgmt

Vehicle/Container: 192367
Contract: RZE ASBESTO SOIL 3825 11 0022
Comment: 3825 11 0022

Gross Weight: 81,940 LB Scale In
Tare Weight: 38,780 LB Scale Out
Net Weight: 43160 LB
Net Tons: 21.58

BOL: RZE 0645

Origin	Yards	Material	Billing	Quantity
Not Applicable	0.00 YD	ASBESTOS FRIABLE	21.58	TN

Driver:

T. Richards

Weighmaster:

phillve

Indemnification. Customer agrees, by signature above, to indemnify, hold harmless, and defend Republic Services, Inc., its subsidiaries, affiliates, employees, officers and directors from and against any and all liabilities, claims, penalties, forfeitures, suits and the costs and expenses incident thereto, including costs of defense, settlement, and reasonable attorney's fees, which may be incurred, as a result of death or injuries to any person, or damage to any property, contamination of or adverse effects on the environment, caused in whole or in part by the Customer, its employees, or subcontractors in disposing waste at this Facility. In the event Customer delivers Unacceptable Waste (as determined by Republic) Customer agrees to assume all expenses and obligations with the removal and/or resolution of any effects caused by the delivery of such Unacceptable Waste.

Indemnización. Cliente acuerda indemnizar, mantener inmune, y defender Republic Services, Inc., sus subsidiarios, compañías, divisiones, empleados, oficiales y directores contra de cualquiera y de todas responsabilidades, demandas, penas, pérdidas, juicios, pleitos y los costos incidente además, incluyendo costos de defensa, de acuerdo judicial, y de honorarios razonables del abogado, que pueden ser incurridos en, o como resultado de, la muerte o herida personal a cualquier persona, o daños a cualquier característica, propiedad, contaminación de la tierra o efectos ilícitos en esta Facilidad, causado entero o en parte por el cliente, sus empleados, o sus subcontratistas en botar basura en esta Facilidad. En el caso que el Cliente entrega, bota, basura (según lo determinado por Republic) en este Establecimiento basura inaceptable en los reglamentos de este Establecimiento, el Cliente se compromete asumir todos los costos y obligaciones con el retiro y/o la resolución de cualquier dano(s) causado por la entrega de tal basura inaceptable.

NON-HAZARDOUS WASTE MANIFEST

1. Generator ID Number
NVD008290330

2. Page 1 of 1

3. Emergency Response Phone
(702) 353-4355

4. Waste Tracking Number
Manifest # **RZE 39045**

5. Generator's Name and Mailing Address
Tronox
P.O. Box 55
Henderson, Nevada 89009 (702) 592-7727

Generator's Site Address (if different than mailing address)
Tronox LLC
560 West Lake Mead Parkway
Henderson, Nevada 89015

6. Transporter 1 Company Name
Las Vegas Paving Corporation NDOT #0191949

U.S. EPA ID Number
NVD980768174

7. Transporter 2 Company Name

U.S. EPA ID Number

8. Designated Facility Name and Site Address
Republic Services of Nevada
Apex, Regional Landfill (702) 423-2128

U.S. EPA ID Number
Profile Number 3825 11 0022

Facility's Phone:

9. Waste Shipping Name and Description

10. Containers

No. Type

11. Total Quantity

12. Unit Wt./Vol.

1. **Regulated Asbestos Containing Material**
Mixed with soil and construction debris

Trk 14yards

T 21.58

13. Special Handling Instructions and Additional Information

Asbestos will be wetted down and loads shall be wrapped in 6-mil visqueen. Avoid opening wrapped loads. Breathing Asbestos is hazardous to your health.
Call (702) 353-4355, David Breault and return to Generator if undeliverable.
CCHD Permit #ATP11-010802 Expires 4/7/2011 DAQEM Project #100633

14. GENERATOR'S/OFFEROR'S CERTIFICATION: I hereby declare that the contents of this consignment are fully and accurately described above by the proper shipping name, and are classified, packaged, marked and labeled/placarded, and are in all respects in proper condition for transport according to applicable international and national governmental regulations.

Generator's/Offoror's Printed/Typed Name
Susan Crowley

Signature
Susan Crowley

Month Day Year

15. International Shipments Import to U.S. Export from U.S.

Port of entry/exit:

Transporter Signature (for exports only):

Date leaving U.S.:

16. Transporter Acknowledgment of Receipt of Materials

Transporter 1 Printed/Typed Name

Signature
T. Richards

Month Day Year

Transporter 2 Printed/Typed Name

Signature

Month Day Year

17. Discrepancy

17a. Discrepancy Indication Space Quantity Type Residue Partial Rejection Full Rejection

Manifest Reference Number:

17b. Alternate Facility (or Generator)

U.S. EPA ID Number

Facility's Phone:

17c. Signature of Alternate Facility (or Generator)

LVP Job Number 966525

Month Day Year

18. Designated Facility Owner or Operator: Certification of receipt of materials covered by the manifest except as noted in Item 17a

Printed/Typed Name

Signature
J. Phillips

Month Day Year

81 Environmental Tech
13550 N Highway 93
Las Vegas, NV 89165

Ticket Type: INBOUND INVOICE

Ticket Number: 22843
Date: 02/04/2011
Time In: 9:07 pm
Time Out: 9:27 pm

Customer: 001011 - NGE, LLC c/o Northgate Environ Mgmt

Vehicle/Container: 192358
Contract: RZE ASBESTO SOIL 3825 11 0022
Comment: 3825 11 0022

Gross Weight: 80,400 LB Scale In
Tare Weight: 39,220 LB Scale Out
Net Weight: 41180 LB
Net Tons: 20.59

BOL: RZE 646

Origin	Yards	Material	Billing	Quantity
Not Applicable	0.00 YD	ASBESTOS FRIABLE	20.59	TN

Driver: 

Weighmaster: 

phillve

Indemnification. Customer agrees, by signature above, to indemnify, hold harmless, and defend Republic Services, Inc., its subsidiaries, affiliates, employees, officers and directors from and against any and all liabilities, claims, penalties, forfeitures, suits and the costs and expenses incident thereto, including costs of defense, settlement, and reasonable attorney's fees, which may be incurred, as a result of death or injuries to any person, or damage to any property, contamination of or adverse effects on the environment, caused in whole or in part by the Customer, its employees, or subcontractors in disposing waste at this Facility. In the event Customer delivers Unacceptable Waste (as determined by Republic) Customer agrees to assume all expenses and obligations with the removal and/or resolution of any effects caused by the delivery of such Unacceptable Waste.

Indemnización. Cliente acuerda indemnizar, mantener inmune, y defender Republic Services, Inc., sus subsidiarios, compañías, divisiones, empleados, oficiales y directores contra de cualquiera y de todas responsabilidades, demandas, penas, pérdidas, juicios, pleitos y los costos incidente además, incluyendo costos de defensa, de acuerdo judicial, y de honorarios razonables del abogado, que pueden ser incurridos en, o como resultado de, la muerte o herida personal a cualquier persona, o daños a cualquier característica, propiedad, contaminación de la tierra o efectos ilícitos en esta Facilidad, causado entero o en parte por el cliente, sus empleados, o sus subcontratistas en botar basura en esta Facilidad. En el caso que el Cliente entrega, bota, basura (según lo determinado por Republic) en este Establecimiento basura inaceptable en los reglamentos de este Establecimiento, el Cliente se compromete asumir todos los costos y obligaciones con el retiro y/o la resolución de cualquier dano(s) causado por la entrega de tal basura inaceptable.

NVD0098290330

(702) 353-4355

Manifest # RZE

46346

NON-HAZARDOUS WASTE MANIFEST		1. Generator ID Number	2. Page 1 of	3. Emergency Response Phone	4. Waste Tracking Number
5. Generator's Name and Mailing Address Tronox P.O. Box 55 Henderson, Nevada 89009 (702) 592-7727			Generator's Site Address (if different than mailing address) Tronox LLC 560 West Lake Mead Parkway Henderson, Nevada 89015		
6. Transporter 1 Company Name Las Vegas Paving Corporation		NDOT #0191949		U.S. EPA ID Number NVD986768174	
7. Transporter 2 Company Name		U.S. EPA ID Number			
8. Designated Facility Name and Site Address Republic Services of Nevada Apex, Regional Landfill (702) 423-2128				U.S. EPA ID Number	
Facility's Profile Number: 3825 11 0022					
GENERATOR	9. Waste Shipping Name and Description		10. Containers		11. Total Quantity
			No.	Type	12. Unit Wt./Vol.
	1.	Regulated Asbestos Containing Material Mixed with soil and construction debris		Trk	14yards
	2.				T 20.59
	3.				
4.					
13. Special Handling Instructions and Additional Information Asbestos will be wetted down and loads shall be wrapped in 6-mill visqueen. Avoid opening wrapped loads. Breathing Asbestos is hazardous to your health. Call (702) 353-4355, David Breault and return to Generator if undeliverable. CCHD Permit #ATP11-010802. Expires 4/7/2011 DAQEM Project #100633					
14. GENERATOR'S/OFFEROR'S CERTIFICATION: I hereby declare that the contents of this consignment are fully and accurately described above by the proper shipping name, and are classified, packaged, marked and labeled/placarded, and are in all respects in proper condition for transport according to applicable international and national governmental regulations.					
Generator's/Offorer's Printed/Typed Name Susan Crowley		Signature <i>Susan Crowley</i>		Month	Day Year
15. International Shipments <input type="checkbox"/> Import to U.S. <input type="checkbox"/> Export from U.S.		Port of entry/exit:		Date leaving U.S.:	
16. Transporter Acknowledgment of Receipt of Materials		Signature		Month	Day Year
Transporter 1 Printed/Typed Name Brian Brinkerhoff		<i>Brian Brinkerhoff</i>		2	4 11
Transporter 2 Printed/Typed Name		Signature		Month	Day Year
17. Discrepancy					
17a. Discrepancy Indication Space <input type="checkbox"/> Quantity <input type="checkbox"/> Type <input type="checkbox"/> Residue <input type="checkbox"/> Partial Rejection <input type="checkbox"/> Full Rejection					
17b. Alternate Facility (or Generator)				U.S. EPA ID Number	
Facility's Phone:					
17c. Signature of Alternate Facility (or Generator)				Month	Day Year
LVPC Job Number 966525					
18. Designated Facility Owner or Operator: Certification of receipt of materials covered by the manifest except as noted in Item 17a					
Printed/Typed Name KEVIN PHILLIPS		Signature <i>Kevin Phillips</i>		Month	Day Year
				2	4 11

81 Environmental Tech
13550 N Highway 93
Las Vegas, NV 89165

Ticket Type: INBOUND INVOICE

Ticket Number: 22844
Date: 02/04/2011
Time In: 9:21 pm
Time Out: 9:38 pm

Customer: 001011 - NGE, LLC c/o Northgate Environ Mgmt

Vehicle/Container: 192310
Contract: RZE ASBESTO SOIL 3825 11 0022
Comment: 3825 11 0022

Gross Weight: 81,920 LB Scale In
Tare Weight: 38,560 LB Scale Out
Net Weight: 43360 LB
Net Tons: 21.68

BOL: RZE 0648

Origin	Yards	Material	Billing	Quantity
Not Applicable	0.00 YD	ASBESTOS FRIABLE	21.68	TN

Driver: 

Weighmaster: 

phillve

Indemnification. Customer agrees, by signature above, to indemnify, hold harmless, and defend Republic Services, Inc., its subsidiaries, affiliates, employees, officers and directors from and against any and all liabilities, claims, penalties, forfeitures, suits and the costs and expenses incident thereto, including costs of defense, settlement, and reasonable attorney's fees, which may be incurred, as a result of death or injuries to any person, or damage to any property, contamination of or adverse effects on the environment, caused in whole or in part by the Customer, its employees, or subcontractors in disposing waste at this Facility. In the event Customer delivers Unacceptable Waste (as determined by Republic) Customer agrees to assume all expenses and obligations with the removal and/or resolution of any effects caused by the delivery of such Unacceptable Waste.

Indemnización. Cliente acuerda indemnizar, mantener inmune, y defender Republic Services, Inc., sus subsidiarios, compañías, divisiones, empleados, oficiales y directores contra de cualquiera y de todas responsabilidades, demandas, penas, pérdidas, juicios, pleitos y los costos incidente además, incluyendo costos de defensa, de acuerdo judicial, y de honorarios razonables del abogado, que pueden ser incurridos en, o como resultado de, la muerte o herida personal a cualquier persona, o daños a cualquier característica, propiedad, contaminación de la tierra o efectos ilícitos en esta Facilidad, causado entero o en parte por el cliente, sus empleados, o sus subcontratistas en botar basura en esta Facilidad. En el caso que el Cliente entrega, bota, basura (según lo determinado por Republic) en este Establecimiento basura inaceptable en los reglamentos de este Establecimiento, el Cliente se compromete asumir todos los costos y obligaciones con el retiro y/o la resolución de cualquier dano(s) causado por la entrega de tal basura inaceptable.

NON-HAZARDOUS WASTE MANIFEST

1. Generator ID Number
NVD008290330

2. Page 1 of 1

3. Emergency Response Phone
(702) 353-4355

4. Waste Tracking Number
Manifest # RZE

40648

5. Generator's Name and Mailing Address

Tronox
P.O. Box 55
Henderson, Nevada 89009 (702) 592-7727

Generator's Site Address (if different than mailing address)

Tronox LLC
560 West Lake Mead Parkway
Henderson, Nevada 89015

Generator's Phone:

6. Transporter 1 Company Name
Las Vegas Paving Corporation NDOT #0191949

U.S. EPA ID Number
NVD986768174

7. Transporter 2 Company Name

U.S. EPA ID Number

8. Designated Facility Name and Site Address

Republic Services of Nevada
Apex, Regional Landfill (702) 423-2128

Profile Number 3825 11 0022

U.S. EPA ID Number

Facility's Phone:

9. Waste Shipping Name and Description

10. Containers

No. Type

11. Total Quantity

12. Unit Wt./Vol.

1. **Regulated Asbestos Containing Material**
mixed with soil and construction debris

Trk 14yards

T 21.68

13. Special Handling Instructions and Additional Information

Asbestos will be wetted down and loads shall be wrapped in 6-mil visqueen. Avoid opening wrapped loads. Breathing Asbestos is hazardous to your health.

Call (702) 353-4355, David Breaud and return to Generator if undeliverable.

CCHD Permit #ATP11-010802 Expires 4/7/2011 DAQEM Project #100633

14. GENERATOR'S/OFFEROR'S CERTIFICATION: I hereby declare that the contents of this consignment are fully and accurately described above by the proper shipping name, and are classified, packaged, marked and labeled/placarded, and are in all respects in proper condition for transport according to applicable international and national governmental regulations.

Generator's/Offoror's Printed/Typed Name

Susan Crowley

Signature

Susan Crowley

Month Day Year

15. International Shipments Import to U.S. Export from U.S.

Port of entry/exit:

Date leaving U.S.:

16. Transporter Acknowledgment of Receipt of Materials

Transporter 1 Printed/Typed Name

Signature

Month Day Year

Transporter 2 Printed/Typed Name

Signature

Month Day Year

17. Discrepancy

17a. Discrepancy Indication Space

Quantity

Type

Residue

Partial Rejection

Full Rejection

Manifest Reference Number:

U.S. EPA ID Number

17b. Alternate Facility (or Generator)

Facility's Phone:

17c. Signature of Alternate Facility (or Generator)

Month Day Year

LVPC Job Number 966525

18. Designated Facility Owner or Operator: Certification of receipt of materials covered by the manifest except as noted in Item 17a

Printed/Typed Name

Signature

Month Day Year

VERA PHILLIPS

Vera Phillips

2 4 11

81 Environmental Tech
13550 N Highway 93
Las Vegas, NV 89165

Ticket Type: INBOUND INVOICE

Ticket Number: 22845
Date: 02/04/2011
Time In: 9:22 pm
Time Out: 9:39 pm

Customer: 001011 - NGE, LLC c/o Northgate Environ Mgmt

Vehicle/Container: 192391
Contract: RZE ASBESTO SOIL 3825 11 0022
Comment: 3825-11-0022

Gross Weight: 80,420 LB Manual In
Tare Weight: 39,260 LB Scale Out
Net Weight: 41160 LB
Net Tons: 20.58

BOL: RZE0647

Origin	Yards	Material	Billing Quantity
Not Applicable	0.00 YD	ASBESTOS FRIABLE	20.58 TN

Driver: _____

Weighmaster: _____

SMITHJ

Indemnification. Customer agrees, by signature above, to indemnify, hold harmless, and defend Republic Services, Inc., its subsidiaries, affiliates, employees, officers and directors from and against any and all liabilities, claims, penalties, forfeitures, suits and the costs and expenses incident thereto, including costs of defense, settlement, and reasonable attorney's fees, which may be incurred, as a result of death or injuries to any person, or damage to any property, contamination of or adverse effects on the environment, caused in whole or in part by the Customer, its employees, or subcontractors in disposing waste at this Facility. In the event Customer delivers Unacceptable Waste (as determined by Republic) Customer agrees to assume all expenses and obligations with the removal and/or resolution of any effects caused by the delivery of such Unacceptable Waste.

Indemnización. Cliente acuerda indemnizar, mantener inmune, y defender Republic Services, Inc., sus subsidiarios, compañías, divisiones, empleados, oficiales y directores contra de cualquiera y de todas responsabilidades, demandas, penas, pérdidas, juicios, pleitos y los costos incidente además, incluyendo costos de defensa, de acuerdo judicial, y de honorarios razonables del abogado, que pueden ser incurridos en, o como resultado de, la muerte o herida personal a cualquier persona, o daños a cualquier característica, propiedad, contaminación de la tierra o efectos ilícitos en esta Facilidad, causado entero o en parte por el cliente, sus empleados, o sus subcontratistas en botar basura en esta Facilidad. En el caso que el Cliente entrega, bota, basura (según lo determinado por Republic) en este Establecimiento basura inaceptable en los reglamentos de este Establecimiento, el Cliente se compromete asumir todos los costos y obligaciones con el retiro y/o la resolución de cualquier dano(s) causado por la entrega de tal basura inaceptable.

NON-HAZARDOUS WASTE MANIFEST		1. Generator ID Number NVD980706330	2. Page 1 of 1	3. Emergency Response Phone (702) 353-4355	4. Waste Tracking Number Manifest # RZE 4647
5. Generator's Name and Mailing Address TRONAK P.O. Box 55 Henderson, Nevada 89009 (702) 592-7727			Generator's Site Address (if different than mailing address) TRONAK LLC 560 West Lake Mead Parkway Henderson, Nevada 89015		
6. Transporter 1 Company Name Las Vegas Paving Corporation NDOT #0191949			U.S. EPA ID Number NVD98078174		
7. Transporter 2 Company Name			U.S. EPA ID Number		
8. Designated Facility Name and Site Address Republic Services of Nevada Apex, Regional Landfill (702) 423-2128			U.S. EPA ID Number Profile Number 3825 11 0022		
9. Waste Shipping Name and Description			10. Containers	11. Total Quantity	12. Unit Wt./Vol.
			No.	Type	
1. Regulated Asbestos Containing Material Mixed with soil and construction debris				Trk	14yards
2.					2x 58 TU
3.					
4.					
13. Special Handling Instructions and Additional Information Asbestos will be wetted down and loads shall be wrapped in 6-mill visqueen. Avoid opening wrapped loads. Breathing Asbestos is hazardous to your health. Call (702) 353-4355, David Bresuit and return to Generator if undeliverable. CCHD Permit #ATP11-010802 Expires 4/7/2011 DAQEM Project #100633					
14. GENERATOR'S/OFFEROR'S CERTIFICATION: I hereby declare that the contents of this consignment are fully and accurately described above by the proper shipping name, and are classified, packaged, marked and labeled/placarded, and are in all respects in proper condition for transport according to applicable international and national governmental regulations.					
Generator's/Offoror's Printed/Typed Name Susan Crowley				Signature <i>Susan Crowley</i>	Month Day Year
15. International Shipments <input type="checkbox"/> Import to U.S. <input type="checkbox"/> Export from U.S. Port of entry/exit: Date leaving U.S.:					
16. Transporter Acknowledgment of Receipt of Materials					
Transporter 1 Printed/Typed Name				Signature	Month Day Year
Transporter 2 Printed/Typed Name				Signature	Month Day Year
17. Discrepancy					
17a. Discrepancy Indication Space <input type="checkbox"/> Quantity <input type="checkbox"/> Type <input type="checkbox"/> Residue <input type="checkbox"/> Partial Rejection <input type="checkbox"/> Full Rejection					
17b. Alternate Facility (or Generator) U.S. EPA ID Number					
17c. Signature of Alternate Facility (or Generator) Month Day Year					
LVPC Job Number 966525					
18. Designated Facility Owner or Operator: Certification of receipt of materials covered by the manifest except as noted in Item 17a					
Printed/Typed Name <i>Jessie Smith</i>				Signature <i>Jessie Smith</i>	Month Day Year 2 4 11

GENERATOR
 INT'L
 TRANSPORTER
 DESIGNATED FACILITY

81 Environmental Tech
13550 N Highway 93
Las Vegas, NV 89165

Ticket Type: INBOUND INVOICE

Ticket Number: 22846
Date: 02/04/2011
Time In: 9:25 pm
Time Out: 9:41 pm

Customer: 001011 - NGE, LLC c/o Northgate Environ Mgmt

Vehicle/Container: 192312
Contract: RZE ASBESTO SOIL 3825 11 0022
Comment: 3825 11 0022

Gross Weight: 79,360 LB Scale In
Tare Weight: 38,260 LB Scale Out
Net Weight: 41100 LB
Net Tons: 20.55

BOL: RZE 0649

Origin	Yards	Material	Billing	Quantity
Not Applicable	0.00 YD	ASBESTOS FRIABLE	20.55	TN

Driver: _____

Weighmaster: _____

IN - phillve OUT - SMITHJ

Indemnification. Customer agrees, by signature above, to indemnify, hold harmless, and defend Republic Services, Inc., its subsidiaries, affiliates, employees, officers and directors from and against any and all liabilities, claims, penalties, forfeitures, suits and the costs and expenses incident thereto, including costs of defense, settlement, and reasonable attorney's fees, which may be incurred, as a result of death or injuries to any person, or damage to any property, contamination of or adverse effects on the environment, caused in whole or in part by the Customer, its employees, or subcontractors in disposing waste at this Facility. In the event Customer delivers Unacceptable Waste (as determined by Republic) Customer agrees to assume all expenses and obligations with the removal and/or resolution of any effects caused by the delivery of such Unacceptable Waste.

Indemnización. Cliente acuerda indemnizar, mantener inmune, y defender Republic Services, Inc., sus subsidiarios, compañías, divisiones, empleados, oficiales y directores contra de cualquiera y de todas responsabilidades, demandas, penas, pérdidas, juicios, pleitos y los costos incidente además, incluyendo costos de defensa, de acuerdo judicial, y de honorarios razonables del abogado, que pueden ser incurridos en, o como resultado de, la muerte o herida personal a cualquier persona, o daños a cualquier característica, propiedad, contaminación de la tierra o efectos ilícitos en esta Facilidad, causado entero o en parte por el cliente, sus empleados, o sus subcontratistas en botar basura en esta Facilidad. En el caso que el Cliente entrega, bota, basura (según lo determinado por Republic) en este Establecimiento basura inaceptable en los reglamentos de este Establecimiento, el Cliente se compromete asumir todos los costos y obligaciones con el retiro y/o la resolución de cualquier dano(s) causado por la entrega de tal basura inaceptable.

NON-HAZARDOUS WASTE MANIFEST

1. Generator ID Number
NVD008290330

2. Page 1 of 1

3. Emergency Response Phone
(702) 353-4355

4. Waste Tracking Number
Manifest # RZE 40849

5. Generator's Name and Mailing Address
Ironox
P.O. Box 55
Henderson, Nevada 89009 (702) 592-7727

Generator's Site Address (if different than mailing address)
Ironox LLC
560 West Lake Mead Parkway
Henderson, Nevada 89015

Generator's Phone:

6. Transporter 1 Company Name
Las Vegas Paving Corporation NDOT #0191949

U.S. EPA ID Number
NVD986788174

7. Transporter 2 Company Name

U.S. EPA ID Number

8. Designated Facility Name and Site Address

U.S. EPA ID Number

Republic Services of Nevada
Apex, Regional Landfill (702) 423-2128

Profile Number 3825 11 0022

Facility's Phone:

9. Waste Shipping Name and Description	10. Containers		11. Total Quantity	12. Unit Wt./Vol.
	No.	Type		
1. Regulated Asbestos Containing Material Mixed with soil and construction debris		Trk	14yards	
2.			10.55	TU
3.				
4.				

13. Special Handling Instructions and Additional Information

Asbestos will be watted down and loads shall be wrapped in 6-mill visqueen. Avoid opening wrapped loads. Breathing Asbestos is hazardous to your health.

Call (702) 353-4355, David Breault and return to Generator if undeliverable.

CCHD Permit #ATP11-010802 Expires 4/7/2011 DAQEM Project #100633

14. GENERATOR'S/OFFEROR'S CERTIFICATION: I hereby declare that the contents of this consignment are fully and accurately described above by the proper shipping name, and are classified, packaged, marked and labeled/placarded, and are in all respects in proper condition for transport according to applicable international and national governmental regulations.

Generator's/Offoror's Printed/Typed Name
Susan Crowley

Signature

Susan Crowley

Month Day Year

15. International Shipments Import to U.S. Export from U.S.

Port of entry/exit:

Date leaving U.S.:

Transporter Signature (for exports only):

16. Transporter Acknowledgment of Receipt of Materials

Transporter 1 Printed/Typed Name

Signature

Month Day Year

Transporter 2 Printed/Typed Name

Signature

Month Day Year

17. Discrepancy

17a. Discrepancy Indication Space

Quantity

Type

Residue

Partial Rejection

Full Rejection

Manifest Reference Number:

17b. Alternate Facility (or Generator)

U.S. EPA ID Number

Facility's Phone:

17c. Signature of Alternate Facility (or Generator)

Month Day Year

LVPC Job Number 966525

18. Designated Facility Owner or Operator: Certification of receipt of materials covered by the manifest except as noted in Item 17a

Printed/Typed Name

Signature

JG Smith

Month Day Year

2 4 11

81 Environmental Tech
13550 N Highway 93
Las Vegas, NV 89165

Ticket Type: INBOUND INVOICE

Ticket Number: 22847
Date: 02/04/2011
Time In: 9:27 pm
Time Out: 9:45 pm

Customer: 001011 - NGE, LLC c/o Northgate Environ Mgmt

Vehicle/Container: 192308
Contract: RZE ASBESTO SOIL 3825 11 0022
Comment: 3825-11-0022

Gross Weight: 81,980 LB Scale In
Tare Weight: 39,920 LB Scale Out
Net Weight: 42060 LB
Net Tons: 21.03

BOL: RZE0650

Origin	Yards	Material	Billing Quantity
Not Applicable	0.00 YD	ASBESTOS FRIABLE	21.03 TN

Driver:

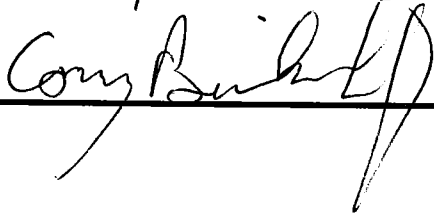
966525

Weighmaster:

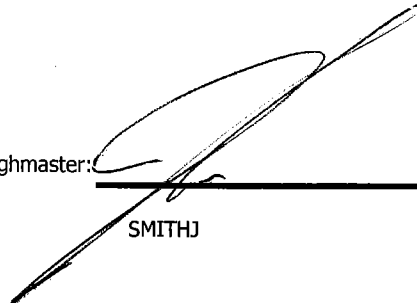
SMITHJ

Indemnification. Customer agrees, by signature above, to indemnify, hold harmless, and defend Republic Services, Inc., its subsidiaries, affiliates, employees, officers and directors from and against any and all liabilities, claims, penalties, forfeitures, suits and the costs and expenses incident thereto, including costs of defense, settlement, and reasonable attorney's fees, which may be incurred, as a result of death or injuries to any person, or damage to any property, contamination of or adverse effects on the environment, caused in whole or in part by the Customer, its employees, or subcontractors in disposing waste at this Facility. In the event Customer delivers Unacceptable Waste (as determined by Republic) Customer agrees to assume all expenses and obligations with the removal and/or resolution of any effects caused by the delivery of such Unacceptable Waste.

Indemnización. Cliente acuerda indemnizar, mantener inmune, y defender Republic Services, Inc., sus subsidiarios, compañías, divisiones, empleados, oficiales y directores contra de cualquiera y de todas responsabilidades, demandas, penas, pérdidas, juicios, pleitos y los costos incidente además, incluyendo costos de defensa, de acuerdo judicial, y de honorarios razonables del abogado, que pueden ser incurridos en, o como resultado de, la muerte o herida personal a cualquier persona, o daños a cualquier característica, propiedad, contaminación de la tierra o efectos ilícitos en esta Facilidat, causado entero o en parte por el cliente, sus empleados, o sus subcontratistas en botar basura en esta Facilidat. En el caso que el Cliente entrega, bota, basura (según lo determinado por Republic) en este Establecimiento basura inaceptable en los reglamentos de este Establecimiento, el Cliente se compromete asumir todos los costos y obligaciones con el retiro y/o la resolución de cualquier dano(s) causado por la entrega de tal basura inaceptable.

NON-HAZARDOUS
WASTE MANIFEST

1. Generator ID Number
NVD008290330

2. Page 1 of
1

3. Emergency Response Phone
(702) 353-4355

4. Waste Tracking Number
Manifest # RZE

450

5. Generator's Name and Mailing Address

Tronox
P.O. Box 55
Henderson, Nevada 89009 (702) 592-7727

Generator's Site Address (if different than mailing address)

Tronox LLC
560 West Lake Mead Parkway
Henderson, Nevada 89015

Generator's Phone:

6. Transporter 1 Company Name

Las Vegas Paving Corporation NDOT #0191949

U.S. EPA ID Number

NVD986768174

7. Transporter 2 Company Name

U.S. EPA ID Number

8. Designated Facility Name and Site Address

Republic Services of Nevada
Apex, Regional Landfill (702) 423-2128

U.S. EPA ID Number

Profile Number 3825 11 0022

Facility's Phone:

9. Waste Shipping Name and Description

10. Containers

11. Total Quantity

12. Unit Wt./Vol.

No.

Type

1.

Regulated Asbestos Containing Material
Mixed with soil and construction debris

Trk

14 yards

2.

21-03 TH

3.

4.

13. Special Handling Instructions and Additional Information

Asbestos will be wetted down and loads shall be wrapped in 6-mil visqueen. Avoid opening wrapped loads. Breathing Asbestos is hazardous to your health.

Call (702) 353-4355, David Bresult and return to Generator if undeliverable.

CCHD Permit #ATP11-010802 Expires 4/7/2011

DAQEM Project #100633

14. GENERATOR'S/OFFEROR'S CERTIFICATION: I hereby declare that the contents of this consignment are fully and accurately described above by the proper shipping name, and are classified, packaged, marked and labeled/placarded, and are in all respects in proper condition for transport according to applicable international and national governmental regulations.

Generator's/Offeror's Printed/Typed Name

Susan Crowley

Signature

Susan Crowley

Month Day Year

15. International Shipments Import to U.S. Export from U.S.

Transporter Signature (for exports only):

Port of entry/exit:

Date leaving U.S.:

16. Transporter Acknowledgment of Receipt of Materials

Transporter 1 Printed/Typed Name

Transporter 2 Printed/Typed Name

Signature

Cathy Brinkerhoff

Signature

Cathy Brinkerhoff

Month Day Year

Month Day Year

2 4 11

17. Discrepancy

17a. Discrepancy Indication Space

Quantity

Type

Residue

Partial Rejection

Full Rejection

17b. Alternate Facility (or Generator)

Manifest Reference Number:

U.S. EPA ID Number

Facility's Phone:

17c. Signature of Alternate Facility (or Generator)

Month Day Year

LVPC Job Number 966525

18. Designated Facility Owner or Operator. Certification of receipt of materials covered by the manifest except as noted in Item 17a

Printed/Typed Name

Signature

Jessie Smith

Month Day Year

2 8 11

81 Environmental Tech
13550 N Highway 93
Las Vegas, NV 89165

Ticket Type: INBOUND INVOICE

Ticket Number: 22848
Date: 02/04/2011
Time In: 9:35 pm
Time Out: 9:51 pm

Customer: 001011 - NGE, LLC c/o Northgate Environ Mgmt

Vehicle/Container: 192334
Contract: RZE ASBESTO SOIL 3825 11 0022
Comment: 3825-11-0022

Gross Weight: 80,140 LB Manual In
Tare Weight: 37,340 LB Scale Out
Net Weight: 42800 LB
Net Tons: 21.40

BOL: RZE0652

Origin	Yards	Material	Billing	Quantity
Not Applicable	0.00 YD	ASBESTOS FRIABLE	21.40	TN

Driver: _____

Weighmaster: _____

SMITHJ

Indemnification. Customer agrees, by signature above, to indemnify, hold harmless, and defend Republic Services, Inc., its subsidiaries, affiliates, employees, officers and directors from and against any and all liabilities, claims, penalties, forfeitures, suits and the costs and expenses incident thereto, including costs of defense, settlement, and reasonable attorney's fees, which may be incurred, as a result of death or injuries to any person, or damage to any property, contamination of or adverse effects on the environment, caused in whole or in part by the Customer, its employees, or subcontractors in disposing waste at this Facility. In the event Customer delivers Unacceptable Waste (as determined by Republic) Customer agrees to assume all expenses and obligations with the removal and/or resolution of any effects caused by the delivery of such Unacceptable Waste.

Indemnización. Cliente acuerda indemnizar, mantener inmune, y defender Republic Services, Inc., sus subsidiarios, compañías, divisiones, empleados, oficiales y directores contra de cualquiera y de todas responsabilidades, demandas, penas, pérdidas, juicios, pleitos y los costos incidente además, incluyendo costos de defensa, de acuerdo judicial, y de honorarios razonables del abogado, que pueden ser incurridos en, o como resultado de, la muerte o herida personal a cualquier persona, o daños a cualquier característica, propiedad, contaminación de la tierra o efectos ilícitos en esta Facilidad, causado entero o en parte por el cliente, sus empleados, o sus subcontratistas en botar basura en esta Facilidad. En el caso que el Cliente entrega, bota, basura (según lo determinado por Republic) en este Establecimiento basura inaceptable en los reglamentos de este Establecimiento, el Cliente se compromete asumir todos los costos y obligaciones con el retiro y/o la resolución de cualquier dano(s) causado por la entrega de tal basura inaceptable.

NON-HAZARDOUS WASTE MANIFEST

1. Generator ID Number
NVD008290330

2. Page 1 of
1

3. Emergency Response Phone
(702) 353-4355

4. Waste Tracking Number
Manifest # **RZE 420652**

5. Generator's Name and Mailing Address
**Tronox
P.O. Box 55
Henderson, Nevada 89009 (702) 592-7727**

Generator's Site Address (if different than mailing address)
**Tronox LLC
560 West Lake Mead Parkway
Henderson, Nevada 89015**

6. Transporter 1 Company Name
Las Vegas Paving Corporation NDOT #0191949

U.S. EPA ID Number
NVD986768174

7. Transporter 2 Company Name

U.S. EPA ID Number

8. Designated Facility Name and Site Address
**Republic Services of Nevada
Apex, Regional Landfill (702) 423-2128**

U.S. EPA ID Number
Profile Number 3825 11 0022

Facility's Phone:

9. Waste Shipping Name and Description	10. Containers		11. Total Quantity	12. Unit Wt./Vol.
	No.	Type		
1. Regulated Asbestos Containing Material mixed with soil and construction debris		Trk	14yards	
2.			21.40	TR
3.				
4.				

13. Special Handling Instructions and Additional Information
**Asbestos will be wetted down and loads shall be wrapped in 6-mil visqueen. Avoid opening wrapped loads. Breathing Asbestos is hazardous to your health.
Call (702) 353-4355, David Breaux and return to Generator if undeliverable.
CCHD Permit #ATP11-010802 Expires 4/7/2011 DAQEM Project #100633**

14. GENERATOR'S/OFFEROR'S CERTIFICATION: I hereby declare that the contents of this consignment are fully and accurately described above by the proper shipping name, and are classified, packaged, marked and labeled/placarded, and are in all respects in proper condition for transport according to applicable international and national governmental regulations.

Generator's/Offorer's Printed/Typed Name: **Susan Crowley** Signature: *[Signature]* Month: Day: Year:

15. International Shipments Import to U.S. Export from U.S. Port of entry/exit: Date leaving U.S.:

16. Transporter Acknowledgment of Receipt of Materials
Transporter 1 Printed/Typed Name: *[Signature]* Signature: *[Signature]* Month: Day: Year: **2 4 11**
Transporter 2 Printed/Typed Name: Signature: Month: Day: Year:

17. Discrepancy
17a. Discrepancy Indication Space Quantity Type Residue Partial Rejection Full Rejection

17b. Alternate Facility (or Generator) Manifest Reference Number: U.S. EPA ID Number:

Facility's Phone:

17c. Signature of Alternate Facility (or Generator) Month: Day: Year:

LVPC Job Number 966525

18. Designated Facility Owner or Operator: Certification of receipt of materials covered by the manifest except as noted in Item 17a
Printed/Typed Name: **Jason Smith** Signature: *[Signature]* Month: Day: Year: **2 3 11**

81 Environmental Tech
13550 N Highway 93
Las Vegas, NV 89165

Ticket Type: INBOUND INVOICE

Ticket Number: 22849
Date: 02/04/2011
Time In: 9:33 pm
Time Out: 9:56 pm

Customer: 001011 - NGE, LLC c/o Northgate Environ Mgmt

Vehicle/Container: 192307
Contract: RZE ASBESTO SOIL 3825 11 0022
Comment: 3825 11 0022

Gross Weight: 82,380 LB Scale In
Tare Weight: 39,940 LB Scale Out
Net Weight: 42440 LB
Net Tons: 21.22

BOL: RZE 0651

Origin	Yards	Material	Billing	Quantity
Not Applicable	0.00 YD	ASBESTOS FRIABLE	21.22	TN

Driver: _____

M. J. J. J.

16627

Weighmaster: _____

[Signature]

phillve

Indemnification. Customer agrees, by signature above, to indemnify, hold harmless, and defend Republic Services, Inc., its subsidiaries, affiliates, employees, officers and directors from and against any and all liabilities, claims, penalties, forfeitures, suits and the costs and expenses incident thereto, including costs of defense, settlement, and reasonable attorney's fees, which may be incurred, as a result of death or injuries to any person, or damage to any property, contamination of or adverse effects on the environment, caused in whole or in part by the Customer, its employees, or subcontractors in disposing waste at this Facility. In the event Customer delivers Unacceptable Waste (as determined by Republic) Customer agrees to assume all expenses and obligations with the removal and/or resolution of any effects caused by the delivery of such Unacceptable Waste.

Indemnización. Cliente acuerda indemnizar, mantener inmune, y defender Republic Services, Inc., sus subsidiarios, compañías, divisiones, empleados, oficiales y directores contra de cualquiera y de todas responsabilidades, demandas, penas, pérdidas, juicios, pleitos y los costos incidente además, incluyendo costos de defensa, de acuerdo judicial, y de honorarios razonables del abogado, que pueden ser incurridos en, o como resultado de, la muerte o herida personal a cualquier persona, o daños a cualquier característica, propiedad, contaminación de la tierra o efectos ilícitos en esta Facilidad, causado entero o en parte por el cliente, sus empleados, o sus subcontratistas en botar basura en esta Facilidad. En el caso que el Cliente entrega, bota, basura (según lo determinado por Republic) en este Establecimiento basura inaceptable en los reglamentos de este Establecimiento, el Cliente se compromete asumir todos los costos y obligaciones con el retiro y/o la resolución de cualquier dano(s) causado por la entrega de tal basura inaceptable.

NON-HAZARDOUS WASTE MANIFEST 1. Generator ID Number: **NVD008290330** 2. Page 1 of 1 3. Emergency Response Phone: **(702) 353-4355** 4. Waste Tracking Number: **Manifest # RZE #1651**

5. Generator's Name and Mailing Address: **Tronox P.O. Box 55 Henderson, Nevada 89009 (702) 592-7727** Generator's Site Address (if different than mailing address): **Tronox LLC 560 West Lake Mead Parkway Henderson, Nevada 89015**

6. Transporter 1 Company Name: **Las Vegas Paving Corporation** NDCCT #0191949 U.S. EPA ID Number: **NVD988768174**

7. Transporter 2 Company Name: U.S. EPA ID Number:

8. Designated Facility Name and Site Address: **Republic Services of Nevada Apex, Regional Landfill (702) 423-2128** Profile Number: **3825 11 0022** U.S. EPA ID Number:

9. Waste Shipping Name and Description	10. Containers		11. Total Quantity	12. Unit Wt./Vol.
	No.	Type		
1. Regulated Asbestos Containing Material Mixed with soil and construction debris		Trk	14yards	
2.				T 2122
3.				
4.				

13. Special Handling Instructions and Additional Information: **Asbestos will be wetted down and loads shall be wrapped in 6-mil visqueen. Avoid opening wrapped loads. Breathing Asbestos is hazardous to your health. Call (702) 353-4355, David Breault and return to Generator if undeliverable. CCHD Permit #ATP11-010802 Expires 4/7/2011 DAQEM Project #100633**

14. GENERATOR'S/OFFEROR'S CERTIFICATION: I hereby declare that the contents of this consignment are fully and accurately described above by the proper shipping name, and are classified, packaged, marked and labeled/placarded, and are in all respects in proper condition for transport according to applicable international and national governmental regulations.

Generator's/Offoror's Printed/Typed Name: **Susan Crowley** Signature: *Susan Crowley* Month: Day: Year:

15. International Shipments Import to U.S. Export from U.S. Port of entry/exit: Date leaving U.S.:

16. Transporter Acknowledgment of Receipt of Materials

Transporter 1 Printed/Typed Name: **Mary M. Dixon** Signature: *Mary M. Dixon* Month: **2** Day: **9** Year: **11**

Transporter 2 Printed/Typed Name: Signature: Month: Day: Year:

17. Discrepancy

17a. Discrepancy Indication Space Quantity Type Residue Partial Rejection Full Rejection

Manifest Reference Number:

17b. Alternate Facility (or Generator) U.S. EPA ID Number:

Facility's Phone:

17c. Signature of Alternate Facility (or Generator) Month: Day: Year:

LVPC Job Number 966525

18. Designated Facility Owner or Operator: Certification of receipt of materials covered by the manifest except as noted in Item 17a

Printed/Typed Name: **VERA PHILLIPS** Signature: *Vera Phillips* Month: **2** Day: **9** Year: **11**

81 Environmental Tech
13550 N Highway 93
Las Vegas, NV 89165

Ticket Type: INBOUND INVOICE

Ticket Number: 22850
Date: 02/04/2011
Time In: 9:41 pm
Time Out: 9:59 pm

Customer: 001011 - NGE, LLC c/o Northgate Environ Mgmt

Vehicle/Container: 192393
Contract: RZE ASBESTO SOIL 3825 11 0022
Comment: 3825 11 0022

Gross Weight: 85,260 LB Scale In
Tare Weight: 41,800 LB Scale Out
Net Weight: 43460 LB
Net Tons: 21.73

BOL: RZE 0653

Origin	Yards	Material	Billing	Quantity
Not Applicable	0.00 YD	ASBESTOS FRIABLE	21.73	TN

Driver:



Weighmaster:

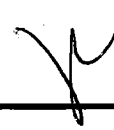

phillve

Indemnification. Customer agrees, by signature above, to indemnify, hold harmless, and defend Republic Services, Inc., its subsidiaries, affiliates, employees, officers and directors from and against any and all liabilities, claims, penalties, forfeitures, suits and the costs and expenses incident thereto, including costs of defense, settlement, and reasonable attorney's fees, which may be incurred, as a result of death or injuries to any person, or damage to any property, contamination of or adverse effects on the environment, caused in whole or in part by the Customer, its employees, or subcontractors in disposing waste at this Facility. In the event Customer delivers Unacceptable Waste (as determined by Republic) Customer agrees to assume all expenses and obligations with the removal and/or resolution of any effects caused by the delivery of such Unacceptable Waste.

Indemnización. Cliente acuerda indemnizar, mantener inmune, y defender Republic Services, Inc., sus subsidiarios, companias, divisiones, empleados, oficiales y directores contra de cualquiera y de todas responsabilidades, demandas, penas, pérdidas, juicios, pleitos y los costos incidente además, incluyendo costos de defensa, de acuerdo judicial, y de honorarios razonables del abogado, que pueden ser incurridos en, o como resultado de, la muerte o herida personal a cualquier persona, o daños a cualquier característica, propiedad, contaminación de la tierra o efectos ilicitos en esta Facilidad, causado entero o en parte por el cliente, sus empleados, o sus subcontratistas en botar basura en esta Facilidad. En el caso que el Cliente entrega, bota, basura (según lo determinado por Republic) en este Establecimiento basura inaceptable en los reglamentos de este Establecimiento, el Cliente se compromete asumir todos los costos y obligaciones con el retiro y/o la resolución de cualquier dano(s) causado por la entrega de tal basura inaceptable.

NON-HAZARDOUS WASTE MANIFEST

1. Generator ID Number
NV1000006330

2. Page 1 of 1
3. Emergency Response Phone
(702) 353-4355

4. Waste Tracking Number
Manifest # **RZE**

9053

5. Generator's Name and Mailing Address

Ironox
P.O. Box 53
Henderson, Nevada 89009 (702) 592-7727

Generator's Site Address (if different than mailing address)

Ironox LLC
560 West Lake Mead Parkway
Henderson, Nevada 89015

Generator's Phone:

6. Transporter 1 Company Name
Las Vegas Paving Corporation NDOT #0191949

U.S. EPA ID Number
NV10000063174

7. Transporter 2 Company Name

U.S. EPA ID Number

8. Designated Facility Name and Site Address

Republic Services of Nevada
Apex, Regional Landfill (702) 423-2128

U.S. EPA ID Number

Profile Number 3825 11 0022

Facility's Phone:

9. Waste Shipping Name and Description

10. Containers

No. Type

11. Total Quantity

12. Unit Wt./Vol.

1. **Regulated Asbestos Containing Material**
Mixed with soil and construction debris

Trk 14 yards

T 21.73

13. Special Handling Instructions and Additional Information

Asbestos will be wetted down and loads shall be wrapped in 6-mil visqueen. Avoid opening wrapped loads. Breathing Asbestos is hazardous to your health.

Call (702) 353-4355, David Breaux and return to Generator if undeliverable.

CCHD Permit #ATP11-010802 Expires 4/7/2011 DAQEM Project #100633

14. GENERATOR'S/OFFEROR'S CERTIFICATION: I hereby declare that the contents of this consignment are fully and accurately described above by the proper shipping name, and are classified, packaged, marked and labeled/placarded, and are in all respects in proper condition for transport according to applicable international and national governmental regulations.

Generator's/Offeor's Printed/Typed Name

Susan Crowley

Signature

Susan Crowley

Month Day Year

15. International Shipments Import to U.S. Export from U.S.

Port of entry/exit:

Date leaving U.S.:

16. Transporter Acknowledgment of Receipt of Materials

Transporter 1 Printed/Typed Name

Michael P. ...

Signature

Michael P. ...

Month Day Year

2 4 11

Transporter 2 Printed/Typed Name

Signature

17. Discrepancy

17a. Discrepancy Indication Space

Quantity

Type

Residue

Partial Rejection

Full Rejection

Manifest Reference Number:

U.S. EPA ID Number

17b. Alternate Facility (or Generator)

Facility's Phone:

17c. Signature of Alternate Facility (or Generator)

Month Day Year

LVPC Job Number 966525

18. Designated Facility Owner or Operator: Certification of receipt of materials covered by the manifest except as noted in Item 17a

Printed/Typed Name

VERA PHILLIPS

Signature

Vera Phillips

Month Day Year

2 4 11

81 Environmental Tech
13550 N Highway 93
Las Vegas, NV 89165

Ticket Type: INBOUND INVOICE

Ticket Number: 22851
Date: 02/04/2011
Time In: 9:44 pm
Time Out: 10:03 pm

Customer: 001011 - NGE, LLC c/o Northgate Environ Mgmt

Vehicle/Container: 192330
Contract: RZE ASBESTO SOIL 3825 11 0022
Comment: 3825 11 0022

Gross Weight: 78,100 LB Manual In
Tare Weight: 36,180 LB Scale Out
Net Weight: 41920 LB
Net Tons: 20.96

BOL: RZE 0654

Origin	Yards	Material	Billing	Quantity
Not Applicable	0.00 YD	ASBESTOS FRIABLE	20.96	TN

Driver:



Weighmaster:

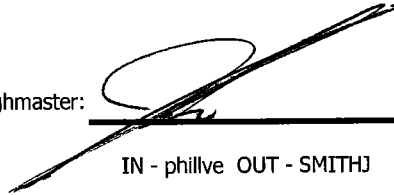

IN - phillve OUT - SMITHJ

Indemnification. Customer agrees, by signature above, to indemnify, hold harmless, and defend Republic Services, Inc., its subsidiaries, affiliates, employees, officers and directors from and against any and all liabilities, claims, penalties, forfeitures, suits and the costs and expenses incident thereto, including costs of defense, settlement, and reasonable attorney's fees, which may be incurred, as a result of death or injuries to any person, or damage to any property, contamination of or adverse effects on the environment, caused in whole or in part by the Customer, its employees, or subcontractors in disposing waste at this Facility. In the event Customer delivers Unacceptable Waste (as determined by Republic) Customer agrees to assume all expenses and obligations with the removal and/or resolution of any effects caused by the delivery of such Unacceptable Waste.

Indemnización. Cliente acuerda indemnizar, mantener inmune, y defender Republic Services, Inc., sus subsidiarios, compañías, divisiones, empleados, oficiales y directores contra de cualquiera y de todas responsabilidades, demandas, penas, pérdidas, juicios, pleitos y los costos incidente además, incluyendo costos de defensa, de acuerdo judicial, y de honorarios razonables del abogado, que pueden ser incurridos en, o como resultado de, la muerte o herida personal a cualquier persona, o daños a cualquier característica, propiedad, contaminación de la tierra o efectos ilícitos en esta Facilidad, causado entero o en parte por el cliente, sus empleados, o sus subcontratistas en botar basura en esta Facilidad. En el caso que el Cliente entrega, bota, basura (según lo determinado por Republic) en este Establecimiento basura inaceptable en los reglamentos de este Establecimiento, el Cliente se compromete asumir todos los costos y obligaciones con el retiro y/o la resolución de cualquier dano(s) causado por la entrega de tal basura inaceptable.

NON-HAZARDOUS
WASTE MANIFEST

1. Generator ID Number
NVD008290330

2. Page 1 of
1

3. Emergency Response Phone
(702) 353-4355

4. Waste Tracking Number
Manifest # RZE 40854

5. Generator's Name and Mailing Address

Tronox
P.O. Box 55
Henderson, Nevada 89009 (702) 592-7727

Generator's Site Address (if different than mailing address)

Tronox LLC
560 West Lake Mead Parkway
Henderson, Nevada 89015

6. Transporter 1 Company Name

Las Vegas Paving Corporation NDOT #0191949

U.S. EPA ID Number
NVD986768174

7. Transporter 2 Company Name

U.S. EPA ID Number

8. Designated Facility Name and Site Address

Republic Services of Nevada
Apex, Regional Landfill (702) 423-2128

U.S. EPA ID Number

Profile Number 3825 11 0022

Facility's Phone:

9. Waste Shipping Name and Description

10. Containers

No. Type

11. Total
Quantity

12. Unit
Wt./Vol.

1. Regulated Asbestos Containing Material
Mixed with soil and construction debris

Trk 14yards

2. 20.96 TK

3.
4.

13. Special Handling Instructions and Additional Information

Asbestos will be wetted down and loads shall be wrapped in 6-mil visqueen. Avoid opening wrapped loads. Breathing Asbestos is hazardous to your health.
Call (702) 353-4355, David Breault and return to Generator if undeliverable.
CCHD Permit #ATP11-010802 Expires 4/7/2011 DAQEM Project #100633

14. GENERATOR'S/OFFEROR'S CERTIFICATION: I hereby declare that the contents of this consignment are fully and accurately described above by the proper shipping name, and are classified, packaged, marked and labeled/placarded, and are in all respects in proper condition for transport according to applicable international and national governmental regulations.

Generator's/Offeror's Printed/Typed Name

Susan Crowley

Signature

Susan Crowley

Month Day Year

15. International Shipments Import to U.S. Export from U.S.

Port of entry/exit:

Date leaving U.S.:

16. Transporter Acknowledgment of Receipt of Materials

Transporter 1 Printed/Typed Name

Signature

Month Day Year

Transporter 2 Printed/Typed Name

Signature

Month Day Year

17. Discrepancy

17a. Discrepancy Indication Space

Quantity

Type

Residue

Partial Rejection

Full Rejection

Manifest Reference Number:

17b. Alternate Facility (or Generator)

U.S. EPA ID Number

Facility's Phone:

17c. Signature of Alternate Facility (or Generator)

Month Day Year

LVPC Job Number 966525

18. Designated Facility Owner or Operator: Certification of receipt of materials covered by the manifest except as noted in Item 17a

Printed/Typed Name

Jesse Smith

Signature

Jesse Smith

Month Day Year

2 8 11

81 Environmental Tech
13550 N Highway 93
Las Vegas, NV 89165

Ticket Type: INBOUND INVOICE

Ticket Number: 22852
Date: 02/04/2011
Time In: 9:55 pm
Time Out: 10:09 pm

Customer: 001011 - NGE, LLC c/o Northgate Environ Mgmt

Vehicle/Container: 192346
Contract: RZE ASBESTO SOIL 3825 11 0022
Comment: 3825-11-0022

Gross Weight: 81,640 LB Scale In
Tare Weight: 36,760 LB Scale Out
Net Weight: 44880 LB
Net Tons: 22.44

BOL: RZE0655

Origin	Yards	Material	Billing	Quantity
Not Applicable	0.00 YD	ASBESTOS FRIABLE	22.44	TN

Driver: 

Weighmaster: 

SMITHJ

Indemnification. Customer agrees, by signature above, to indemnify, hold harmless, and defend Republic Services, Inc., its subsidiaries, affiliates, employees, officers and directors from and against any and all liabilities, claims, penalties, forfeitures, suits and the costs and expenses incident thereto, including costs of defense, settlement, and reasonable attorney's fees, which may be incurred, as a result of death or injuries to any person, or damage to any property, contamination of or adverse effects on the environment, caused in whole or in part by the Customer, its employees, or subcontractors in disposing waste at this Facility. In the event Customer delivers Unacceptable Waste (as determined by Republic) Customer agrees to assume all expenses and obligations with the removal and/or resolution of any effects caused by the delivery of such Unacceptable Waste.

Indemnización. Cliente acuerda indemnizar, mantener inmune, y defender Republic Services, Inc., sus subsidiarios, compañías, divisiones, empleados, oficiales y directores contra de cualquiera y de todas responsabilidades, demandas, penas, pérdidas, juicios, pleitos y los costos incidente además, incluyendo costos de defensa, de acuerdo judicial, y de honorarios razonables del abogado, que pueden ser incurridos en, o como resultado de, la muerte o herida personal a cualquier persona, o daños a cualquier característica, propiedad, contaminación de la tierra o efectos ilícitos en esta Facilidad, causado entero o en parte por el cliente, sus empleados, o sus subcontratistas en botar basura en esta Facilidad. En el caso que el Cliente entrega, bota, basura (según lo determinado por Republic) en este Establecimiento basura inaceptable en los reglamentos de este Establecimiento, el Cliente se compromete asumir todos los costos y obligaciones con el retiro y/o la resolución de cualquier dano(s) causado por la entrega de tal basura inaceptable.

NON-HAZARDOUS WASTE MANIFEST

1. Generator ID Number
NVD008290330

2. Page 1 of 1

3. Emergency Response Phone
(702) 353-4355

4. Waste Tracking Number
Manifest # RZE 40655

5. Generator's Name and Mailing Address

Tronox
P.O. Box 55
Henderson, Nevada 89009 (702) 592-7727

Generator's Site Address (if different than mailing address)

Tronox LLC
560 West Lake Mead Parkway
Henderson, Nevada 89015

Generator's Phone:

6. Transporter 1 Company Name

Las Vegas Paving Corporation NDOT #0191949

U.S. EPA ID Number
NVD986782174

7. Transporter 2 Company Name

U.S. EPA ID Number

8. Designated Facility Name and Site Address

Republic Services of Nevada
Apex, Regional Landfill (702) 423-2128

U.S. EPA ID Number

Profile Number 3825 11 0022

Facility's Phone:

9. Waste Shipping Name and Description

Regulated Asbestos Containing Material
Mixed with soil and construction debris

10. Containers

No. Type

11. Total Quantity

12. Unit Wt./Vol.

Trk 14yards

22.44 TON

13. Special Handling Instructions and Additional Information

Asbestos will be wetted down and loads shall be wrapped in 6-mil visqueen. Avoid opening wrapped loads. Breathing Asbestos is hazardous to your health.

Call (702) 353-4355, David Breault and return to Generator if undeliverable.

CCHD Permit #ATP11-010802 Expires 4/7/2011

DAQEM Project #100633

14. GENERATOR'S/OFFEROR'S CERTIFICATION: I hereby declare that the contents of this consignment are fully and accurately described above by the proper shipping name, and are classified, packaged, marked and labeled/placarded, and are in all respects in proper condition for transport according to applicable international and national governmental regulations.

Generator's/Offeror's Printed/Typed Name

Susan Crowley

Signature

Susan Crowley

Month Day Year

15. International Shipments Import to U.S.

Export from U.S.

Port of entry/exit:

Date leaving U.S.:

16. Transporter Acknowledgment of Receipt of Materials

Transporter 1 Printed/Typed Name

Keith Sirevaag

Signature

Keith Sirevaag

Month Day Year

Transporter 2 Printed/Typed Name

Signature

Month Day Year

17. Discrepancy

17a. Discrepancy Indication Space

Quantity

Type

Residue

Partial Rejection

Full Rejection

Manifest Reference Number:

U.S. EPA ID Number

17b. Alternate Facility (or Generator)

Facility's Phone:

17c. Signature of Alternate Facility (or Generator)

Month Day Year

LVPC Job Number 966525

18. Designated Facility Owner or Operator: Certification of receipt of materials covered by the manifest except as noted in Item 17a

Printed/Typed Name

Jesse Smith

Signature

Jesse Smith

Month Day Year

2 8 11

81 Environmental Tech
13550 N Highway 93
Las Vegas, NV 89165

Ticket Type: INBOUND INVOICE

Ticket Number: 22853
Date: 02/04/2011
Time In: 10:53 pm
Time Out: 11:11 pm

Customer: 001011 - NGE, LLC c/o Northgate Environ Mgmt

Vehicle/Container: 192392
Contract: RZE ASBESTO SOIL 3825 11 0022
Comment: 3825-11-0022

Gross Weight: 88,300 LB Scale In
Tare Weight: 42,020 LB Scale Out
Net Weight: 46280 LB
Net Tons: 23.14

BOL: RZE0656

Origin	Yards	Material	Billing	Quantity
Not Applicable	0.00 YD	ASBESTOS FRIABLE	23.14	TN

Driver: _____

Weighmaster: _____

SMITHJ

Indemnification. Customer agrees, by signature above, to indemnify, hold harmless, and defend Republic Services, Inc., its subsidiaries, affiliates, employees, officers and directors from and against any and all liabilities, claims, penalties, forfeitures, suits and the costs and expenses incident thereto, including costs of defense, settlement, and reasonable attorney's fees, which may be incurred, as a result of death or injuries to any person, or damage to any property, contamination of or adverse effects on the environment, caused in whole or in part by the Customer, its employees, or subcontractors in disposing waste at this Facility. In the event Customer delivers Unacceptable Waste (as determined by Republic) Customer agrees to assume all expenses and obligations with the removal and/or resolution of any effects caused by the delivery of such Unacceptable Waste.

Indemnización. Cliente acuerda indemnizar, mantener inmune, y defender Republic Services, Inc., sus subsidiarios, compañías, divisiones, empleados, oficiales y directores contra de cualquiera y de todas responsabilidades, demandas, penas, pérdidas, juicios, pleitos y los costos incidente además, incluyendo costos de defensa, de acuerdo judicial, y de honorarios razonables del abogado, que pueden ser incurridos en, o como resultado de, la muerte o herida personal a cualquier persona, o daños a cualquier característica, propiedad, contaminación de la tierra o efectos ilícitos en esta Facilidad, causado entero o en parte por el cliente, sus empleados, o sus subcontratistas en botar basura en esta Facilidad. En el caso que el Cliente entrega, bota, basura (según lo determinado por Republic) en este Establecimiento basura inaceptable en los reglamentos de este Establecimiento, el Cliente se compromete asumir todos los costos y obligaciones con el retiro y/o la resolución de cualquier dano(s) causado por la entrega de tal basura inaceptable.

NON-HAZARDOUS WASTE MANIFEST

1. Generator ID Number
NVD008290330

2. Page 1 of
1

3. Emergency Response Phone
(702) 353-4355

4. Waste Tracking Number
Manifest # **RZE 9656**

5. Generator's Name and Mailing Address

Tronox
P.O. Box 55
Henderson, Nevada 89009 (702) 592-7727

Generator's Site Address (if different than mailing address)

Tronox LLC
560 West Lake Mead Parkway
Henderson, Nevada 89015

Generator's Phone:

6. Transporter 1 Company Name

Las Vegas Paving Corporation NDOT #0191949

U.S. EPA ID Number

NVD986768174

7. Transporter 2 Company Name

U.S. EPA ID Number

8. Designated Facility Name and Site Address

Republic Services of Nevada
Apex, Regional Landfill (702) 423-2128

Profile Number 3825 11 0022

U.S. EPA ID Number

Facility's Phone:

9. Waste Shipping Name and Description

10. Containers

No. Type

11. Total Quantity

12. Unit Wt./Vol.

1.

Regulated Asbestos Containing Material
Mixed with soil and construction debris

Trk 14yards

2.

23.14 TW

3.

4.

13. Special Handling Instructions and Additional Information

Asbestos will be wetted down and loads shall be wrapped in 6-mill visqueen. Avoid opening wrapped loads. Breathing Asbestos is hazardous to your health.

Call (702) 353-4355, David Breault and return to Generator if undeliverable.

CCHD Permit #ATP11-010802 Expires 4/7/2011 DAQEM Project #100633

14. GENERATOR'S/OFFEROR'S CERTIFICATION: I hereby declare that the contents of this consignment are fully and accurately described above by the proper shipping name, and are classified, packaged, marked and labeled/placarded, and are in all respects in proper condition for transport according to applicable international and national governmental regulations.

Generator's/Offeor's Printed/Typed Name

Susan Crowley

Signature

Susan Crowley

Month Day Year

15. International Shipments Import to U.S. Export from U.S.

Port of entry/exit:

Transporter Signature (for exports only):

Date leaving U.S.:

TRANSPORTER

16. Transporter Acknowledgment of Receipt of Materials

Transporter 1 Printed/Typed Name

Jerry Land

Signature

Jerry Land

Month Day Year

Transporter 2 Printed/Typed Name

Signature

[Signature]

Month Day Year

17. Discrepancy

17a. Discrepancy Indication Space

Quantity

Type

Residue

Partial Rejection

Full Rejection

Manifest Reference Number:

U.S. EPA ID Number

17b. Alternate Facility (or Generator)

Facility's Phone:

17c. Signature of Alternate Facility (or Generator)

Month Day Year

LVPC Job Number 966525

18. Designated Facility Owner or Operator: Certification of receipt of materials covered by the manifest except as noted in Item 17a

Printed/Typed Name

Jason Smith

Signature

[Signature]

Month Day Year

2 8 11

81 Environmental Tech
13550 N Highway 93
Las Vegas, NV 89165

Ticket Type: INBOUND INVOICE

Ticket Number: 22854
Date: 02/04/2011
Time In: 10:59 pm
Time Out: 11:15 pm

Customer: 001011 - NGE, LLC c/o Northgate Environ Mgmt

Vehicle/Container: 192369
Contract: RZE ASBESTO SOIL 3825 11 0022
Comment: 38205-11-0022

Gross Weight: 85,860 LB Scale In
Tare Weight: 41,220 LB Scale Out
Net Weight: 44640 LB
Net Tons: 22.32

BOL: RZE0657

Origin	Yards	Material	Billing	Quantity
Not Applicable	0.00 YD	ASBESTOS FRIABLE	22.32	TN

Driver:

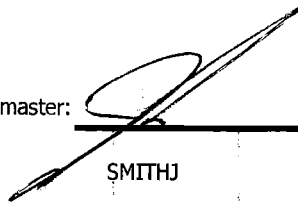

Weighmaster:

SMITHJ

Indemnification. Customer agrees, by signature above, to indemnify, hold harmless, and defend Republic Services, Inc., its subsidiaries, affiliates, employees, officers and directors from and against any and all liabilities, claims, penalties, forfeitures, suits and the costs and expenses incident thereto, including costs of defense, settlement, and reasonable attorney's fees, which may be incurred, as a result of death or injuries to any person, or damage to any property, contamination of or adverse effects on the environment, caused in whole or in part by the Customer, its employees, or subcontractors in disposing waste at this Facility. In the event Customer delivers Unacceptable Waste (as determined by Republic) Customer agrees to assume all expenses and obligations with the removal and/or resolution of any effects caused by the delivery of such Unacceptable Waste.

Indemnización. Cliente acuerda indemnizar, mantener inmune, y defender Republic Services, Inc., sus subsidiarios, compañías, divisiones, empleados, oficiales y directores contra de cualquiera y de todas responsabilidades, demandas, penas, pérdidas, juicios, pleitos y los costos incidente además, incluyendo costos de defensa, de acuerdo judicial, y de honorarios razonables del abogado, que pueden ser incurridos en, o como resultado de, la muerte o herida personal a cualquier persona, o daños a cualquier característica, propiedad, contaminación de la tierra o efectos ilícitos en esta Facilidad, causado entero o en parte por el cliente, sus empleados, o sus subcontratistas en botar basura en esta Facilidad. En el caso que el Cliente entrega, bota, basura (según lo determinado por Republic) en este Establecimiento basura inaceptable en los reglamentos de este Establecimiento, el Cliente se compromete asumir todos los costos y obligaciones con el retiro y/o la resolución de cualquier dano(s) causado por la entrega de tal basura inaceptable.

NON-HAZARDOUS WASTE MANIFEST

1. Generator ID Number
NVD008200330

2. Page 1 of 1

3. Emergency Response Phone
(702) 353-4355

4. Waste Tracking Number
Manifest # RZE

#1657

5. Generator's Name and Mailing Address

Tronox
P.O. Box 55
Henderson, Nevada 89009 (702) 592-7727

Generator's Site Address (if different than mailing address)

Tronox LLC
560 West Lake Mead Parkway
Henderson, Nevada 89015

Generator's Phone:

6. Transporter 1 Company Name

Las Vegas Paving Corporation NDOT #0191949

U.S. EPA ID Number

NVD986768174

7. Transporter 2 Company Name

U.S. EPA ID Number

8. Designated Facility Name and Site Address

Republic Services of Nevada
Apex, Regional Landfill (702) 423-2128

U.S. EPA ID Number

Profile Number 3825 11 0022

Facility's Phone:

9. Waste Shipping Name and Description

10. Containers

No. Type

11. Total Quantity

12. Unit Wt./Vol.

1. **Regulated Asbestos Containing Material**
Mixed with soil and construction debris

Trk 14yards

2. 21.32 TU

3.

4.

13. Special Handling Instructions and Additional Information

Asbestos will be wetted down and loads shall be wrapped in 6-mil visqueen. Avoid opening wrapped loads. Breathing Asbestos is hazardous to your health.

Call (702) 353-4355, David Breault and return to Generator if undeliverable.

CCHD Permit #ATP11-010802 Expires 4/7/2011 DAQEM Project #100633

14. GENERATOR'S/OFFEROR'S CERTIFICATION: I hereby declare that the contents of this consignment are fully and accurately described above by the proper shipping name, and are classified, packaged, marked and labeled/placarded, and are in all respects in proper condition for transport according to applicable international and national governmental regulations.

Generator's/Offeor's Printed/Typed Name

Susan Crowley

Signature

Susan Crowley

Month Day Year

15. International Shipments Import to U.S. Export from U.S.

Port of entry/exit:

Date leaving U.S.:

16. Transporter Acknowledgment of Receipt of Materials

Transporter 1 Printed/Typed Name

Tony Padua

Signature

Tony Padua

Month Day Year

Transporter 2 Printed/Typed Name

Signature

Month Day Year

17. Discrepancy

17a. Discrepancy Indication Space

Quantity

Type

Residue

Partial Rejection

Full Rejection

Manifest Reference Number:

17b. Alternate Facility (or Generator)

U.S. EPA ID Number

Facility's Phone:

17c. Signature of Alternate Facility (or Generator)

Month Day Year

LVPC Job Number 966525

18. Designated Facility Owner or Operator: Certification of receipt of materials covered by the manifest except as noted in Item 17a

Printed/Typed Name

Jesse Smith

Signature

Jesse Smith

Month Day Year

2 8 11

GENERATOR

INT'L

TRANSPORTER

DESIGNATED FACILITY

81 Environmental Tech
13550 N Highway 93
Las Vegas, NV 89165

Ticket Type: INBOUND INVOICE

Ticket Number: 22855
Date: 02/04/2011
Time In: 11:02 pm
Time Out: 11:20 pm

Customer: 001011 - NGE, LLC c/o Northgate Environ Mgmt

Vehicle/Container: 192367
Contract: RZE ASBESTO SOIL 3825 11 0022
Comment: 3825-11-0022

Gross Weight: 80,400 LB Scale In
Tare Weight: 38,660 LB Scale Out
Net Weight: 41740 LB
Net Tons: 20.87

BOL: RZE0658

Origin	Yards	Material	Billing	Quantity
Not Applicable	0.00 YD	ASBESTOS FRIABLE	20.87	TN

Driver: 

Weighmaster: 

SMITHJ

Indemnification. Customer agrees, by signature above, to indemnify, hold harmless, and defend Republic Services, Inc., its subsidiaries, affiliates, employees, officers and directors from and against any and all liabilities, claims, penalties, forfeitures, suits and the costs and expenses incident thereto, including costs of defense, settlement, and reasonable attorney's fees, which may be incurred, as a result of death or injuries to any person, or damage to any property, contamination of or adverse effects on the environment, caused in whole or in part by the Customer, its employees, or subcontractors in disposing waste at this Facility. In the event Customer delivers Unacceptable Waste (as determined by Republic) Customer agrees to assume all expenses and obligations with the removal and/or resolution of any effects caused by the delivery of such Unacceptable Waste.

Indemnización. Cliente acuerda indemnizar, mantener inmune, y defender Republic Services, Inc., sus subsidiarios, compañías, divisiones, empleados, oficiales y directores contra de cualquiera y de todas responsabilidades, demandas, penas, pérdidas, juicios, pleitos y los costos incidente además, incluyendo costos de defensa, de acuerdo judicial, y de honorarios razonables del abogado, que pueden ser incurridos en, o como resultado de, la muerte o herida personal a cualquier persona, o daños a cualquier característica, propiedad, contaminación de la tierra o efectos ilícitos en esta Facilidad, causado entero o en parte por el cliente, sus empleados, o sus subcontratistas en botar basura en esta Facilidad. En el caso que el Cliente entrega, bota, basura (según lo determinado por Republic) en este Establecimiento basura inaceptable en los reglamentos de este Establecimiento, el Cliente se compromete asumir todos los costos y obligaciones con el retiro y/o la resolución de cualquier dano(s) causado por la entrega de tal basura inaceptable.

NON-HAZARDOUS WASTE MANIFEST

1. Generator ID Number
NVD008290330

2. Page 1 of
1

3. Emergency Response Phone
(702) 353-4355

4. Waste Tracking Number
Manifest # **RZE**

41658

5. Generator's Name and Mailing Address
**Trinox
P.O. Box 55
Henderson, Nevada 89009 (702) 592-7727**

Generator's Site Address (if different than mailing address)
**Trinox LLC
560 West Lake Mead Parkway
Henderson, Nevada 89015**

6. Transporter 1 Company Name
Las Vegas Paving Corporation NDOT #0191949

U.S. EPA ID Number
NVD986762174

7. Transporter 2 Company Name

U.S. EPA ID Number

8. Designated Facility Name and Site Address
**Republic Services of Nevada
Apex, Regional Landfill (702) 423-2128**

U.S. EPA ID Number

Profile Number 3825 11 0022

Facility's Phone:

9. Waste Shipping Name and Description

10. Containers
No. Type

11. Total Quantity

12. Unit Wt./Vol.

1. **Regulated Asbestos Containing Material
Mixed with soil and construction debris**

Trk 14yards

10.87 TN

3.

4.

13. Special Handling Instructions and Additional Information

**Asbestos will be wetted down and loads shall be wrapped in 6-mil visqueen. Avoid opening wrapped loads. Breathing Asbestos is hazardous to your health.
Call (702) 353-4355, David Breault and return to Generator if undeliverable.
CCHD Permit #ATP11-010802 Expires 4/7/2011 DAQEM Project #100633**

14. GENERATOR'S/OFFEROR'S CERTIFICATION: I hereby declare that the contents of this consignment are fully and accurately described above by the proper shipping name, and are classified, packaged, marked and labeled/placarded, and are in all respects in proper condition for transport according to applicable international and national governmental regulations.

Generator's/Offorer's Printed/Typed Name
Susan Crowley

Signature
Susan Crowley

Month Day Year

15. International Shipments Import to U.S. Export from U.S.

Port of entry/exit:
Date leaving U.S.:

16. Transporter Acknowledgment of Receipt of Materials

Transporter 1 Printed/Typed Name

Signature
T. Rich

Month Day Year

Transporter 2 Printed/Typed Name

Signature
T. Rich

Month Day Year
02 04 11

17. Discrepancy

17a. Discrepancy Indication Space Quantity Type Residue Partial Rejection Full Rejection

Manifest Reference Number:

17b. Alternate Facility (or Generator)

U.S. EPA ID Number

Facility's Phone:

17c. Signature of Alternate Facility (or Generator)

Month Day Year

LVPC Job Number 966525

18. Designated Facility Owner or Operator: Certification of receipt of materials covered by the manifest except as noted in Item 17a

Printed/Typed Name
Jason Smith

Signature
Jason Smith

Month Day Year

2 4 11

81 Environmental Tech
13550 N Highway 93
Las Vegas, NV 89165

Ticket Type: INBOUND INVOICE

Ticket Number: 22856
Date: 02/04/2011
Time In: 11:09 pm
Time Out: 11:27 pm

Customer: 001011 - NGE, LLC c/o Northgate Environ Mgmt

Vehicle/Container: 192358
Contract: RZE ASBESTO SOIL 3825 11 0022
Comment: 3825-11-0022

Gross Weight: 81,440 LB Scale In
Tare Weight: 39,400 LB Scale Out
Net Weight: 42040 LB
Net Tons: 21.02

BOL: RZE0659

Origin	Yards	Material	Billing	Quantity
Not Applicable	0.00 YD	ASBESTOS FRIABLE	21.02	TN

Driver: 

Weighmaster: 

SMITHJ

Indemnification. Customer agrees, by signature above, to indemnify, hold harmless, and defend Republic Services, Inc., its subsidiaries, affiliates, employees, officers and directors from and against any and all liabilities, claims, penalties, forfeitures, suits and the costs and expenses incident thereto, including costs of defense, settlement, and reasonable attorney's fees, which may be incurred, as a result of death or injuries to any person, or damage to any property, contamination of or adverse effects on the environment, caused in whole or in part by the Customer, its employees, or subcontractors in disposing waste at this Facility. In the event Customer delivers Unacceptable Waste (as determined by Republic) Customer agrees to assume all expenses and obligations with the removal and/or resolution of any effects caused by the delivery of such Unacceptable Waste.

Indemnización. Cliente acuerda indemnizar, mantener inmune, y defender Republic Services, Inc., sus subsidiarios, compañías, divisiones, empleados, oficiales y directores contra de cualquiera y de todas responsabilidades, demandas, penas, pérdidas, juicios, pleitos y los costos incidente además, incluyendo costos de defensa, de acuerdo judicial, y de honorarios razonables del abogado, que pueden ser incurridos en, o como resultado de, la muerte o herida personal a cualquier persona, o daños a cualquier característica, propiedad, contaminación de la tierra o efectos ilícitos en esta Facilidad, causado entero o en parte por el cliente, sus empleados, o sus subcontratistas en botar basura en esta Facilidad. En el caso que el Cliente entrega, bota, basura (según lo determinado por Republic) en este Establecimiento basura inaceptable en los reglamentos de este Establecimiento, el Cliente se compromete asumir todos los costos y obligaciones con el retiro y/o la resolución de cualquier dano(s) causado por la entrega de tal basura inaceptable.

NON-HAZARDOUS WASTE MANIFEST

1. Generator ID Number
NVD008290330

2. Page 1 of 1

3. Emergency Response Phone
(702) 353-4355

4. Waste Tracking Number
Manifest # RZE 41859

5. Generator's Name and Mailing Address
Tronox
P.O. Box 55
Henderson, Nevada 89009 (702) 592-7127

Generator's Site Address (if different than mailing address)
Tronox LLC
560 West Lake Mead Parkway
Henderson, Nevada 89015

Generator's Phone:
6. Transporter 1 Company Name: **Las Vegas Paving Corporation** NDOT #0191949 U.S. EPA ID Number: **NVD988768174**

7. Transporter 2 Company Name: U.S. EPA ID Number:

8. Designated Facility Name and Site Address: **Republic Services of Nevada**
Apex, Regional Landfill (702) 423-2128 U.S. EPA ID Number:
Profile Number 3825 11 0022

9. Waste Shipping Name and Description	10. Containers		11. Total Quantity	12. Unit Wt./Vol.
	No.	Type		
1. Regulated Asbestos Containing Material Mixed with soil and construction debris		Trk	14yards	
2.			21.02	TU
3.				
4.				

13. Special Handling Instructions and Additional Information
Asbestos will be wetted down and loads shall be wrapped in 6-mil visqueen. Avoid opening wrapped loads. Breathing Asbestos is hazardous to your health.
Call (702) 353-4355, David Breaux and return to Generator if undeliverable.
CCHD Permit #ATP11-010802 Expires 4/1/2011 DAQEM Project #100633

14. GENERATOR'S/OFFEROR'S CERTIFICATION: I hereby declare that the contents of this consignment are fully and accurately described above by the proper shipping name, and are classified, packaged, marked and labeled/placarded, and are in all respects in proper condition for transport according to applicable international and national governmental regulations.

Generator's/Offeror's Printed/Typed Name: **Susan Crowley** Signature: *Susan Crowley* Month: Day: Year:

15. International Shipments Import to U.S. Export from U.S. Port of entry/exit: Date leaving U.S.:

16. Transporter Acknowledgment of Receipt of Materials

Transporter 1 Printed/Typed Name: *Brian Brunkhoff* Signature: *Brian Brunkhoff* Month: Day: Year: **2 4 11**

Transporter 2 Printed/Typed Name: Signature: Month: Day: Year:

17. Discrepancy
17a. Discrepancy Indication Space Quantity Type Residue Partial Rejection Full Rejection
Manifest Reference Number: U.S. EPA ID Number:

17b. Alternate Facility (or Generator): U.S. EPA ID Number:

Facility's Phone:
17c. Signature of Alternate Facility (or Generator): Month: Day: Year:

LVPC Job Number 966525

18. Designated Facility Owner or Operator: Certification of receipt of materials covered by the manifest except as noted in Item 17a
Printed/Typed Name: *Jason J...* Signature: *Jason J...* Month: Day: Year: **2 4 11**

GENERATOR

TRANSPORTER INT'L

DESIGNATED FACILITY

81 Environmental Tech
13550 N Highway 93
Las Vegas, NV 89165

Ticket Type: INBOUND INVOICE

Ticket Number: 22857
Date: 02/04/2011
Time In: 11:13 pm
Time Out: 11:30 pm

Customer: 001011 - NGE, LLC c/o Northgate Environ Mgmt

Vehicle/Container: 192310
Contract: RZE ASBESTO SOIL 3825 11 0022
Comment: 3825-11-0022

Gross Weight: 80,860 LB Scale In
Tare Weight: 38,280 LB Scale Out
Net Weight: 42580 LB
Net Tons: 21.29

BOL: RZE0660

Origin	Yards	Material	Billing	Quantity
Not Applicable	0.00 YD	ASBESTOS FRIABLE	21.29	TN

Driver:

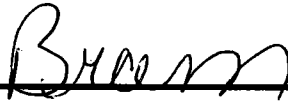

Weighmaster:

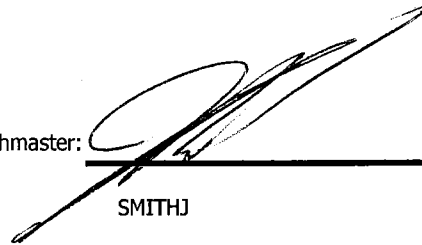
SMITHJ

Indemnification. Customer agrees, by signature above, to indemnify, hold harmless, and defend Republic Services, Inc., its subsidiaries, affiliates, employees, officers and directors from and against any and all liabilities, claims, penalties, forfeitures, suits and the costs and expenses incident thereto, including costs of defense, settlement, and reasonable attorney's fees, which may be incurred, as a result of death or injuries to any person, or damage to any property, contamination of or adverse effects on the environment, caused in whole or in part by the Customer, its employees, or subcontractors in disposing waste at this Facility. In the event Customer delivers Unacceptable Waste (as determined by Republic) Customer agrees to assume all expenses and obligations with the removal and/or resolution of any effects caused by the delivery of such Unacceptable Waste.

Indemnización. Cliente acuerda indemnizar, mantener inmune, y defender Republic Services, Inc., sus subsidiarios, compañías, divisiones, empleados, oficiales y directores contra de cualquiera y de todas responsabilidades, demandas, penas, pérdidas, juicios, pleitos y los costos incidente además, incluyendo costos de defensa, de acuerdo judicial, y de honorarios razonables del abogado, que pueden ser incurridos en, o como resultado de, la muerte o herida personal a cualquier persona, o daños a cualquier característica, propiedad, contaminación de la tierra o efectos ilícitos en esta Facilidad, causado entero o en parte por el cliente, sus empleados, o sus subcontratistas en botar basura en esta Facilidad. En el caso que el Cliente entrega, bota, basura (según lo determinado por Republic) en este Establecimiento basura inaceptable en los reglamentos de este Establecimiento, el Cliente se compromete asumir todos los costos y obligaciones con el retiro y/o la resolución de cualquier dano(s) causado por la entrega de tal basura inaceptable.

NON-HAZARDOUS WASTE MANIFEST		1. Generator ID Number: NVD008290330	2. Page 1 of 1	3. Emergency Response Phone (702) 353-4355	4. Waste Tracking Number Manifest # RZE #14660	
5. Generator's Name and Mailing Address Tronox P.O. Box 55 Henderson, Nevada 89009 (702) 592-7727				Generator's Site Address (if different than mailing address) Tronox LLC 560 West Lake Mead Parkway Henderson, Nevada 89015		
6. Transporter 1 Company Name Las Vegas Paving Corporation				NDOT # 0191949		U.S. EPA ID Number NVD986768174
7. Transporter 2 Company Name				U.S. EPA ID Number		
8. Designated Facility Name and Site Address Republic Services of Nevada Apex, Regional Landfill (702) 423-2128				U.S. EPA ID Number Profile Number 3825 11 0022		
Facility's Phone:						
9. Waste Shipping Name and Description		10. Containers		11. Total Quantity	12. Unit Wt./Vol.	
		No.	Type			
1.	Regulated Asbestos Containing Material Mixed with soil and construction debris		Trk	14yards		
2.				21.29	TN	
3.						
4.						
13. Special Handling Instructions and Additional Information Asbestos will be wetted down and loads shall be wrapped in 6-mil visqueen. Avoid opening wrapped loads. Breathing Asbestos is hazardous to your health. Call (702) 353-4355, David Breslett and return to Generator if undeliverable. CCHD Permit #ATP11-010802 Expires 4/7/2011 DAQEM Project #100633						
14. GENERATOR'S/OFFEROR'S CERTIFICATION: I hereby declare that the contents of this consignment are fully and accurately described above by the proper shipping name, and are classified, packaged, marked and labeled/placarded, and are in all respects in proper condition for transport according to applicable international and national governmental regulations.						
Generator's/Offorer's Printed/Typed Name Susan Crowley				Signature <i>Susan Crowley</i>		Month Day Year
15. International Shipments <input type="checkbox"/> Import to U.S. <input type="checkbox"/> Export from U.S. Port of entry/exit: Transporter Signature (for exports only): Date leaving U.S.:						
16. Transporter Acknowledgment of Receipt of Materials						
Transporter 1 Printed/Typed Name <i>B. Ham</i>				Signature <i>B. Ham</i>		Month Day Year
Transporter 2 Printed/Typed Name				Signature		Month Day Year
17. Discrepancy						
17a. Discrepancy Indication Space <input type="checkbox"/> Quantity <input type="checkbox"/> Type <input type="checkbox"/> Residue <input type="checkbox"/> Partial Rejection <input type="checkbox"/> Full Rejection						
17b. Alternate Facility (or Generator)				Manifest Reference Number:		U.S. EPA ID Number
Facility's Phone:						
17c. Signature of Alternate Facility (or Generator)				Month Day Year		
LVPC Job Number 966525						
18. Designated Facility Owner or Operator: Certification of receipt of materials covered by the manifest except as noted in Item 17a						
Printed/Typed Name <i>Jc. Soe Jim 7/</i>				Signature <i>Jc. Soe Jim</i>		Month Day Year 2 4 11

GENERATOR

INT'L

TRANSPORTER

DESIGNATED FACILITY

81 Environmental Tech
13550 N Highway 93
Las Vegas, NV 89165

Ticket Type: INBOUND INVOICE

Ticket Number: 22858
Date: 02/04/2011
Time In: 11:19 pm
Time Out: 11:34 pm

Customer: 001011 - NGE, LLC c/o Northgate Environ Mgmt

Vehicle/Container: 192312
Contract: RZE ASBESTO SOIL 3825 11 0022
Comment: 3825-11-0022

Gross Weight: 79,380 LB Scale In
Tare Weight: 38,280 LB Scale Out
Net Weight: 41100 LB
Net Tons: 20.55

BOL: RZE0662

Origin	Yards	Material	Billing Quantity
Not Applicable	0.00 YD	ASBESTOS FRIABLE	20.55 TN

Driver: _____

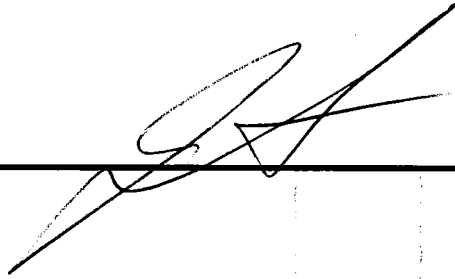

Weighmaster: _____

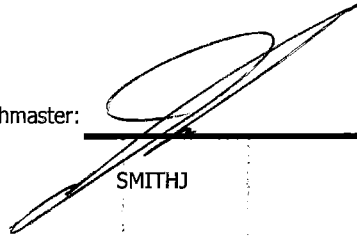

SMITHJ

Indemnification. Customer agrees, by signature above, to indemnify, hold harmless, and defend Republic Services, Inc., its subsidiaries, affiliates, employees, officers and directors from, and against any and all liabilities, claims, penalties, forfeitures, suits and the costs and expenses incident thereto, including costs of defense, settlement, and reasonable attorney's fees, which may be incurred, as a result of death or injuries to any person, or damage to any property, contamination of or adverse effects on the environment, caused in whole or in part by the Customer, its employees, or subcontractors in disposing waste at this Facility. In the event Customer delivers Unacceptable Waste (as determined by Republic) Customer agrees to assume all expenses and obligations with the removal and/or resolution of any effects caused by the delivery of such Unacceptable Waste.

Indemnización. Cliente acuerda indemnizar, mantener inmune, y defender Republic Services, Inc., sus subsidiarios, compañías, divisiones, empleados, oficiales y directores contra de cualquiera y de todas responsabilidades, demandas, penas, pérdidas, juicios, pleitos y los costos incidente además, incluyendo costos de defensa, de acuerdo judicial, y de honorarios razonables del abogado, que pueden ser incurridos en, o como resultado de, la muerte o herida personal a cualquier persona, o daños a cualquier característica, propiedad, contaminación de la tierra o efectos ilícitos en esta Facilidad, causado entero o en parte por el cliente, sus empleados, o sus subcontratistas en botar basura en esta Facilidad. En el caso que el Cliente entrega, bota, basura (según lo determinado por Republic) en este Establecimiento basura inaceptable en los reglamentos de este Establecimiento, el Cliente se compromete asumir todos los costos y obligaciones con el retiro y/o la resolución de cualquier dano(s) causado por la entrega de tal basura inaceptable.

NON-HAZARDOUS WASTE MANIFEST

1. Generator ID Number: **NVD008290330**
 2. Page 1 of 1
 3. Emergency Response Phone: **(702) 353-4355**
 4. Waste Tracking Number: **Manifest # RFE #1662**

5. Generator's Name and Mailing Address: **Ironox P.O. Box 53 Henderson, Nevada 89009 (702) 592-7727**
 Generator's Site Address (if different than mailing address): **Ironox LLC 560 West Lake Mead Parkway Henderson, Nevada 89015**

6. Transporter 1 Company Name: **Las Vegas Paving Corporation** NDOT #0191949
 U.S. EPA ID Number: **NVD980768174**

7. Transporter 2 Company Name: _____ U.S. EPA ID Number: _____

8. Designated Facility Name and Site Address: **Republic Services of Nevada Apex, Regional Landfill (702) 423-2128**
 Profile Number: **3825 11 0022**
 Facility's Phone: _____ U.S. EPA ID Number: _____

9. Waste Shipping Name and Description	10. Containers		11. Total Quantity	12. Unit Wt./Vol.
	No.	Type		
1. Regulated Asbestos Containing Material Mixed with soil and construction debris		Trk	14yards	
2.			10.55	
3.				
4.				

13. Special Handling Instructions and Additional Information:
Asbestos will be wetted down and loads shall be wrapped in 6-mil visqueen. Avoid opening wrapped loads. Breathing Asbestos is hazardous to your health. Call (702) 353-4355, David Breault and return to Generator if undeliverable. CCHD Permit #ATP11-010802. Expires 4/7/2011. DAQEM Project #100633

14. GENERATOR'S/OFFEROR'S CERTIFICATION: I hereby declare that the contents of this consignment are fully and accurately described above by the proper shipping name, and are classified, packaged, marked and labeled/placarded, and are in all respects in proper condition for transport according to applicable international and national governmental regulations.
 Generator's/Offorer's Printed/Typed Name: **Susan Crowley** Signature: *[Signature]* Month: _____ Day: _____ Year: _____

15. International Shipments Import to U.S. Export from U.S. Port of entry/exit: _____ Date leaving U.S.: _____

16. Transporter Acknowledgment of Receipt of Materials
 Transporter 1 Printed/Typed Name: _____ Signature: *[Signature]* Month: _____ Day: _____ Year: _____
 Transporter 2 Printed/Typed Name: _____ Signature: _____ Month: _____ Day: _____ Year: _____

17. Discrepancy
 17a. Discrepancy Indication Space Quantity Type Residue Partial Rejection Full Rejection
 Manifest Reference Number: _____ U.S. EPA ID Number: _____

17b. Alternate Facility (or Generator): _____ U.S. EPA ID Number: _____
 Facility's Phone: _____
 17c. Signature of Alternate Facility (or Generator): _____ Month: _____ Day: _____ Year: _____

LVPC Job Number 966525

18. Designated Facility Owner or Operator: Certification of receipt of materials covered by the manifest except as noted in Item 17a
 Printed/Typed Name: *[Signature]* Signature: *[Signature]* Month: **2** Day: **4** Year: **//**

GENERATOR
INT'L
TRANSPORTER
DESIGNATED FACILITY

81 Environmental Tech
13550 N Highway 93
Las Vegas, NV 89165

Ticket Type: INBOUND INVOICE

Ticket Number: 22859
Date: 02/04/2011
Time In: 11:23 pm
Time Out: 11:39 pm

Customer: 001011 - NGE, LLC c/o Northgate Environ Mgmt

Vehicle/Container: 192308
Contract: RZE ASBESTO SOIL 3825 11 0022
Comment: 3825-11-0022

Gross Weight: 83,500 LB Scale In
Tare Weight: 39,940 LB Scale Out
Net Weight: 43560 LB
Net Tons: 21.78

BOL: RZE0663

Origin	Yards	Material	Billing	Quantity
Not Applicable	0.00 YD	ASBESTOS FRIABLE	21.78	TN

Driver:

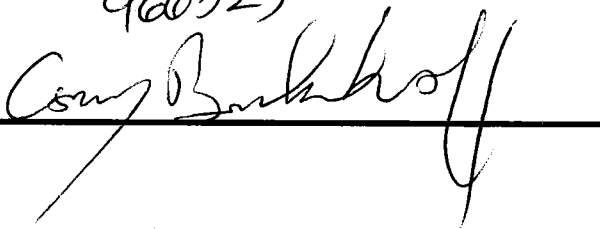
960525

Weighmaster:

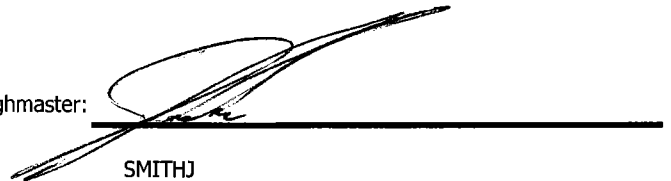
SMITHJ

Indemnification. Customer agrees, by signature above, to indemnify, hold harmless, and defend Republic Services, Inc., its subsidiaries, affiliates, employees, officers and directors from and against any and all liabilities, claims, penalties, forfeitures, suits and the costs and expenses incident thereto, including costs of defense, settlement, and reasonable attorney's fees, which may be incurred, as a result of death or injuries to any person, or damage to any property, contamination of or adverse effects on the environment, caused in whole or in part by the Customer, its employees, or subcontractors in disposing waste at this Facility. In the event Customer delivers Unacceptable Waste (as determined by Republic) Customer agrees to assume all expenses and obligations with the removal and/or resolution of any effects caused by the delivery of such Unacceptable Waste.

Indemnización. Cliente acuerda indemnizar, mantener inmune, y defender Republic Services, Inc., sus subsidiarios, compañías, divisiones, empleados, oficiales y directores contra de cualquiera y de todas responsabilidades, demandas, penas, pérdidas, juicios, pleitos y los costos incidente además, incluyendo costos de defensa, de acuerdo judicial, y de honorarios razonables del abogado, que pueden ser incurridos en, o como resultado de, la muerte o herida personal a cualquier persona, o daños a cualquier característica, propiedad, contaminación de la tierra o efectos ilícitos en esta Facilidad, causado entero o en parte por el cliente, sus empleados, o sus subcontratistas en botar basura en esta Facilidad. En el caso que el Cliente entrega, bota, basura (según lo determinado por Republic) en este Establecimiento basura inaceptable en los reglamentos de este Establecimiento, el Cliente se compromete asumir todos los costos y obligaciones con el retiro y/o la resolución de cualquier dano(s) causado por la entrega de tal basura inaceptable.

NON-HAZARDOUS WASTE MANIFEST

1. Generator ID Number
NVD008290330

2. Page 1 of 1

3. Emergency Response Phone
(702) 353-4355

4. Waste Tracking Number
Manifest # RZE #663

5. Generator's Name and Mailing Address
Tronox
P.O. Box 55
Henderson, Nevada 89009 (702) 592-7727

Generator's Site Address (if different than mailing address)
Tronox LLC
560 West Lake Mead Parkway
Henderson, Nevada 89015

Generator's Phone:

6. Transporter 1 Company Name
Las Vegas Paving Corporation NDOT #0191949

U.S. EPA ID Number
NVD986768174

7. Transporter 2 Company Name

U.S. EPA ID Number

8. Designated Facility Name and Site Address

U.S. EPA ID Number

Republic Services of Nevada
Apex, Regional Landfill (702) 423-2128

Profile Number 3825 11 0022

Facility's Phone:

9. Waste Shipping Name and Description	10. Containers		11. Total Quantity	12. Unit Wt./Vol.
	No.	Type		
1. Regulated Asbestos Containing Material Mixed with soil and construction debris		Trk	14yards	
2.			21.78	TU
3.				
4.				

13. Special Handling Instructions and Additional Information

Asbestos will be wetted down and loads shall be wrapped in 6-mil visqueen. Avoid opening wrapped loads. Breathing Asbestos is hazardous to your health.

Call (702) 353-4355, David Breault and return to Generator if undeliverable.

CCHD Permit #ATP11010802 Expires 4/7/2011 DAQEM Project #100633

14. GENERATOR'S/OFFEROR'S CERTIFICATION: I hereby declare that the contents of this consignment are fully and accurately described above by the proper shipping name, and are classified, packaged, marked and labeled/placarded, and are in all respects in proper condition for transport according to applicable international and national governmental regulations.

Generator's/Offoror's Printed/Typed Name

Susan Crowley

Signature

Susan Crowley

Month Day Year

INT'L

15. International Shipments

Import to U.S.

Export from U.S.

Port of entry/exit:

Date leaving U.S.:

16. Transporter Acknowledgment of Receipt of Materials

Transporter 1 Printed/Typed Name

Carey Brinkerhoff

Signature

Carey Brinkerhoff

Month Day Year

2 24 11

Transporter 2 Printed/Typed Name

Signature

Month Day Year

TRANSPORTER

17. Discrepancy

17a. Discrepancy Indication Space

Quantity

Type

Residue

Partial Rejection

Full Rejection

Manifest Reference Number:

17b. Alternate Facility (or Generator)

U.S. EPA ID Number

Facility's Phone:

17c. Signature of Alternate Facility (or Generator)

Month Day Year

LVPC Job Number 966525

18. Designated Facility Owner or Operator: Certification of receipt of materials covered by the manifest except as noted in Item 17a

Printed/Typed Name

JK See Smith

Signature

JK See Smith

Month Day Year

2 4 11

81 Environmental Tech
13550 N Highway 93
Las Vegas, NV 89165

Ticket Type: INBOUND INVOICE

Ticket Number: 22860
Date: 02/04/2011
Time In: 11:25 pm
Time Out: 11:42 pm

Customer: 001011 - NGE, LLC c/o Northgate Environ Mgmt

Vehicle/Container: 192334
Contract: RZE ASBESTO SOIL 3825 11 0022
Comment: 3825-11-0022

Gross Weight: 78,600 LB Scale In
Tare Weight: 37,200 LB Scale Out
Net Weight: 41400 LB
Net Tons: 20.70

BOL: RZE0664

Origin	Yards	Material	Billing Quantity
Not Applicable	0.00 YD	ASBESTOS FRIABLE	20.70 TN

Driver: _____

Weighmaster: _____

SMITHJ

Indemnification. Customer agrees, by signature above, to indemnify, hold harmless, and defend Republic Services, Inc., its subsidiaries, affiliates, employees, officers and directors from and against any and all liabilities, claims, penalties, forfeitures, suits and the costs and expenses incident thereto, including costs of defense, settlement, and reasonable attorney's fees, which may be incurred, as a result of death or injuries to any person, or damage to any property, contamination of or adverse effects on the environment, caused in whole or in part by the Customer, its employees, or subcontractors in disposing waste at this Facility. In the event Customer delivers Unacceptable Waste (as determined by Republic) Customer agrees to assume all expenses and obligations with the removal and/or resolution of any effects caused by the delivery of such Unacceptable Waste.

Indemnización. Cliente acuerda indemnizar, mantener inmune, y defender Republic Services, Inc., sus subsidiarios, compañías, divisiones, empleados, oficiales y directores contra de cualquiera y de todas responsabilidades, demandas, penas, pérdidas, juicios, pleitos y los costos incidente además, incluyendo costos de defensa, de acuerdo judicial, y de honorarios razonables del abogado, que pueden ser incurridos en, o como resultado de, la muerte o herida personal a cualquier persona, o daños a cualquier característica, propiedad, contaminación de la tierra o efectos ilícitos en esta Facilidad, causado entero o en parte por el cliente, sus empleados, o sus subcontratistas en botar basura en esta Facilidad. En el caso que el Cliente entrega, bota, basura (según lo determinado por Republic) en este Establecimiento basura inaceptable en los reglamentos de este Establecimiento, el Cliente se compromete asumir todos los costos y obligaciones con el retiro y/o la resolución de cualquier dano(s) causado por la entrega de tal basura inaceptable.

NON-HAZARDOUS WASTE MANIFEST

1. Generator ID Number
NVD008290330

2. Page 1 of 1

3. Emergency Response Phone
(702) 353-4355

4. Waste Tracking Number
Manifest # **RLE**

8664

5. Generator's Name and Mailing Address
Trinox
P.O. Box 55
Henderson, Nevada 89009 (702) 592-7727

Generator's Site Address (if different than mailing address)
Trinox LLC
560 West Lake Mead Parkway
Henderson, Nevada 89015

6. Transporter 1 Company Name
Las Vegas Paving Corporation NDOT #0191949

U.S. EPA ID Number
NVD988788174

7. Transporter 2 Company Name

U.S. EPA ID Number

8. Designated Facility Name and Site Address
Republic Services of Nevada
Apex, Regional Landfill (702) 423-2128

U.S. EPA ID Number
Profile Number 3825 11 0022

9. Waste Shipping Name and Description	10. Containers		11. Total Quantity	12. Unit Wt./Vol.
	No.	Type		
1. Regulated Asbestos Containing Material Mixed with soil and construction debris		Trk	14 yards	
2.			10.70	TD
3.				
4.				

13. Special Handling Instructions and Additional Information
Asbestos will be wetted down and loads shall be wrapped in 6-mil visqueen. Avoid opening wrapped loads. Breathing Asbestos is hazardous to your health.
Call (702) 353-4355, David Breault and return to Generator if undeliverable.
CCHD Permit #ATP11-010602 Expires 4/7/2011 **DAQEM Project #100633**

14. GENERATOR'S/OFFEROR'S CERTIFICATION: I hereby declare that the contents of this consignment are fully and accurately described above by the proper shipping name, and are classified, packaged, marked and labeled/placarded, and are in all respects in proper condition for transport according to applicable international and national governmental regulations.

Generator's/Offoror's Printed/Typed Name: **Susan Crowley**
Signature: *[Signature]*
Month: Day: Year:

15. International Shipments Import to U.S. Export from U.S.
Port of entry/exit: _____
Transporter Signature (for exports only): _____
Date leaving U.S.: _____

16. Transporter Acknowledgment of Receipt of Materials

Transporter 1 Printed/Typed Name	Signature	Month	Day	Year
<i>[Signature]</i>	<i>[Signature]</i>	2	9	11
Transporter 2 Printed/Typed Name	Signature	Month	Day	Year

17. Discrepancy

17a. Discrepancy Indication Space Quantity Type Residue Partial Rejection Full Rejection

Manifest Reference Number: _____

17b. Alternate Facility (or Generator) _____ U.S. EPA ID Number _____
Facility's Phone: _____

17c. Signature of Alternate Facility (or Generator) _____ Month: Day: Year:

LVPC Job Number 966525

18. Designated Facility Owner or Operator: Certification of receipt of materials covered by the manifest except as noted in Item 17a

Printed/Typed Name: *[Signature]*
Signature: *[Signature]*
Month: Day: Year: 2 4 11

81 Environmental Tech
13550 N Highway 93
Las Vegas, NV 89165

Ticket Type: INBOUND INVOICE

Ticket Number: 22861
Date: 02/04/2011
Time In: 11:25 pm
Time Out: 11:44 pm

Customer: 001011 - NGE, LLC c/o Northgate Environ Mgmt

Vehicle/Container: 192391
Contract: RZE ASBESTO SOIL 3825 11 0022
Comment: 3825-11-0022

Gross Weight: 79,200 LB Scale In
Tare Weight: 38,960 LB Scale Out
Net Weight: 40240 LB
Net Tons: 20.12

BOL: RZE0661

Origin	Yards	Material	Billing	Quantity
Not Applicable	0.00 YD	ASBESTOS FRIABLE	20.12	TN

Driver: _____

Weighmaster: _____

SMITHJ

Indemnification. Customer agrees, by signature above, to indemnify, hold harmless, and defend Republic Services, Inc., its subsidiaries, affiliates, employees, officers and directors from and against any and all liabilities, claims, penalties, forfeitures, suits and the costs and expenses incident thereto, including costs of defense, settlement, and reasonable attorney's fees, which may be incurred, as a result of death or injuries to any person, or damage to any property, contamination of or adverse effects on the environment, caused in whole or in part by the Customer, its employees, or subcontractors in disposing waste at this Facility. In the event Customer delivers Unacceptable Waste (as determined by Republic) Customer agrees to assume all expenses and obligations with the removal and/or resolution of any effects caused by the delivery of such Unacceptable Waste.

Indemnización. Cliente acuerda indemnizar, mantener inmune, y defender Republic Services, Inc., sus subsidiarios, compañías, divisiones, empleados, oficiales y directores contra de cualquiera y de todas responsabilidades, demandas, penas, pérdidas, juicios, pleitos y los costos incidente además, incluyendo costos de defensa, de acuerdo judicial, y de honorarios razonables del abogado, que pueden ser incurridos en, o como resultado de, la muerte o herida personal a cualquier persona, o daños a cualquier característica, propiedad, contaminación de la tierra o efectos ilícitos en esta Facilidad, causado entero o en parte por el cliente, sus empleados, o sus subcontratistas en botar basura en esta Facilidad. En el caso que el Cliente entrega, bota, basura (según lo determinado por Republic) en este Establecimiento basura inaceptable en los reglamentos de este Establecimiento, el Cliente se compromete asumir todos los costos y obligaciones con el retiro y/o la resolución de cualquier dano(s) causado por la entrega de tal basura inaceptable.

81 Environmental Tech
13550 N Highway 93
Las Vegas, NV 89165

Ticket Type: INBOUND INVOICE

Ticket Number: 22862
Date: 02/04/2011
Time In: 11:35 pm
Time Out: 11:55 pm

Customer: 001011 - NGE, LLC c/o Northgate Environ Mgmt

Vehicle/Container: 192307
Contract: RZE ASBESTO SOIL 3825 11 0022
Comment: 3825-11-0022

Gross Weight: 84,080 LB Scale In
Tare Weight: 39,620 LB Scale Out
Net Weight: 44460 LB
Net Tons: 22.23

BOL: RZE0665

Origin	Yards	Material	Billing Quantity
Not Applicable	0.00 YD	ASBESTOS FRIABLE	22.23 TN

Driver:

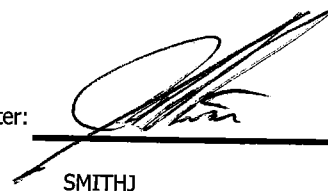

Weighmaster:

SMITHJ

Indemnification. Customer agrees, by signature above, to indemnify, hold harmless, and defend Republic Services, Inc., its subsidiaries, affiliates, employees, officers and directors from and against any and all liabilities, claims, penalties, forfeitures, suits and the costs and expenses incident thereto, including costs of defense, settlement, and reasonable attorney's fees, which may be incurred, as a result of death or injuries to any person, or damage to any property, contamination of or adverse effects on the environment, caused in whole or in part by the Customer, its employees, or subcontractors in disposing waste at this Facility. In the event Customer delivers Unacceptable Waste (as determined by Republic) Customer agrees to assume all expenses and obligations with the removal and/or resolution of any effects caused by the delivery of such Unacceptable Waste.

Indemnización. Cliente acuerda indemnizar, mantener inmune, y defender Republic Services, Inc., sus subsidiarios, compañías, divisiones, empleados, oficiales y directores contra de cualquiera y de todas responsabilidades, demandas, penas, pérdidas, juicios, pleitos y los costos incidente además, incluyendo costos de defensa, de acuerdo judicial, y de honorarios razonables del abogado, que pueden ser incurridos en, o como resultado de, la muerte o herida personal a cualquier persona, o daños a cualquier característica, propiedad, contaminación de la tierra o efectos ilícitos en esta Facilidad, causado entero o en parte por el cliente, sus empleados, o sus subcontratistas en botar basura en esta Facilidad. En el caso que el Cliente entrega, bota, basura (según lo determinado por Republic) en este Establecimiento basura inaceptable en los reglamentos de este Establecimiento, el Cliente se compromete asumir todos los costos y obligaciones con el retiro y/o la resolución de cualquier dano(s) causado por la entrega de tal basura inaceptable.

NON-HAZARDOUS WASTE MANIFEST

1. Generator ID Number
NVD008290330

2. Page 1 of 1

3. Emergency Response Phone
(702) 353-4355

4. Waste Tracking Number
Manifest # RZE

65

5. Generator's Name and Mailing Address
Ironox
P.O. Box 55
Henderson, Nevada 89009 (702) 592-7727

Generator's Site Address (if different than mailing address)
Ironox LLC
560 West Lake Mead Parkway
Henderson, Nevada 89015

Generator's Phone:

6. Transporter 1 Company Name
Las Vegas Paving Corporation NDOT #0191949

U.S. EPA ID Number
NVD988768174

7. Transporter 2 Company Name

U.S. EPA ID Number

8. Designated Facility Name and Site Address
Republic Services of Nevada
Apex, Regional Landfill (702) 423-2128
Facility's Phone:

U.S. EPA ID Number

Profile Number 3825 11 0022

9. Waste Shipping Name and Description

10. Containers
No. Type

11. Total Quantity
12. Unit Wt./Vol.

1. **Regulated Asbestos Containing Material**
Mixed with soil and construction debris

Trk

14 yards

2.

22.13 TU

3.

4.

13. Special Handling Instructions and Additional Information
Asbestos will be wetted down and loads shall be wrapped in 6-mil visqueen. Avoid opening wrapped loads. Breathing Asbestos is hazardous to your health.
Call (702) 353-4355, David Breault and return to Generator if undeliverable.
CCHD Permit #ATP11-010602 Expires 4/7/2011 **DAQEM Project #100633**

14. GENERATOR'S/OFFEROR'S CERTIFICATION: I hereby declare that the contents of this consignment are fully and accurately described above by the proper shipping name, and are classified, packaged, marked and labeled/placarded, and are in all respects in proper condition for transport according to applicable international and national governmental regulations.

Generator's/Offor's Printed/Typed Name
Susan Crowley

Signature *Susan Crowley* Month Day Year

15. International Shipments Import to U.S. Export from U.S. Port of entry/exit: Date leaving U.S.:

16. Transporter Acknowledgment of Receipt of Materials

Transporter 1 Printed/Typed Name
Mary M Dixon

Signature *Mary M Dixon* Month Day Year
2 4 11

Transporter 2 Printed/Typed Name

Signature Month Day Year

17. Discrepancy

17a. Discrepancy Indication Space Quantity Type Residue Partial Rejection Full Rejection

17b. Alternate Facility (or Generator) Manifest Reference Number: U.S. EPA ID Number

Facility's Phone:

17c. Signature of Alternate Facility (or Generator) Month Day Year

LVPC Job Number 966525

18. Designated Facility Owner or Operator: Certification of receipt of materials covered by the manifest except as noted in Item 17a

Printed/Typed Name
Tara Smith

Signature *Tara Smith* Month Day Year
2 4 11

GENERATOR

TRANSPORTER

DESIGNATED FACILITY

81 Environmental Tech
13550 N Highway 93
Las Vegas, NV 89165

Ticket Type: INBOUND INVOICE

Ticket Number: 22863
Date: 02/04/2011
Time In: 11:40 pm
Time Out: 11:59 pm

Customer: 001011 - NGE, LLC c/o Northgate Environ Mgmt

Vehicle/Container: 192393
Contract: RZE ASBESTO SOIL 3825 11 0022
Comment: 3825-11-0022

Gross Weight: 85,320 LB Scale In
Tare Weight: 41,680 LB Scale Out
Net Weight: 43640 LB
Net Tons: 21.82

BOL: RZE0666

Origin	Yards	Material	Billing	Quantity
Not Applicable	0.00 YD	ASBESTOS FRIABLE	21.82	TN

Driver:



Weighmaster:

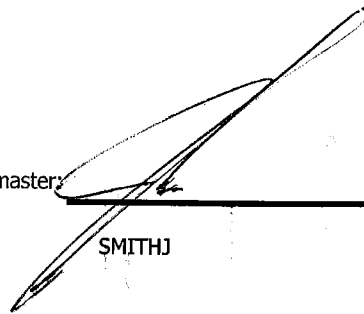

SMITHJ

Indemnification. Customer agrees, by signature above, to indemnify, hold harmless, and defend Republic Services, Inc., its subsidiaries, affiliates, employees, officers and directors from and against any and all liabilities, claims, penalties, forfeitures, suits and the costs and expenses incident thereto, including costs of defense, settlement, and reasonable attorney's fees, which may be incurred, as a result of death or injuries to any person, or damage to any property, contamination of or adverse effects on the environment, caused in whole or in part by the Customer, its employees, or subcontractors in disposing waste at this Facility. In the event Customer delivers Unacceptable Waste (as determined by Republic) Customer agrees to assume all expenses and obligations with the removal and/or resolution of any effects caused by the delivery of such Unacceptable Waste.

Indemnización. Cliente acuerda indemnizar, mantener inmune, y defender Republic Services, Inc., sus subsidiarios, companias, divisiones, empleados, oficiales y directores contra de cualquiera y de todas responsabilidades, demandas, penas, pérdidas, juicios, pleitos y los costos incidente además, incluyendo costos de defensa, de acuerdo judicial, y de honorarios razonables del abogado, que pueden ser incurridos en, o como resultado de, la muerte o herida personal a cualquier persona, o daños a cualquier característica, propiedad, contaminación de la tierra o efectos ilicitos en esta Facilidad, causado entero o en parte por el cliente, sus empleados, o sus subcontratistas en botar basura en esta Facilidad. En el caso que el Cliente entrega, bota, basura (según lo determinado por Republic) en este Establecimiento basura inaceptable en los reglamentos de este Establecimiento, el Cliente se compromete asumir todos los costos y obligaciones con el retiro y/o la resolución de cualquier dano(s) causado por la entrega de tal basura inaceptable.

**NON-HAZARDOUS
WASTE MANIFEST**

1. Generator ID Number
NVD008290330

2. Page 1 of
1

3. Emergency Response Phone
(702) 353-4355

4. Waste Tracking Number
Manifest # RZE 666

5. Generator's Name and Mailing Address
**Tronox
P.O. Box 55
Henderson, Nevada 89009 (702) 592-7727**

Generator's Site Address (if different than mailing address)
**Tronox LLC
560 West Lake Mead Parkway
Henderson, Nevada 89015**

6. Transporter 1 Company Name
Las Vegas Paving Corporation NDOT #0191949

U.S. EPA ID Number
NVD986768174

7. Transporter 2 Company Name

U.S. EPA ID Number

8. Designated Facility Name and Site Address
**Republic Services of Nevada
Apex, Regional Landfill (702) 423-2128**

U.S. EPA ID Number
Profile Number 3825 11 0022

Facility's Phone:

9. Waste Shipping Name and Description

10. Containers
No. Type

11. Total
Quantity

12. Unit
Wt./Vol.

1. **Regulated Asbestos Containing Material
Mixed with soil and construction debris**

Trk 14yards

2182 TU

3.

4.

13. Special Handling Instructions and Additional Information

**Asbestos will be wetted down and loads shall be wrapped in 6-mil visqueen. Avoid opening wrapped loads. Breathing Asbestos is hazardous to your health.
Call (702) 353-4355, David Breslitt and return to Generator if undeliverable.
CCHD Permit #ATP11-010802 Expires 4/7/2011 DAQEM Project #100633**

14. GENERATOR'S/OFFEROR'S CERTIFICATION: I hereby declare that the contents of this consignment are fully and accurately described above by the proper shipping name, and are classified, packaged, marked and labeled/placarded, and are in all respects in proper condition for transport according to applicable international and national governmental regulations.

Generator's/Offeror's Printed/Typed Name
Susan Crowley

Signature
Susan Crowley

Month Day Year

15. International Shipments Import to U.S.

Export from U.S.

Port of entry/exit:

Transporter Signature (for exports only):

Date leaving U.S.:

16. Transporter Acknowledgment of Receipt of Materials

Transporter 1 Printed/Typed Name

Signature
[Signature]

Month Day Year

Transporter 2 Printed/Typed Name

Signature
[Signature]

Month Day Year

17. Discrepancy

17a. Discrepancy Indication Space

Quantity

Type

Residue

Partial Rejection

Full Rejection

Manifest Reference Number:

17b. Alternate Facility (or Generator)

U.S. EPA ID Number

Facility's Phone:

17c. Signature of Alternate Facility (or Generator)

Month Day Year

LVPC Job Number 966525

18. Designated Facility Owner or Operator: Certification of receipt of materials covered by the manifest except as noted in Item 17a

Printed/Typed Name

Signature
[Signature]

Month Day Year

2 4 11

81 Environmental Tech
13550 N Highway 93
Las Vegas, NV 89165

Ticket Type: INBOUND INVOICE

Ticket Number: 22864
Date: 02/04/2011
Time In: 11:41 pm
Time Out: 12:00 am

Customer: 001011 - NGE, LLC c/o Northgate Environ Mgmt

Vehicle/Container: 192330
Contract: RZE ASBESTO SOIL 3825 11 0022
Comment: 3825-11-0022

Gross Weight: 79,320 LB Scale In
Tare Weight: 36,100 LB Scale Out
Net Weight: 43220 LB
Net Tons: 21.61

BOL: RZE0667

Origin	Yards	Material	Billing	Quantity
Not Applicable	0.00 YD	ASBESTOS FRIABLE	21.61	TN

Driver: 

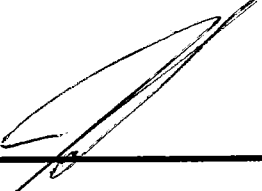
Weighmaster: 
SMITHJ

Indemnification. Customer agrees, by signature above, to indemnify, hold harmless, and defend Republic Services, Inc., its subsidiaries, affiliates, employees, officers and directors from and against any and all liabilities, claims, penalties, forfeitures, suits and the costs and expenses incident thereto, including costs of defense, settlement, and reasonable attorney's fees, which may be incurred, as a result of death or injuries to any person, or damage to any property, contamination of or adverse effects on the environment, caused in whole or in part by the Customer, its employees, or subcontractors in disposing waste at this Facility. In the event Customer delivers Unacceptable Waste (as determined by Republic) Customer agrees to assume all expenses and obligations with the removal and/or resolution of any effects caused by the delivery of such Unacceptable Waste.

Indemnización. Cliente acuerda indemnizar, mantener inmune, y defender Republic Services, Inc., sus subsidiarios, compañías, divisiones, empleados, oficiales y directores contra de cualquiera y de todas responsabilidades, demandas, penas, pérdidas, juicios, pleitos y los costos incidente además, incluyendo costos de defensa, de acuerdo judicial, y de honorarios razonables del abogado, que pueden ser incurridos en, o como resultado de, la muerte o herida personal a cualquier persona, o daños a cualquier característica, propiedad, contaminación de la tierra o efectos ilícitos en esta Facilidad, causado entero o en parte por el cliente, sus empleados, o sus subcontratistas en botar basura en esta Facilidad. En el caso que el Cliente entrega, bota, basura (según lo determinado por Republic) en este Establecimiento basura inaceptable en los reglamentos de este Establecimiento, el Cliente se compromete asumir todos los costos y obligaciones con el retiro y/o la resolución de cualquier dano(s) causado por la entrega de tal basura inaceptable.

NON-HAZARDOUS WASTE MANIFEST

1. Generator ID Number
NVD002290330

2. Page 1 of 1
3. Emergency Response Phone
(702) 353-4355

4. Waste Tracking Number
Manifest # **NZE 42667**

5. Generator's Name and Mailing Address
Tronox
P.O. Box 56
Henderson, Nevada 89009 (702) 592-7727

Generator's Site Address (if different than mailing address)
Tronox LLC
560 West Lake Mead Parkway
Henderson, Nevada 89015

Generator's Phone:
6. Transporter 1 Company Name
Las Vegas Paving Corporation NDOT #0191949

U.S. EPA ID Number
NVD986788174

7. Transporter 2 Company Name

U.S. EPA ID Number

8. Designated Facility Name and Site Address
Republic Services of Nevada
Aper, Regional Landfill (702) 423-2128

U.S. EPA ID Number

Profile Number 3825 11 0022

Facility's Phone:

9. Waste Shipping Name and Description	10. Containers		11. Total Quantity	12. Unit Wt./Vol.
	No.	Type		
1. Regulated Asbestos Containing Material Mixed with soil and construction debris		Trk	14yards	
2.			21.61	76
3.				
4.				

13. Special Handling Instructions and Additional Information
Asbestos will be wetted down and loads shall be wrapped in 6-mill visqueen. Avoid opening wrapped loads. Breathing Asbestos is hazardous to your health.
Call (702) 353-4355, David Breault and return to Generator if undeliverable.
CCHD Permit #ATP11-010802 Expires 4/7/2011 DAQEM Project #100633

14. GENERATOR'S/OFFEROR'S CERTIFICATION: I hereby declare that the contents of this consignment are fully and accurately described above by the proper shipping name, and are classified, packaged, marked and labeled/placarded, and are in all respects in proper condition for transport according to applicable international and national governmental regulations.

Generator's/Offor's Printed/Typed Name: **Susan Crowley** Signature: *S. Crowley* Month: Day: Year:

15. International Shipments Import to U.S. Export from U.S. Port of entry/exit: Date leaving U.S.:

16. Transporter Acknowledgment of Receipt of Materials
Transporter 1 Printed/Typed Name: *Bobby P...* Signature: *Bobby P...* Month: Day: Year:
Transporter 2 Printed/Typed Name: Signature: Month: Day: Year:

17. Discrepancy
17a. Discrepancy Indication Space Quantity Type Residue Partial Rejection Full Rejection

Manifest Reference Number: U.S. EPA ID Number

17b. Alternate Facility (or Generator) U.S. EPA ID Number
Facility's Phone:

17c. Signature of Alternate Facility (or Generator) Month: Day: Year:

LVPC Job Number 966525

18. Designated Facility Owner or Operator: Certification of receipt of materials covered by the manifest except as noted in Item 17a
Printed/Typed Name: **Jasi Smith** Signature: *Jasi Smith* Month: Day: Year: **2 8 11**

GENERATOR
TRANSPORTER
DESIGNATED FACILITY

81 Environmental Tech
13550 N Highway 93
Las Vegas, NV 89165

Ticket Type: INBOUND INVOICE

Ticket Number: 22865
Date: 02/04/2011
Time In: 11:44 pm
Time Out: 12:02 am

Customer: 001011 - NGE, LLC c/o Northgate Environ Mgmt

Vehicle/Container: 192346
Contract: RZE ASBESTO SOIL 3825 11 0022
Comment: 3825-11-0022

Gross Weight: 78,920 LB Scale In
Tare Weight: 36,280 LB Scale Out
Net Weight: 42640 LB
Net Tons: 21.32

BOL: RZE0668

Origin	Yards	Material	Billing	Quantity
Not Applicable	0.00 YD	ASBESTOS FRIABLE	21.32	TN

Driver:

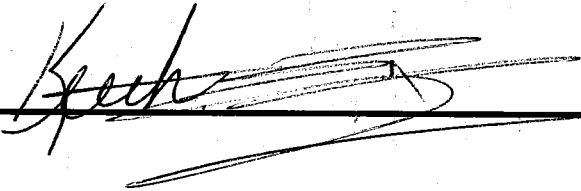

Weighmaster:

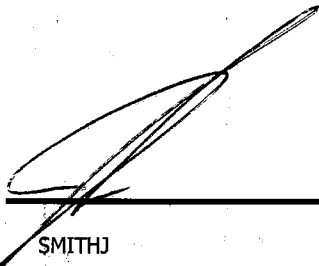

SMITHJ

Indemnification. Customer agrees, by signature above, to indemnify, hold harmless, and defend Republic Services, Inc., its subsidiaries, affiliates, employees, officers and directors from and against any and all liabilities, claims, penalties, forfeitures, suits and the costs and expenses incident thereto, including costs of defense, settlement, and reasonable attorney's fees, which may be incurred, as a result of death or injuries to any person, or damage to any property, contamination of or adverse effects on the environment, caused in whole or in part by the Customer, its employees, or subcontractors in disposing waste at this Facility. In the event Customer delivers Unacceptable Waste (as determined by Republic) Customer agrees to assume all expenses and obligations with the removal and/or resolution of any effects caused by the delivery of such Unacceptable Waste.

Indemnización. Cliente acuerda indemnizar, mantener inmune, y defender Republic Services, Inc., sus subsidiarios, compañías, divisiones, empleados, oficiales y directores contra de cualquiera y de todas responsabilidades, demandas, penas, pérdidas, juicios, pleitos y los costos incidente además, incluyendo costos de defensa, de acuerdo judicial, y de honorarios razonables del abogado, que pueden ser incurridos en, o como resultado de, la muerte o herida personal a cualquier persona, o daños a cualquier característica, propiedad, contaminación de la tierra o efectos ilícitos en esta Facilidad, causado entero o en parte por el cliente, sus empleados, o sus subcontratistas en botar basura en esta Facilidad. En el caso que el Cliente entrega, bota, basura (según lo determinado por Republic) en este Establecimiento basura inaceptable en los reglamentos de este Establecimiento, el Cliente se compromete asumir todos los costos y obligaciones con el retiro y/o la resolución de cualquier dano(s) causado por la entrega de tal basura inaceptable.

NON-HAZARDOUS WASTE MANIFEST

1. Generator ID Number
NVD008290330

2. Page 1 of
1

3. Emergency Response Phone
(702) 353-4355

4. Waste Tracking Number
Manifest # RZE #668

5. Generator's Name and Mailing Address
**Tronox
P.O. Box 55
Henderson, Nevada 89009 (702) 592-7727**

Generator's Site Address (if different than mailing address)
**Tronox LLC
560 West Lake Mead Parkway
Henderson, Nevada 89015**

6. Transporter 1 Company Name
Las Vegas Paving Corporation **NDOT #0191949**

U.S. EPA ID Number
NVD986768174

7. Transporter 2 Company Name

U.S. EPA ID Number

8. Designated Facility Name and Site Address
**Republic Services of Nevada
Apex, Regional Landfill (702) 423-2128**

U.S. EPA ID Number
Profile Number 3825 11 0022

9. Waste Shipping Name and Description

10. Containers
No. Type

11. Total Quantity

12. Unit Wt./Vol.

1. **Regulated Asbestos Containing Material
Mixed with soil and construction debris**

Trk

14yards

2.

21.32

70

3.

4.

13. Special Handling Instructions and Additional Information
**Asbestos will be wetted down and loads shall be wrapped in 6-mill visqueen. Avoid opening wrapped loads. Breathing Asbestos is hazardous to your health.
Call (702) 353-4355, David Breault and return to Generator if undeliverable.
CCHD Permit #ATP11-010802 Expires 4/7/2011 DAQEM Project #100633**

14. GENERATOR'S/OFFEROR'S CERTIFICATION: I hereby declare that the contents of this consignment are fully and accurately described above by the proper shipping name, and are classified, packaged, marked and labeled/placarded, and are in all respects in proper condition for transport according to applicable international and national governmental regulations.

Generator's/Offeror's Printed/Typed Name
Susan Crowley

Signature
Susan Crowley Month Day Year

15. International Shipments Import to U.S. Export from U.S. Port of entry/exit: _____
Transporter Signature (for exports only): _____ Date leaving U.S.: _____

16. Transporter Acknowledgment of Receipt of Materials

Transporter 1 Printed/Typed Name
Keith Sirevaag

Signature
Keith Sirevaag Month Day Year

Transporter 2 Printed/Typed Name

Signature

Month Day Year

17. Discrepancy

17a. Discrepancy Indication Space Quantity Type Residue Partial Rejection Full Rejection

17b. Alternate Facility (or Generator) Manifest Reference Number: _____ U.S. EPA ID Number

Facility's Phone: _____

17c. Signature of Alternate Facility (or Generator) Month Day Year

LVPC Job Number 966525

18. Designated Facility Owner or Operator: Certification of receipt of materials covered by the manifest except as noted in Item 17a

Printed/Typed Name
Jessie Sank

Signature
Jessie Sank Month Day Year
2 4 11

GENERATOR
INT'L
TRANSPORTER
DESIGNATED FACILITY