



**Groundwater Bioremediation Pilot Test Work Plan  
Nevada Environmental Response Trust Site  
Henderson, Nevada**

*Prepared for:*

**Nevada Environmental Response Trust**

*35 E Wacker Drive, Suite 1550  
Chicago, IL 60601*

*Prepared by:*

**Tetra Tech**

*136 E South Temple Street, Suite 910  
Salt Lake City, UT 84111*

**January 6, 2015**

**This Page Intentionally Left Blank**

## CERTIFICATION

I hereby certify that I am responsible for the services described in this document and for the preparation of this document. The services described in this document have been prepared in a manner consistent with the current standards of the profession and to the best of my knowledge comply with all applicable federal, state and local statutes, regulations, and ordinances.

**Description of Services Provided:** Groundwater Bioremediation Pilot Test Work Plan, Nevada Environmental Response Trust Site, Henderson, Nevada



---

**Steven N. Bradley, CEG**  
Deputy Program Manager  
Tetra Tech, Inc.

January 6, 2015  
Date

CEM Certificate Number: EM 1333  
CEM Expiration Date: March 22, 2015

**This Page Intentionally Left Blank**

## LIST OF ACRONYMS

AFCEE	Air Force Center for Engineering and the Environment
AQTESOLV	Aquifer Test Solver
ASTM	American Society for Testing and Materials (ASTM)
AWF	Athens Road Well Field
BAZE	Biologically Active Zone Enhancement
DO	dissolved oxygen
EOS®	emulsified oil substrate
EVO	emulsified vegetable oil
ft/day	feet per day
GWETS	groundwater extraction and treatment system
ISM	Bio-Trap® In-situ Microcosms
ITRC	Interstate Technology & Regulatory Council
IWF	Interceptor Well Field
mg/L	milligrams per liter
mL	milliliters
mV	milliVolt
NDEP	Nevada Division of Environmental Protection
NERT	Nevada Environmental Response Trust
NDWR	Nevada Division of Water Resources
ORP	oxidation-reduction potential
PLFA	phospholipid fatty acids
PRB	permeable reactive barrier
PVC	polyvinyl chloride
SWF	Seep Well Field
TDS	total dissolved solids
TOC	total organic carbon
UIC	underground injection control
UMCf	Upper Muddy Creek formation
UNLV	University of Nevada – Las Vegas
ZOI	zone of influence

**This Page Intentionally Left Blank**

## TABLE OF CONTENTS

<b>1.0 INTRODUCTION.....</b>	<b>1-1</b>
1.1 Objective.....	1-1
1.2 Work Plan Organization .....	1-2
<b>2.0 TECHNOLOGY DESCRIPTION.....</b>	<b>2-1</b>
2.1 Microbiology and Biodegradation of Perchlorate .....	2-1
2.2 Bioremediation.....	2-1
2.2.1 Bioremediation System Configurations.....	2-1
2.2.2 Carbon Substrates .....	2-3
2.3 TRUST Site Application .....	2-3
2.3.1 Bioremediation Configuration.....	2-4
2.3.2 Carbon Substrate Selection .....	2-4
<b>3.0 PRELIMINARY FIELD AND LABORATORY ACTIVITIES .....</b>	<b>3-1</b>
3.1 Field Activities.....	3-1
3.1.1 Soil Boring and Well Installation .....	3-1
3.1.2 Baseline Groundwater Sampling and Groundwater Collection .....	3-1
3.1.3 Single Borehole Dilution Testing.....	3-1
3.1.4 Slug Tests .....	3-2
3.2 Bench-Scale Studies.....	3-2
3.2.1 Laboratory Batch Microcosm Studies .....	3-3
3.2.2 Laboratory Column Studies .....	3-4
<b>4.0 PILOT TEST CONCEPTUAL DESIGN .....</b>	<b>4-1</b>
4.1 Objectives .....	4-1
4.2 Pilot Test Location .....	4-1
4.3 Conceptual Layout.....	4-2
4.3.1 Injection Well Transect.....	4-2
4.3.2 Monitoring Well Network .....	4-2
4.4 Preliminary Substrate Injection Design.....	4-3
4.4.1 Injection Protocol.....	4-3
4.4.2 Tracer Study.....	4-4
4.5 Permitting Requirements.....	4-4
4.6 Health and Safety .....	4-4
<b>5.0 EFFECTIVENESS MONITORING PLAN .....</b>	<b>5-1</b>
5.1 Tracer Study Monitoring.....	5-1
5.2 Groundwater MONITORING .....	5-1
<b>6.0 REPORTING.....</b>	<b>6-1</b>
<b>7.0 SCHEDULE .....</b>	<b>7-1</b>
<b>8.0 REFERENCES.....</b>	<b>8-1</b>

## **LIST OF TABLES**

- Table 1 Baseline Soil Sampling Protocol – Field and Homogenized Soil
- Table 2 Batch Microcosm Testing Sampling Protocol
- Table 3 Laboratory Column Testing Sampling Protocol
- Table 4 Groundwater Sampling Protocol

## **LIST OF FIGURES**

- Figure 1 Pilot Test Location
- Figure 2 Conceptual Pilot Test Layout
- Figure 3 Typical Process Flow Diagram
- Figure 4 Schedule for Groundwater Bioremediation Pilot Test



## 1.0 INTRODUCTION

On behalf of the Nevada Environmental Response Trust (NERT), Tetra Tech, Inc. (Tetra Tech) has prepared this Groundwater Bioremediation Pilot Test Work Plan (Work Plan) for the NERT site, located in Clark County, Nevada (Trust Site) (Figure 1). This Work Plan is being submitted to the Nevada Division of Environmental Protection (NDEP) to revise the previously submitted *Treatability Study Work Plan, Permeable Reactive Barrier Pilot, Revision 2* (ENVIRON, 2014a), and as part of the Remedial Investigation/Feasibility Study for the Trust Site, pursuant to the Interim Consent Agreement effective February 14, 2011.

This revised Work Plan presents an updated technical approach and scope of work for the bench-scale and pilot-scale tests. The following are the salient differences between the previous work plan and the revised approach described in this work plan:

- Tetra Tech's approach is to examine the feasibility of bioremediation as a biologically active zone enhancement process (BAZE), rather than testing the specific permeable reactive barrier (PRB) concept, which by definition, often presumes that significant treatment occurs within the barrier itself. Tetra Tech's pilot test is designed to examine the potential for prolonged perchlorate treatment in groundwater via the creation of a long-term biologically reducing zone in groundwater.
- Tetra Tech's approach does not include Bio-Trap<sup>®</sup> In-situ Microcosms (ISMs) as the first field phase prior to the actual pilot test. Based on our review of the objectives of bioremediation, Trust Site characteristics, in-house experience and expertise, and consultation with the ISM vendor (Microbial Insights in Rockford, Tennessee), Tetra Tech will instead incorporate strategic Bio-Traps<sup>®</sup> in select wells in the groundwater monitoring and evaluation process *as part of* the actual field pilot test.
- Tetra Tech is proposing to perform a short-term batch microcosm study, in addition to the column studies proposed in the previous plan, to obtain key data and information. Both tests will be performed by the University of Nevada at Las Vegas (UNLV).
- Tetra Tech has performed a review of the available carbon substrates that are currently used for perchlorate bioremediation and evaluated the most appropriate substrate for the Trust Site, so additional substrate evaluation is not included as part of the pilot test.
- Tetra Tech has also evaluated the engineering configurations that are typically used for bioremediation and, based on Trust Site characteristics, recommended the employment of a well transect system for the pilot test to create the BAZE system, rather than a continuous PRB.

Background information on the Trust Site, including regulatory status, previous studies, physical setting, geology, hydrogeology, and contaminant distribution, is provided in the previous submittal (ENVIRON, 2014a).

### 1.1 OBJECTIVE

The overall objective of this pilot test is to evaluate the feasibility of using bioremediation installed in a well transect configuration as a remedial technology for creation of a BAZE system for treatment of perchlorate-contaminated groundwater that has migrated off-site from the Trust Site. At the current time, groundwater is being extracted from three separate locations: the on-site Interceptor Well Field (IWF), the off-site Athens Road Well Field (AWF), and the off-site Seep Well Field (SWF). The groundwater is then being treated in an aboveground extraction and treatment system (GWETS) located on-site using fluidized bed bioreactors. If bioremediation is

demonstrated to be a successful treatment technology through this pilot test, a feasibility study can be performed to examine if its' large-scale application can reduce costs and treatment timeframe to less than the aboveground treatment system. Additionally, bioremediation could also be considered and utilized for on-site treatment of groundwater. On-site bioremediation of groundwater could be performed in tandem with the GWETS, in a reduced capacity, to reduce overall long-term costs and to curtail continuing perchlorate migration. The results and findings from a second pilot test for the vadose zone (which is currently being planned for treatment of vadose zone perchlorate contamination via soil flushing and bioremediation [Tetra Tech, 2014]) would also be incorporated into the feasibility study to compare the costs and benefits of larger-scale in situ treatment vs. the current groundwater extraction and aboveground treatment, and to arrive at the most prudent long-term remediation strategy. To date, bioremediation has not been evaluated on a field-scale at the Trust Site; therefore the proposed pilot test will be the first application of the technology.

## 1.2 WORK PLAN ORGANIZATION

This Revised Work Plan is organized as follows:

- **Introduction (Section 1):** Describes the primary objectives of the pilot test and organization of this work plan.
- **Technology Description (Section 2.0):** Provides an overview of perchlorate bioremediation and briefly describes application of the technology to the Trust Site.
- **Preliminary Field and Laboratory Activities (Section 3.0):** Provides a description of the field activities and laboratory studies to be completed prior to the pilot test to optimize and finalize its design. Details of the laboratory studies provided herein include the objectives, set-up, effectiveness monitoring, and evaluation of results.
- **Pilot Test Conceptual Design (Section 4.0):** Describes the conceptual design of the pilot test, including objectives, test location, conceptual layout, preliminary substrate injection design, permitting requirements, and health and safety.
- **Effectiveness Monitoring Plan (Section 5.0):** Presents the conceptual effectiveness monitoring program for the pilot test, including the tracer study and field, analytical, and microbial groundwater monitoring.
- **Reporting (Section 6.0):** Summarizes reporting related to design and execution of the preliminary field and laboratory activities and pilot test.
- **Schedule (Section 7.0):** Summarizes the schedule for conducting the preliminary field activities, pilot test, and associated reporting.
- **References (Section 8.0):** Lists the documents referenced in this Work Plan.

## **2.0 TECHNOLOGY DESCRIPTION**

The following subsections briefly describe the perchlorate biodegradation process, bioremediation as a treatment technology, and its' application as related to the Trust Site.

### **2.1 Microbiology and Biodegradation of Perchlorate**

Perchlorate is the anionic moiety of ammonium perchlorate, a common component of solid rocket fuel. Perchlorate salts are very soluble in water (approximately 200,000 milligrams per liter [mg/L] for ammonium perchlorate and approximately 2,100,000 mg/L for sodium perchlorate), do not adsorb very strongly to most soils, and are not amenable to chemical oxidation.

Perchlorate tends to be biologically stable under aerobic conditions or when there is a limited source of organic carbon. However, in the presence of a continuing carbon source and after dissolved oxygen (DO) and nitrate have been depleted, perchlorate can act as an electron acceptor for anaerobic respiration. The first step in perchlorate biodegradation is carried out by the enzyme perchlorate reductase, wherein perchlorate is sequentially converted to chlorate and then to chlorite. A second enzyme, chlorite dismutase further reduces the chlorite to chloride and oxygen (Interstate Technology & Regulatory Council [ITRC], 2008).

A variety of perchlorate-reducing bacteria have been isolated, with some of them being strict anaerobes, while others are facultative microbes. Generally, perchlorate reducing microorganisms are known to be quite ubiquitous in the subsurface and are also quite versatile. As a result, the key to successful groundwater treatment is understanding the chemical, geochemical, physical, geological, and hydrogeological conditions at a site, and then devising a prudent approach to engineer a successful remedial strategy. Physical, geological, and hydrogeological conditions are commonly quite established and fixed, and therefore, a successful remedial strategy relies on the alteration and sustainment of the appropriate geochemical conditions for continual perchlorate biodegradation to occur. Favorable redox conditions that are appropriate for perchlorate biodegradation are less than 0 millivolts (mVs) and generally in the 0 to -100 mVs range. This range of redox is generally indicative of conditions wherein the aquifer is depleted of DO and nitrate itself gets consumed, leaving perchlorate the next preferred electron acceptor as the respiratory source for native microorganisms (ITRC, 2008).

### **2.2 BIOREMEDIATION**

In aquifers that are aerobic or have a limited supply of natural organic carbon, the key to successfully attaining and sustaining the appropriate redox range is to add a carbon electron donor/substrate to the subsurface. Numerous carbon donors are available and the choice at a given site is based on several physical, chemical, geochemical, and economic factors. At the Trust Site, the objective is to examine the feasibility of bioremediation, which requires the engineered addition of a carbon substrate to the groundwater to optimize and sustain in situ biodegradation of perchlorate in groundwater. All reduction occurs in situ and, as previously described, is carried out by native microorganisms which possess the enzymatic ability to completely reduce perchlorate to chloride and oxygen.

#### **2.2.1 Bioremediation System Configurations**

The addition of carbon substrate can be performed via a variety of engineering configurations. The selection of the optimal configuration at a particular site depends on several factors including the nature and extent of the perchlorate plume and whether the application is for source area treatment, large/long plumes, or plume containment/boundary treatment. Mechanisms and

conduits for the addition of a carbon substrate can also vary in the form of permanent injection wells, direct push injection points, or continuous barriers. Another set-up that has been successfully employed is the creation of in situ anaerobic bioreactors installed in strategic areas of the groundwater plume to treat perchlorate contamination (Air Force Center for Engineering and the Environment [AFCEE], 2008). In some cases, groundwater recirculation can also be an option to optimize the consumption of the carbon substrate, enhance kinetics of perchlorate biodegradation, and decrease overall remedial timeframes. Each of these configurations and systems has its own advantages and limitations, which need to be considered for an individual site prior to implementation (AFCEE, 2004). The following briefly details three basic configurations:

- **Transect Systems:** Transect systems involve the installation of permanent injection wells that are installed along selected transects at a designed spacing perpendicular to groundwater. The injection of carbon substrate into the wells along the transect creates a downgradient biologically reducing zone also known as BAZE (ESTCP, 2010). Transects in the form of direct push points, or if feasible, a continuous trench, also known as a biowall or a biobarrier, are alternatives to injection wells. Groundwater injection transects are generally perpendicular to groundwater flow. The objective is to create a long-term biologically reducing zone to treat perchlorate in groundwater at strategic locations within groundwater plumes using one or more transects.
- **Grid Systems:** When larger plumes require treatment, bioremediation can be performed in the form of injection points that are arranged in a grid within the targeted treatment area. This configuration could contain permanent injection wells, direct push points, or a combination of these two delivery methods. The design and spacing of a grid system depends on the zone of influence of the carbon substrate; the perchlorate treatment that can be achieved in the particular geological setting; and on other physical, geochemical, and economic factors.
- **Combination of Transects and Grid Patterns:** In the case of large plumes, a combination of the transect arrangement and a grid pattern can be installed to effect the desired objectives of targeting areas of higher contamination at strategic locations within the plume, as well as preventing further perchlorate migration beyond defined strategic locations or compliance points.

Depending on the feasibility, economics, site-specific features, and perchlorate biodegradation potential, large plumes are often treated with a series of strategically installed transects oriented perpendicular to the direction of groundwater flow to economically and efficiently treat substantial areas of the plume. Depending on site conditions and objectives, recirculation of groundwater in a range of patterns has been used at some sites to benefit overall carbon distribution and treat groundwater more completely and efficiently within given areas. However, as described in recent reports (ENVIRON, 2014a), continuous groundwater recirculation that was performed over long periods of time at the adjacent American Pacific Corporation site resulted in biofouling and reduction in hydraulic flow rates. Therefore, while groundwater recirculation has its benefits, its implementation should be strategically evaluated and planned to avoid long-term hydraulic issues. Lessons learned from adjacent bioremediation efforts, judicious selection of the carbon substrate, and employment of oxygen scavengers should be considered if recirculation is a component of overall treatment.

## 2.2.2 Carbon Substrates

Organic carbon substrates that have been typically used to treat perchlorate in groundwater can be subdivided into three general groups:

- **Water-soluble substrates:** These materials dissolve completely in water, and are transported with groundwater in the subsurface. It is typically necessary to add these substrate types in designed amounts to the aquifer either continually or in bulk (slug) quantities over relatively short time intervals. Examples include alcohols (ethanol or methanol), glycerin, sugars (molasses or high-fructose corn syrup), and soluble salts (sodium acetate or sodium lactate). The advantage of soluble substrates is the ease of delivery, handling, and storage. However, they also typically have shorter half-lives and, over a longer timeframe, could cause biofouling in the aquifer.
- **Slow-release substrates:** These materials include a variety of relatively water-insoluble substances that are typically relatively slow-moving in the subsurface. These materials remain in the area where injected for a longer period, and provide a controlled, slow release of organic carbon into the environment. Examples include emulsified vegetable oil (EVO) provided as Emulsified Oil Substrate [EOS<sup>®</sup>] (EOS<sup>®</sup> Remediation, LLC), Newman Zone (Remediation and Natural Attenuation Services, Inc.), Lactoil (JRW Bioremediation Products, Inc.), and Hydrogen Releasing Compound (Regenesis Bioremediation Products, Inc.). The major advantage of these substrates is their longevity in the subsurface, less frequent injection intervals, and less likelihood of biofouling.
- **Solid substrates:** These materials include agricultural materials such as mulch, compost, or wood chips. These materials are commonly placed, along with gravel, within a designed continuous biowall or biobarrier. Natural solid substrates are often economical, available in many parts of the country, safe to handle, and generally last for longer time periods. However, such substrates are generally only applicable to continuous biowalls and cannot be directly added to conventional injection wells.

All three types of substrates discussed above have been successfully employed at major perchlorate sites across the country to treat groundwater (ITRC, 2008). The choice of a particular substrate depends on a host of physical, chemical, geochemical, and hydrogeological factors as well as the engineering configuration that has been selected for at the particular site.

## 2.3 TRUST SITE APPLICATION

The microbiology and biodegradation of perchlorate, engineering mechanisms, and type of carbon substrates were considered prior to arriving at the appropriate pilot testing strategy for the Trust Site. The two key specific factors that were evaluated are the known geological and hydrogeological characteristics (lithology and groundwater velocity) and depth to groundwater at different locations. In addition, previous work plans and reviews of bioremediation approaches for the Trust Site have also been taken into consideration (ENVIRON, 2014a; Shaw, 2010; Northgate, 2010).

The most recently recommended bioremediation approach identified a PRB to be examined in the field after completion of preliminary field testing using ISMs and laboratory column studies (ENVIRON, 2014a). A suitable area located off-site and approximately 2,000 feet downgradient of the AWF, in the vicinity of existing groundwater wells PC-98R and MW-K5, was selected for

the field pilot PRB test. Tetra Tech is proposing to perform the pilot test described in this work plan at the same location.

### **2.3.1 Bioremediation Configuration**

Tetra Tech has reviewed boring logs for monitoring wells PC-98R and MW-K5, the lithology in the area, the geological cross-sections in the area, and known hydrogeological characteristics such as groundwater velocity that have been previously reported (ENVIRON, 2014a). The total well depths recorded in wells PC-98R and MK-4 were 43.5 and 40.5 feet, respectively. Geological cross-sections indicate that the depth of a proposed PRB at this location could be greater than 40 feet to treat the targeted saturated zone. At these depths, continuous PRBs could be cost-prohibitive and infeasible for pilot testing purposes. The cross-sections also indicate a wide variation in depth to the Upper Muddy Creek formation (UMCf) across the plume, which could make the construction of a continuous PRB cumbersome. AFCEE's protocol for PRBs lists the depths of over 20 continuous PRBs, with the shallowest at less than 25 feet, and the greatest depth at 37 feet, at which extensive and cumbersome benching was required for construction (AFCEE, 2008). Groundwater velocities in the pilot test area have also been reported at rates ranging from 15 feet per day (ft/day) (ENVIRON, 2014a) to 2-3 ft/day (ENVIRON, 2013). At these higher groundwater velocities, a PRB serves more as a vehicle/conduit for carbon substrate delivery to the subsurface followed by downgradient perchlorate biodegradation, rather than as a conventional "treatment barrier."

For the off-site location proposed by ENVIRON, an alternative and more prudent approach to PRBs from a previous plan recommended using separate injection points spaced along a transect at the same location (Shaw, 2010). Tetra Tech also recommends this feasible option of installing individual injection wells at a designed spacing along a single transect perpendicular to groundwater flow for pilot testing. The saturated soil lithological characteristics in the selected pilot test location (discussed in Section 4.2) are generally silty sand/gravel/sandy gravel, which will make it conducive to inject carbon substrate fluids through individual wells spaced along a transect. Individual wells are also useful if follow-up substrate injections are required to sustain reducing conditions for the continued biological reduction of perchlorate.

### **2.3.2 Carbon Substrate Selection**

The second important consideration for the proposed pilot study is the choice of substrate. As previously described, each type of substrate has its benefits and limitations. Because the pilot test will be performed on a well-based transect, the use of natural or agricultural slow-release substrates such as compost or mulch, which are of great potential in a continuous PRB, would not be feasible for this pilot test. Secondly, a previously published laboratory study showed that compost was not the optimal choice to biodegrade perchlorate in groundwater at the Trust Site (Perlmutter, Britto et al., 2000). Synthetic soluble substrates or salts, such as fructose or acetate, have shorter half-lives and would have to be injected much more frequently into the wells, and could cause secondary issues such as biofouling. The same study concluded that the use of a soluble substrate is unlikely to create an extended bioreactive zone much beyond the point of injection, making it infeasible for the treatment of long plumes (Perlmutter, Britto et al., 2000).

Therefore, it is Tetra Tech's belief that the most appropriate choice of carbon substrate is a slow-release synthetic substrate in the form of EVO. EVO has the ability to induce biodegradation of perchlorate rapidly, while also enabling its transport and long-term sustenance downgradient of the injection well transect (AFCEE, 2007). Two previous plans/studies highlighted the application of EVO for groundwater biotreatment of perchlorate at the Trust Site. The first was a work plan

that recommended EVO in the form of EOS<sup>®</sup> (EOS<sup>®</sup> Remediation) (Shaw, 2010). The second was a bench-scale jar test that employed emulsified oil from EOS<sup>®</sup> Remediation and concluded that their substrate had the required soil-retention ability as well as adequate perchlorate biodegradation potential (Northgate, 2010). In an aquifer with high groundwater velocities such as the Trust Site, an EVO product with a higher soil-retention capacity is desirable. One such product is EOS<sup>®</sup> 100, which has been tested and compared to other EOS<sup>®</sup> products and has been shown to have twice the retention capacity in coarse grained sediments (Elkins, Borden et al., 2014). Tetra Tech is proposing to use EOS<sup>®</sup> 100 for both laboratory and pilot tests described in Sections 3.2 and 4.0, respectively. Because this product results in gradual release of carbon substrate over time, it also minimizes biofouling in the aquifer. The longevity attributed to this product also means that continuous recirculation (which is sometimes required with soluble substrates and was a method employed at the AMPAC site) is not required, thereby further minimizing the potential for biofouling.

**This Page Intentionally Left Blank**



### **3.0 PRELIMINARY FIELD AND LABORATORY ACTIVITIES**

This section describes the various preliminary activities to be completed prior to the pilot test, including several field activities and a series of bench-scale studies. Results from these tasks will be used to finalize design details for pilot test implementation.

#### **3.1 FIELD ACTIVITIES**

All field work described herein will be conducted in accordance with the existing Site Management Plan (ENVIRON, 2012) and Field Sampling Plan (ENVIRON, 2014b). Following approval of this Work Plan by NDEP and prior to any field activities, Tetra Tech, on behalf of NERT, will acquire access and legal use agreements for installation, injection, and monitoring from the City of Henderson, who is the property owner where the pilot test will be performed. Tetra Tech, on behalf of NERT, will also prepare and submit all required applications for permitting prior to the installation of the soil boring/monitoring well. Once approval is granted, an underground utility survey will be performed before drilling commences. The monitoring well will be drilled in accordance with the Nevada Division of Water Resources (NDWR) requirements, following submittal of a notice of intent to drill.

##### **3.1.1 Soil Boring and Well Installation**

One soil boring will be drilled within the vicinity of the proposed pilot test location depicted in Figure 2. The soil boring will be drilled through the alluvium to a depth that corresponds to the top of the UMCf. Soil collected from the boring will be shipped to UNLV for use in the laboratory bench-scale studies described in Section 3.2. Soil samples will also be collected and sent for chemical and microbial laboratory analysis for parameters listed in Table 1. Physical parameters that will be evaluated include moisture content, porosity, and soil density.

The boring will be converted to a permanent monitoring well, which will be screened across the saturated alluvium and terminated at the top of the UMCf, resulting in an approximate screen length of 25 feet, or length that is deemed appropriate and required at this location. The well will be constructed using 4-inch schedule 40 polyvinyl chloride (PVC) casing and screened with 4-inch diameter slotted PVC.

##### **3.1.2 Baseline Groundwater Sampling and Groundwater Collection**

Two monitoring wells, MW-K5 and PC-98R, are located within the general pilot test location (described in further detail in Section 4.3). These existing monitoring wells and the new monitoring well described in Section 3.1.1 will be used for baseline sampling of groundwater. To establish baseline conditions of the groundwater to be used in the bench-scale studies, groundwater will be sampled and analyzed for a variety of field and laboratory parameters, which are described in more detail in Section 5.2. Once the required quantity of groundwater has been collected from the three wells, it will be transported to UNLV to be used in the bench-scale studies described in Section 3.2.

##### **3.1.3 Single Borehole Dilution Testing**

A single-borehole dilution test will be performed in the newly installed well to evaluate volumetric flow in the pilot test area. Single-borehole dilution tests consist of mixing a tracer compound into the groundwater in a well, and then observing the decline in tracer concentration in the well as a function of time using downhole instruments (e.g., Pitrak et al., 2007). The decline in tracer

concentration in the well is due to dilution by volumetric groundwater flow, and the results will be used to estimate groundwater velocity in the immediate vicinity of the well.

Tracers used in single-borehole dilution tests are typically chloride or bromide salts, or fluorescent dyes. Based on the proximity of the test area to the Las Vegas Wash, the use of fluorescent dye tracers is not recommended. Furthermore, water quality results summarized in the previous Work Plan (ENVIRON, 2014a) indicate that groundwater near the proposed pilot test location has a specific conductance of 12,300 to 13,500 microsiemens per centimeter, suggesting that analytical interferences may be a problem if salt tracers are used in conjunction with conventional ion-specific electrodes for concentration measurement. Water samples collected after well installation will therefore be analyzed for major cations and anions, and tests will be performed to evaluate potential analytical interferences for typical salt tracers, such as bromide. If analytical interferences prevent the use of salt tracers, deionized water may be used as a tracer for the borehole dilution tests. The application of deionized water will also be examined in the laboratory prior to its application in the field.

Results of the single borehole dilution test will be used to determine appropriate flow rates for bench-scale column testing and design of the field pilot test. All results will be provided in a technical memorandum, which is further described in Section 6.0.

### **3.1.4 Slug Tests**

Slug tests will be performed in existing monitoring wells MW-K5 and PC-98R and in the newly installed monitoring well described in Section 3.1.1 to estimate aquifer hydraulic conductivity in the pilot test area and to confirm the results of the borehole dilution test described in Section 3.1.3. The slug tests will be performed in general accordance with American Society for Testing and Materials (ASTM) Standard D4044-96 (ASTM International, 2008). Prior to conducting each slug test, the water level in the well will be measured manually with an electronic water level sounder to determine the static groundwater level. An electronic pressure transducer/datalogger will then be suspended in the well, and water levels will be monitored manually until static conditions are reestablished. A falling-head test will then be conducted by smoothly lowering a length of weighted PVC pipe into the well and securing it in place above the transducer, and recording the rate of water level recovery. Once static conditions are reestablished, a rising-head test will be conducted by removing the slug and allowing the water level to again recover to static conditions while recording the rate of recovery. Barometric pressure changes during testing will be monitored and recorded using a pressure transducer placed above the water table.

At the end of each test, the pressure transducer will be removed from the well, and the water level displacement data will be downloaded to a laptop computer and corrected for barometric pressure effects. The corrected data will be interpreted using Aquifer Test Solver (AQTESOLV) (Duffield, 2014), or similar aquifer test analysis software. If possible, both the falling-head and rising-head data will be analyzed to cross-check the interpretation results.

## **3.2 BENCH-SCALE STUDIES**

Two types of bench-scale studies, batch microcosm and column, are proposed to be performed at UNLV as part of preliminary activities. Procedures, analytical methods, and a detailed scope of work will be formalized with UNLV personnel prior to performing the studies.

### **3.2.1 Laboratory Batch Microcosm Studies**

The purpose of the laboratory batch microcosm studies is to evaluate perchlorate biodegradation characteristics for use in the field pilot test. As discussed in Section 2.3.2, EOS<sup>®</sup> 100 from EOS<sup>®</sup> Remediation has been proposed as the carbon substrate. The following subsections briefly outline the objectives and general scope of the laboratory batch microcosm studies.

#### **3.2.1.1 Objectives**

The objectives of the batch soil microcosm testing are to accomplish the following:

- Evaluate carbon EOS<sup>®</sup> 100 dosage effects on perchlorate biodegradation;
- Measure the lag time for inducing of perchlorate biodegradation;
- Determine the kinetics of perchlorate biodegradation;
- Assess the need for micronutrients (nitrogen and phosphorus); and
- Evaluate the effects of soil pH on the biodegradation of perchlorate.

#### **3.2.1.2 Soil and Groundwater Testing**

Soil collected from the boring discussed in Section 3.1.1 will be used in the laboratory bench-scale studies. The soil will be homogenized and analyzed for the parameters listed in Table 1. The objectives of measuring each of these parameters are also listed in Table 1. Additional parameters will be determined, including soil physical properties such as native soil moisture content, porosity, and soil density.

Groundwater will be collected from the newly installed monitoring well (described in Section 3.1.1), or existing monitoring wells MW-K5 and PC-98R (described in Section 3.1.2) for use in the laboratory bench-scale studies. Baseline groundwater sampling is further described in Section 5.2.

#### **3.2.1.3 Microcosm Set-up and Testing**

Batch microcosm testing is expected to last over a period of 2 to 3 weeks. Typically, batch microcosm tests will be performed in 250-milliliters (mL) microcosm bottles. Groundwater will be added to the microcosm in a soil/groundwater ratio of 1:4 (weight-to-weight) in the 250 mL glass serum bottles with a minimal headspace. The bottle headspace will be purged with nitrogen prior to sealing them with air-tight septum caps, which will allow for withdrawal of solution from the bottle. The microcosms will be mixed by inversion three times per day to promote mixing of the aquifer solids with the groundwater. Three different dosages of EOS<sup>®</sup> 100 will be examined. An additional set of microcosms will also be amended with micronutrients to evaluate their need in perchlorate degradation of groundwater. All amended and control microcosms will be run in triplicate and incubated at room temperature.

Water samples will be periodically withdrawn from the microcosms using a syringe and filter (0.45 micrometer pore size). Water samples will be analyzed for parameters presented in Table 2 (which also lists the methods and purpose of analyses) at time (t) = 0 (immediately following addition of amendments) and at three to four additional time points during the course of the test. Once microcosm testing is complete, the soil will be analyzed for phospholipid fatty acids (PLFA) and the perchlorate reductase gene.

### **3.2.1.4 Evaluation of Results**

All results will be tabulated, graphed (as required), evaluated for the objectives listed in 3.2.1.1, and used to assist in the design of the laboratory column studies (described in Section 3.2.2). Results will be presented in a technical memorandum, which will describe how these results will be used to finalize the design and implementation of the field pilot test.

## **3.2.2 Laboratory Column Studies**

Column studies will be performed using the optimal dosage of EOS® 100 identified in the microcosm batch tests. Column studies will be used to examine the effectiveness of bioremediation of perchlorate in a flow-through mode that most closely simulates field conditions in the immediate vicinity of carbon substrate injected into a well along a transect. Column studies will be performed following completion of the batch microcosm studies. The following subsections briefly outline the objectives and general scope of the laboratory column studies.

### **3.2.2.1 Objectives**

The objectives of the column studies are to accomplish the following:

- Evaluate the degradation performance of the selected substrate in a flow-through condition;
- Assess the effect of flow rate (approach velocity) on perchlorate biodegradation;
- Examine or extrapolate the longevity of the carbon substrates at these flow rates;
- Determine the need for additional supplementation of the carbon substrate;
- Examine if biofouling is occurring in the column via hydraulic conductivity testing;
- Assess the potential for metals mobilization under anaerobic (reducing) conditions; and
- Preliminarily examine the need for recirculation as part of overall treatment.

### **3.2.2.2 Column Set-Up**

ASTM Test Method D4874-95 (Standard Test Method for Leaching Solid Material in a Column Apparatus) will be used as a general guide for the column tests. The method is a standard laboratory procedure for generating aqueous leachate from materials using a column apparatus. The method provides for the passage of an aqueous fluid through materials of known mass in a saturated upflow mode. Analysis of column effluent provides information on the leaching characteristics of material under the conditions used in the test. It is intended that the sample used in the procedure be physically, chemically, and biologically representative of the material from the Trust Site.

Column tests will be performed in columns that are 5 feet in length and 2 inches in diameter with sampling ports located along the column length. A designed dosage of EOS® 100 carbon substrate will be thoroughly mixed into the soil that was obtained from the newly installed monitoring well (described in Section 3.1.1). The soil in the column will be packed in a fashion such that properties such as density, moisture content, and other hydraulic properties are as close as possible to those in the field in order to simulate in-situ conditions. One unamended column will also be constructed to be used as a control. The hydraulic conductivity of the columns will be tested using the falling head permeameter test. Columns will be first saturated by pumping

groundwater in the upflow mode to let the pore gases escape. Following saturation, water will be introduced into the columns at two designated flow rates to be determined based on the results of borehole dilution testing described in Section 3.1.4. The water to be used for the column for the entire duration of the column test will be from the two existing wells (MW-K5 and PC-98R) and the newly constructed monitoring well in the pilot test vicinity.

### **3.2.2.3 Effectiveness Monitoring**

Water samples will be collected periodically from both the effluent and various sampling ports located along the length of the column for the parameters listed in Table 3, which includes the methods and the objectives for each analyte. The need for additional EOS<sup>®</sup> 100 in the influent groundwater will be determined based on the perchlorate concentrations and other analytical measurements, such as oxidation-reduction potential (ORP) and total organic carbon (TOC), from the various sampling ports and effluent. Column tests are expected to last for 12 weeks, but could be extended up to a period of 16 weeks, depending on the results of periodic effluent sampling. At closure of the column studies, hydraulic conductivity will be measured using the falling head permeameter test, and soil samples will be collected and analyzed for PLFA and the perchlorate reductase gene.

### **3.2.2.4 Evaluation of Results**

All results will be tabulated and graphed, as required, and evaluated for the objectives listed in Section 3.2.2.1. Data and information gathered during the column studies will be used to modify pilot testing, as needed. Results will be presented in the Final Pilot Test Results Report, described in Section 6.0.

**This Page Intentionally Left Blank**

## 4.0 PILOT TEST CONCEPTUAL DESIGN

This section describes the conceptual design for the proposed pilot test. The conceptual design includes objectives, pilot test location, conceptual well layout, preliminary substrate design, permitting requirements, and health and safety requirements. The pilot test design, as well as the effectiveness monitoring program (described in Section 4), may be modified or refined based on the results of additional data collection (described in Section 3.0). The final details of the pilot test design will be presented in a technical memorandum presented as an amendment to this work plan that will also summarize the results of the pre-investigation activities and the results of the batch microcosm studies. The pilot test is expected to be of six-month duration.

### 4.1 OBJECTIVES

The objectives of the proposed pilot test are to accomplish the following:

- Demonstrate the feasibility of bioremediation to remediate perchlorate-contaminated groundwater;
- Estimate the zone of influence (ZOI) achieved in the subsurface during the pilot test;
- Evaluate the kinetics of contaminant degradation;
- Estimate or extrapolate the longevity of the carbon substrate and the frequency of substrate replenishment, if required, to prevent perchlorate breakthrough immediately downgradient of the transect;
- Examine the approach for full-scale transect or grid treatment including equipment, injection, and monitoring well layout; substrate addition and replenishment; and analytical sampling evaluation criteria; and
- Estimate preliminary treatment timeframes and preliminary costs for full-scale implementation if the pilot test shows that bioremediation is effective.

### 4.2 PILOT TEST LOCATION

The proposed area for the pilot test is approximately 2,000 feet downgradient of the AWF, midway between the AWF and SWF, as shown in Figure 2, which is the same area that was selected in the previous work plan (ENVIRON, 2014a). This was also the location selected by previous consultants/contractors, Shaw Environmental, Inc. and Northgate Environmental Management, Inc. (Shaw, 2010; Northgate, 2010). Tetra Tech concurs with the assessment and selection of this location, which was chosen for the following reasons, according to the 2014 ENVIRON plan:

- Location is a significant distance from existing extraction well fields;
- Pilot test area is within the paleochannels in the UMCf, which appear to influence the direction of groundwater flow and transport of perchlorate from the Trust Site to the Las Vegas Wash;
- Perchlorate concentrations are greater than 10 mg/L, which will offer easy observation of remedy effectiveness;
- The Las Vegas Wash is located a sufficient distance downgradient of the test area, which will allow for monitoring of degradation by-products, dissolution/release of compounds that may adversely affect water quality, and unconsumed substrate; and

- No structures or other factors (such as drainage) are present within the vicinity of the proposed pilot test area.

### 4.3 CONCEPTUAL LAYOUT

As explained in Section 2.3.1, the most viable mechanism for bioremediation testing and application at the Trust Site would be its implementation in a well transect configuration to create a long-term biologically reducing zone. This section describes the details of the injection well transect and downgradient effectiveness monitoring well network that will be installed to evaluate the technology. The conceptual layout and injection and monitoring well locations are provided in Figure 2. Tetra Tech, on behalf of NERT, will prepare and submit all required applications for permitting and access prior to the installation of injection and monitoring wells. Once approval is granted, an underground utility survey will be performed before drilling commences. All wells will be drilled in accordance with the NDWR requirements. Drilling, well installation, and well development procedures are provided in the *Field Sampling Plan, Revision 1* (ENVIRON, 2014b).

#### 4.3.1 Injection Well Transect

The location and number of injection wells needed for completion of the pilot test was based on the anticipated effective lateral and longitudinal zone of influence (ZOI) using this remedial technology. As a result, a total of four injection wells, spaced approximately 50 feet apart, will be installed in a single transect located perpendicular to groundwater flow to intersect perchlorate-contaminated groundwater. Based on the hydrogeological characteristics and higher permeability in the alluvium, it is estimated that 25 feet is a likely lateral influence that can be expected with a sufficient degree of overlap and factor of safety for carbon distribution in groundwater (AFCEE, 2004). The transect will be located immediately downgradient of the two existing monitoring wells MW-K5 and PC-98R and the newly installed well (described in Section 3.1.1), which will serve as upgradient wells. This number of injection wells (four for this transect) should be sufficient to take into account subsurface variability in the vicinity as well as general effectiveness of bioremediation at remediating perchlorate-contaminated groundwater. An additional tool, a two-dimensional transport model, such as the PRINCE model (Princeton Analytical Models suite) or equivalent, will also be employed to examine the lateral and longitudinal spatial and temporal coverage that can be achieved with this spacing by performing iterative computational simulations (Wilson and Miller, 1978). The exact spacing of the injection wells will be finalized based on the results of the slug tests and single borehole dilution testing, geological characteristics in the area, soil analyses, and groundwater modeling results.

Each injection well will be screened across the saturated alluvium and terminated at the top of the UMCf, resulting in an approximate screen length of 25 feet, or an appropriate screen length that is determined to be required at each location. Wells will be constructed using 2-inch schedule 40 PVC casing and screened with 2-inch diameter slotted PVC.

#### 4.3.2 Monitoring Well Network

A monitoring well network, consisting of both upgradient and downgradient monitoring wells will be required to determine pilot test effectiveness. Two existing wells, MW-K5 and PC-98R, and the newly installed well (described in Section 3.1.1), will be used as the upgradient monitoring wells to determine the perchlorate concentrations in groundwater that are migrating into the injection well transect.



Monitoring wells will be strategically installed at designated locations downgradient of the injection well transect to monitor for treatment effectiveness. A total of 12 monitoring wells will be installed. The monitoring well layout and its relation to the injection well transect is presented in Figure 2. Eleven of the monitoring wells will be at locations directly in-line and offset from the injection wells at distances of 5, 10, 30, 50, 100, and 200 feet downgradient of the transect. Tetra Tech's pilot study should have minimal/negligible impact side-gradient and more impact in the downgradient direction, which will be sufficiently distant from the effluent ponds (located in the Henderson Bird Viewing Preserve and also referred to as "Birding Ponds") in the vicinity. However, a monitoring well will be installed immediately adjacent to the effluent pond as shown in Figure 2 for monitoring purposes. The exact number and location of effectiveness monitoring wells may be modified based on the results of the slug tests and the single borehole test, estimations of groundwater velocity, and other geological characteristics in the area, and will be detailed in the technical memorandum prepared at the beginning of the field pilot testing phase.

Each monitoring well will be screened across the saturated alluvium and terminated at the top of the UMCf, resulting in an approximate screen length of 25 feet, or an appropriate screen length that is determined to be required at each location. Wells will be constructed using 2-inch schedule 40 PVC casing and screened with 2-inch diameter slotted PVC.

## **4.4 PRELIMINARY SUBSTRATE INJECTION DESIGN**

### **4.4.1 Injection Protocol**

The quantity of substrate that will be injected into the transect wells at the beginning of the pilot test will be based on the results of the microcosms tests, the known chemistry and geochemistry of the groundwater, stoichiometric requirements for the EOS<sup>®</sup> 100, mass of perchlorate and other electron acceptors that will migrate through the transect in the pilot test timeframe, and EOS<sup>®</sup> Remediation vendor design tools. The two-dimensional hydraulic model will also be employed to determine a target temporal EOS<sup>®</sup> 100 injection concentration for the plume in the vicinity of the pilot test.

Prior to actual carbon substrate injections, slug tests will also be performed on two of the injection wells and two new downgradient monitoring wells. Step-rate injection tests will be performed to establish well injection rates and pressures in the injection wells.

The EOS<sup>®</sup> 100 will be injected via gravity flow or pressure injected (if deemed necessary) into the injection wells via a mobile application unit which will consist of a tanker or trailer unit with a manifold piping system and hoses supplied with valves and regulators for control and monitoring rates of injection. Figure 3 presents a process flow diagram of a typical injection system (adapted from AFCEE's Final Protocol for In Situ Bioremediation of Chlorinated Solvents Using Edible Oil, 2007). Water for dilution of the EOS<sup>®</sup> product (which is generally diluted at a ratio of 1:4 parts of EOS<sup>®</sup>: water for sandy/gravelly soils) will be obtained from a hydrant source in the vicinity of the testing area. The water will be scavenged of DO via the addition of a suitable chemical agent such as sodium metabisulfite. Additional designed quantities of deoxygenated push water or chase water will be injected to optimize the distribution of the substrate in the groundwater. The use of deoxygenated water decreases microbial acclimation time as well as reduces potential for biofouling.

Based on the results of the laboratory column studies and field chemical and geochemical sampling, additional injections may be required during the six-month pilot test. The results and progress of the pilot test, as well as the laboratory column tests, will also be used to examine if

strategic and temporary recirculation of groundwater within a defined area between the injection wells and monitoring wells may need to be further evaluated and recommended.

#### **4.4.2 Tracer Study**

A tracer study will be incorporated as part of the pilot test to track the injected EOS®-water solution as it migrates downgradient from the injection well transect, *only if* the results of the borehole test show that there would be no analytical interferences with added salt measurement. Bromide will be used as the tracer and will be injected in designed quantities to examine the zone of influence of groundwater flow. Tracer concentrations will be monitored in samples that are periodically collected from the effectiveness monitoring wells.

### **4.5 PERMITTING REQUIREMENTS**

The pilot test will require a Class V Underground Injection Control (UIC) permit, which allows for the injection of fluids in the saturated subsurface. The general permit falls under Nevada regulation NAC 445A.891.

A permit application will also be submitted for a UIC General Permit for Short-Term Remediation, which will allow for injection of electron donor amendments. The permit is valid for a period of six months. As previously discussed in Section 4.4, more than one injection event may be required to demonstrate bioremediation effectiveness. If more than one injection event is anticipated based on the results of the bench-scale study, an application for a UIC General Permit for Long-Term Remediation may be necessary.

### **4.6 HEALTH AND SAFETY**

Field work will be conducted in accordance with a pilot test area-specific Health and Safety Plan, which will address potential chemical and physical hazards associated with the pilot test. It is anticipated that Level D personal protective equipment will be required for all field activities.

## **5.0 EFFECTIVENESS MONITORING PLAN**

This section describes the conceptual monitoring program associated with groundwater monitoring to determine treatment effectiveness. Effectiveness monitoring will include tracer study monitoring to track migration of the tracer and substrate in the groundwater and periodic groundwater sampling and analysis.

### **5.1 TRACER STUDY MONITORING**

Tracer concentrations in groundwater will be monitored in samples collected from the effectiveness monitoring wells. Sampling frequencies will correspond with the groundwater monitoring program discussed in Section 5.2 and presented in Table 4.

### **5.2 GROUNDWATER MONITORING**

Groundwater samples will be collected from the existing upgradient monitoring wells MW-K5 and PC-98R, newly installed upgradient well (described in Section 3.1.1), injection wells (described in Section 4.3.1), and new monitoring wells (described in Section 4.3.2) prior to the carbon substrate injections to establish baseline conditions. After injections have occurred, groundwater samples will be periodically collected from upgradient and downgradient monitoring wells and analyzed for a variety of field, laboratory, and microbial parameters. Specialized microbial analyses, namely, PLFA analyses and the presence of the perchlorate reductase gene will be determined via the employment of Bio-Traps<sup>®</sup> in select wells during the study. In addition, slug tests will also be repeated at the three-month period and at the end of the pilot test to examine any changes in hydraulic conductivity as a result of carbon injections and geochemical processes. The proposed groundwater sampling protocol is summarized in Table 4. This table describes the parameters to be analyzed, frequency, methods, and the purpose of the analyses.

**This Page Intentionally Left Blank**

## **6.0 REPORTING**

Following completion of the preliminary field and laboratory batch microcosm activities, a technical memorandum will be prepared for NDEP review and comment. The technical memorandum will summarize the results of the preliminary field and laboratory testing described in Section 3.0. The information presented in this technical memorandum will be used to refine the conceptual design of the pilot test, as needed.

Following completion of the test, a Pilot Test Report will be prepared for NDEP review and comment. The report will include the following:

- Summary of column test results;
- Evaluation of geochemical and microbial data from the pilot test;
- Evaluation of bioremediation effectiveness in reducing perchlorate-contaminated groundwater;
- Determination of degradation kinetics; and
- Preliminary cost-benefit analysis to determine the technology's feasibility and cost effectiveness for full-scale application and to identify an engineering system and layout that is most feasible.

**This Page Intentionally Left Blank**

## **7.0 SCHEDULE**

Figure 4 provides a schedule for completion of the preliminary field and laboratory activities; submittal of the technical memorandum; implementation, operation, and monitoring of the pilot test; and submittal of the Pilot Test Report.

**This Page Intentionally Left Blank**



## 8.0 REFERENCES

- ASTM D4874-95, Standard Test Method for Leaching Solid Waste in a Column Apparatus, Annual Book of ASTM Standards, vol. 11.04, ASTM D-4874-95 (2003) (reapproved 2001), American Society for Testing and Materials.
- ASTM International (ASTM), 2008. Standard Test Method for (Field Procedure) for Instantaneous Change in Head (Slug) Tests for Determining Hydraulic Properties of Aquifers. ASTM Standard D4044-96. Reapproved September 2008.
- AFCEE. 2004. Final Principles and Practices of Anaerobic Bioremediation of Chlorinated Solvents. August, 2004.
- AFCEE. 2007. Final Protocol for In Situ Bioremediation of Chlorinated Solvents Using Edible Oil. October, 2007.
- AFCEE. 2008. Final Technical Protocol for Enhanced Anaerobic Bioremediation Using Permeable Mulch Biowalls and Bioreactors. May, 2008.
- C Tech Development Corporation (C Tech), 2014. *Mining Visualization System, Version 9.88*. C Tech Development Corporation, Henderson, Nevada.
- Duffield, G.M, 2014. AQTESOLV for Windows Version 4.5 Users Guide. HydroSOLVE Inc., Reston, Virginia.
- Elkins, B., Robert Borden, and Ed Alperin. 2014. "Electrochemical and Physical Mechanisms Affecting Subsurface Distribution of Electron Donor for Enhanced Anaerobic Bioremediation." AEHS 30<sup>th</sup> Annual International Conference on Soils, Sediments, Water, and Energy. Amherst, Massachusetts. October 20-23, 2014.
- ENVIRON, 2012. *Site Management Plan (SMP), Nevada Environmental Response Trust Site, Clark County, Nevada*. May 2012.
- ENVIRON, 2013. *Treatability Study Work Plan. Permeable Reactive Barrier Pilot. Revision 1. NERT Site*. Henderson, Nevada. December, 2013.
- ENVIRON, 2014a. *Treatability Study Work Plan, Permeable Reactive Barrier Pilot, Revision 2, Nevada Environmental Response Trust Site, Henderson, Nevada*. May 9, 2014.
- ENVIRON, 2014b. *Field Sampling Plan, Revision 1, Nevada Environmental Response Trust Site, Henderson, Nevada*. July 18, 2014.
- ENVIRON, 2014c. *Quality Assurance Project Plan, Revision 1, Nevada Environmental Response Trust Site, Henderson, Nevada*. July 18, 2014.
- ESTCP, 2010. Biologically Active Zone Enhancement (BAZE) for In Situ RDX Degradation in Ground Water. January, 2010.
- ITRC, 2008. Technical/Regulatory Guidance. Remediation Technologies for Perchlorate Contamination for Water and Soil. March 2008.

Northgate (Northgate Environmental Management, Inc.), 2010. *Work Plan to Conduct In-Situ Permeable Reactive Barrier Pilot Test for Perchlorate-Impacted Groundwater*, Tronox LLC, Henderson, Nevada. October 25.

Perlmutter, W.M., Ronnie Britto, James D. Cowan, and Alan R. Jacobs. 2000. "In Situ Biotreatment of Perchlorate and Chromium in Groundwater," *Proceedings of the Sixth Annual in Situ and On-Site Bioremediation Symposium, San Diego, California*. The Battelle Press. May 2000.

Pittrak, M., Mares, S., Kobr, M., 2007. *A Simple Borehole Dilution Technique in Measuring Horizontal Groundwater Flow*. Ground Water, Vol. 45, No. 1, January-February 2007.

Shaw (Shaw Environmental, Inc.), 2010. Proposal for Demonstration of Perchlorate Treatment Within Groundwater Using an Injected Permeable Reactive Barrier. February 14.

Tetra Tech, 2014. Draft Revised Soil Flushing Pilot Test Work Plan. October, 17, 2014.

Wilson, J. L. and P. J. Miller. 1978. *Two-Dimensional Plume in Uniform Ground-Water Flow*. Journal of the Hydraulics Division, ASCE, Vol. 104, No. HY4, pp. 503-514. 1978.

## **TABLES**

**This Page Intentionally Left Blank**

**Table 1**  
**Baseline Soil Sampling Protocol - Field and Homogenized Soil**

Parameter	Method	Purpose
<b>Soil Sampling Protocol</b>		
Perchlorate	E314	Estimate mass of perchlorate in saturated soil
TOC	E415	Estimate available natural organic carbon
Soil pH	SW9045	Assess geochemical conditions
Soluble Cations and Anions <sup>1</sup>	Note 1 Note 2	Assess salt loading
TDS <sup>2</sup>	E160.1	Assess salt loading
Metals <sup>3</sup>	SW6020	Assess potential secondary impacts of treatment
Hexavalent Chromium	SW7199	Assess potential secondary impacts of treatment
PLFA	Microbial Insights SOP	Examine native/natural microbial perchlorate characteristics
Perchlorate reductase gene	Microbial Insights SOP	Examine native/natural microbial perchlorate characteristics

Acronyms and Abbreviations

TOC: total organic carbon

TDS: total dissolved solids

PLFA: phospholipid fatty acids

Notes

1. Cations include sodium, potassium, calcium, and magnesium (Method SW6020). Anions include chloride, sulfate, nitrate (Method E300/SW9056), carbonate, and bicarbonate (Method E2320B)
2. Analysis to be performed on water extract prepared per method SW9056.
3. Metals include arsenic, chromium, iron, and manganese.

**Table 2**  
**Batch Microcosm Testing Sampling Protocol**

<b>Parameter</b>	<b>Method</b>	<b>Purpose</b>
<b>Microcosm Water Sampling</b>		
Perchlorate	E314	Assess treatment effectiveness
TOC	E415	Assessment of organic carbon substrate uptake
Nitrate	E300/SW9056	Assessment of the role of denitrification/electron acceptor competition
Sulfate	E300/SW9056	Estimate role of this electron acceptor for potential carbon substrate uptake
pH	Lab Instrument	Assess geochemical conditions
Total Nitrogen	E351.1	Examine need for micronutrients
Total Phosphorus	E365.1	Examine need for micronutrients
Total Dissolved Solids	E160.1	Assess impact on perchlorate biodegradation
Chloride	E300/SW9056	Potential estimation of conservative end-product of biodegradation
<b>Final Soil Sampling</b>		
PLFA	Microbial Insights SOP	Examine response of native microbial perchlorate characteristics to carbon substrate addition
Perchlorate reductase gene	Microbial Insights SOP	Examine response of native microbial perchlorate characteristics to carbon substrate addition

Acronyms and Abbreviations

TOC: total organic carbon

PLFA: phospholipid fatty acids

**Table 3**  
**Laboratory Column Testing Sampling Protocol**

<b>Parameter</b>	<b>Method</b>	<b>Purpose</b>
<b>Port/Effluent Water Sampling Protocol</b>		
pH	Lab Instrument	Assess geochemical conditions
EC	Lab Instrument	Assess geochemical conditions
DO	Lab Instrument	Assess geochemical conditions
ORP	Lab Instrument	Assess geochemical conditions
Perchlorate	E314	Assess treatment effectiveness
TOC	E415	Assess longevity of the carbon substrate
TDS	E160.1	Assess any impact of salts on delayed or slower perchlorate biodegradation in the flow through mode
Chloride	E300/SW9056	Potential estimation of conservative end-product of biodegradation
Chlorate/Chlorite	E300.1	Assess treatment effectiveness and examination as intermediate by-product of perchlorate biodegradation
Sulfate	E300/SW9056	Assess treatment effectiveness and examination as intermediate by-product of perchlorate biodegradation
Sulfide	HACH Method 8131	Examine secondary geochemical impacts
Nitrate	E300/SW9056	Assessment of nitrate as the most likely competing electron acceptor and carbon substrate consumer
Ferrous and Ferric Iron	HACH Method 8008 & 8147	Assess effect of reducing conditions on iron
Total Nitrogen	E351.1	Examine the need for micronutrients
Total Phosphorus	E365.1	Examine the need for micronutrients
Manganese (II)	SW846 6010B	Assess potential for leaching of biologically-driven dissolved manganese
Dissolved Metals	SW6010/6020	Assess secondary impacts of treatment
Hexavalent Chromium	SW7199	Assess secondary impacts of treatment
<b>Final Soil Sampling</b>		
PLFA	Microbial Insights SOP	Examine response of native microbial perchlorate characteristics to substrate addition
Perchlorate reductase gene	Microbial Insights SOP	Examine response of native microbial perchlorate characteristics to substrate addition

Acronyms and Abbreviations

EC: electrical conductivity

DO: dissolved oxygen

ORP: oxidation-reduction potential

TOC: total organic carbon

TDS: total dissolved solids

PLFA: phospholipid fatty acids

**Table 4**  
**Groundwater Sampling Protocol**

Parameter	Method	Frequency	Purpose
pH	Field meter	Baseline, Biweekly <sup>1</sup> , Monthly	Assess geochemical conditions
EC	Field meter	Baseline, Biweekly <sup>1</sup> , Monthly	Assess geochemical conditions
DO	Field meter	Baseline, Biweekly <sup>1</sup> , Monthly	Assess geochemical conditions
ORP	Field meter	Baseline, Biweekly <sup>1</sup> , Monthly	Assess geochemical conditions
Temperature	Field meter	Baseline, Biweekly <sup>1</sup> , Monthly	Assess geochemical conditions
Bromide	E300	Baseline, Biweekly <sup>1</sup> , Monthly	Indirect estimate of groundwater velocity and carbon substrate transport in the aquifer
Perchlorate	E314	Baseline, Biweekly <sup>1</sup> , Monthly	Assess treatment effectiveness
TOC	E415	Baseline, Biweekly <sup>1</sup> , Monthly	Assess carbon substrate distribution in the aquifer
TDS	E160.1	Baseline, Biweekly <sup>1</sup> , Monthly	Assess any impact of salts on delayed or slower perchlorate biodegradation in the flow through mode
Alkalinity	E310.2	Baseline, Biweekly <sup>1</sup> , Monthly	Assess geochemical conditions
Chlorate/Chlorite	E300.1	Baseline, Biweekly <sup>1</sup> , Monthly	Assess treatment effectiveness and examination as intermediate by-product of perchlorate biodegradation
Chloride	E300/SW9056	Baseline, Biweekly <sup>1</sup> , Monthly	Potential estimation of conservative end-product of biodegradation in the field
Ferrous and Ferric Iron	HACH Method 8008 & 8147	Baseline, Biweekly <sup>1</sup> , Monthly	Assess effect of reducing conditions on iron
Hardness	E130.1	Baseline, Biweekly <sup>1</sup> , Monthly	Assess geochemical conditions
Sulfate	E300/SW9056	Baseline, Biweekly <sup>1</sup> , Monthly	Assessment of sulfate as an electron acceptor and potential carbon substrate consumer
Sulfide	HACH Method 8131	Baseline, Biweekly <sup>1</sup> , Monthly	Examine secondary geochemical impacts
Nitrate	E300/SW9056	Baseline, Biweekly <sup>1</sup> , Monthly	Assessment of nitrate as the most likely competing electron acceptor and carbon substrate consumer



Parameter	Method	Frequency	Purpose
Manganese	SW846 6010B	Baseline, Biweekly <sup>1</sup> , Monthly	Assess potential for biologically-driven dissolution of manganese
Methane	EPA Method RSK175	Baseline, Biweekly <sup>1</sup> , Monthly	Examine secondary geochemical impacts
Total Nitrogen	E351.1	Baseline, Biweekly <sup>1</sup> , Monthly	Examine the need for micronutrients
Total Phosphorus	E365.1	Baseline, Biweekly <sup>1</sup> , Monthly	Examine the need for micronutrients
Dissolved Metals	SW6010/6020	Baseline, Monthly	Assess secondary impacts of treatment
Hexavalent Chromium	SW7199	Baseline, Monthly	Assess secondary impacts of treatment
Volatile Fatty Acids	SW8015- Modified	Baseline, Monthly	Surrogate carbon substrate assessment
PLFA	Microbial Insights Bio- Traps <sup>®</sup>	One event in strategic wells	Examine microbial response to carbon substrate addition in the field
Perchlorate reductase gene	Microbial Insights Bio- Traps <sup>®</sup>	One event in strategic wells	Examine microbial response to carbon substrate addition in the field

Acronyms and Abbreviations

EC: electrical conductivity

DO: dissolved oxygen

ORP: oxidation-reduction potential

TOC: total organic carbon

TDS: total dissolved solids

PLFA: phospholipid fatty acids

Notes



1. Biweekly Sampling will be conducted once every two weeks for only the first two months after injections

**This Page Intentionally Left Blank**

## **FIGURES**

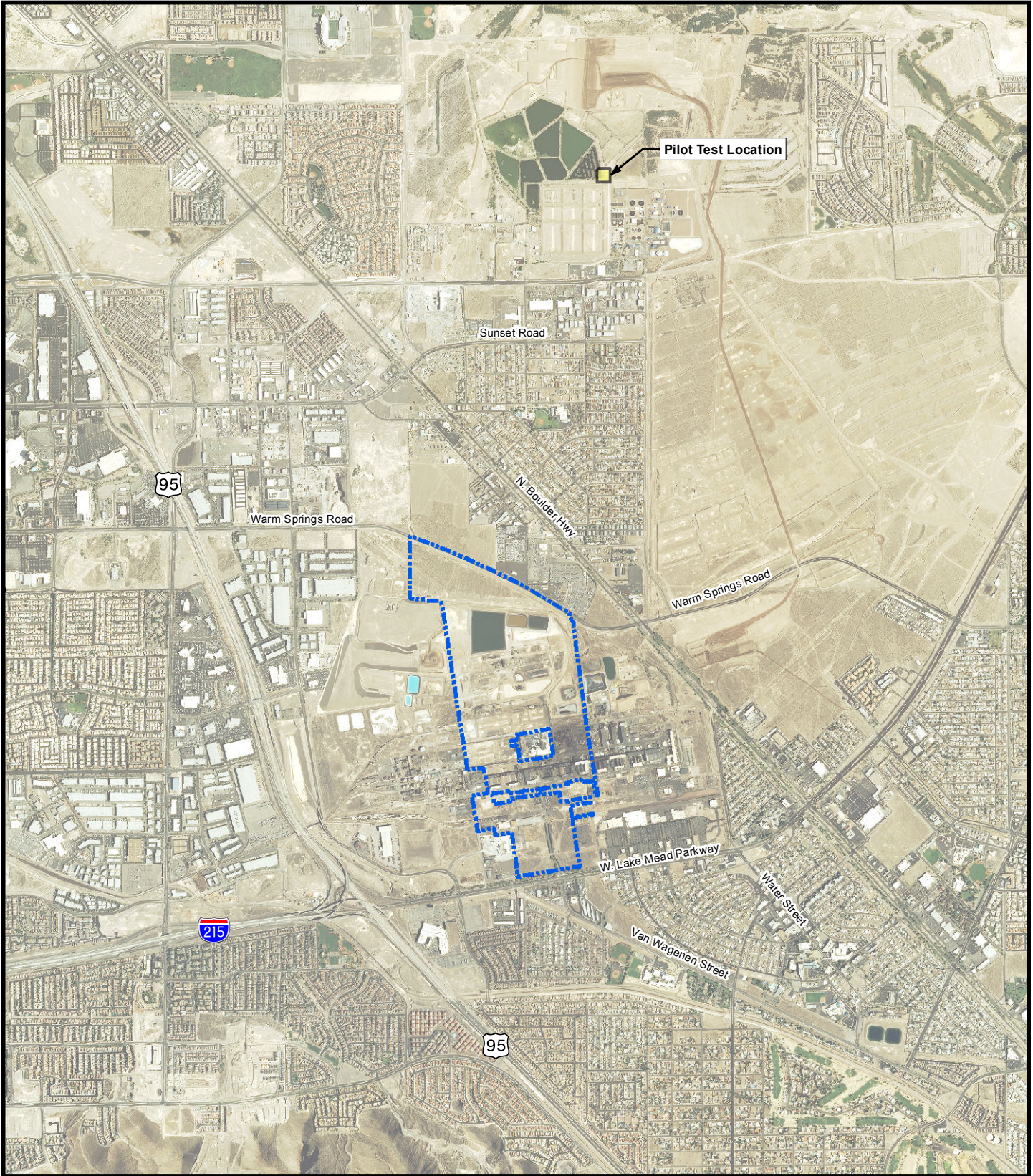
**This Page Intentionally Left Blank**



-  Pilot Test Location
-  Site Boundary



0 1,500 3,000  
Feet

Source:  
NAIP 2013 aerial photograph.



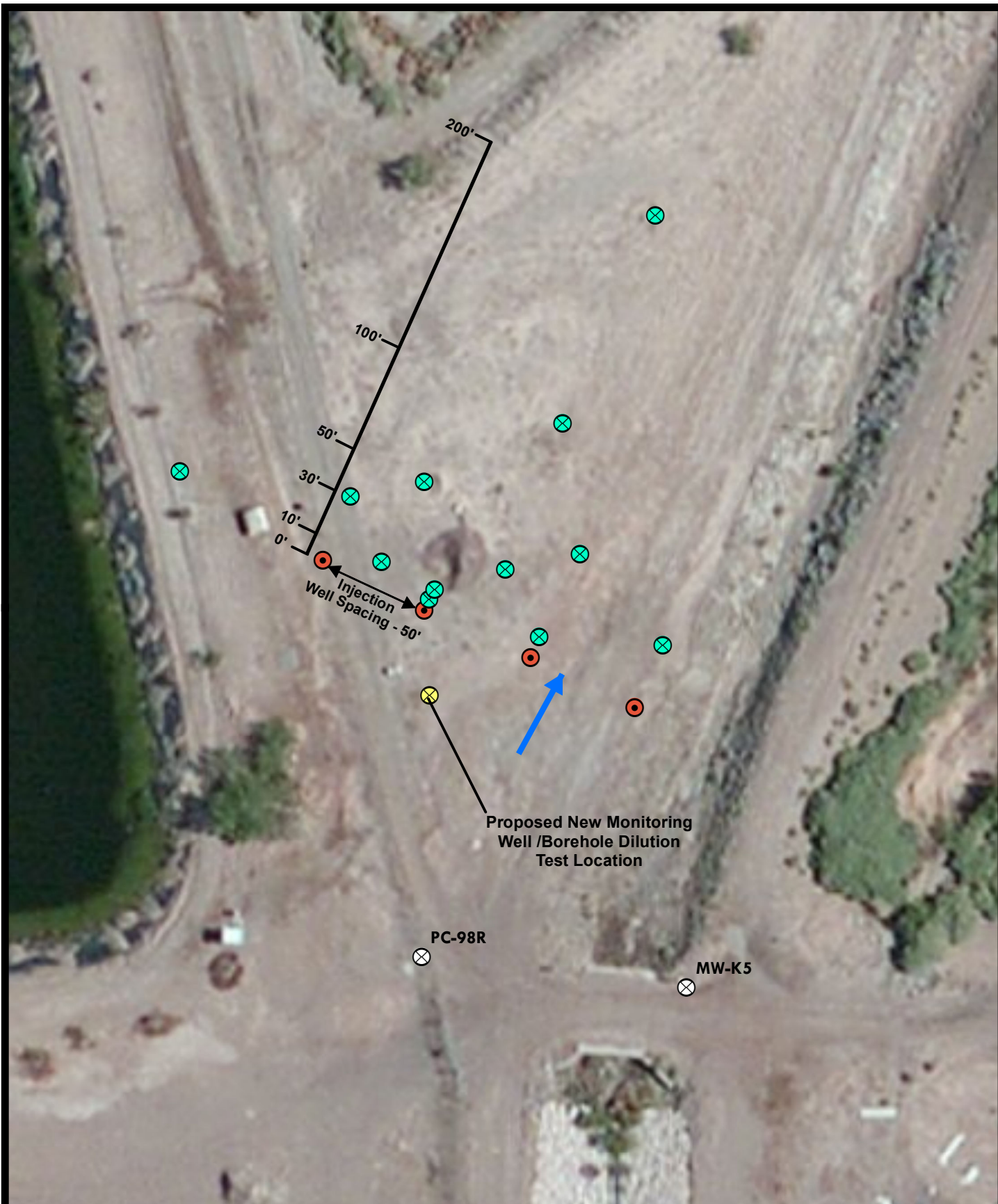

NEVADA ENVIRONMENTAL  
RESPONSE TRUST

**Figure 1**  
**Pilot Test Location**





**Legend**

-  Existing Monitoring Well
-  Injection Well
-  Monitoring Well / Borehole
-  Monitoring Well
-  Groundwater Flow



Note: Pilot Test Area located within Parcel Boundary 161-36-701-005.

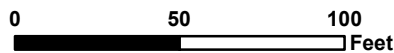

Source: ESRI 2010 Bing Imagery

NEVADA ENVIRONMENTAL  
RESPONSE TRUST

**Figure 2**  
**Conceptual Pilot Test Layout**



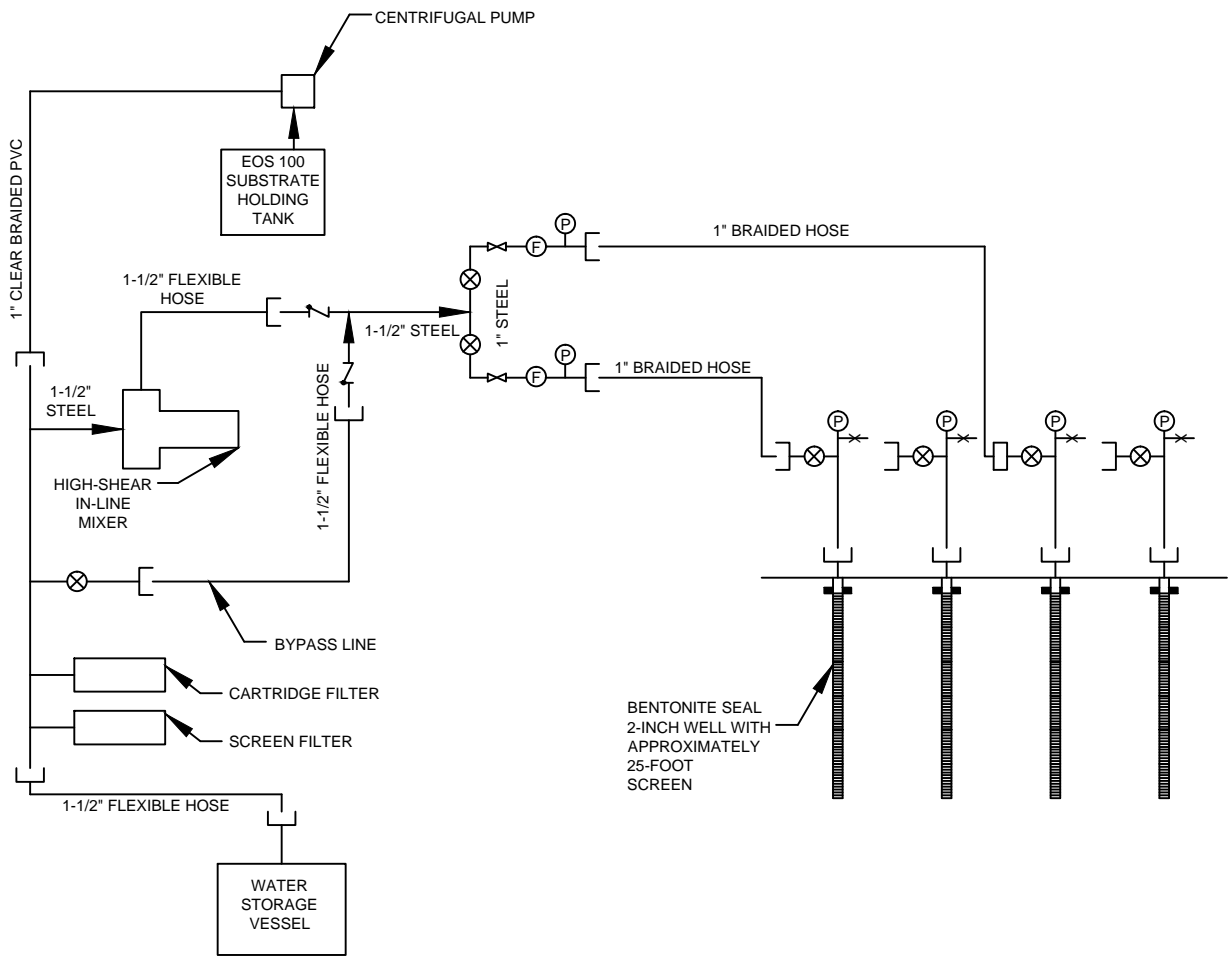

(P) PRESSURE GAGE

(F) FLOW METER/ ACCUMULATOR

⊗ VALVE - GATE

⊗ VALVE - BALL

— ] — QUICK-CONNECT UNION

⊙ WATER METER

∩ CHECK VALVE

— ✕ — AIR BLEED VALVE

NEVADA ENVIRONMENTAL  
RESPONSE TRUST

FIGURE 3

CONCEPTUAL PROCESS  
FLOW DIAGRAM

 TETRA TECH

Figure 4  
Schedule for Groundwater Bioremediation Pilot Test

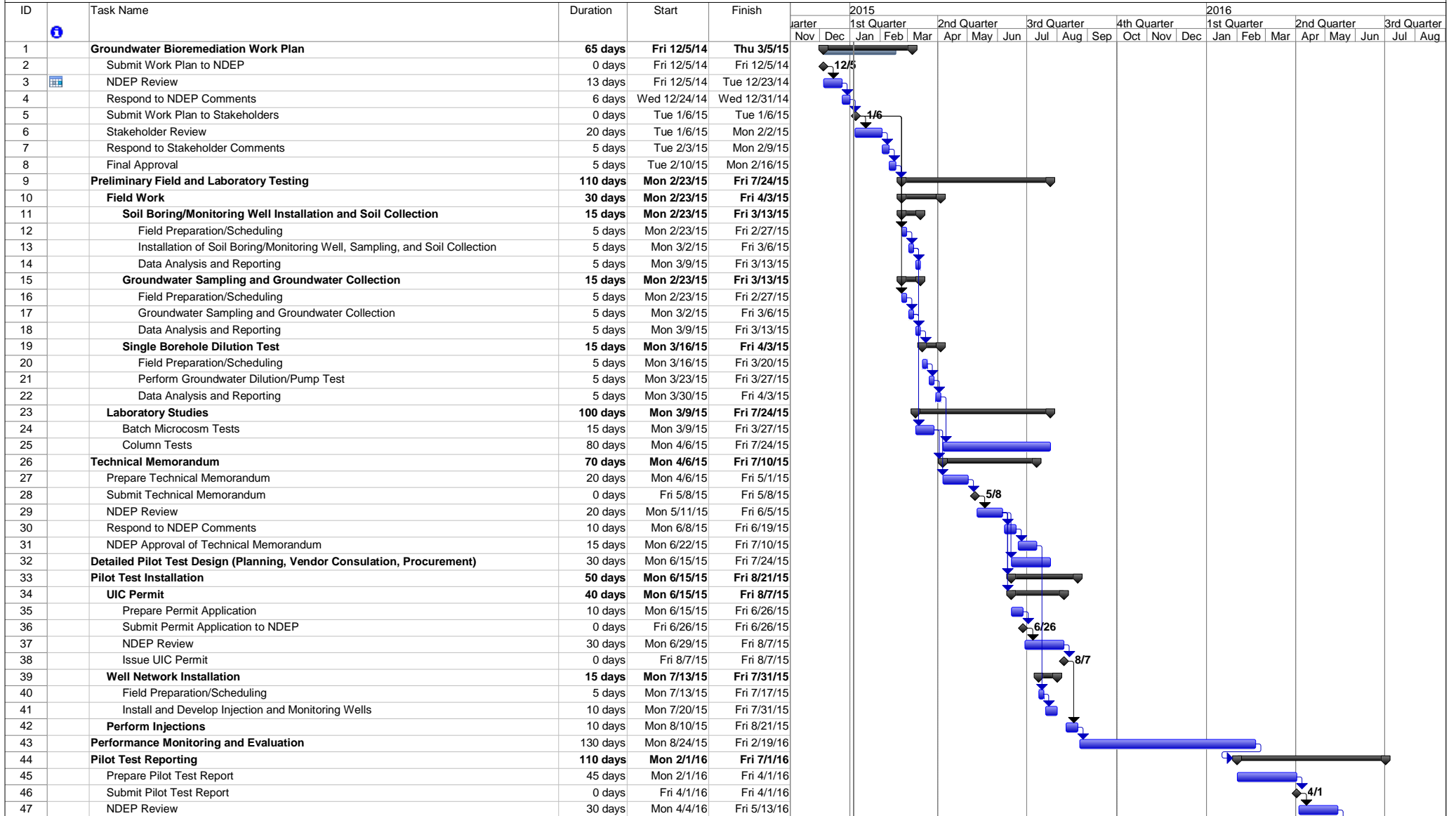

Project: Figure 4 Date: Mon 1/5/15	Task		Project Summary		Inactive Milestone		Manual Summary Rollup		Progress	
	Split		External Tasks		Inactive Summary		Manual Summary		Deadline	
	Milestone		External Milestone		Manual Task		Start-only			
	Summary		Inactive Task		Duration-only		Finish-only			

Note: This schedule presumes that necessary approvals from the NDEP and City of Henderson will be granted within the stated timeframes.





**This Page Intentionally Left Blank**