

81 Environmental Tech
13550 N Highway 93
Las Vegas, NV 89165

Ticket Type: INBOUND INVOICE

Ticket Number: 1519
Date: 10/01/2010
Time In: 12:25 am
Time Out: 12:49 am

Customer: 001011 - NGE, LLC c/o Northgate Environ Mgmt

Vehicle/Container: 44165A
Contract: Northgate Env. On Site Soils 3825 11
Comment: 3825 10 11244

Gross Weight: 118,460 LB Manual In
Tare Weight: 48,960 LB Manual Out
Net Weight: 69500 LB
Net Tons: 34.75

BOL: 11626

Origin	Yards	Material	Billing Quantity
Not Applicable	0.00 YD	SW CONTAMINATED SOIL	34.75 TN

Driver:

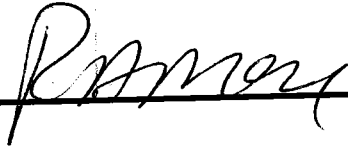

Weighmaster:

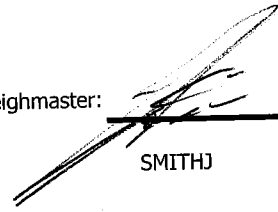
SMITHJ

Indemnification. Customer agrees, by signature above, to indemnify, hold harmless, and defend Republic Services, Inc., its subsidiaries, affiliates, employees, officers and directors from and against any and all liabilities, claims, penalties, forfeitures, suits and the costs and expenses incident thereto, including costs of defense, settlement, and reasonable attorney's fees, which may be incurred, as a result of death or injuries to any person, or damage to any property, contamination of or adverse effects on the environment, caused in whole or in part by the Customer, its employees, or subcontractors in disposing waste at this Facility. In the event Customer delivers Unacceptable Waste (as determined by Republic) Customer agrees to assume all expenses and obligations with the removal and/or resolution of any effects caused by the delivery of such Unacceptable Waste.

Indemnización. Cliente acuerda indemnizar, mantener inmune, y defender Republic Services, Inc., sus subsidiarios, compañías, divisiones, empleados, oficiales y directores contra de cualquiera y de todas responsabilidades, demandas, penas, pérdidas, juicios, pleitos y los costos incidente además, incluyendo costos de defensa, de acuerdo judicial, y de honorarios razonables del abogado, que pueden ser incurridos en, o como resultado de, la muerte o herida personal a cualquier persona, o daños a cualquier característica, propiedad, contaminación de la tierra o efectos ilícitos en esta Facilidad, causado entero o en parte por el cliente, sus empleados, o sus subcontratistas en botar basura en esta Facilidad. En el caso que el Cliente entrega, bota, basura (según lo determinado por Republic) en este Establecimiento basura inaceptable en los reglamentos de este Establecimiento, el Cliente se compromete asumir todos los costos y obligaciones con el retiro y/o la resolución de cualquier dano(s) causado por la entrega de tal basura inaceptable.



NON-HAZARDOUS WASTE MANIFEST

MANIFEST # 11626

GENERATOR INFORMATION

Generator Name: Tronox LLCAddress: P.O. Box 55City: Henderson County: ClarkState: NV Zip: 89009Site Location (if different): 560 W. Lake MeadHenderson, NV 89015 (702) 592-7727

CUSTOMER/BILLING INFORMATION

Billing Name: NGE LLC c/o Northgate Environment ManagementAddress: 300 Frank Ogawa Plaza, Ste 510City: Oakland County: AlamedaState: CA Zip: 94612

Republic Services Approval #	Description of Waste	Volume/Weight	Expiration Date	Container Type
38251011244	Soil for disposal		12-31-2011	Tractor with Dump Trailer(s)
	RZ-_____ # _____	34.75 TL		

*Attach Additional Sheet if necessary

I hereby certify that the above-described materials are non-hazardous wastes as defined by 40 CFR 261 or any applicable state law. Further, that the above named materials are properly classified, described, packaged, marked and labeled, and are in proper condition for transportation according to the applicable regulations of the Department of Transportation.

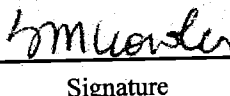
Susan Crowley 
 Generator/Authorized Agent Name Signature Date Shipped

TRANSPORTER INFORMATION

Transporter Name: Las Vegas PavingDOT # 191949Address: 4420 S. DecaturTruck Number: 15001Las Vegas, NV 89103Phone Number: (702) 353-4355

I certify no hazardous waste or other regulated substance was knowingly introduced to the waste while in my custody. The waste transported in this vehicle is the waste identified above, to the best of my knowledge.

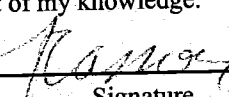
Ramon 
 Name of Authorized Agent Signature Date Delivered 9-30-10

DISPOSAL SITE INFORMATION

Site Name: Apex Regional LandfillPhone No. (702) 599-5920Address: 13550 U.S. Hwy 93 Las Vegas, NV

I hereby acknowledge receipt of the above described materials

Ramon 
 Name (Print or Type) Signature Date Received 10-1-10

81 Environmental Tech
13550 N Highway 93
Las Vegas, NV 89165

Ticket Type: INBOUND INVOICE

Ticket Number: 1520
Date: 10/01/2010
Time In: 12:33 am
Time Out: 12:55 am

Customer: 001011 - NGE, LLC c/o Northgate Environ Mgmt

Vehicle/Container: 76810P
Contract: Northgate Env. On Site Soils 3825 11
Comment: 3825 10 11244

Gross Weight: 127,260 LB Manual In
Tare Weight: 54,200 LB Manual Out
Net Weight: 73060 LB
Net Tons: 36.53

BOL: 11627

Origin	Yards	Material	Billing	Quantity
Not Applicable	0.00 YD	SW CONTAMINATED SOIL	36.53	TN

Driver: _____

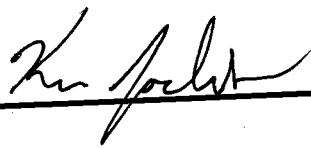

Weighmaster: _____

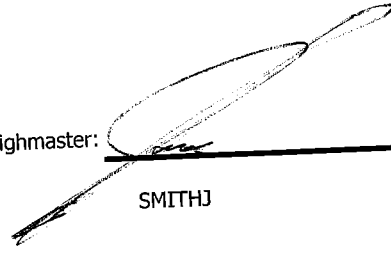

SMITHJ

Indemnification. Customer agrees, by signature above, to indemnify, hold harmless, and defend Republic Services, Inc., its subsidiaries, affiliates, employees, officers and directors from and against any and all liabilities, claims, penalties, forfeitures, suits and the costs and expenses incident thereto, including costs of defense, settlement, and reasonable attorney's fees, which may be incurred, as a result of death or injuries to any person, or damage to any property, contamination of or adverse effects on the environment, caused in whole or in part by the Customer, its employees, or subcontractors in disposing waste at this Facility. In the event Customer delivers Unacceptable Waste (as determined by Republic) Customer agrees to assume all expenses and obligations with the removal and/or resolution of any effects caused by the delivery of such Unacceptable Waste.

Indemnización. Cliente acuerda indemnizar, mantener inmune, y defender Republic Services, Inc., sus subsidiarios, compañías, divisiones, empleados, oficiales y directores contra de cualquiera y de todas responsabilidades, demandas, penas, pérdidas, juicios, pleitos y los costos incidente además, incluyendo costos de defensa, de acuerdo judicial, y de honorarios razonables del abogado, que pueden ser incurridos en, o como resultado de, la muerte o herida personal a cualquier persona, o daños a cualquier característica, propiedad, contaminación de la tierra o efectos ilícitos en esta Facilidad, causado entero o en parte por el cliente, sus empleados, o sus subcontratistas en botar basura en esta Facilidad. En el caso que el Cliente entrega, bota, basura (según lo determinado por Republic) en este Establecimiento basura inaceptable en los reglamentos de este Establecimiento, el Cliente se compromete asumir todos los costos y obligaciones con el retiro y/o la resolución de cualquier dano(s) causado por la entrega de tal basura inaceptable.



NON-HAZARDOUS WASTE MANIFEST

MANIFEST # 11627

GENERATOR INFORMATION

Generator Name: Tronox LLC

Address: P.O. Box 55

City: Henderson County: Clark

State: NV Zip: 89009

Site Location (if different): 560 W. Lake Mead

Henderson, NV 89015 (702) 592-7727

CUSTOMER/BILLING INFORMATION

Billing Name: NGE LLC c/o Northgate Environment Management

Address: 300 Frank Ogawa Plaza, Ste 510

City: Oakland County: Alameda

State: CA Zip: 94612

Republic Services Approval #	Description of Waste	Volume/Weight	Expiration Date	Container Type
38251011244	Soil for disposal		12-31-2011	Tractor with Dump Trailer(s)
	RZ- #	36.53 TON		

*Attach Additional Sheet if necessary

I hereby certify that the above-described materials are non-hazardous wastes as defined by 40 CFR 261 or any applicable state law. Further, that the above named materials are properly classified, described, packaged, marked and labeled, and are in proper condition for transportation according to the applicable regulations of the Department of Transportation.

Susan Crowley Generator/Authorized Agent Name Signature Date Shipped

TRANSPORTER INFORMATION

Transporter Name: Las Vegas Paving

DOT # 191949

Address: 4420 S. Decatur

Truck Number: 241

Las Vegas, NV 89103

Phone Number: (702) 353-4355

I certify no hazardous waste or other regulated substance was knowingly introduced to the waste while in my custody. The waste transported in this vehicle is the waste identified above, to the best of my knowledge.

KEW JACKSHAW Name of Authorized Agent Signature Date Delivered 9-30-2010

DISPOSAL SITE INFORMATION

Site Name: Apex Regional Landfill

Phone No. (702) 599-5920

Address: 13550 U.S. Hwy 93 Las Vegas, NV

I hereby acknowledge receipt of the above described materials

Name (Print or Type) Signature Date Received

81 Environmental Tech
13550 N Highway 93
Las Vegas, NV 89165

Ticket Type: INBOUND INVOICE

Ticket Number: 1521
Date: 10/01/2010
Time In: 12:33 am
Time Out: 12:56 am

Customer: 001011 - NGE, LLC c/o Northgate Environ Mgmt

Vehicle/Container: 82418P
Contract: Northgate Env. On Site Soils 3825 11
Comment: 3825 10 11244

Gross Weight: 137,500 LB Manual In
Tare Weight: 63,760 LB Manual Out
Net Weight: 73,740 LB
Net Tons: 36.87

BOL: 11628

Origin	Yards	Material	Billing Quantity
Not Applicable	0.00 YD	SW CONTAMINATED SOIL	36.87 TN

Driver: _____

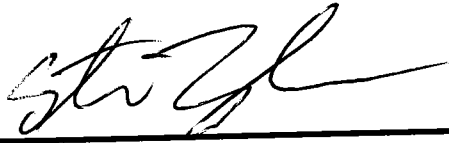

Weighmaster: _____

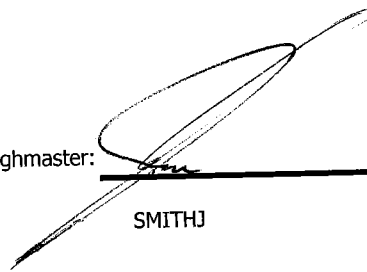

SMITHJ

Indemnification. Customer agrees, by signature above, to indemnify, hold harmless, and defend Republic Services, Inc., its subsidiaries, affiliates, employees, officers and directors from and against any and all liabilities, claims, penalties, forfeitures, suits and the costs and expenses incident thereto, including costs of defense, settlement, and reasonable attorney's fees, which may be incurred, as a result of death or injuries to any person, or damage to any property, contamination of or adverse effects on the environment, caused in whole or in part by the Customer, its employees, or subcontractors in disposing waste at this Facility. In the event Customer delivers Unacceptable Waste (as determined by Republic) Customer agrees to assume all expenses and obligations with the removal and/or resolution of any effects caused by the delivery of such Unacceptable Waste.

Indemnización. Cliente acuerda indemnizar, mantener inmune, y defender Republic Services, Inc., sus subsidiarios, compañías, divisiones, empleados, oficiales y directores contra de cualquiera y de todas responsabilidades, demandas, penas, pérdidas, juicios, pleitos y los costos incidente además, incluyendo costos de defensa, de acuerdo judicial, y de honorarios razonables del abogado, que pueden ser incurridos en, o como resultado de, la muerte o herida personal a cualquier persona, o daños a cualquier característica, propiedad, contaminación de la tierra o efectos ilícitos en esta Facilidad, causado entero o en parte por el cliente, sus empleados, o sus subcontratistas en botar basura en esta Facilidad. En el caso que el Cliente entrega, bota, basura (según lo determinado por Republic) en este Establecimiento basura inaceptable en los reglamentos de este Establecimiento, el Cliente se compromete asumir todos los costos y obligaciones con el retiro y/o la resolución de cualquier dano(s) causado por la entrega de tal basura inaceptable.



NON-HAZARDOUS WASTE MANIFEST

MANIFEST # 11628

GENERATOR INFORMATION

Generator Name: Tronox LLCAddress: P.O. Box 55City: Henderson County: ClarkState: NV Zip: 89009Site Location (if different): 560 W. Lake MeadHenderson, NV 89015 (702) 592-7727

CUSTOMER/BILLING INFORMATION

Billing Name: NGE LLC c/o Northgate Environment ManagementAddress: 300 Frank Ogawa Plaza, Ste 510City: Oakland County: AlamedaState: CA Zip: 94612

Republic Services Approval #	Description of Waste	Volume/Weight	Expiration Date	Container Type
38251011244	Soil for disposal		12-31-2011	Tractor with Dump Trailer(s)
	RZ- _____ # _____	36.87 Tons		

*Attach Additional Sheet if necessary

I hereby certify that the above-described materials are non-hazardous wastes as defined by 40 CFR 261 or any applicable state law. Further, that the above named materials are properly classified, described, packaged, marked and labeled, and are in proper condition for transportation according to the applicable regulations of the Department of Transportation.

Susan Crowley [Signature] _____
 Generator/Authorized Agent Name Signature Date Shipped

TRANSPORTER INFORMATION

Transporter Name: Las Vegas PavingDOT # 191949Address: 4420 S. DecaturTruck Number: 220Las Vegas, NV 89103Phone Number: (702) 353-4355

I certify no hazardous waste or other regulated substance was knowingly introduced to the waste while in my custody. The waste transported in this vehicle is the waste identified above, to the best of my knowledge.

STEVE TAYLOR [Signature] 9-30-10
 Name of Authorized Agent Signature Date Delivered

DISPOSAL SITE INFORMATION

Site Name: Apex Regional LandfillPhone No. (702) 599-5920Address: 13550 U.S. Hwy 93 Las Vegas, NV

I hereby acknowledge receipt of the above described materials

[Signature] [Signature] 10-1-10
 Name (Print or Type) Signature Date Received

81 Environmental Tech
13550 N Highway 93
Las Vegas, NV 89165

Ticket Type: INBOUND INVOICE

Ticket Number: 1522
Date: 10/01/2010
Time In: 12:43 am
Time Out: 1:04 am

Customer: 001011 - NGE, LLC c/o Northgate Environ Mgmt

Vehicle/Container: A004505
Contract: Northgate Env. On Site Soils 3825 11
Comment: 3825 10 11244630

Gross Weight: 76,920 LB Manual In
Tare Weight: 37,600 LB Manual Out
Net Weight: 39320 LB
Net Tons: 19.66

BOL: 11630

Origin	Yards	Material	Billing	Quantity
Not Applicable	0.00 YD	SW CONTAMINATED SOIL	19.66	TN

Driver: _____



Weighmaster: _____

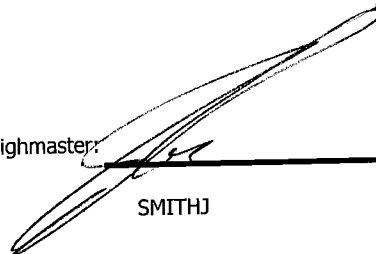

SMITHJ

Indemnification. Customer agrees, by signature above, to indemnify, hold harmless, and defend Republic Services, Inc., its subsidiaries, affiliates, employees, officers and directors from and against any and all liabilities, claims, penalties, forfeitures, suits and the costs and expenses incident thereto, including costs of defense, settlement, and reasonable attorney's fees, which may be incurred, as a result of death or injuries to any person, or damage to any property, contamination of or adverse effects on the environment, caused in whole or in part by the Customer, its employees, or subcontractors in disposing waste at this Facility. In the event Customer delivers Unacceptable Waste (as determined by Republic) Customer agrees to assume all expenses and obligations with the removal and/or resolution of any effects caused by the delivery of such Unacceptable Waste.

Indemnización. Cliente acuerda indemnizar, mantener inmune, y defender Republic Services, Inc., sus subsidiarios, compañías, divisiones, empleados, oficiales y directores contra de cualquiera y de todas responsabilidades, demandas, penas, pérdidas, juicios, pleitos y los costos incidente además, incluyendo costos de defensa, de acuerdo judicial, y de honorarios razonables del abogado, que pueden ser incurridos en, o como resultado de, la muerte o herida personal a cualquier persona, o daños a cualquier característica, propiedad, contaminación de la tierra o efectos ilícitos en esta Facilidad, causado entero o en parte por el cliente, sus empleados, o sus subcontratistas en botar basura en esta Facilidad. En el caso que el Cliente entrega, bota, basura (según lo determinado por Republic) en este Establecimiento basura inaceptable en los reglamentos de este Establecimiento, el Cliente se compromete asumir todos los costos y obligaciones con el retiro y/o la resolución de cualquier dano(s) causado por la entrega de tal basura inaceptable.



NON-HAZARDOUS WASTE MANIFEST

MANIFEST # 11630

GENERATOR INFORMATION

Generator Name: Tronox LLCAddress: P.O. Box 55City: Henderson County: ClarkState: NV Zip: 89009Site Location (if different): 560 W. Lake MeadHenderson, NV 89015 (702) 592-7727

CUSTOMER/BILLING INFORMATION

Billing Name: NGE LLC c/o Northgate Environment ManagementAddress: 300 Frank Ogawa Plaza, Ste 510City: Oakland County: AlamedaState: CA Zip: 94612

Republic Services Approval #	Description of Waste	Volume/Weight	Expiration Date	Container Type
38251011244	Soil for disposal		12-31-2011	Tractor with Dump Trailer(s)
	RZ- _____ # _____	19.66		

*Attach Additional Sheet if necessary

I hereby certify that the above-described materials are non-hazardous wastes as defined by 40 CFR 261 or any applicable state law. Further, that the above named materials are properly classified, described, packaged, marked and labeled, and are in proper condition for transportation according to the applicable regulations of the Department of Transportation.

Susan Crowley
 Generator/Authorized Agent Name

Susan Crowley
 Signature

Date Shipped

TRANSPORTER INFORMATION

Transporter Name: Las Vegas PavingDOT # 191949Address: 4420 S. DecaturTruck Number: 44Las Vegas, NV 89103Phone Number: (702) 353-4355

I certify no hazardous waste or other regulated substance was knowingly introduced to the waste while in my custody. The waste transported in this vehicle is the waste identified above, to the best of my knowledge.

Ted Glastre
 Name of Authorized Agent

Ted Glastre
 Signature

9-30-10
 Date Delivered

DISPOSAL SITE INFORMATION

Site Name: Apex Regional LandfillPhone No. (702) 599-5920Address: 13550 U.S. Hwy 93 Las Vegas, NV

I hereby acknowledge receipt of the above described materials

[Signature]
 Name (Print or Type)

[Signature]
 Signature

10-1-10
 Date Received

81 Environmental Tech
13550 N Highway 93
Las Vegas, NV 89165

Ticket Type: INBOUND INVOICE

Ticket Number: 1523
Date: 10/01/2010
Time In: 12:44 am
Time Out: 1:11 am

Customer: 001011 - NGE, LLC c/o Northgate Environ Mgmt

Vehicle/Container: 44166A
Contract: Northgate Env. On Site Soils 3825 11
Comment: 3825 10 11244

Gross Weight: 123,700 LB Manual In
Tare Weight: 56,120 LB Manual Out
Net Weight: 67580 LB
Net Tons: 33.79

BOL: 11629

Origin	Yards	Material	Billing	Quantity
Not Applicable	0.00 YD	SW CONTAMINATED SOIL	33.79	TN

Driver: _____



Weighmaster: _____

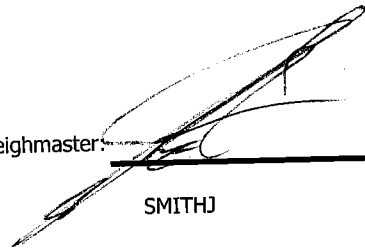

SMITHJ

Indemnification. Customer agrees, by signature above, to indemnify, hold harmless, and defend Republic Services, Inc., its subsidiaries, affiliates, employees, officers and directors from and against any and all liabilities, claims, penalties, forfeitures, suits and the costs and expenses incident thereto, including costs of defense, settlement, and reasonable attorney's fees, which may be incurred, as a result of death or injuries to any person, or damage to any property, contamination of or adverse effects on the environment, caused in whole or in part by the Customer, its employees, or subcontractors in disposing waste at this Facility. In the event Customer delivers Unacceptable Waste (as determined by Republic) Customer agrees to assume all expenses and obligations with the removal and/or resolution of any effects caused by the delivery of such Unacceptable Waste.

Indemnización. Cliente acuerda indemnizar, mantener inmune, y defender Republic Services, Inc., sus subsidiarios, compañías, divisiones, empleados, oficiales y directores contra de cualquiera y de todas responsabilidades, demandas, penas, pérdidas, juicios, pleitos y los costos incidente además, incluyendo costos de defensa, de acuerdo judicial, y de honorarios razonables del abogado, que pueden ser incurridos en, o como resultado de, la muerte o herida personal a cualquier persona, o daños a cualquier característica, propiedad, contaminación de la tierra o efectos ilícitos en esta Facilidad, causado entero o en parte por el cliente, sus empleados, o sus subcontratistas en botar basura en esta Facilidad. En el caso que el Cliente entrega, bota, basura (según lo determinado por Republic) en este Establecimiento basura inaceptable en los reglamentos de este Establecimiento, el Cliente se compromete asumir todos los costos y obligaciones con el retiro y/o la resolución de cualquier dano(s) causado por la entrega de tal basura inaceptable.



NON-HAZARDOUS WASTE MANIFEST

MANIFEST # 11629

GENERATOR INFORMATION

Generator Name: Tronox LLCAddress: P.O. Box 55City: Henderson County: ClarkState: NV Zip: 89009Site Location (if different): 560 W. Lake MeadHenderson, NV 89015 (702) 592-7727

CUSTOMER/BILLING INFORMATION

Billing Name: NGE LLC c/o Northgate Environment ManagementAddress: 300 Frank Ogawa Plaza, Ste 510City: Oakland County: AlamedaState: CA Zip: 94612

Republic Services Approval #	Description of Waste	Volume/Weight	Expiration Date	Container Type
38251011244	Soil for disposal		12-31-2011	Tractor with Dump Trailer(s)
	RZ- _____ # _____	33.79 TON		

*Attach Additional Sheet if necessary



I hereby certify that the above-described materials are non-hazardous wastes as defined by 40 CFR 261 or any applicable state law. Further, that the above named materials are properly classified, described, packaged, marked and labeled, and are in proper condition for transportation according to the applicable regulations of the Department of Transportation.

Susan Crowley 
 Generator/Authorized Agent Name Signature Date Shipped

TRANSPORTER INFORMATION

Transporter Name: Las Vegas PavingDOT # 191949Address: 4420 S. DecaturTruck Number: K002Las Vegas, NV 89103Phone Number: (702) 353-4355

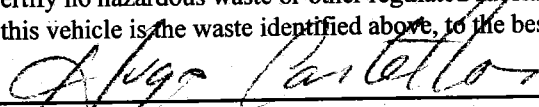
I certify no hazardous waste or other regulated substance was knowingly introduced to the waste while in my custody. The waste transported in this vehicle is the waste identified above, to the best of my knowledge.

  9-30-10
 Name of Authorized Agent Signature Date Delivered

DISPOSAL SITE INFORMATION

Site Name: Apex Regional LandfillPhone No. (702) 599-5920Address: 13550 U.S. Hwy 93 Las Vegas, NV

I hereby acknowledge receipt of the above described materials

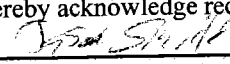
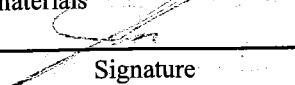
  10-1-10
 Name (Print or Type) Signature Date Received

81 Environmental Tech
13550 N Highway 93
Las Vegas, NV 89165

Ticket Type: INBOUND INVOICE

Ticket Number: 1524
Date: 10/01/2010
Time In: 12:51 am
Time Out: 1:16 am

Customer: 001011 - NGE, LLC c/o Northgate Environ Mgmt

Vehicle/Container: 86113P
Contract: Northgate Env. On Site Soils 3825 11
Comment: 3825 10 11244

Gross Weight: 128,840 LB Manual In
Tare Weight: 56,180 LB Manual Out
Net Weight: 72660 LB
Net Tons: 36.33

BOL: 11631

Origin	Yards	Material	Billing	Quantity
Not Applicable	0.00 YD	SW CONTAMINATED SOIL	36.33	TN

Driver:

J. A. H

Weighmaster:

SMITHJ

Indemnification. Customer agrees, by signature above, to indemnify, hold harmless, and defend Republic Services, Inc., its subsidiaries, affiliates, employees, officers and directors from and against any and all liabilities, claims, penalties, forfeitures, suits and the costs and expenses incident thereto, including costs of defense, settlement, and reasonable attorney's fees, which may be incurred, as a result of death or injuries to any person, or damage to any property, contamination of or adverse effects on the environment, caused in whole or in part by the Customer, its employees, or subcontractors in disposing waste at this Facility. In the event Customer delivers Unacceptable Waste (as determined by Republic) Customer agrees to assume all expenses and obligations with the removal and/or resolution of any effects caused by the delivery of such Unacceptable Waste.

Indemnización. Cliente acuerda indemnizar, mantener inmune, y defender Republic Services, Inc., sus subsidiarios, companias, divisiones, empleados, oficiales y directores contra de cualquiera y de todas responsabilidades, demandas, penas, pérdidas, juicios, pleitos y los costos incidente además, incluyendo costos de defensa, de acuerdo judicial, y de honorarios razonables del abogado, que pueden ser incurridos en, o como resultado de, la muerte o herida personal a cualquier persona, o daños a cualquier característica, propiedad, contaminación de la tierra o efectos ilicitos en esta Facilidat. En el caso que el Cliente entrega, bota, basura (según lo determinado por Republic) en este Establecimiento basura inaceptable en los reglamentos de este Establecimiento, el Cliente se compromete asumir todos los costos y obligaciones con el retiro y/o la resolución de cualquier dano(s) causado por la entrega de tal basura inaceptable.



NON-HAZARDOUS WASTE MANIFEST

MANIFEST # 11631

GENERATOR INFORMATION

Generator Name: Tronox LLC

Address: P.O. Box 55

City: Henderson County: Clark

State: NV Zip: 89009

Site Location (if different): 560 W. Lake Mead

Henderson, NV 89015 (702) 592-7727

CUSTOMER/BILLING INFORMATION

Billing Name: NGE LLC c/o Northgate Environment Management

Address: 300 Frank Ogawa Plaza, Ste 510

City: Oakland County: Alameda

State: CA Zip: 94612

Table with 5 columns: Republic Services Approval #, Description of Waste, Volume/Weight, Expiration Date, Container Type. Row 1: 38251011244, Soil for disposal, 36-33-10, 12-31-2011, Tractor with Dump Trailer(s).

*Attach Additional Sheet if necessary

I hereby certify that the above-described materials are non-hazardous wastes as defined by 40 CFR 261 or any applicable state law. Further, that the above named materials are properly classified, described, packaged, marked and labeled, and are in proper condition for transportation according to the applicable regulations of the Department of Transportation.

Susan Crowley (Name), [Signature] (Signature), Date Shipped

TRANSPORTER INFORMATION

Transporter Name: Las Vegas Paving

DOT # 191949

Address: 4420 S. Decatur

Truck Number: KMJ A 19/7

Las Vegas, NV 89103

Phone Number: (702) 353-4355

I certify no hazardous waste or other regulated substance was knowingly introduced to the waste while in my custody. The waste transported in this vehicle is the waste identified above, to the best of my knowledge.

ALBERTO HERRERA (Name), [Signature] (Signature), SEP 30, 2010 (Date Delivered)

DISPOSAL SITE INFORMATION

Site Name: Apex Regional Landfill

Phone No. (702) 599-5920

Address: 13550 U.S. Hwy 93 Las Vegas, NV

I hereby acknowledge receipt of the above described materials

[Signature] (Signature), Date Received

81 Environmental Tech
13550 N Highway 93
Las Vegas, NV 89165

Ticket Type: INBOUND INVOICE

Ticket Number: 1525
Date: 10/01/2010
Time In: 12:55 am
Time Out: 1:19 am

Customer: 001011 - NGE, LLC c/o Northgate Environ Mgmt

Vehicle/Container: 86053P
Contract: Northgate Env. On Site Soils 3825 11
Comment: 3825 10 11244

Gross Weight: 125,320 LB Manual In
Tare Weight: 54,520 LB Manual Out
Net Weight: 70800 LB
Net Tons: 35.40

BOL: 11633

Origin	Yards	Material	Billing	Quantity
Not Applicable	0.00 YD	SW CONTAMINATED SOIL	35.40	TN

Driver: _____



Weighmaster: _____

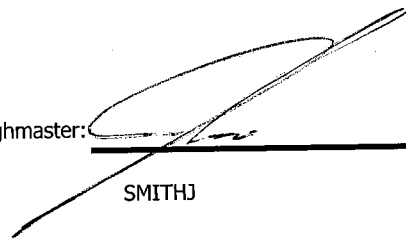

SMITHJ

Indemnification. Customer agrees, by signature above, to indemnify, hold harmless, and defend Republic Services, Inc., its subsidiaries, affiliates, employees, officers and directors from and against any and all liabilities, claims, penalties, forfeitures, suits and the costs and expenses incident thereto, including costs of defense, settlement, and reasonable attorney's fees, which may be incurred, as a result of death or injuries to any person, or damage to any property, contamination of or adverse effects on the environment, caused in whole or in part by the Customer, its employees, or subcontractors in disposing waste at this Facility. In the event Customer delivers Unacceptable Waste (as determined by Republic) Customer agrees to assume all expenses and obligations with the removal and/or resolution of any effects caused by the delivery of such Unacceptable Waste.

Indemnización. Cliente acuerda indemnizar, mantener inmune, y defender Republic Services, Inc., sus subsidiarios, compañías, divisiones, empleados, oficiales y directores contra de cualquiera y de todas responsabilidades, demandas, penas, pérdidas, juicios, pleitos y los costos incidente además, incluyendo costos de defensa, de acuerdo judicial, y de honorarios razonables del abogado, que pueden ser incurridos en, o como resultado de, la muerte o herida personal a cualquier persona, o daños a cualquier característica, propiedad, contaminación de la tierra o efectos ilícitos en esta Facilidad, causado entero o en parte por el cliente, sus empleados, o sus subcontratistas en botar basura en esta Facilidad. En el caso que el Cliente entrega, bota, basura (según lo determinado por Republic) en este Establecimiento basura inaceptable en los reglamentos de este Establecimiento, el Cliente se compromete asumir todos los costos y obligaciones con el retiro y/o la resolución de cualquier dano(s) causado por la entrega de tal basura inaceptable.



NON-HAZARDOUS WASTE MANIFEST

MANIFEST # 11633

GENERATOR INFORMATION

Generator Name: Tronox LLC

Address: P.O. Box 55

City: Henderson County: Clark

State: NV Zip: 89009

Site Location (if different): 560 W. Lake Mead

Henderson, NV 89015 (702) 592-7727

CUSTOMER/BILLING INFORMATION

Billing Name: NGE LLC c/o Northgate Environment Management

Address: 300 Frank Ogawa Plaza, Ste 510

City: Oakland County: Alameda

State: CA Zip: 94612

Republic Services Approval #	Description of Waste	Volume/Weight	Expiration Date	Container Type
38251011244	Soil for disposal		12-31-2011	Tractor with Dump Trailer(s)
	RZ- _____ # _____	35.40 TON		

*Attach Additional Sheet if necessary

I hereby certify that the above-described materials are non-hazardous wastes as defined by 40 CFR 261 or any applicable state law. Further, that the above named materials are properly classified, described, packaged, marked and labeled, and are in proper condition for transportation according to the applicable regulations of the Department of Transportation.

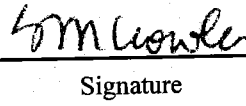
Susan Crowley  _____
 Generator/Authorized Agent Name Signature Date Shipped

TRANSPORTER INFORMATION

Transporter Name: Las Vegas Paving

DOT # 191949

Address: 4420 S. Decatur

Truck Number: 261

Las Vegas, NV 89103

Phone Number: (702) 353-4355

I certify no hazardous waste or other regulated substance was knowingly introduced to the waste while in my custody. The waste transported in this vehicle is the waste identified above, to the best of my knowledge.

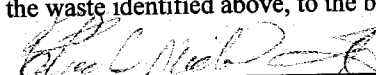
 Patricia Jones _____
 Name of Authorized Agent Signature Date Delivered 30 SEP 10

DISPOSAL SITE INFORMATION

Site Name: Apex Regional Landfill

Phone No. (702) 599-5920

Address: 13550 U.S. Hwy 93 Las Vegas, NV

I hereby acknowledge receipt of the above described materials

Bob Smith  _____
 Name (Print or Type) Signature Date Received 10-1-10

81 Environmental Tech
13550 N Highway 93
Las Vegas, NV 89165

Ticket Type: INBOUND INVOICE

Ticket Number: 1526
Date: 10/01/2010
Time In: 12:59 am
Time Out: 1:22 am

Customer: 001011 - NGE, LLC c/o Northgate Environ Mgmt

Vehicle/Container: 81494P
Contract: Northgate Env. On Site Soils 3825 11
Comment: 3825 10 11244

Gross Weight: 121,920 LB Manual In
Tare Weight: 50,160 LB Manual Out
Net Weight: 71,760 LB
Net Tons: 35.88

BOL: 11634

Origin	Yards	Material	Billing	Quantity
Not Applicable	0.00 YD	SW CONTAMINATED SOIL	35.88	TN

Driver: _____

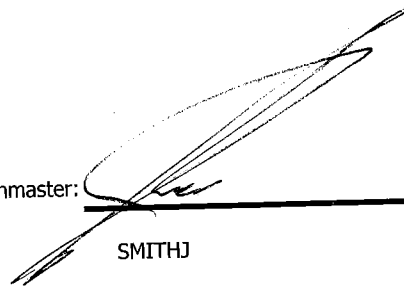

Weighmaster: _____

SMITHJ

Indemnification. Customer agrees, by signature above, to indemnify, hold harmless, and defend Republic Services, Inc., its subsidiaries, affiliates, employees, officers and directors from and against any and all liabilities, claims, penalties, forfeitures, suits and the costs and expenses incident thereto, including costs of defense, settlement, and reasonable attorney's fees, which may be incurred, as a result of death or injuries to any person, or damage to any property, contamination of or adverse effects on the environment, caused in whole or in part by the Customer, its employees, or subcontractors in disposing waste at this Facility. In the event Customer delivers Unacceptable Waste (as determined by Republic) Customer agrees to assume all expenses and obligations with the removal and/or resolution of any effects caused by the delivery of such Unacceptable Waste.

Indemnización. Cliente acuerda indemnizar, mantener inmune, y defender Republic Services, Inc., sus subsidiarios, compañías, divisiones, empleados, oficiales y directores contra de cualquiera y de todas responsabilidades, demandas, penas, pérdidas, juicios, pleitos y los costos incidente además, incluyendo costos de defensa, de acuerdo judicial, y de honorarios razonables del abogado, que pueden ser incurridos en, o como resultado de, la muerte o herida personal a cualquier persona, o daños a cualquier característica, propiedad, contaminación de la tierra o efectos ilícitos en esta Facilidad, causado entero o en parte por el cliente, sus empleados, o sus subcontratistas en botar basura en esta Facilidad. En el caso que el Cliente entrega, bota, basura (según lo determinado por Republic) en este Establecimiento basura inaceptable en los reglamentos de este Establecimiento, el Cliente se compromete asumir todos los costos y obligaciones con el retiro y/o la resolución de cualquier dano(s) causado por la entrega de tal basura inaceptable.



NON-HAZARDOUS WASTE MANIFEST

MANIFEST # 11634

GENERATOR INFORMATION

Generator Name: Tronox LLC
Address: P.O. Box 55
City: Henderson County: Clark
State: NV Zip: 89009
Site Location (if different): 560 W. Lake Mead
Henderson, NV 89015 (702) 592-7727

CUSTOMER/BILLING INFORMATION

Billing Name: NGE LLC c/o Northgate Environment Management
Address: 300 Frank Ogawa Plaza, Ste 510
City: Oakland County: Alameda
State: CA Zip: 94612

Table with 5 columns: Republic Services Approval #, Description of Waste, Volume/Weight, Expiration Date, Container Type. Row 1: 38251011244, Soil for disposal, 35.88 TON, 12-31-2011, Tractor with Dump Trailer(s)

*Attach Additional Sheet if necessary

I hereby certify that the above-described materials are non-hazardous wastes as defined by 40 CFR 261 or any applicable state law. Further, that the above named materials are properly classified, described, packaged, marked and labeled, and are in proper condition for transportation according to the applicable regulations of the Department of Transportation.

Susan Crowley (Signature) Date Shipped
Generator/Authorized Agent Name Signature Date Shipped

TRANSPORTER INFORMATION

Transporter Name: Las Vegas Paving DOT # 191949
Address: 4420 S. Decatur Truck Number: 125
Las Vegas, NV 89103 Phone Number: (702) 353-4355

I certify no hazardous waste or other regulated substance was knowingly introduced to the waste while in my custody. The waste transported in this vehicle is the waste identified above, to the best of my knowledge.

Calvin Paguyo (Signature) Date Delivered: 9/30/10
Name of Authorized Agent Signature Date Delivered

DISPOSAL SITE INFORMATION

Site Name: Apex Regional Landfill Phone No. (702) 599-5920
Address: 13550 U.S. Hwy 93 Las Vegas, NV

I hereby acknowledge receipt of the above described materials
Name (Print or Type) Signature Date Received: 10-1-10

81 Environmental Tech
13550 N Highway 93
Las Vegas, NV 89165

Ticket Type: INBOUND INVOICE

Ticket Number: 1527
Date: 10/01/2010
Time In: 12:53 am
Time Out: 1:25 am

Customer: 001011 - NGE, LLC c/o Northgate Environ Mgmt

Vehicle/Container: 20915A
Contract: Northgate Env. On Site Soils 3825 11
Comment: 3825 10 11244

Gross Weight: 126,320 LB Manual In
Tare Weight: 52,580 LB Manual Out
Net Weight: 73740 LB
Net Tons: 36.87

BOL: 11632

Origin	Yards	Material	Billing	Quantity
Not Applicable	0.00 YD	SW CONTAMINATED SOIL	36.87	TN

Driver:

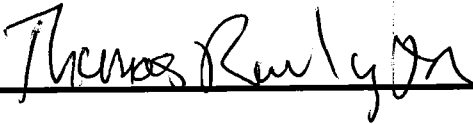

Weighmaster:



SMITHJ

Indemnification. Customer agrees, by signature above, to indemnify, hold harmless, and defend Republic Services, Inc., its subsidiaries, affiliates, employees, officers and directors from and against any and all liabilities, claims, penalties, forfeitures, suits and the costs and expenses incident thereto, including costs of defense, settlement, and reasonable attorney's fees, which may be incurred, as a result of death or injuries to any person, or damage to any property, contamination of or adverse effects on the environment, caused in whole or in part by the Customer, its employees, or subcontractors in disposing waste at this Facility. In the event Customer delivers Unacceptable Waste (as determined by Republic) Customer agrees to assume all expenses and obligations with the removal and/or resolution of any effects caused by the delivery of such Unacceptable Waste.

Indemnización. Cliente acuerda indemnizar, mantener inmune, y defender Republic Services, Inc., sus subsidiarios, compañías, divisiones, empleados, oficiales y directores contra de cualquiera y de todas responsabilidades, demandas, penas, pérdidas, juicios, pleitos y los costos incidente además, incluyendo costos de defensa, de acuerdo judicial, y de honorarios razonables del abogado, que pueden ser incurridos en, o como resultado de, la muerte o herida personal a cualquier persona, o daños a cualquier característica, propiedad, contaminación de la tierra o efectos ilícitos en esta Facilidad, causado entero o en parte por el cliente, sus empleados, o sus subcontratistas en botar basura en esta Facilidad. En el caso que el Cliente entrega, bota, basura (según lo determinado por Republic) en este Establecimiento basura inaceptable en los reglamentos de este Establecimiento, el Cliente se compromete asumir todos los costos y obligaciones con el retiro y/o la resolución de cualquier dano(s) causado por la entrega de tal basura inaceptable.



NON-HAZARDOUS WASTE MANIFEST

MANIFEST # 11632

GENERATOR INFORMATION

Generator Name: Tronox LLCAddress: P.O. Box 55City: Henderson County: ClarkState: NV Zip: 89009Site Location (if different): 560 W. Lake Mead
Henderson, NV 89015 (702) 592-7727

CUSTOMER/BILLING INFORMATION

Billing Name: NGE LLC c/o Northgate Environment ManagementAddress: 300 Frank Ogawa Plaza, Ste 510City: Oakland County: AlamedaState: CA Zip: 94612

Republic Services Approval #	Description of Waste	Volume/Weight	Expiration Date	Container Type
38251011244	Soil for disposal		12-31-2011	Tractor with Dump Trailer(s)
	RZ-_____#_____	36.87 TON		

*Attach Additional Sheet if necessary

I hereby certify that the above-described materials are non-hazardous wastes as defined by 40 CFR 261 or any applicable state law. Further, that the above named materials are properly classified, described, packaged, marked and labeled, and are in proper condition for transportation according to the applicable regulations of the Department of Transportation.

Susan Crowley
Generator/Authorized Agent Name

Tom Crowley
Signature

Date Shipped

TRANSPORTER INFORMATION

Transporter Name: Las Vegas PavingDOT # 191949Address: 4420 S. DecaturTruck Number: 00Las Vegas, NV 89103Phone Number: (702) 353-4355

I certify no hazardous waste or other regulated substance was knowingly introduced to the waste while in my custody. The waste transported in this vehicle is the waste identified above, to the best of my knowledge.

Tom Rawley Jr
Name of Authorized Agent

Thomas Rawley Jr
Signature

10-1-10
Date Delivered

DISPOSAL SITE INFORMATION

Site Name: Apex Regional LandfillPhone No. (702) 599-5920Address: 13550 U.S. Hwy 93 Las Vegas, NV

I hereby acknowledge receipt of the above described materials

Jessie Smith
Name (Print or Type)

Jessie Smith
Signature

10-1-10
Date Received

81 Environmental Tech
13550 N Highway 93
Las Vegas, NV 89165

Ticket Type: INBOUND INVOICE

Ticket Number: 1528
Date: 10/01/2010
Time In: 1:05 am
Time Out: 1:31 am

Customer: 001011 - NGE, LLC c/o Northgate Environ Mgmt

Vehicle/Container: 81460P
Contract: Northgate Env. On Site Soils 3825 11
Comment: 3825 10 11244

Gross Weight: 125,800 LB Manual In
Tare Weight: 51,920 LB Manual Out
Net Weight: 73880 LB
Net Tons: 36.94

BOL: 11635

Origin	Yards	Material	Billing	Quantity
Not Applicable	0.00 YD	SW CONTAMINATED SOIL	36.94	TN

Driver: _____

Weighmaster: _____

SMITHJ

Indemnification. Customer agrees, by signature above, to indemnify, hold harmless, and defend Republic Services, Inc., its subsidiaries, affiliates, employees, officers and directors from and against any and all liabilities, claims, penalties, forfeitures, suits and the costs and expenses incident thereto, including costs of defense, settlement, and reasonable attorney's fees, which may be incurred, as a result of death or injuries to any person, or damage to any property, contamination of or adverse effects on the environment, caused in whole or in part by the Customer, its employees, or subcontractors in disposing waste at this Facility. In the event Customer delivers Unacceptable Waste (as determined by Republic) Customer agrees to assume all expenses and obligations with the removal and/or resolution of any effects caused by the delivery of such Unacceptable Waste.

Indemnización. Cliente acuerda indemnizar, mantener inmune, y defender Republic Services, Inc., sus subsidiarios, compañías, divisiones, empleados, oficiales y directores contra de cualquiera y de todas responsabilidades, demandas, penas, pérdidas, juicios, pleitos y los costos incidente además, incluyendo costos de defensa, de acuerdo judicial, y de honorarios razonables del abogado, que pueden ser incurridos en, o como resultado de, la muerte o herida personal a cualquier persona, o daños a cualquier característica, propiedad, contaminación de la tierra o efectos ilícitos en esta Facilidad, causado entero o en parte por el cliente, sus empleados, o sus subcontratistas en botar basura en esta Facilidad. En el caso que el Cliente entrega, bota, basura (según lo determinado por Republic) en este Establecimiento basura inaceptable en los reglamentos de este Establecimiento, el Cliente se compromete asumir todos los costos y obligaciones con el retiro y/o la resolución de cualquier dano(s) causado por la entrega de tal basura inaceptable.



NON-HAZARDOUS WASTE MANIFEST

MANIFEST # 11635

GENERATOR INFORMATION

Generator Name: Tronox LLC

Address: P.O. Box 55

City: Henderson County: Clark

State: NV Zip: 89009

Site Location (if different): 560 W. Lake Mead
Henderson, NV 89015 (702) 592-7727

CUSTOMER/BILLING INFORMATION

Billing Name: NGE LLC c/o Northgate Environment Management

Address: 300 Frank Ogawa Plaza, Ste 510

City: Oakland County: Alameda

State: CA Zip: 94612

Republic Services Approval #	Description of Waste	Volume/Weight	Expiration Date	Container Type
38251011244	Soil for disposal		12-31-2011	Tractor with Dump Trailer(s)
	RZ- _____ # _____	<u>36.94 TON</u>		

*Attach Additional Sheet if necessary

I hereby certify that the above-described materials are non-hazardous wastes as defined by 40 CFR 261 or any applicable state law. Further, that the above named materials are properly classified, described, packaged, marked and labeled, and are in proper condition for transportation according to the applicable regulations of the Department of Transportation.

Susan Crowley
Generator/Authorized Agent Name

[Signature]
Signature

Date Shipped

TRANSPORTER INFORMATION

Transporter Name: Las Vegas Paving

DOT # 191949

Address: 4420 S. Decatur

Truck Number: 27

Las Vegas, NV 89103

Phone Number: (702) 353-4355

I certify no hazardous waste or other regulated substance was knowingly introduced to the waste while in my custody. The waste transported in this vehicle is the waste identified above, to the best of my knowledge.

Daniel Cardenas
Name of Authorized Agent

[Signature]
Signature

9/30/2010
Date Delivered

DISPOSAL SITE INFORMATION

Site Name: Apex Regional Landfill

Phone No. (702) 599-5920

Address: 13550 U.S. Hwy 93 Las Vegas, NV

I hereby acknowledge receipt of the above described materials

[Signature]
Name (Print or Type)

[Signature]
Signature

10-1-10
Date Received

81 Environmental Tech
13550 N Highway 93
Las Vegas, NV 89165

Ticket Type: INBOUND INVOICE

Ticket Number: 1529
Date: 10/01/2010
Time In: 1:06 am
Time Out: 1:32 am

Customer: 001011 - NGE, LLC c/o Northgate Environ Mgmt

Vehicle/Container: 76811P
Contract: Northgate Env. On Site Soils 3825 10
Comment: 3825 10 11244

Gross Weight: 127,640 LB Manual In
Tare Weight: 52,780 LB Manual Out
Net Weight: 74860 LB
Net Tons: 37.43

BOL: 11636

Origin	Yards	Material	Billing	Quantity
Not Applicable	0.00 YD	SW CONTAMINATED SOIL	37.43	TN

Driver: _____

Weighmaster: _____

SMITHJ

Indemnification. Customer agrees, by signature above, to indemnify, hold harmless, and defend Republic Services, Inc., its subsidiaries, affiliates, employees, officers and directors from and against any and all liabilities, claims, penalties, forfeitures, suits and the costs and expenses incident thereto, including costs of defense, settlement, and reasonable attorney's fees, which may be incurred, as a result of death or injuries to any person, or damage to any property, contamination of or adverse effects on the environment, caused in whole or in part by the Customer, its employees, or subcontractors in disposing waste at this Facility. In the event Customer delivers Unacceptable Waste (as determined by Republic) Customer agrees to assume all expenses and obligations with the removal and/or resolution of any effects caused by the delivery of such Unacceptable Waste.

Indemnización. Cliente acuerda indemnizar, mantener inmune, y defender Republic Services, Inc., sus subsidiarios, compañías, divisiones, empleados, oficiales y directores contra de cualquiera y de todas responsabilidades, demandas, penas, pérdidas, juicios, pleitos y los costos incidente además, incluyendo costos de defensa, de acuerdo judicial, y de honorarios razonables del abogado, que pueden ser incurridos en, o como resultado de, la muerte o herida personal a cualquier persona, o daños a cualquier característica, propiedad, contaminación de la tierra o efectos ilícitos en esta Facilidad, causado entero o en parte por el cliente, sus empleados, o sus subcontratistas en botar basura en esta Facilidad. En el caso que el Cliente entrega, bota, basura (según lo determinado por Republic) en este Establecimiento basura inaceptable en los reglamentos de este Establecimiento, el Cliente se compromete asumir todos los costos y obligaciones con el retiro y/o la resolución de cualquier dano(s) causado por la entrega de tal basura inaceptable.



NON-HAZARDOUS WASTE MANIFEST

MANIFEST # 11536

GENERATOR INFORMATION

Generator Name: Tronox LLC

Address: P.O. Box 55

City: Henderson County: Clark

State: NV Zip: 89009

Site Location (if different): 560 W. Lake Mead

Henderson, NV 89015 (702) 592-7727

CUSTOMER/BILLING INFORMATION

Billing Name: NGE LLC c/o Northgate Environment Management

Address: 300 Frank Ogawa Plaza, Ste 510

City: Oakland County: Alameda

State: CA Zip: 94612

Table with 5 columns: Republic Services Approval #, Description of Waste, Volume/Weight, Expiration Date, Container Type. Row 1: 38251011244, Soil for disposal, 37.43 TN, 12-31-2011, Tractor with Dump Trailer(s).

*Attach Additional Sheet if necessary

I hereby certify that the above-described materials are non-hazardous wastes as defined by 40 CFR 261 or any applicable state law. Further, that the above named materials are properly classified, described, packaged, marked and labeled, and are in proper condition for transportation according to the applicable regulations of the Department of Transportation.

Susan Crowley (Name), Tom Crowley (Signature), Date Shipped

TRANSPORTER INFORMATION

Transporter Name: Las Vegas Paving DOT # 191949
Address: 4420 S. Decatur Truck Number:
Las Vegas, NV 89103 Phone Number: (702) 353-4355

I certify no hazardous waste or other regulated substance was knowingly introduced to the waste while in my custody. The waste transported in this vehicle is the waste identified above, to the best of my knowledge.

STEVE HAYES (Name), Signature, Date Delivered 9-30-01

DISPOSAL SITE INFORMATION

Site Name: Apex Regional Landfill Phone No. (702) 599-5920
Address: 13550 U.S. Hwy 93 Las Vegas, NV

I hereby acknowledge receipt of the above described materials
Name (Print or Type), Signature, Date Received 10-1-01

81 Environmental Tech
13550 N Highway 93
Las Vegas, NV 89165

Ticket Type: INBOUND INVOICE

Ticket Number: 1530
Date: 10/01/2010
Time In: 1:15 am
Time Out: 1:37 am

Customer: 001011 - NGE, LLC c/o Northgate Environ Mgmt

Vehicle/Container: 85940P
Contract: Northgate Env. On Site Soils 3825 11
Comment: 3825 10 11244

Gross Weight: 122,440 LB Manual In
Tare Weight: 54,020 LB Manual Out
Net Weight: 68420 LB
Net Tons: 34.21

BOL: 11638

Origin	Yards	Material	Billing	Quantity
Not Applicable	0.00 YD	SW CONTAMINATED SOIL	34.21	TN

Driver:

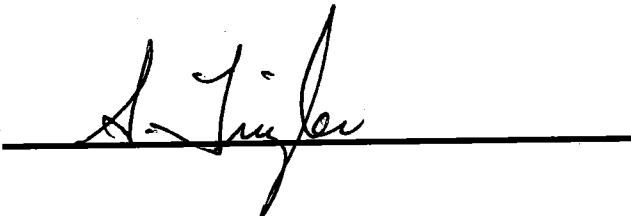

Weighmaster:

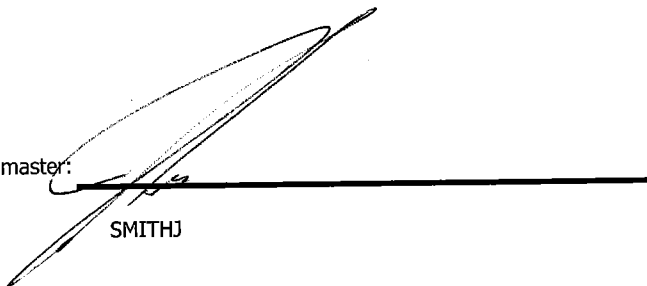

SMITHJ

Indemnification. Customer agrees, by signature above, to indemnify, hold harmless, and defend Republic Services, Inc., its subsidiaries, affiliates, employees, officers and directors from and against any and all liabilities, claims, penalties, forfeitures, suits and the costs and expenses incident thereto, including costs of defense, settlement, and reasonable attorney's fees, which may be incurred, as a result of death or injuries to any person, or damage to any property, contamination of or adverse effects on the environment, caused in whole or in part by the Customer, its employees, or subcontractors in disposing waste at this Facility. In the event Customer delivers Unacceptable Waste (as determined by Republic) Customer agrees to assume all expenses and obligations with the removal and/or resolution of any effects caused by the delivery of such Unacceptable Waste.

Indemnización. Cliente acuerda indemnizar, mantener inune, y defender Republic Services, Inc., sus subsidiarios, companias, divisiones, empleados, oficiales y directores contra de cualquiera y de todas responsabilidades, demandas, penas, pérdidas, juicios, pleitos y los costos incidente además, incluyendo costos de defensa, de acuerdo judicial, y de honorarios razonables del abogado, que pueden ser incurridos en, o como resultado de, la muerte o herida personal a cualquier persona, o daños a cualquier característica, propiedad, contaminación de la tierra o efectos ilicitos en esta Facilidat, causado entero o en parte por el cliente, sus empleados, o sus subcontratistas en botar basura en esta Facilidat. En el caso que el Cliente entrega, bota, basura (según lo determinado por Republic) en este Establecimiento basura inaceptable en los reglamentos de este Establecimiento, el Cliente se compromete asumir todos los costos y obligaciones con el retiro y/o la resolución de cualquier dano(s) causado por la entrega de tal basura inaceptable.



NON-HAZARDOUS WASTE MANIFEST

MANIFEST # 11638

GENERATOR INFORMATION

Generator Name: Tronox LLC

Address: P.O. Box 55

City: Henderson County: Clark

State: NV Zip: 89009

Site Location (if different): 560 W. Lake Mead

Henderson, NV 89015 (702) 592-7727

CUSTOMER/BILLING INFORMATION

Billing Name: NGE LLC c/o Northgate Environment Management

Address: 300 Frank Ogawa Plaza, Ste 510

City: Oakland County: Alameda

State: CA Zip: 94612

Republic Services Approval #	Description of Waste	Volume/Weight	Expiration Date	Container Type
38251011244	Soil for disposal		12-31-2011	Tractor with Dump Trailer(s)
	RZ- _____ # _____	34.21 T0		

*Attach Additional Sheet if necessary

I hereby certify that the above-described materials are non-hazardous wastes as defined by 40 CFR 261 or any applicable state law. Further, that the above named materials are properly classified, described, packaged, marked and labeled, and are in proper condition for transportation according to the applicable regulations of the Department of Transportation.

Susan Crowley (Signature) Date Shipped

TRANSPORTER INFORMATION

Transporter Name: Las Vegas Paving

DOT # 191949

Address: 4420 S. Decatur

Truck Number: 06

Las Vegas, NV 89103

Phone Number: (702) 353-4355

I certify no hazardous waste or other regulated substance was knowingly introduced to the waste while in my custody. The waste transported in this vehicle is the waste identified above, to the best of my knowledge.

TRIGLER, STEVE (Signature) Date Delivered 9.30.10

DISPOSAL SITE INFORMATION

Site Name: Apex Regional Landfill

Phone No. (702) 599-5920

Address: 13550 U.S. Hwy 93 Las Vegas, NV

I hereby acknowledge receipt of the above described materials

JOHN SMITH (Signature) Date Received 10.1.10

81 Environmental Tech
13550 N Highway 93
Las Vegas, NV 89165

Ticket Type: INBOUND INVOICE

Ticket Number: 1531
Date: 10/01/2010
Time In: 1:17 am
Time Out: 1:37 am

Customer: 001011 - NGE, LLC c/o Northgate Environ Mgmt

Vehicle/Container: 84598P

Contract: Northgate Env. On Site Soils 3825 10
Comment: 3825 10 11244

Gross Weight: 116,620 LB Manual In
Tare Weight: 52,180 LB Manual Out
Net Weight: 64440 LB
Net Tons: 32.22

BOL: 11639

Origin	Yards	Material	Billing	Quantity
Not Applicable	0.00 YD	SW CONTAMINATED SOIL	32.22	TN

Driver: _____

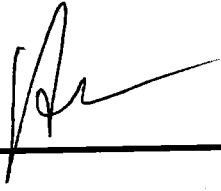

Weighmaster: _____

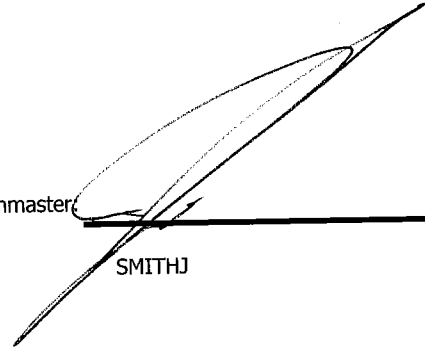

SMITHJ

Indemnification. Customer agrees, by signature above, to indemnify, hold harmless, and defend Republic Services, Inc., its subsidiaries, affiliates, employees, officers and directors from and against any and all liabilities, claims, penalties, forfeitures, suits and the costs and expenses incident thereto, including costs of defense, settlement, and reasonable attorney's fees, which may be incurred, as a result of death or injuries to any person, or damage to any property, contamination of or adverse effects on the environment, caused in whole or in part by the Customer, its employees, or subcontractors in disposing waste at this Facility. In the event Customer delivers Unacceptable Waste (as determined by Republic) Customer agrees to assume all expenses and obligations with the removal and/or resolution of any effects caused by the delivery of such Unacceptable Waste.

Indemnización. Cliente acuerda indemnizar, mantener inmune, y defender Republic Services, Inc., sus subsidiarios, compañías, divisiones, empleados, oficiales y directores contra de cualquiera y de todas responsabilidades, demandas, penas, pérdidas, juicios, pleitos y los costos incidente además, incluyendo costos de defensa, de acuerdo judicial, y de honorarios razonables del abogado, que pueden ser incurridos en, o como resultado de, la muerte o herida personal a cualquier persona, o daños a cualquier característica, propiedad, contaminación de la tierra o efectos ilícitos en esta Facilidad, causado entero o en parte por el cliente, sus empleados, o sus subcontratistas en botar basura en esta Facilidad. En el caso que el Cliente entrega, bota, basura (según lo determinado por Republic) en este Establecimiento basura inaceptable en los reglamentos de este Establecimiento, el Cliente se compromete asumir todos los costos y obligaciones con el retiro y/o la resolución de cualquier dano(s) causado por la entrega de tal basura inaceptable.



NON-HAZARDOUS WASTE MANIFEST

MANIFEST # 11639

GENERATOR INFORMATION

Generator Name: Tronox LLC
 Address: P.O. Box 55
 City: Henderson County: Clark
 State: NV Zip: 89009
 Site Location (if different): 560 W. Lake Mead
Henderson, NV 89015 (702) 592-7727

CUSTOMER/BILLING INFORMATION

Billing Name: NGE LLC c/o Northgate Environment Management
 Address: 300 Frank Ogawa Plaza, Ste 510
 City: Oakland County: Alameda
 State: CA Zip: 94612

Republic Services Approval #	Description of Waste	Volume/Weight	Expiration Date	Container Type
38251011244	Soil for disposal		12-31-2011	Tractor with Dump Trailer(s)
	RZ- _____ # _____	32.22 TW		

*Attach Additional Sheet if necessary

I hereby certify that the above-described materials are non-hazardous wastes as defined by 40 CFR 261 or any applicable state law. Further, that the above named materials are properly classified, described, packaged, marked and labeled, and are in proper condition for transportation according to the applicable regulations of the Department of Transportation.

Susan Crowley Tom Crowley _____
 Generator/Authorized Agent Name Signature Date Shipped

TRANSPORTER INFORMATION

Transporter Name: Las Vegas Paving DOT # 191949
 Address: 4420 S. Decatur Truck Number: 28
Las Vegas, NV 89103 Phone Number: (702) 353-4355

I certify no hazardous waste or other regulated substance was knowingly introduced to the waste while in my custody. The waste transported in this vehicle is the waste identified above, to the best of my knowledge.

KRANICE [Signature] 10/1-10
 Name of Authorized Agent Signature Date Delivered

DISPOSAL SITE INFORMATION

Site Name: Apex Regional Landfill Phone No. (702) 599-5920
 Address: 13550 U.S. Hwy 93 Las Vegas, NV

I hereby acknowledge receipt of the above described materials [Signature] 10-1-10
 Name (Print or Type) Signature Date Received

81 Environmental Tech
13550 N Highway 93
Las Vegas, NV 89165

Ticket Type: INBOUND INVOICE

Ticket Number: 1532
Date: 10/01/2010
Time In: 1:15 am
Time Out: 1:42 am

Customer: 001011 - NGE, LLC c/o Northgate Environ Mgmt

Vehicle/Container: 68263P
Contract: Northgate Env. On Site Soils 3825 11
Comment: 3825 10 11244

Gross Weight: 123,340 LB Manual In
Tare Weight: 54,200 LB Manual Out
Net Weight: 69140 LB
Net Tons: 34.57

BOL: 11637

Origin	Yards	Material	Billing	Quantity
Not Applicable	0.00 YD	SW CONTAMINATED SOIL	34.57	TN

Driver:

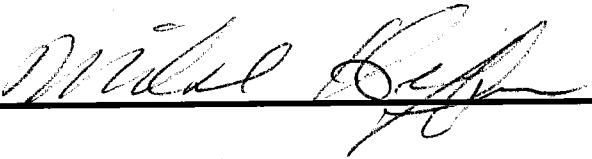

Weighmaster:

SMITHJ

Indemnification. Customer agrees, by signature above, to indemnify, hold harmless, and defend Republic Services, Inc., its subsidiaries, affiliates, employees, officers and directors from and against any and all liabilities, claims, penalties, forfeitures, suits and the costs and expenses incident thereto, including costs of defense, settlement, and reasonable attorney's fees, which may be incurred, as a result of death or injuries to any person, or damage to any property, contamination of or adverse effects on the environment, caused in whole or in part by the Customer, its employees, or subcontractors in disposing waste at this Facility. In the event Customer delivers Unacceptable Waste (as determined by Republic) Customer agrees to assume all expenses and obligations with the removal and/or resolution of any effects caused by the delivery of such Unacceptable Waste.

Indemnización. Cliente acuerda indemnizar, mantener inmune, y defender Republic Services, Inc., sus subsidiarios, compañías, divisiones, empleados, oficiales y directores contra de cualquiera y de todas responsabilidades, demandas, penas, pérdidas, juicios, pleitos y los costos incidente además, incluyendo costos de defensa, de acuerdo judicial, y de honorarios razonables del abogado, que pueden ser incurridos en, o como resultado de, la muerte o herida personal a cualquier persona, o daños a cualquier característica, propiedad, contaminación de la tierra o efectos ilícitos en esta Facilidad, causado entero o en parte por el cliente, sus empleados, o sus subcontratistas en botar basura en esta Facilidad. En el caso que el Cliente entrega, bota, basura (según lo determinado por Republic) en este Establecimiento basura inaceptable en los reglamentos de este Establecimiento, el Cliente se compromete asumir todos los costos y obligaciones con el retiro y/o la resolución de cualquier dano(s) causado por la entrega de tal basura inaceptable.



NON-HAZARDOUS WASTE MANIFEST

MANIFEST # 11637

GENERATOR INFORMATION

Generator Name: Tronox LLC

Address: P.O. Box 55

City: Henderson County: Clark

State: NV Zip: 89009

Site Location (if different): 560 W. Lake Mead

Henderson, NV 89015 (702) 592-7727

CUSTOMER/BILLING INFORMATION

Billing Name: NGE LLC c/o Northgate Environment Management

Address: 300 Frank Ogawa Plaza, Ste 510

City: Oakland County: Alameda

State: CA Zip: 94612

Republic Services Approval #	Description of Waste	Volume/Weight	Expiration Date	Container Type
38251011244	Soil for disposal		12-31-2011	Tractor with Dump Trailer(s)
	RZ- _____ # _____	34.57 76		

*Attach Additional Sheet if necessary

I hereby certify that the above-described materials are non-hazardous wastes as defined by 40 CFR 261 or any applicable state law. Further, that the above named materials are properly classified, described, packaged, marked and labeled, and are in proper condition for transportation according to the applicable regulations of the Department of Transportation.

Susan Crowley
Generator/Authorized Agent Name

Susan Crowley
Signature

Date Shipped

TRANSPORTER INFORMATION

Transporter Name: Las Vegas Paving

DOT # 191949

Address: 4420 S. Decatur

Truck Number: 2700

Las Vegas, NV 89103

Phone Number: (702) 353-4355

I certify no hazardous waste or other regulated substance was knowingly introduced to the waste while in my custody. The waste transported in this vehicle is the waste identified above, to the best of my knowledge.

Mike DeFerra
Name of Authorized Agent

Mike DeFerra
Signature

9-30-10
Date Delivered

DISPOSAL SITE INFORMATION

Site Name: Apex Regional Landfill

Phone No. (702) 599-5920

Address: 13550 U.S. Hwy 93 Las Vegas, NV

I hereby acknowledge receipt of the above described materials

Jana Smith
Name (Print or Type)

Jana Smith
Signature

10-1-10
Date Received

81 Environmental Tech
13550 N Highway 93
Las Vegas, NV 89165

Ticket Type: INBOUND INVOICE

Ticket Number: 1533
Date: 10/01/2010
Time In: 1:23 am
Time Out: 1:44 am

Customer: 001011 - NGE, LLC c/o Northgate Environ Mgmt

Vehicle/Container: 81496P
Contract: Northgate Env. On Site Soils 3825 11
Comment: 3825 10 11244

Gross Weight: 121,320 LB Manual In
Tare Weight: 49,500 LB Manual Out
Net Weight: 71,820 LB
Net Tons: 35.91

BOL: 11640

Origin	Yards	Material	Billing	Quantity
Not Applicable	0.00 YD	SW CONTAMINATED SOIL	35.91	TN

Driver:

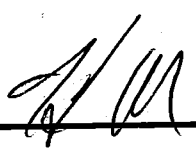

Weighmaster:

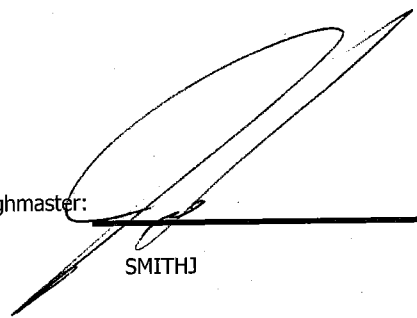

SMITHJ

Indemnification. Customer agrees, by signature above, to indemnify, hold harmless, and defend Republic Services, Inc., its subsidiaries, affiliates, employees, officers and directors from and against any and all liabilities, claims, penalties, forfeitures, suits and the costs and expenses incident thereto, including costs of defense, settlement, and reasonable attorney's fees, which may be incurred, as a result of death or injuries to any person, or damage to any property, contamination of or adverse effects on the environment, caused in whole or in part by the Customer, its employees, or subcontractors in disposing waste at this Facility. In the event Customer delivers Unacceptable Waste (as determined by Republic) Customer agrees to assume all expenses and obligations with the removal and/or resolution of any effects caused by the delivery of such Unacceptable Waste.

Indemnización. Cliente acuerda indemnizar, mantener inmune, y defender Republic Services, Inc., sus subsidiarios, compañías, divisiones, empleados, oficiales y directores contra de cualquiera y de todas responsabilidades, demandas, penas, pérdidas, juicios, pleitos y los costos incidente además, incluyendo costos de defensa, de acuerdo judicial, y de honorarios razonables del abogado, que pueden ser incurridos en, o como resultado de, la muerte o herida personal a cualquier persona, o daños a cualquier característica, propiedad, contaminación de la tierra o efectos ilícitos en esta Facilidad, causado entero o en parte por el cliente, sus empleados, o sus subcontratistas en botar basura en esta Facilidad. En el caso que el Cliente entrega, bota, basura (según lo determinado por Republic) en este Establecimiento basura inaceptable en los reglamentos de este Establecimiento, el Cliente se compromete asumir todos los costos y obligaciones con el retiro y/o la resolución de cualquier dano(s) causado por la entrega de tal basura inaceptable.



NON-HAZARDOUS WASTE MANIFEST

MANIFEST # 11640

GENERATOR INFORMATION

Generator Name: Tronox LLCAddress: P.O. Box 55City: Henderson County: ClarkState: NV Zip: 89009Site Location (if different): 560 W. Lake MeadHenderson, NV 89015 (702) 592-7727

CUSTOMER/BILLING INFORMATION

Billing Name: NGE LLC c/o Northgate Environment ManagementAddress: 300 Frank Ogawa Plaza, Ste 510City: Oakland County: AlamedaState: CA Zip: 94612

Republic Services Approval #	Description of Waste	Volume/Weight	Expiration Date	Container Type
38251011244	Soil for disposal		12-31-2011	Tractor with Dump Trailer(s)
	RZ- _____ # _____	35.91 70		

*Attach Additional Sheet if necessary

I hereby certify that the above-described materials are non-hazardous wastes as defined by 40 CFR 261 or any applicable state law. Further, that the above named materials are properly classified, described, packaged, marked and labeled, and are in proper condition for transportation according to the applicable regulations of the Department of Transportation.

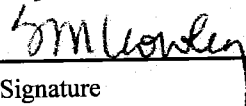
Susan Crowley  _____
 Generator/Authorized Agent Name Signature Date Shipped

TRANSPORTER INFORMATION

Transporter Name: Las Vegas PavingDOT # 191949Address: 4420 S. DecaturTruck Number: 145Las Vegas, NV 89103Phone Number: (702) 353-4355

I certify no hazardous waste or other regulated substance was knowingly introduced to the waste while in my custody. The waste transported in this vehicle is the waste identified above, to the best of my knowledge.

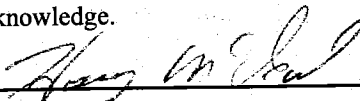
Harry Mc Biel  _____
 Name of Authorized Agent Signature Date Delivered 9-29-10

DISPOSAL SITE INFORMATION

Site Name: Apex Regional LandfillPhone No. (702) 599-5920Address: 13550 U.S. Hwy 93 Las Vegas, NV

I hereby acknowledge receipt of the above described materials

ESA Smith  _____
 Name (Print or Type) Signature Date Received 9-10

81 Environmental Tech
13550 N Highway 93
Las Vegas, NV 89165

Ticket Type: INBOUND INVOICE

Ticket Number: 1534
Date: 10/01/2010
Time In: 1:34 am
Time Out: 2:03 am

Customer: 001011 - NGE, LLC c/o Northgate Environ Mgmt

Vehicle/Container: 44564A
Contract: Northgate Env. On Site Soils 3825 11
Comment: 3825 10 11244

Gross Weight: 117,900 LB Manual In
Tare Weight: 49,100 LB Manual Out
Net Weight: 68800 LB
Net Tons: 34.40

BOL: 11641

Origin	Yards	Material	Billing	Quantity
Not Applicable	0.00 YD	SW CONTAMINATED SOIL	34.40	TN

Driver: _____

Weighmaster: _____

SMITHJ

Indemnification. Customer agrees, by signature above, to indemnify, hold harmless, and defend Republic Services, Inc., its subsidiaries, affiliates, employees, officers and directors from and against any and all liabilities, claims, penalties, forfeitures, suits and the costs and expenses incident thereto, including costs of defense, settlement, and reasonable attorney's fees, which may be incurred, as a result of death or injuries to any person, or damage to any property, contamination of or adverse effects on the environment, caused in whole or in part by the Customer, its employees, or subcontractors in disposing waste at this Facility. In the event Customer delivers Unacceptable Waste (as determined by Republic) Customer agrees to assume all expenses and obligations with the removal and/or resolution of any effects caused by the delivery of such Unacceptable Waste.

Indemnización. Cliente acuerda indemnizar, mantener inmune, y defender Republic Services, Inc., sus subsidiarios, compañías, divisiones, empleados, oficiales y directores contra de cualquiera y de todas responsabilidades, demandas, penas, pérdidas, juicios, pleitos y los costos incidente además, incluyendo costos de defensa, de acuerdo judicial, y de honorarios razonables del abogado, que pueden ser incurridos en, o como resultado de, la muerte o herida personal a cualquier persona, o daños a cualquier característica, propiedad, contaminación de la tierra o efectos ilícitos en esta Facilidad, causado entero o en parte por el cliente, sus empleados, o sus subcontratistas en botar basura en esta Facilidad. En el caso que el Cliente entrega, bota, basura (según lo determinado por Republic) en este Establecimiento basura inaceptable en los reglamentos de este Establecimiento, el Cliente se compromete asumir todos los costos y obligaciones con el retiro y/o la resolución de cualquier dano(s) causado por la entrega de tal basura inaceptable.



NON-HAZARDOUS WASTE MANIFEST

MANIFEST # 11641

GENERATOR INFORMATION

Generator Name: Tronox LLC
Address: P.O. Box 55
City: Henderson County: Clark
State: NV Zip: 89009
Site Location (if different): 560 W. Lake Mead
Henderson, NV 89015 (702) 592-7727

CUSTOMER/BILLING INFORMATION

Billing Name: NGE LLC c/o Northgate Environment Management
Address: 300 Frank Ogawa Plaza, Ste 510
City: Oakland County: Alameda
State: CA Zip: 94612

Table with 5 columns: Republic Services Approval #, Description of Waste, Volume/Weight, Expiration Date, Container Type. Row 1: 38251011244, Soil for disposal, 34.40 70, 12-31-2011, Tractor with Dump Trailer(s).

*Attach Additional Sheet if necessary

I hereby certify that the above-described materials are non-hazardous wastes as defined by 40 CFR 261 or any applicable state law. Further, that the above named materials are properly classified, described, packaged, marked and labeled, and are in proper condition for transportation according to the applicable regulations of the Department of Transportation.

Susan Crowley (Signature)
Generator/Authorized Agent Name Signature Date Shipped

TRANSPORTER INFORMATION

Transporter Name: Las Vegas Paving DOT # 191949
Address: 4420 S. Decatur Truck Number: K003
Las Vegas, NV 89103 Phone Number: (702) 353-4355

I certify no hazardous waste or other regulated substance was knowingly introduced to the waste while in my custody. The waste transported in this vehicle is the waste identified above, to the best of my knowledge.

Roseacion (Signature)
Name of Authorized Agent Signature Date Delivered 9/30/10

DISPOSAL SITE INFORMATION

Site Name: Apex Regional Landfill Phone No. (702) 599-5920
Address: 13550 U.S. Hwy 93 Las Vegas, NV

I hereby acknowledge receipt of the above described materials
Name (Print or Type) Signature Date Received 10-1-10

81 Environmental Tech
13550 N Highway 93
Las Vegas, NV 89165

Ticket Type: INBOUND INVOICE

Ticket Number: 1535
Date: 10/01/2010
Time In: 1:35 am
Time Out: 2:10 am

Customer: 001011 - NGE, LLC c/o Northgate Environ Mgmt

Vehicle/Container: 192456
Contract: Northgate Env. On Site Soils 3825 11
Comment: 3825 10 11244

Gross Weight: 126,140 LB Manual In
Tare Weight: 53,020 LB Manual Out
Net Weight: 73120 LB
Net Tons: 36.56

BOL: 11642

Origin	Yards	Material	Billing	Quantity
Not Applicable	0.00 YD	SW CONTAMINATED SOIL	36.56	TN

Driver: _____

Weighmaster: _____

SMITHJ

Indemnification. Customer agrees, by signature above, to indemnify, hold harmless, and defend Republic Services, Inc., its subsidiaries, affiliates, employees, officers and directors from and against any and all liabilities, claims, penalties, forfeitures, suits and the costs and expenses incident thereto, including costs of defense, settlement, and reasonable attorney's fees, which may be incurred, as a result of death or injuries to any person, or damage to any property, contamination of or adverse effects on the environment, caused in whole or in part by the Customer, its employees, or subcontractors in disposing waste at this Facility. In the event Customer delivers Unacceptable Waste (as determined by Republic) Customer agrees to assume all expenses and obligations with the removal and/or resolution of any effects caused by the delivery of such Unacceptable Waste.

Indemnización. Cliente acuerda indemnizar, mantener inmune, y defender Republic Services, Inc., sus subsidiarios, compañías, divisiones, empleados, oficiales y directores contra de cualquiera y de todas responsabilidades, demandas, penas, pérdidas, juicios, pleitos y los costos incidente además, incluyendo costos de defensa, de acuerdo judicial, y de honorarios razonables del abogado, que pueden ser incurridos en, o como resultado de, la muerte o herida personal a cualquier persona, o daños a cualquier característica, propiedad, contaminación de la tierra o efectos ilícitos en esta Facilidad, causado entero o en parte por el cliente, sus empleados, o sus subcontratistas en botar basura en esta Facilidad. En el caso que el Cliente entrega, bota, basura (según lo determinado por Republic) en este Establecimiento basura inaceptable en los reglamentos de este Establecimiento, el Cliente se compromete asumir todos los costos y obligaciones con el retiro y/o la resolución de cualquier dano(s) causado por la entrega de tal basura inaceptable.



NON-HAZARDOUS WASTE MANIFEST MANIFEST # 11542

GENERATOR INFORMATION

Generator Name: Tronox LLC
 Address: P.O. Box 55
 City: Henderson County: Clark
 State: NV Zip: 89009
 Site Location (if different): 560 W. Lake Mead
Henderson, NV 89015 (702) 592-7727

CUSTOMER/BILLING INFORMATION

Billing Name: NGE LLC c/o Northgate Environment Management
 Address: 300 Frank Ogawa Plaza, Ste 510
 City: Oakland County: Alameda
 State: CA Zip: 94612

Republic Services Approval #	Description of Waste	Volume/Weight	Expiration Date	Container Type
38251011244	Soil for disposal		12-31-2011	Tractor with Dump Trailer(s)
	RZ- _____ # _____	<u>26.56 Tlb</u>		

*Attach Additional Sheet if necessary

I hereby certify that the above-described materials are non-hazardous wastes as defined by 40 CFR 261 or any applicable state law. Further, that the above named materials are properly classified, described, packaged, marked and labeled, and are in proper condition for transportation according to the applicable regulations of the Department of Transportation.

Susan Crowley [Signature] _____
 Generator/Authorized Agent Name Signature Date Shipped

TRANSPORTER INFORMATION

Transporter Name: Las Vegas Paving DOT # 191949
 Address: 4420 S. Decatur Truck Number: 192456
Las Vegas, NV 89103 Phone Number: (702) 353-4355

I certify no hazardous waste or other regulated substance was knowingly introduced to the waste while in my custody. The waste transported in this vehicle is the waste identified above, to the best of my knowledge.

[Signature] [Signature] 9/29/10
 Name of Authorized Agent Signature Date Delivered

DISPOSAL SITE INFORMATION

Site Name: Apex Regional Landfill Phone No. (702) 599-5920
 Address: 13550 U.S. Hwy 93 Las Vegas, NV

I hereby acknowledge receipt of the above described materials
[Signature] [Signature] 10.1.10
 Name (Print or Type) Signature Date Received

81 Environmental Tech
13550 N Highway 93
Las Vegas, NV 89165

Ticket Type: INBOUND INVOICE

Ticket Number: 1536
Date: 10/01/2010
Time In: 1:41 am
Time Out: 2:10 am

Customer: 001011 - NGE, LLC c/o Northgate Environ Mgmt

Vehicle/Container: 192457
Contract: Northgate Env. On Site Soils 3825 11
Comment: 3825 10 11244

Gross Weight: 121,620 LB Manual In
Tare Weight: 51,860 LB Manual Out
Net Weight: 69760 LB
Net Tons: 34.88

BOL: 11643

Origin	Yards	Material	Billing	Quantity
Not Applicable	0.00 YD	SW CONTAMINATED SOIL	34.88	TN

Driver: 

Weighmaster: 

SMITHJ

Indemnification. Customer agrees, by signature above, to indemnify, hold harmless, and defend Republic Services, Inc., its subsidiaries, affiliates, employees, officers and directors from and against any and all liabilities, claims, penalties, forfeitures, suits and the costs and expenses incident thereto, including costs of defense, settlement, and reasonable attorney's fees, which may be incurred, as a result of death or injuries to any person, or damage to any property, contamination of or adverse effects on the environment, caused in whole or in part by the Customer, its employees, or subcontractors in disposing waste at this Facility. In the event Customer delivers Unacceptable Waste (as determined by Republic) Customer agrees to assume all expenses and obligations with the removal and/or resolution of any effects caused by the delivery of such Unacceptable Waste.

Indemnización. Cliente acuerda indemnizar, mantener inmune, y defender Republic Services, Inc., sus subsidiarios, compañías, divisiones, empleados, oficiales y directores contra de cualquiera y de todas responsabilidades, demandas, penas, pérdidas, juicios, pleitos y los costos incidente además, incluyendo costos de defensa, de acuerdo judicial, y de honorarios razonables del abogado, que pueden ser incurridos en, o como resultado de, la muerte o herida personal a cualquier persona, o daños a cualquier característica, propiedad, contaminación de la tierra o efectos ilícitos en esta Facilidad, causado entero o en parte por el cliente, sus empleados, o sus subcontratistas en botar basura en esta Facilidad. En el caso que el Cliente entrega, bota, basura (según lo determinado por Republic) en este Establecimiento basura inaceptable en los reglamentos de este Establecimiento, el Cliente se compromete asumir todos los costos y obligaciones con el retiro y/o la resolución de cualquier dano(s) causado por la entrega de tal basura inaceptable.



NON-HAZARDOUS WASTE MANIFEST

MANIFEST # 11643

GENERATOR INFORMATION

Generator Name: Tronox LLC

Address: P.O. Box 55

City: Henderson County: Clark

State: NV Zip: 89009

Site Location (if different): 560 W. Lake Mead
Henderson, NV 89015 (702) 592-7727

CUSTOMER/BILLING INFORMATION

Billing Name: NGE LLC c/o Northgate Environment Management

Address: 300 Frank Ogawa Plaza, Ste 510

City: Oakland County: Alameda

State: CA Zip: 94612

Republic Services Approval #	Description of Waste	Volume/Weight	Expiration Date	Container Type
38251011244	Soil for disposal		12-31-2011	Tractor with Dump Trailer(s)
	RZ-_____#_____	34.88 10		

*Attach Additional Sheet if necessary

I hereby certify that the above-described materials are non-hazardous wastes as defined by 40 CFR 261 or any applicable state law. Further, that the above named materials are properly classified, described, packaged, marked and labeled, and are in proper condition for transportation according to the applicable regulations of the Department of Transportation.

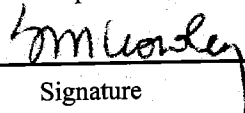
Susan Crowley  _____
 Generator/Authorized Agent Name Signature Date Shipped

TRANSPORTER INFORMATION

Transporter Name: Las Vegas Paving

DOT # 191949

Address: 4420 S. Decatur

Truck Number: 192457

Las Vegas, NV 89103

Phone Number: (702) 353-4355

I certify no hazardous waste or other regulated substance was knowingly introduced to the waste while in my custody. The waste transported in this vehicle is the waste identified above, to the best of my knowledge.

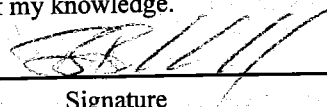
Brian Brinkhoff  _____ 9-30-10
 Name of Authorized Agent Signature Date Delivered

DISPOSAL SITE INFORMATION

Site Name: Apex Regional Landfill

Phone No. (702) 599-5920

Address: 13550 U.S. Hwy 93 Las Vegas, NV

I hereby acknowledge receipt of the above described materials

[Signature] _____ 9-30-10
 Name (Print or Type) Signature Date Received

81 Environmental Tech
13550 N Highway 93
Las Vegas, NV 89165

Ticket Type: INBOUND INVOICE

Ticket Number: 1537
Date: 10/01/2010
Time In: 1:45 am
Time Out: 2:14 am

Customer: 001011 - NGE, LLC c/o Northgate Environ Mgmt

Vehicle/Container: 192460
Contract: Northgate Env. On Site Soils 3825 11
Comment: 3825 10 11244

Gross Weight: 127,120 LB Manual In
Tare Weight: 53,040 LB Manual Out
Net Weight: 74080 LB
Net Tons: 37.04

BOL: 11644

Origin	Yards	Material	Billing	Quantity
Not Applicable	0.00 YD	SW CONTAMINATED SOIL	37.04	TN

Driver:

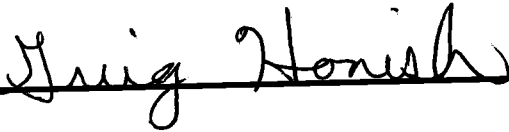

Weighmaster:



SMITHJ

Indemnification. Customer agrees, by signature above, to indemnify, hold harmless, and defend Republic Services, Inc., its subsidiaries, affiliates, employees, officers and directors from and against any and all liabilities, claims, penalties, forfeitures, suits and the costs and expenses incident thereto, including costs of defense, settlement, and reasonable attorney's fees, which may be incurred, as a result of death or injuries to any person, or damage to any property, contamination of or adverse effects on the environment, caused in whole or in part by the Customer, its employees, or subcontractors in disposing waste at this Facility. In the event Customer delivers Unacceptable Waste (as determined by Republic) Customer agrees to assume all expenses and obligations with the removal and/or resolution of any effects caused by the delivery of such Unacceptable Waste.

Indemnización. Cliente acuerda indemnizar, mantener inmune, y defender Republic Services, Inc., sus subsidiarios, compañías, divisiones, empleados, oficiales y directores contra de cualquiera y de todas responsabilidades, demandas, penas, pérdidas, juicios, pleitos y los costos incidente además, incluyendo costos de defensa, de acuerdo judicial, y de honorarios razonables del abogado, que pueden ser incurridos en, o como resultado de, la muerte o herida personal a cualquier persona, o daños a cualquier característica, propiedad, contaminación de la tierra o efectos ilícitos en esta Facilidad, causado entero o en parte por el cliente, sus empleados, o sus subcontratistas en botar basura en esta Facilidad. En el caso que el Cliente entrega, bota, basura (según lo determinado por Republic) en este Establecimiento basura inaceptable en los reglamentos de este Establecimiento, el Cliente se compromete asumir todos los costos y obligaciones con el retiro y/o la resolución de cualquier dano(s) causado por la entrega de tal basura inaceptable.



NON-HAZARDOUS WASTE MANIFEST

MANIFEST # 11644

GENERATOR INFORMATION

Generator Name: Tronox LLC
Address: P.O. Box 55
City: Henderson County: Clark
State: NV Zip: 89009
Site Location (if different): 560 W. Lake Mead
Henderson, NV 89015 (702) 592-7727

CUSTOMER/BILLING INFORMATION

Billing Name: NGE LLC c/o Northgate Environment Management
Address: 300 Frank Ogawa Plaza, Ste 510
City: Oakland County: Alameda
State: CA Zip: 94612

Table with 5 columns: Republic Services Approval #, Description of Waste, Volume/Weight, Expiration Date, Container Type. Row 1: 38251011244, Soil for disposal, 37.04 TW, 12-31-2011, Tractor with Dump Trailer(s).

*Attach Additional Sheet if necessary

I hereby certify that the above-described materials are non-hazardous wastes as defined by 40 CFR 261 or any applicable state law. Further, that the above named materials are properly classified, described, packaged, marked and labeled, and are in proper condition for transportation according to the applicable regulations of the Department of Transportation.

Susan Crowley (Signature)
Generator/Authorized Agent Name Signature Date Shipped

TRANSPORTER INFORMATION

Transporter Name: Las Vegas Paving DOT # 191949
Address: 4420 S. Decatur Truck Number: 2765
Las Vegas, NV 89103 Phone Number: (702) 353-4355

I certify no hazardous waste or other regulated substance was knowingly introduced to the waste while in my custody. The waste transported in this vehicle is the waste identified above, to the best of my knowledge.

Gregg Honish (Signature)
Name of Authorized Agent Signature Date Delivered 9-30-10

DISPOSAL SITE INFORMATION

Site Name: Apex Regional Landfill Phone No. (702) 599-5920
Address: 13550 U.S. Hwy 93 Las Vegas, NV

I hereby acknowledge receipt of the above described materials

John Smith (Signature)
Name (Print or Type) Signature Date Received 10-1-10

81 Environmental Tech
13550 N Highway 93
Las Vegas, NV 89165

Ticket Type: INBOUND INVOICE

Ticket Number: 1538
Date: 10/01/2010
Time In: 1:58 am
Time Out: 2:25 am

Customer: 001011 - NGE, LLC c/o Northgate Environ Mgmt

Vehicle/Container: 44161A
Contract: Northgate Env. On Site Soils 3825 11
Comment: 3825 10 11244

Gross Weight: 122,420 LB Manual In
Tare Weight: 52,780 LB Manual Out
Net Weight: 69640 LB
Net Tons: 34.82

BOL: 11645

Origin	Yards	Material	Billing	Quantity
Not Applicable	0.00 YD	SW CONTAMINATED SOIL	34.82	TN

Driver:

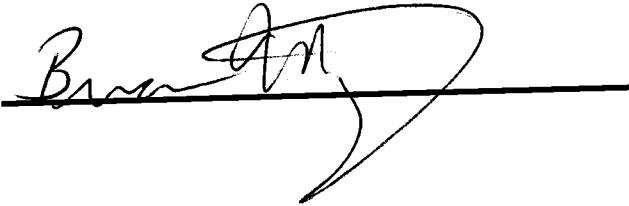

Weighmaster:

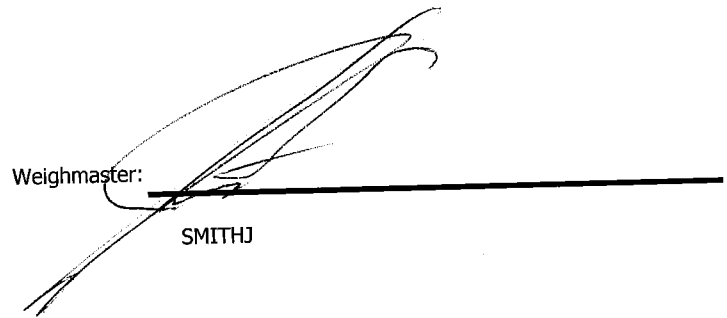

SMITHJ

Indemnification. Customer agrees, by signature above, to indemnify, hold harmless, and defend Republic Services, Inc., its subsidiaries, affiliates, employees, officers and directors from and against any and all liabilities, claims, penalties, forfeitures, suits and the costs and expenses incident thereto, including costs of defense, settlement, and reasonable attorney's fees, which may be incurred, as a result of death or injuries to any person, or damage to any property, contamination of or adverse effects on the environment, caused in whole or in part by the Customer, its employees, or subcontractors in disposing waste at this Facility. In the event Customer delivers Unacceptable Waste (as determined by Republic) Customer agrees to assume all expenses and obligations with the removal and/or resolution of any effects caused by the delivery of such Unacceptable Waste.

Indemnización. Cliente acuerda indemnizar, mantener inmune, y defender Republic Services, Inc., sus subsidiarios, compañías, divisiones, empleados, oficiales y directores contra de cualquiera y de todas responsabilidades, demandas, penas, pérdidas, juicios, pleitos y los costos incidente además, incluyendo costos de defensa, de acuerdo judicial, y de honorarios razonables del abogado, que pueden ser incurridos en, o como resultado de, la muerte o herida personal a cualquier persona, o daños a cualquier característica, propiedad, contaminación de la tierra o efectos ilícitos en esta Facilidad, causado entero o en parte por el cliente, sus empleados, o sus subcontratistas en botar basura en esta Facilidad. En el caso que el Cliente entrega, bota, basura (según lo determinado por Republic) en este Establecimiento basura inaceptable en los reglamentos de este Establecimiento, el Cliente se compromete asumir todos los costos y obligaciones con el retiro y/o la resolución de cualquier dano(s) causado por la entrega de tal basura inaceptable.



NON-HAZARDOUS WASTE MANIFEST

MANIFEST # 11645

GENERATOR INFORMATION

Generator Name: Tronox LLC

Address: P.O. Box 55

City: Henderson County: Clark

State: NV Zip: 89009

Site Location (if different): 560 W. Lake Mead
Henderson, NV 89015 (702) 592-7727

CUSTOMER/BILLING INFORMATION

Billing Name: NGE LLC c/o Northgate Environment Management

Address: 300 Frank Ogawa Plaza, Ste 510

City: Oakland County: Alameda

State: CA Zip: 94612

Table with 5 columns: Republic Services Approval #, Description of Waste, Volume/Weight, Expiration Date, Container Type. Row 1: 38251011244, Soil for disposal, 12-31-2011, Tractor with Dump Trailer(s).

*Attach Additional Sheet if necessary

I hereby certify that the above-described materials are non-hazardous wastes as defined by 40 CFR 261 or any applicable state law. Further, that the above named materials are properly classified, described, packaged, marked and labeled, and are in proper condition for transportation according to the applicable regulations of the Department of Transportation.

Susan Crowley (Signature)
Generator/Authorized Agent Name Signature Date Shipped

TRANSPORTER INFORMATION

Transporter Name: Las Vegas Paving

DOT # 191949

Address: 4420 S. Decatur

Truck Number: K-005

Las Vegas, NV 89103

Phone Number: (702) 353-4355

I certify no hazardous waste or other regulated substance was knowingly introduced to the waste while in my custody. The waste transported in this vehicle is the waste identified above, to the best of my knowledge.

Blair M... (Signature)
Name of Authorized Agent Signature Date Delivered 9-30-10

DISPOSAL SITE INFORMATION

Site Name: Apex Regional Landfill

Phone No. (702) 599-5920

Address: 13550 U.S. Hwy 93 Las Vegas, NV

I hereby acknowledge receipt of the above described materials

(Signature)
Name (Print or Type) Signature Date Received 10-1-10

81 Environmental Tech
13550 N Highway 93
Las Vegas, NV 89165

Ticket Type: INBOUND INVOICE

Ticket Number: 1539
Date: 10/01/2010
Time In: 2:10 am
Time Out: 2:39 am

Customer: 001011 - NGE, LLC c/o Northgate Environ Mgmt

Vehicle/Container: 85430P
Contract: Northgate Env. On Site Soils 3825 14
Comment: 3825 10 11244

Gross Weight: 125,340 LB Manual In
Tare Weight: 54,340 LB Manual Out
Net Weight: 71000 LB
Net Tons: 35.50

BOL: 11646

Origin	Yards	Material	Billing	Quantity
Not Applicable	0.00 YD	SW CONTAMINATED SOIL	35.50	TN

Driver:

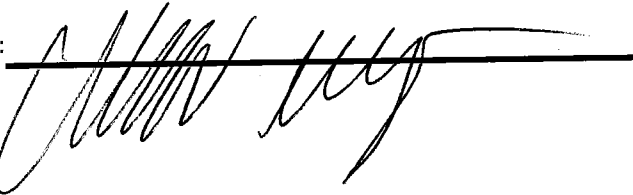

Weighmaster:

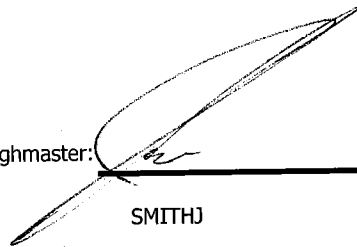

SMITHJ

Indemnification. Customer agrees, by signature above, to indemnify, hold harmless, and defend Republic Services, Inc., its subsidiaries, affiliates, employees, officers and directors from and against any and all liabilities, claims, penalties, forfeitures, suits and the costs and expenses incident thereto, including costs of defense, settlement, and reasonable attorney's fees, which may be incurred, as a result of death or injuries to any person, or damage to any property, contamination of or adverse effects on the environment, caused in whole or in part by the Customer, its employees, or subcontractors in disposing waste at this Facility. In the event Customer delivers Unacceptable Waste (as determined by Republic) Customer agrees to assume all expenses and obligations with the removal and/or resolution of any effects caused by the delivery of such Unacceptable Waste.

Indemnización. Cliente acuerda indemnizar, mantener inmune, y defender Republic Services, Inc., sus subsidiarios, compañías, divisiones, empleados, oficiales y directores contra de cualquiera y de todas responsabilidades, demandas, penas, pérdidas, juicios, pleitos y los costos incidente además, incluyendo costos de defensa, de acuerdo judicial, y de honorarios razonables del abogado, que pueden ser incurridos en, o como resultado de, la muerte o herida personal a cualquier persona, o daños a cualquier característica, propiedad, contaminación de la tierra o efectos ilícitos en esta Facilidad, causado entero o en parte por el cliente, sus empleados, o sus subcontratistas en botar basura en esta Facilidad. En el caso que el Cliente entrega, bota, basura (según lo determinado por Republic) en este Establecimiento basura inaceptable en los reglamentos de este Establecimiento, el Cliente se compromete asumir todos los costos y obligaciones con el retiro y/o la resolución de cualquier dano(s) causado por la entrega de tal basura inaceptable.



NON-HAZARDOUS WASTE MANIFEST

MANIFEST # 11646

GENERATOR INFORMATION

Generator Name: Tronox LLC
Address: P.O. Box 55
City: Henderson County: Clark
State: NV Zip: 89009
Site Location (if different): 560 W. Lake Mead
Henderson, NV 89015 (702) 592-7727

CUSTOMER/BILLING INFORMATION

Billing Name: NGE LLC c/o Northgate Environment Management
Address: 300 Frank Ogawa Plaza, Ste 510
City: Oakland County: Alameda
State: CA Zip: 94612

Table with 5 columns: Republic Services Approval #, Description of Waste, Volume/Weight, Expiration Date, Container Type. Row 1: 38251011244, Soil for disposal, 35.50 TN, 12-31-2011, Tractor with Dump Trailer(s).

*Attach Additional Sheet if necessary

I hereby certify that the above-described materials are non-hazardous wastes as defined by 40 CFR 261 or any applicable state law. Further, that the above named materials are properly classified, described, packaged, marked and labeled, and are in proper condition for transportation according to the applicable regulations of the Department of Transportation.

Susan Crowley
Generator/Authorized Agent Name Signature Date Shipped

TRANSPORTER INFORMATION

Transporter Name: Las Vegas Paving DOT # 191949
Address: 4420 S. Decatur Truck Number: 87
Las Vegas, NV 89103 Phone Number: (702) 353-4355

I certify no hazardous waste or other regulated substance was knowingly introduced to the waste while in my custody. The waste transported in this vehicle is the waste identified above, to the best of my knowledge.

NERI 5054
Name of Authorized Agent Signature Date Delivered 9/30/10

DISPOSAL SITE INFORMATION

Site Name: Apex Regional Landfill Phone No. (702) 599-5920
Address: 13550 U.S. Hwy 93 Las Vegas, NV

I hereby acknowledge receipt of the above described materials
Name (Print or Type) Signature Date Received

81 Environmental Tech
13550 N Highway 93
Las Vegas, NV 89165

Ticket Type: INBOUND INVOICE

Ticket Number: 1540
Date: 10/01/2010
Time In: 2:46 am
Time Out: 3:08 am

Customer: 001011 - NGE, LLC c/o Northgate Environ Mgmt

Vehicle/Container: 44165A
Contract: Northgate Env. On Site Soils 3825 11
Comment: 3825 10 11244

Gross Weight: 123,360 LB Manual In
Tare Weight: 49,040 LB Manual Out
Net Weight: 74320 LB
Net Tons: 37.16

BOL: 11647

Origin	Yards	Material	Billing	Quantity
Not Applicable	0.00 YD	SW CONTAMINATED SOIL	37.16	TN

Driver:



Weighmaster:



SMITHJ

Indemnification. Customer agrees, by signature above, to indemnify, hold harmless, and defend Republic Services, Inc., its subsidiaries, affiliates, employees, officers and directors from and against any and all liabilities, claims, penalties, forfeitures, suits and the costs and expenses incident thereto, including costs of defense, settlement, and reasonable attorney's fees, which may be incurred, as a result of death or injuries to any person, or damage to any property, contamination of or adverse effects on the environment, caused in whole or in part by the Customer, its employees, or subcontractors in disposing waste at this Facility. In the event Customer delivers Unacceptable Waste (as determined by Republic) Customer agrees to assume all expenses and obligations with the removal and/or resolution of any effects caused by the delivery of such Unacceptable Waste.

Indemnización. Cliente acuerda indemnizar, mantener inmune, y defender Republic Services, Inc., sus subsidiarios, compañías, divisiones, empleados, oficiales y directores contra de cualquiera y de todas responsabilidades, demandas, penas, pérdidas, juicios, pleitos y los costos incidente además, incluyendo costos de defensa, de acuerdo judicial, y de honorarios razonables del abogado, que pueden ser incurridos en, o como resultado de, la muerte o herida personal a cualquier persona, o daños a cualquier característica, propiedad, contaminación de la tierra o efectos ilícitos en esta Facilidad, causado entero o en parte por el cliente, sus empleados, o sus subcontratistas en botar basura en esta Facilidad. En el caso que el Cliente entrega, bota, basura (según lo determinado por Republic) en este Establecimiento basura inaceptable en los reglamentos de este Establecimiento, el Cliente se compromete asumir todos los costos y obligaciones con el retiro y/o la resolución de cualquier dano(s) causado por la entrega de tal basura inaceptable.



NON-HAZARDOUS WASTE MANIFEST

MANIFEST # 11647

GENERATOR INFORMATION

Generator Name: Tronox LLC

Address: P.O. Box 55

City: Henderson County: Clark

State: NV Zip: 89009

Site Location (if different): 560 W. Lake Mead

Henderson, NV 89015 (702) 592-7727

CUSTOMER/BILLING INFORMATION

Billing Name: NGE LLC c/o Northgate Environment Management

Address: 300 Frank Ogawa Plaza, Ste 510

City: Oakland County: Alameda

State: CA Zip: 94612

Republic Services Approval #	Description of Waste	Volume/Weight	Expiration Date	Container Type
38251011244	Soil for disposal		12-31-2011	Tractor with Dump Trailer(s)
	RZ- _____ # _____	37.16 TN		

*Attach Additional Sheet if necessary

I hereby certify that the above-described materials are non-hazardous wastes as defined by 40 CFR 261 or any applicable state law. Further, that the above named materials are properly classified, described, packaged, marked and labeled, and are in proper condition for transportation according to the applicable regulations of the Department of Transportation.

Susan Crowley
Generator/Authorized Agent Name

Susan Crowley
Signature

Date Shipped

TRANSPORTER INFORMATION

Transporter Name: Las Vegas Paving

DOT # 191949

Address: 4420 S. Decatur

Truck Number: K001

Las Vegas, NV 89103

Phone Number: (702) 353-4355

I certify no hazardous waste or other regulated substance was knowingly introduced to the waste while in my custody. The waste transported in this vehicle is the waste identified above, to the best of my knowledge.

Kamon
Name of Authorized Agent

Kamon
Signature

9-30-10
Date Delivered

DISPOSAL SITE INFORMATION

Site Name: Apex Regional Landfill

Phone No. (702) 599-5920

Address: 13550 U.S. Hwy 93 Las Vegas, NV

I hereby acknowledge receipt of the above described materials

Doreen Smith
Name (Print or Type)

Doreen Smith
Signature

10/1/10
Date Received

81 Environmental Tech
13550 N Highway 93
Las Vegas, NV 89165

Ticket Type: INBOUND INVOICE

Ticket Number: 1541
Date: 10/01/2010
Time In: 2:47 am
Time Out: 3:11 am

Customer: 001011 - NGE, LLC c/o Northgate Environ Mgmt

Vehicle/Container: A004505
Contract: Northgate Env. On Site Soils 3825 11
Comment: 3825 10 11244

Gross Weight: 78,600 LB Manual In
Tare Weight: 37,560 LB Manual Out
Net Weight: 41040 LB
Net Tons: 20.52

BOL: 11650

Origin	Yards	Material	Billing	Quantity
Not Applicable	0.00 YD	SW CONTAMINATED SOIL	20.52	TN

Driver: 

Weighmaster: 

SMITHJ

Indemnification. Customer agrees, by signature above, to indemnify, hold harmless, and defend Republic Services, Inc., its subsidiaries, affiliates, employees, officers and directors from and against any and all liabilities, claims, penalties, forfeitures, suits and the costs and expenses incident thereto, including costs of defense, settlement, and reasonable attorney's fees, which may be incurred, as a result of death or injuries to any person, or damage to any property, contamination of or adverse effects on the environment, caused in whole or in part by the Customer, its employees, or subcontractors in disposing waste at this Facility. In the event Customer delivers Unacceptable Waste (as determined by Republic) Customer agrees to assume all expenses and obligations with the removal and/or resolution of any effects caused by the delivery of such Unacceptable Waste.

Indemnización. Cliente acuerda indemnizar, mantener inmune, y defender Republic Services, Inc., sus subsidiarios, compañías, divisiones, empleados, oficiales y directores contra de cualquiera y de todas responsabilidades, demandas, penas, pérdidas, juicios, pleitos y los costos incidente además, incluyendo costos de defensa, de acuerdo judicial, y de honorarios razonables del abogado, que pueden ser incurridos en, o como resultado de, la muerte o herida personal a cualquier persona, o daños a cualquier característica, propiedad, contaminación de la tierra o efectos ilícitos en esta Facilidad, causado entero o en parte por el cliente, sus empleados, o sus subcontratistas en botar basura en esta Facilidad. En el caso que el Cliente entrega, bota, basura (según lo determinado por Republic) en este Establecimiento basura inaceptable en los reglamentos de este Establecimiento, el Cliente se compromete asumir todos los costos y obligaciones con el retiro y/o la resolución de cualquier dano(s) causado por la entrega de tal basura inaceptable.



NON-HAZARDOUS WASTE MANIFEST

MANIFEST # 11650

GENERATOR INFORMATION

Generator Name: Tronox LLC

Address: P.O. Box 55

City: Henderson County: Clark

State: NV Zip: 89009

Site Location (if different): 560 W. Lake Mead

Henderson, NV 89015 (702) 592-7727

CUSTOMER/BILLING INFORMATION

Billing Name: NGE LLC c/o Northgate Environment Management

Address: 300 Frank Ogawa Plaza, Ste 510

City: Oakland County: Alameda

State: CA Zip: 94612

Republic Services Approval #	Description of Waste	Volume/Weight	Expiration Date	Container Type
38251011244	Soil for disposal		12-31-2011	Tractor with Dump Trailer(s)
	RZ- _____ # _____	10.52 TB		

*Attach Additional Sheet if necessary

I hereby certify that the above-described materials are non-hazardous wastes as defined by 40 CFR 261 or any applicable state law. Further, that the above named materials are properly classified, described, packaged, marked and labeled, and are in proper condition for transportation according to the applicable regulations of the Department of Transportation.

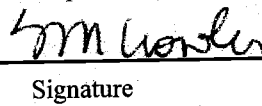
Susan Crowley  _____
 Generator/Authorized Agent Name Signature Date Shipped

TRANSPORTER INFORMATION

Transporter Name: Las Vegas Paving

DOT # 191949

Address: 4420 S. Decatur

Truck Number: 44

Las Vegas, NV 89103

Phone Number: (702) 353-4355

I certify no hazardous waste or other regulated substance was knowingly introduced to the waste while in my custody. The waste transported in this vehicle is the waste identified above, to the best of my knowledge.

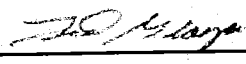
Tom Casper  9-30-10
 Name of Authorized Agent Signature Date Delivered

DISPOSAL SITE INFORMATION

Site Name: Apex Regional Landfill

Phone No. (702) 599-5920

Address: 13550 U.S. Hwy 93 Las Vegas, NV

I hereby acknowledge receipt of the above described materials

Joe Smith  10/1/10
 Name (Print or Type) Signature Date Received

81 Environmental Tech
13550 N Highway 93
Las Vegas, NV 89165

Ticket Type: INBOUND INVOICE

Ticket Number: 1542
Date: 10/01/2010
Time In: 2:56 am
Time Out: 3:19 am

Customer: 001011 - NGE, LLC c/o Northgate Environ Mgmt

Vehicle/Container: 76810P
Contract: Northgate Env. On Site Soils 3825 11
Comment: 3825 10 11244

Gross Weight: 128,100 LB Manual In
Tare Weight: 54,660 LB Manual Out
Net Weight: 73,440 LB
Net Tons: 36.72

BOL: 11648

Origin	Yards	Material	Billing	Quantity
Not Applicable	0.00 YD	SW CONTAMINATED SOIL	36.72	TN

Driver:

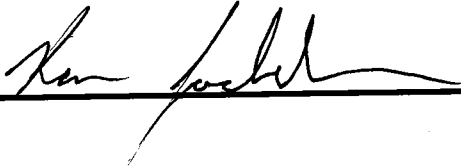

Weighmaster:

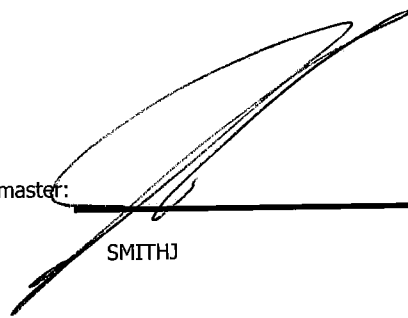

SMITHJ

Indemnification. Customer agrees, by signature above, to indemnify, hold harmless, and defend Republic Services, Inc., its subsidiaries, affiliates, employees, officers and directors from and against any and all liabilities, claims, penalties, forfeitures, suits and the costs and expenses incident thereto, including costs of defense, settlement, and reasonable attorney's fees, which may be incurred, as a result of death or injuries to any person, or damage to any property, contamination of or adverse effects on the environment, caused in whole or in part by the Customer, its employees, or subcontractors in disposing waste at this Facility. In the event Customer delivers Unacceptable Waste (as determined by Republic) Customer agrees to assume all expenses and obligations with the removal and/or resolution of any effects caused by the delivery of such Unacceptable Waste.

Indemnización. Cliente acuerda indemnizar, mantener inmune, y defender Republic Services, Inc., sus subsidiarios, compañías, divisiones, empleados, oficiales y directores contra de cualquiera y de todas responsabilidades, demandas, penas, pérdidas, juicios, pleitos y los costos incidente además, incluyendo costos de defensa, de acuerdo judicial, y de honorarios razonables del abogado, que pueden ser incurridos en, o como resultado de, la muerte o herida personal a cualquier persona, o daños a cualquier característica, propiedad, contaminación de la tierra o efectos ilícitos en esta Facilidad, causado entero o en parte por el cliente, sus empleados, o sus subcontratistas en botar basura en esta Facilidad. En el caso que el Cliente entrega, bota, basura (según lo determinado por Republic) en este Establecimiento basura inaceptable en los reglamentos de este Establecimiento, el Cliente se compromete asumir todos los costos y obligaciones con el retiro y/o la resolución de cualquier dano(s) causado por la entrega de tal basura inaceptable.



NON-HAZARDOUS WASTE MANIFEST

MANIFEST # 11848

GENERATOR INFORMATION

Generator Name: Tronox LLC

Address: P.O. Box 55

City: Henderson County: Clark

State: NV Zip: 89009

Site Location (if different): 560 W. Lake Mead

Henderson, NV 89015 (702) 592-7727

CUSTOMER/BILLING INFORMATION

Billing Name: NGE LLC c/o Northgate Environment Management

Address: 300 Frank Ogawa Plaza, Ste 510

City: Oakland County: Alameda

State: CA Zip: 94612

Table with 5 columns: Republic Services Approval #, Description of Waste, Volume/Weight, Expiration Date, Container Type. Row 1: 38251011244, Soil for disposal, RZ- #, 2-7270, 12-31-2011, Tractor with Dump Trailer(s).

*Attach Additional Sheet if necessary

I hereby certify that the above-described materials are non-hazardous wastes as defined by 40 CFR 261 or any applicable state law. Further, that the above named materials are properly classified, described, packaged, marked and labeled, and are in proper condition for transportation according to the applicable regulations of the Department of Transportation.

Susan Crowley
Generator/Authorized Agent Name

Signature (Susan Crowley)

Date Shipped

TRANSPORTER INFORMATION

Transporter Name: Las Vegas Paving

DOT # 191949

Address: 4420 S. Decatur

Truck Number: 241

Las Vegas, NV 89103

Phone Number: (702) 353-4355

I certify no hazardous waste or other regulated substance was knowingly introduced to the waste while in my custody. The waste transported in this vehicle is the waste identified above, to the best of my knowledge.

Name of Authorized Agent (Ken Sacristan)

Signature (Ken Sacristan)

Date Delivered: 9-30-2010

DISPOSAL SITE INFORMATION

Site Name: Apex Regional Landfill

Phone No. (702) 599-5920

Address: 13550 U.S. Hwy 93 Las Vegas, NV

I hereby acknowledge receipt of the above described materials

Name (Print or Type)

Signature

Date Received

81 Environmental Tech
13550 N Highway 93
Las Vegas, NV 89165

Ticket Type: INBOUND INVOICE

Ticket Number: 1543
Date: 10/01/2010
Time In: 2:58 am
Time Out: 3:21 am

Customer: 001011 - NGE, LLC c/o Northgate Environ Mgmt

Vehicle/Container: 82418P
Contract: Northgate Env. On Site Soils 3825 11
Comment: 3825 10 11244

Gross Weight: 137,320 LB Manual In
Tare Weight: 63,280 LB Manual Out
Net Weight: 74040 LB
Net Tons: 37.02

BOL: 11649

Origin	Yards	Material	Billing	Quantity
Not Applicable	0.00 YD	SW CONTAMINATED SOIL	37.02	TN

Driver: _____

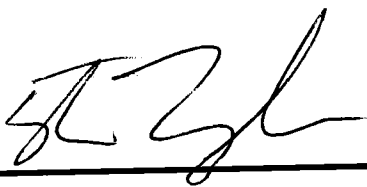

Weighmaster: _____

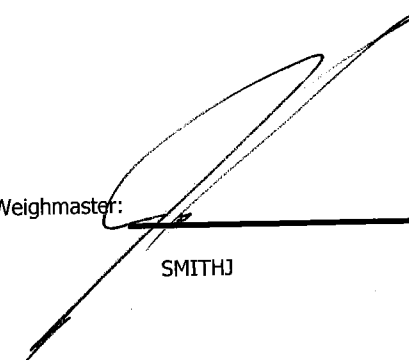

SMITHJ

Indemnification. Customer agrees, by signature above, to indemnify, hold harmless, and defend Republic Services, Inc., its subsidiaries, affiliates, employees, officers and directors from and against any and all liabilities, claims, penalties, forfeitures, suits and the costs and expenses incident thereto, including costs of defense, settlement, and reasonable attorney's fees, which may be incurred, as a result of death or injuries to any person, or damage to any property, contamination of or adverse effects on the environment, caused in whole or in part by the Customer, its employees, or subcontractors in disposing waste at this Facility. In the event Customer delivers Unacceptable Waste (as determined by Republic) Customer agrees to assume all expenses and obligations with the removal and/or resolution of any effects caused by the delivery of such Unacceptable Waste.

Indemnización. Cliente acuerda indemnizar, mantener inmune, y defender Republic Services, Inc., sus subsidiarios, compañías, divisiones, empleados, oficiales y directores contra de cualquiera y de todas responsabilidades, demandas, penas, pérdidas, juicios, pleitos y los costos incidente además, incluyendo costos de defensa, de acuerdo judicial, y de honorarios razonables del abogado, que pueden ser incurridos en, o como resultado de, la muerte o herida personal a cualquier persona, o daños a cualquier característica, propiedad, contaminación de la tierra o efectos ilícitos en esta Facilidad, causado entero o en parte por el cliente, sus empleados, o sus subcontratistas en botar basura en esta Facilidad. En el caso que el Cliente entrega, bota, basura (según lo determinado por Republic) en este Establecimiento basura inaceptable en los reglamentos de este Establecimiento, el Cliente se compromete asumir todos los costos y obligaciones con el retiro y/o la resolución de cualquier dano(s) causado por la entrega de tal basura inaceptable.



NON-HAZARDOUS WASTE MANIFEST

MANIFEST # 11649

GENERATOR INFORMATION

Generator Name: Tronox LLC

Address: P.O. Box 55

City: Henderson County: Clark

State: NV Zip: 89009

Site Location (if different): 560 W. Lake Mead

Henderson, NV 89015 (702) 592-7727

CUSTOMER/BILLING INFORMATION

Billing Name: NGE LLC c/o Northgate Environment Management

Address: 300 Frank Ogawa Plaza, Ste 510

City: Oakland County: Alameda

State: CA Zip: 94612

Republic Services Approval #	Description of Waste	Volume/Weight	Expiration Date	Container Type
38251011244	Soil for disposal		12-31-2011	Tractor with Dump Trailer(s)
	RZ-_____#_____	37.02 Tlb		

*Attach Additional Sheet if necessary

I hereby certify that the above-described materials are non-hazardous wastes as defined by 40 CFR 261 or any applicable state law. Further, that the above named materials are properly classified, described, packaged, marked and labeled, and are in proper condition for transportation according to the applicable regulations of the Department of Transportation.

Susan Crowley (Signature) Generator/Authorized Agent Name Date Shipped

TRANSPORTER INFORMATION

Transporter Name: Las Vegas Paving

DOT # 191949

Address: 4420 S. Decatur

Truck Number: 2110

Las Vegas, NV 89103

Phone Number: (702) 353-4355

I certify no hazardous waste or other regulated substance was knowingly introduced to the waste while in my custody. The waste transported in this vehicle is the waste identified above, to the best of my knowledge.

STEVE TAYLOR (Signature) Name of Authorized Agent Date Delivered 9-30-10

DISPOSAL SITE INFORMATION

Site Name: Apex Regional Landfill

Phone No. (702) 599-5920

Address: 13550 U.S. Hwy 93 Las Vegas, NV

I hereby acknowledge receipt of the above described materials (Signature) Name (Print or Type) Date Received

81 Environmental Tech
13550 N Highway 93
Las Vegas, NV 89165

Ticket Type: INBOUND INVOICE

Ticket Number: 1544
Date: 10/01/2010
Time In: 3:01 am
Time Out: 3:26 am

Customer: 001011 - NGE, LLC c/o Northgate Environ Mgmt

Vehicle/Container: 44166A
Contract: Northgate Env. On Site Soils 3825 11
Comment: 3825 10 11244

Gross Weight: 113,540 LB Manual In
Tare Weight: 55,960 LB Manual Out
Net Weight: 57,580 LB
Net Tons: 28.79

BOL: 11651

Origin	Yards	Material	Billing	Quantity
Not Applicable	0.00 YD	SW CONTAMINATED SOIL	28.79	TN

Driver: _____

Weighmaster: _____

SMITHJ

Indemnification. Customer agrees, by signature above, to indemnify, hold harmless, and defend Republic Services, Inc., its subsidiaries, affiliates, employees, officers and directors from and against any and all liabilities, claims, penalties, forfeitures, suits and the costs and expenses incident thereto, including costs of defense, settlement, and reasonable attorney's fees, which may be incurred, as a result of death or injuries to any person, or damage to any property, contamination of or adverse effects on the environment, caused in whole or in part by the Customer, its employees, or subcontractors in disposing waste at this Facility. In the event Customer delivers Unacceptable Waste (as determined by Republic) Customer agrees to assume all expenses and obligations with the removal and/or resolution of any effects caused by the delivery of such Unacceptable Waste.

Indemnización. Cliente acuerda indemnizar, mantener inmune, y defender Republic Services, Inc., sus subsidiarios, compañías, divisiones, empleados, oficiales y directores contra de cualquiera y de todas responsabilidades, demandas, penas, pérdidas, juicios, pleitos y los costos incidente además, incluyendo costos de defensa, de acuerdo judicial, y de honorarios razonables del abogado, que pueden ser incurridos en, o como resultado de, la muerte o herida personal a cualquier persona, o daños a cualquier característica, propiedad, contaminación de la tierra o efectos ilícitos en esta Facilidad, causado entero o en parte por el cliente, sus empleados, o sus subcontratistas en botar basura en esta Facilidad. En el caso que el Cliente entrega, bota, basura (según lo determinado por Republic) en este Establecimiento basura inaceptable en los reglamentos de este Establecimiento, el Cliente se compromete asumir todos los costos y obligaciones con el retiro y/o la resolución de cualquier dano(s) causado por la entrega de tal basura inaceptable.



NON-HAZARDOUS WASTE MANIFEST

MANIFEST # 11651

GENERATOR INFORMATION

Generator Name: Tronox LLC

Address: P.O. Box 55

City: Henderson County: Clark

State: NV Zip: 89009

Site Location (if different): 560 W. Lake Mead

Henderson, NV 89015 (702) 592-7727

CUSTOMER/BILLING INFORMATION

Billing Name: NGE LLC c/o Northgate Environment Management

Address: 300 Frank Ogawa Plaza, Ste 510

City: Oakland County: Alameda

State: CA Zip: 94612

Republic Services Approval #	Description of Waste	Volume/Weight	Expiration Date	Container Type
38251011244	Soil for disposal		12-31-2011	Tractor with Dump Trailer(s)
	RZ- _____ # _____	18.79 TN		

*Attach Additional Sheet if necessary

I hereby certify that the above-described materials are non-hazardous wastes as defined by 40 CFR 261 or any applicable state law. Further, that the above named materials are properly classified, described, packaged, marked and labeled, and are in proper condition for transportation according to the applicable regulations of the Department of Transportation.

Susan Crowley
Generator/Authorized Agent Name

Susan Crowley
Signature

Date Shipped

TRANSPORTER INFORMATION

Transporter Name: Las Vegas Paving

DOT # 191949

Address: 4420 S. Decatur

Truck Number: R0002

Las Vegas, NV 89103

Phone Number: (702) 353-4355

I certify no hazardous waste or other regulated substance was knowingly introduced to the waste while in my custody. The waste transported in this vehicle is the waste identified above, to the best of my knowledge.

Logan Carter
Name of Authorized Agent

Logan Carter
Signature

9-30-10
Date Delivered

DISPOSAL SITE INFORMATION

Site Name: Apex Regional Landfill

Phone No. (702) 599-5920

Address: 13550 U.S. Hwy 93 Las Vegas, NV

I hereby acknowledge receipt of the above described materials

Don Smith
Name (Print or Type)

Don Smith
Signature

9-1-10
Date Received

81 Environmental Tech
13550 N Highway 93
Las Vegas, NV 89165

Ticket Type: INBOUND INVOICE

Ticket Number: 1545
Date: 10/01/2010
Time In: 3:03 am
Time Out: 3:27 am

Customer: 001011 - NGE, LLC c/o Northgate Environ Mgmt

Vehicle/Container: 86113P
Contract: Northgate Env. On Site Soils 3825 11
Comment: 3825 10 11244

Gross Weight: 130,220 LB Manual In
Tare Weight: 55,980 LB Manual Out
Net Weight: 74240 LB
Net Tons: 37.12

BOL: 11652

Origin	Yards	Material	Billing	Quantity
Not Applicable	0.00 YD	SW CONTAMINATED SOIL	37.12	TN

Driver: _____

V. A. H.

Weighmaster: _____

SMITHJ

Indemnification. Customer agrees, by signature above, to indemnify, hold harmless, and defend Republic Services, Inc., its subsidiaries, affiliates, employees, officers and directors from and against any and all liabilities, claims, penalties, forfeitures, suits and the costs and expenses incident thereto, including costs of defense, settlement, and reasonable attorney's fees, which may be incurred, as a result of death or injuries to any person, or damage to any property, contamination of or adverse effects on the environment, caused in whole or in part by the Customer, its employees, or subcontractors in disposing waste at this Facility. In the event Customer delivers Unacceptable Waste (as determined by Republic) Customer agrees to assume all expenses and obligations with the removal and/or resolution of any effects caused by the delivery of such Unacceptable Waste.

Indemnización. Cliente acuerda indemnizar, mantener inmune, y defender Republic Services, Inc., sus subsidiarios, compañías, divisiones, empleados, oficiales y directores contra de cualquiera y de todas responsabilidades, demandas, penas, pérdidas, juicios, pleitos y los costos incidente además, incluyendo costos de defensa, de acuerdo judicial, y de honorarios razonables del abogado, que pueden ser incurridos en, o como resultado de, la muerte o herida personal a cualquier persona, o daños a cualquier característica, propiedad, contaminación de la tierra o efectos ilícitos en esta Facilidad, causado entero o en parte por el cliente, sus empleados, o sus subcontratistas en botar basura en esta Facilidad. En el caso que el Cliente entrega, bota, basura (según lo determinado por Republic) en este Establecimiento basura inaceptable en los reglamentos de este Establecimiento, el Cliente se compromete asumir todos los costos y obligaciones con el retiro y/o la resolución de cualquier dano(s) causado por la entrega de tal basura inaceptable.



NON-HAZARDOUS WASTE MANIFEST

MANIFEST # 11652

GENERATOR INFORMATION

Generator Name: Tronox LLC
Address: P.O. Box 55
City: Henderson County: Clark
State: NV Zip: 89009
Site Location (if different): 560 W. Lake Mead
Henderson, NV 89015 (702) 592-7727

CUSTOMER/BILLING INFORMATION

Billing Name: NGE LLC c/o Northgate Environment Management
Address: 300 Frank Ogawa Plaza, Ste 510
City: Oakland County: Alameda
State: CA Zip: 94612

Table with 5 columns: Republic Services Approval #, Description of Waste, Volume/Weight, Expiration Date, Container Type. Row 1: 38251011244, Soil for disposal, 37.12 TON, 12-31-2011, Tractor with Dump Trailer(s).

*Attach Additional Sheet if necessary

I hereby certify that the above-described materials are non-hazardous wastes as defined by 40 CFR 261 or any applicable state law. Further, that the above named materials are properly classified, described, packaged, marked and labeled, and are in proper condition for transportation according to the applicable regulations of the Department of Transportation.

Susan Crowley
Generator/Authorized Agent Name
Signature
Date Shipped

TRANSPORTER INFORMATION

Transporter Name: Las Vegas Paving DOT # 191949
Address: 4420 S. Decatur Truck Number: KMJA 19/7
Las Vegas, NV 89103 Phone Number: (702) 353-4355

I certify no hazardous waste or other regulated substance was knowingly introduced to the waste while in my custody. The waste transported in this vehicle is the waste identified above, to the best of my knowledge.

ALBERTO HERRERA
Name of Authorized Agent
Signature
Date Delivered: SEP 30, 2010

DISPOSAL SITE INFORMATION

Site Name: Apex Regional Landfill Phone No. (702) 599-5920
Address: 13550 U.S. Hwy 93 Las Vegas, NV

I hereby acknowledge receipt of the above described materials
Name (Print or Type) Signature Date Received: 10-1-10

81 Environmental Tech
13550 N Highway 93
Las Vegas, NV 89165

Ticket Type: INBOUND INVOICE

Ticket Number: 1546
Date: 10/01/2010
Time In: 3:11 am
Time Out: 3:36 am

Customer: 001011 - NGE, LLC c/o Northgate Environ Mgmt

Vehicle/Container: 20915A
Contract: Northgate Env. On Site Soils 3825 11
Comment: 3825 10 11244

Gross Weight: 124,320 LB Manual In
Tare Weight: 52,640 LB Manual Out
Net Weight: 71,680 LB
Net Tons: 35.84

BOL: 11654

Origin	Yards	Material	Billing	Quantity
Not Applicable	0.00 YD	SW CONTAMINATED SOIL	35.84	TN

Driver:



Weighmaster:

SMITHJ

Indemnification. Customer agrees, by signature above, to indemnify, hold harmless, and defend Republic Services, Inc., its subsidiaries, affiliates, employees, officers and directors from and against any and all liabilities, claims, penalties, forfeitures, suits and the costs and expenses incident thereto, including costs of defense, settlement, and reasonable attorney's fees, which may be incurred, as a result of death or injuries to any person, or damage to any property, contamination of or adverse effects on the environment, caused in whole or in part by the Customer, its employees, or subcontractors in disposing waste at this Facility. In the event Customer delivers Unacceptable Waste (as determined by Republic) Customer agrees to assume all expenses and obligations with the removal and/or resolution of any effects caused by the delivery of such Unacceptable Waste.

Indemnización. Cliente acuerda indemnizar, mantener inmune, y defender Republic Services, Inc., sus subsidiarios, compañías, divisiones, empleados, oficiales y directores contra de cualquiera y de todas responsabilidades, demandas, penas, pérdidas, juicios, pleitos y los costos incidente además, incluyendo costos de defensa, de acuerdo judicial, y de honorarios razonables del abogado, que pueden ser incurridos en, o como resultado de, la muerte o herida personal a cualquier persona, o daños a cualquier característica, propiedad, contaminación de la tierra o efectos ilícitos en esta Facilidad, causado entero o en parte por el cliente, sus empleados, o sus subcontratistas en botar basura en esta Facilidad. En el caso que el Cliente entrega, bota, basura (según lo determinado por Republic) en este Establecimiento basura inaceptable en los reglamentos de este Establecimiento, el Cliente se compromete asumir todos los costos y obligaciones con el retiro y/o la resolución de cualquier dano(s) causado por la entrega de tal basura inaceptable.



NON-HAZARDOUS WASTE MANIFEST

MANIFEST # 11654

GENERATOR INFORMATION

Generator Name: Tronox LLC

Address: P.O. Box 55

City: Henderson County: Clark

State: NV Zip: 89009

Site Location (if different): 560 W. Lake Mead

Henderson, NV 89015 (702) 592-7727

CUSTOMER/BILLING INFORMATION

Billing Name: NGE LLC c/o Northgate Environment Management

Address: 300 Frank Ogawa Plaza, Ste 510

City: Oakland County: Alameda

State: CA Zip: 94612

Republic Services Approval #	Description of Waste	Volume/Weight	Expiration Date	Container Type
38251011244	Soil for disposal		12-31-2011	Tractor with Dump Trailer(s)
	RZ- _____ # _____	35.84 TN		

*Attach Additional Sheet if necessary

I hereby certify that the above-described materials are non-hazardous wastes as defined by 40 CFR 261 or any applicable state law. Further, that the above named materials are properly classified, described, packaged, marked and labeled, and are in proper condition for transportation according to the applicable regulations of the Department of Transportation.

Susan Crowley (Signature) Date Shipped

TRANSPORTER INFORMATION

Transporter Name: Las Vegas Paving

DOT # 191949

Address: 4420 S. Decatur

Truck Number: 00

Las Vegas, NV 89103

Phone Number: (702) 353-4355

I certify no hazardous waste or other regulated substance was knowingly introduced to the waste while in my custody. The waste transported in this vehicle is the waste identified above, to the best of my knowledge.

TOM Sawling (Signature) Date Delivered 10-1-10

DISPOSAL SITE INFORMATION

Site Name: Apex Regional Landfill

Phone No. (702) 599-5920

Address: 13550 U.S. Hwy 93 Las Vegas, NV

I hereby acknowledge receipt of the above described materials

Jess Smith (Signature) Date Received 10-1-10

81 Environmental Tech
13550 N Highway 93
Las Vegas, NV 89165

Ticket Type: INBOUND INVOICE

Ticket Number: 1547
Date: 10/01/2010
Time In: 3:16 am
Time Out: 3:39 am

Customer: 001011 - NGE, LLC c/o Northgate Environ Mgmt

Vehicle/Container: 81494P
Contract: Northgate Env. On Site Soils 3825 11
Comment: 3825 10 11244

Gross Weight: 122,160 LB Manual In
Tare Weight: 50,160 LB Manual Out
Net Weight: 72000 LB
Net Tons: 36.00

BOL: 11655

Origin	Yards	Material	Billing	Quantity
Not Applicable	0.00 YD	SW CONTAMINATED SOIL	36.00	TN

Driver: _____



Weighmaster: _____

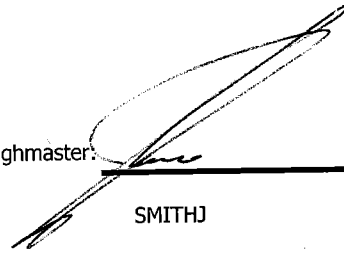

SMITHJ

Indemnification. Customer agrees, by signature above, to indemnify, hold harmless, and defend Republic Services, Inc., its subsidiaries, affiliates, employees, officers and directors from and against any and all liabilities, claims, penalties, forfeitures, suits and the costs and expenses incident thereto, including costs of defense, settlement, and reasonable attorney's fees, which may be incurred, as a result of death or injuries to any person, or damage to any property, contamination of or adverse effects on the environment, caused in whole or in part by the Customer, its employees, or subcontractors in disposing waste at this Facility. In the event Customer delivers Unacceptable Waste (as determined by Republic) Customer agrees to assume all expenses and obligations with the removal and/or resolution of any effects caused by the delivery of such Unacceptable Waste.

Indemnización. Cliente acuerda indemnizar, mantener inmune, y defender Republic Services, Inc., sus subsidiarios, compañías, divisiones, empleados, oficiales y directores contra de cualquiera y de todas responsabilidades, demandas, penas, pérdidas, juicios, pleitos y los costos incidente además, incluyendo costos de defensa, de acuerdo judicial, y de honorarios razonables del abogado, que pueden ser incurridos en, o como resultado de, la muerte o herida personal a cualquier persona, o daños a cualquier característica, propiedad, contaminación de la tierra o efectos ilícitos en esta Facilidad, causado entero o en parte por el cliente, sus empleados, o sus subcontratistas en botar basura en esta Facilidad. En el caso que el Cliente entrega, bota, basura (según lo determinado por Republic) en este Establecimiento basura inaceptable en los reglamentos de este Establecimiento, el Cliente se compromete asumir todos los costos y obligaciones con el retiro y/o la resolución de cualquier dano(s) causado por la entrega de tal basura inaceptable.



NON-HAZARDOUS WASTE MANIFEST

MANIFEST # 11655

GENERATOR INFORMATION

Generator Name: Tronox LLC

Address: P.O. Box 55

City: Henderson County: Clark

State: NV Zip: 89009

Site Location (if different): 560 W. Lake Mead

Henderson, NV 89015 (702) 592-7727

CUSTOMER/BILLING INFORMATION

Billing Name: NGE LLC c/o Northgate Environment Management

Address: 300 Frank Ogawa Plaza, Ste 510

City: Oakland County: Alameda

State: CA Zip: 94612

Republic Services Approval #	Description of Waste	Volume/Weight	Expiration Date	Container Type
38251011244	Soil for disposal		12-31-2011	Tractor with Dump Trailer(s)
	RZ- _____ # _____	3.00 TN		

*Attach Additional Sheet if necessary

I hereby certify that the above-described materials are non-hazardous wastes as defined by 40 CFR 261 or any applicable state law. Further, that the above named materials are properly classified, described, packaged, marked and labeled, and are in proper condition for transportation according to the applicable regulations of the Department of Transportation.

Susan Crowley Generator/Authorized Agent Name Signature Date Shipped

TRANSPORTER INFORMATION

Transporter Name: Las Vegas Paving

DOT # 191949

Address: 4420 S. Decatur

Truck Number: 25

Las Vegas, NV 89103

Phone Number: (702) 353-4355

I certify no hazardous waste or other regulated substance was knowingly introduced to the waste while in my custody. The waste transported in this vehicle is the waste identified above, to the best of my knowledge.

Colvin Pagayo Name of Authorized Agent Signature Date Delivered 9.30.10

DISPOSAL SITE INFORMATION

Site Name: Apex Regional Landfill

Phone No. (702) 599-5920

Address: 13550 U.S. Hwy 93 Las Vegas, NV

I hereby acknowledge receipt of the above described materials Name (Print or Type) Signature Date Received

81 Environmental Tech
13550 N Highway 93
Las Vegas, NV 89165

Ticket Type: INBOUND INVOICE

Ticket Number: 1548

Date: 10/01/2010

Time In: ~~3:35 am~~ 3:18 AM

Time Out: 3:41 am

Customer: 001011 - NGE, LLC c/o Northgate Environ Mgmt

Vehicle/Container: 76811P

Contract: Northgate Env. On Site Soils 3825 11

Comment: ~~242 3:16~~
3825 10 11244

Gross Weight: 127,480 LB Manual In
Tare Weight: 52,680 LB Manual Out
Net Weight: 74800 LB
Net Tons: 37.40

BOL: 11657

Origin	Yards	Material	Billing	Quantity
Not Applicable	0.00 YD	SW CONTAMINATED SOIL	37.40	TN

Driver: _____

Weighmaster: _____

SMITHJ

Indemnification. Customer agrees, by signature above, to indemnify, hold harmless, and defend Republic Services, Inc., its subsidiaries, affiliates, employees, officers and directors from and against any and all liabilities, claims, penalties, forfeitures, suits and the costs and expenses incident thereto, including costs of defense, settlement, and reasonable attorney's fees, which may be incurred, as a result of death or injuries to any person, or damage to any property, contamination of or adverse effects on the environment, caused in whole or in part by the Customer, its employees, or subcontractors in disposing waste at this Facility. In the event Customer delivers Unacceptable Waste (as determined by Republic) Customer agrees to assume all expenses and obligations with the removal and/or resolution of any effects caused by the delivery of such Unacceptable Waste.

Indemnización. Cliente acuerda indemnizar, mantener inmune, y defender Republic Services, Inc., sus subsidiarios, compañías, divisiones, empleados, oficiales y directores contra de cualquiera y de todas responsabilidades, demandas, penas, pérdidas, juicios, pleitos y los costos incidente además, incluyendo costos de defensa, de acuerdo judicial, y de honorarios razonables del abogado, que pueden ser incurridos en, o como resultado de, la muerte o herida personal a cualquier persona, o daños a cualquier característica, propiedad, contaminación de la tierra o efectos ilícitos en esta Facilidad, causado entero o en parte por el cliente, sus empleados, o sus subcontratistas en botar basura en esta Facilidad. En el caso que el Cliente entrega, bota, basura (según lo determinado por Republic) en este Establecimiento basura inaceptable en los reglamentos de este Establecimiento, el Cliente se compromete asumir todos los costos y obligaciones con el retiro y/o la resolución de cualquier dano(s) causado por la entrega de tal basura inaceptable.



NON-HAZARDOUS WASTE MANIFEST

MANIFEST # 11657

GENERATOR INFORMATION

Generator Name: Tronox LLC

Address: P.O. Box 55

City: Henderson County: Clark

State: NV Zip: 89009

Site Location (if different): 560 W. Lake Mead

Henderson, NV 89015 (702) 592-7727

CUSTOMER/BILLING INFORMATION

Billing Name: NGE LLC c/o Northgate Environment Management

Address: 300 Frank Ogawa Plaza, Ste 510

City: Oakland County: Alameda

State: CA Zip: 94612

Republic Services Approval #	Description of Waste	Volume/Weight	Expiration Date	Container Type
38251011244	Soil for disposal		12-31-2011	Tractor with Dump Trailer(s)
	RZ-_____ # _____	37.40 Tlb		

*Attach Additional Sheet if necessary

I hereby certify that the above-described materials are non-hazardous wastes as defined by 40 CFR 261 or any applicable state law. Further, that the above named materials are properly classified, described, packaged, marked and labeled, and are in proper condition for transportation according to the applicable regulations of the Department of Transportation.

Susan Crowley
Generator/Authorized Agent Name

[Signature]
Signature

Date Shipped

TRANSPORTER INFORMATION

Transporter Name: Las Vegas Paving

DOT # 191949

Address: 4420 S. Decatur

Truck Number: 242

Las Vegas, NV 89103

Phone Number: (702) 353-4355

I certify no hazardous waste or other regulated substance was knowingly introduced to the waste while in my custody. The waste transported in this vehicle is the waste identified above, to the best of my knowledge.

STEVE MAYE
Name of Authorized Agent

[Signature]
Signature

9-30-10
Date Delivered

DISPOSAL SITE INFORMATION

Site Name: Apex Regional Landfill

Phone No. (702) 599-5920

Address: 13550 U.S. Hwy 93 Las Vegas, NV

I hereby acknowledge receipt of the above described materials

[Signature]
Name (Print or Type)

[Signature]
Signature

10-1-10
Date Received

81 Environmental Tech
13550 N Highway 93
Las Vegas, NV 89165

Ticket Type: INBOUND INVOICE

Ticket Number: 1549
Date: 10/01/2010
Time In: 3:20 am
Time Out: 3:43 am

Customer: 001011 - NGE, LLC c/o Northgate Environ Mgmt

Vehicle/Container: 81460P
Contract: Northgate Env. On Site Soils 3825 11
Comment: 3825 10 11244

Gross Weight: 125,980 LB Manual In
Tare Weight: 51,760 LB Manual Out
Net Weight: 74220 LB
Net Tons: 37.11

BOL: 11656

Origin	Yards	Material	Billing	Quantity
Not Applicable	0.00 YD	SW CONTAMINATED SOIL	37.11	TN

Driver: _____

Weighmaster: _____

SMITHJ

Indemnification. Customer agrees, by signature above, to indemnify, hold harmless, and defend Republic Services, Inc., its subsidiaries, affiliates, employees, officers and directors from and against any and all liabilities, claims, penalties, forfeitures, suits and the costs and expenses incident thereto, including costs of defense, settlement, and reasonable attorney's fees, which may be incurred, as a result of death or injuries to any person, or damage to any property, contamination of or adverse effects on the environment, caused in whole or in part by the Customer, its employees, or subcontractors in disposing waste at this Facility. In the event Customer delivers Unacceptable Waste (as determined by Republic) Customer agrees to assume all expenses and obligations with the removal and/or resolution of any effects caused by the delivery of such Unacceptable Waste.

Indemnización. Cliente acuerda indemnizar, mantener inmune, y defender Republic Services, Inc., sus subsidiarios, compañías, divisiones, empleados, oficiales y directores contra de cualquiera y de todas responsabilidades, demandas, penas, pérdidas, juicios, pleitos y los costos incidente además, incluyendo costos de defensa, de acuerdo judicial, y de honorarios razonables del abogado, que pueden ser incurridos en, o como resultado de, la muerte o herida personal a cualquier persona, o daños a cualquier característica, propiedad, contaminación de la tierra o efectos ilícitos en esta Facilidad, causado entero o en parte por el cliente, sus empleados, o sus subcontratistas en botar basura en esta Facilidad. En el caso que el Cliente entrega, bota, basura (según lo determinado por Republic) en este Establecimiento basura inaceptable en los reglamentos de este Establecimiento, el Cliente se compromete asumir todos los costos y obligaciones con el retiro y/o la resolución de cualquier dano(s) causado por la entrega de tal basura inaceptable.



NON-HAZARDOUS WASTE MANIFEST

MANIFEST # 11656

GENERATOR INFORMATION

Generator Name: Tronox LLC

Address: P.O. Box 55

City: Henderson County: Clark

State: NV Zip: 89009

Site Location (if different): 560 W. Lake Mead

Henderson, NV 89015 (702) 592-7727

CUSTOMER/BILLING INFORMATION

Billing Name: NGE LLC c/o Northgate Environment Management

Address: 300 Frank Ogawa Plaza, Ste 510

City: Oakland County: Alameda

State: CA Zip: 94612

Table with 5 columns: Republic Services Approval #, Description of Waste, Volume/Weight, Expiration Date, Container Type. Row 1: 38251011244, Soil for disposal, 37.11 TON, 12-31-2011, Tractor with Dump Trailer(s).

*Attach Additional Sheet if necessary

I hereby certify that the above-described materials are non-hazardous wastes as defined by 40 CFR 261 or any applicable state law. Further, that the above named materials are properly classified, described, packaged, marked and labeled, and are in proper condition for transportation according to the applicable regulations of the Department of Transportation.

Susan Crowley (Signature) Generator/Authorized Agent Name Signature Date Shipped

TRANSPORTER INFORMATION

Transporter Name: Las Vegas Paving

DOT # 191949

Address: 4420 S. Decatur

Truck Number: 27

Las Vegas, NV 89103

Phone Number: (702) 353-4355

I certify no hazardous waste or other regulated substance was knowingly introduced to the waste while in my custody. The waste transported in this vehicle is the waste identified above, to the best of my knowledge.

Daniel Cardena (Signature) Name of Authorized Agent Signature Date Delivered 9/30/2010

DISPOSAL SITE INFORMATION

Site Name: Apex Regional Landfill

Phone No. (702) 599-5920

Address: 13550 U.S. Hwy 93 Las Vegas, NV

I hereby acknowledge receipt of the above described materials Name (Print or Type) Signature Date Received 10-1-10

81 Environmental Tech
13550 N Highway 93
Las Vegas, NV 89165

Ticket Type: INBOUND INVOICE

Ticket Number: 1550
Date: 10/01/2010
Time In: 3:22 am
Time Out: 3:44 am

Customer: 001011 - NGE, LLC c/o Northgate Environ Mgmt

Vehicle/Container: 84598P
Contract: Northgate Env. On Site Soils 3825 11
Comment: 3825 10 11244

Gross Weight: 125,880 LB Manual In
Tare Weight: 52,120 LB Manual Out
Net Weight: 73760 LB
Net Tons: 36.88

BOL: 11658

Origin	Yards	Material	Billing	Quantity
Not Applicable	0.00 YD	SW CONTAMINATED SOIL	36.88	TN

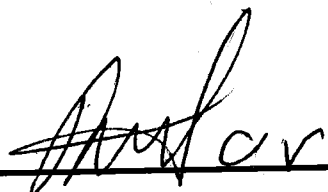
Driver: 

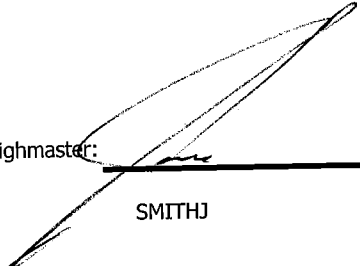
Weighmaster: 
SMITHJ

Indemnification. Customer agrees, by signature above, to indemnify, hold harmless, and defend Republic Services, Inc., its subsidiaries, affiliates, employees, officers and directors from and against any and all liabilities, claims, penalties, forfeitures, suits and the costs and expenses incident thereto, including costs of defense, settlement, and reasonable attorney's fees, which may be incurred, as a result of death or injuries to any person, or damage to any property, contamination of or adverse effects on the environment, caused in whole or in part by the Customer, its employees, or subcontractors in disposing waste at this Facility. In the event Customer delivers Unacceptable Waste (as determined by Republic) Customer agrees to assume all expenses and obligations with the removal and/or resolution of any effects caused by the delivery of such Unacceptable Waste.

Indemnización. Cliente acuerda indemnizar, mantener inmune, y defender Republic Services, Inc., sus subsidiarios, companias, divisiones, empleados, oficiales y directores contra de cualquiera y de todas responsabilidades, demandas, penas, pérdidas, juicios, pleitos y los costos incidente además, incluyendo costos de defensa, de acuerdo judicial, y de honorarios razonables del abogado, que pueden ser incurridos en, o como resultado de, la muerte o herida personal a cualquier persona, o daños a cualquier característica, propiedad, contaminación de la tierra o efectos ilicitos en esta Facilidad, causado entero o en parte por el cliente, sus empleados, o sus subcontratistas en botar basura en esta Facilidad. En el caso que el Cliente entrega, bota, basura (según lo determinado por Republic) en este Establecimiento basura inaceptable en los reglamentos de este Establecimiento, el Cliente se compromete asumir todos los costos y obligaciones con el retiro y/o la resolución de cualquier dano(s) causado por la entrega de tal basura inaceptable.



NON-HAZARDOUS WASTE MANIFEST

MANIFEST # 11658

GENERATOR INFORMATION

Generator Name: Tronox LLC

Address: P.O. Box 55

City: Henderson County: Clark

State: NV Zip: 89009

Site Location (if different): 560 W. Lake Mead

Henderson, NV 89015 (702) 592-7727

CUSTOMER/BILLING INFORMATION

Billing Name: NGE LLC c/o Northgate Environment Management

Address: 300 Frank Ogawa Plaza, Ste 510

City: Oakland County: Alameda

State: CA Zip: 94612

Republic Services Approval #	Description of Waste	Volume/Weight	Expiration Date	Container Type
38251011244	Soil for disposal		12-31-2011	Tractor with Dump Trailer(s)
	RZ- _____ # _____	<u>26.88</u> <u>70</u>		

*Attach Additional Sheet if necessary

I hereby certify that the above-described materials are non-hazardous wastes as defined by 40 CFR 261 or any applicable state law. Further, that the above named materials are properly classified, described, packaged, marked and labeled, and are in proper condition for transportation according to the applicable regulations of the Department of Transportation.

Susan Crowley
Generator/Authorized Agent Name

[Signature]
Signature

Date Shipped

TRANSPORTER INFORMATION

Transporter Name: Las Vegas Paving

DOT # 191949

Address: 4420 S. Decatur

Truck Number: 28

Las Vegas, NV 89103

Phone Number: (702) 353-4355

I certify no hazardous waste or other regulated substance was knowingly introduced to the waste while in my custody. The waste transported in this vehicle is the waste identified above, to the best of my knowledge.

KRANG
Name of Authorized Agent

[Signature]
Signature

10-01-10
Date Delivered

DISPOSAL SITE INFORMATION

Site Name: Apex Regional Landfill

Phone No. (702) 599-5920

Address: 13550 U.S. Hwy 93 Las Vegas, NV

I hereby acknowledge receipt of the above described materials

[Signature]
Name (Print or Type)

Signature

10-1-10
Date Received

81 Environmental Tech
13550 N Highway 93
Las Vegas, NV 89165

Ticket Type: INBOUND INVOICE

Ticket Number: 1551
Date: 10/01/2010
Time In: 3:24 am
Time Out: 3:46 am

Customer: 001011 - NGE, LLC c/o Northgate Environ Mgmt

Vehicle/Container: 86053P
Contract: Northgate Env. On Site Soils 3825 11
Comment: 3825 10 11244

Gross Weight: 128,800 LB Manual In
Tare Weight: 55,620 LB Manual Out
Net Weight: 73180 LB
Net Tons: 36.59

BOL: 11653

Origin	Yards	Material	Billing	Quantity
Not Applicable	0.00 YD	SW CONTAMINATED SOIL	36.59	TN

Driver: _____



Weighmaster: _____

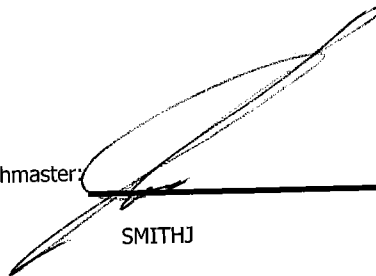

SMITHJ

Indemnification. Customer agrees, by signature above, to indemnify, hold harmless, and defend Republic Services, Inc., its subsidiaries, affiliates, employees, officers and directors from and against any and all liabilities, claims, penalties, forfeitures, suits and the costs and expenses incident thereto, including costs of defense, settlement, and reasonable attorney's fees, which may be incurred, as a result of death or injuries to any person, or damage to any property, contamination of or adverse effects on the environment, caused in whole or in part by the Customer, its employees, or subcontractors in disposing waste at this Facility. In the event Customer delivers Unacceptable Waste (as determined by Republic) Customer agrees to assume all expenses and obligations with the removal and/or resolution of any effects caused by the delivery of such Unacceptable Waste.

Indemnización. Cliente acuerda indemnizar, mantener inmune, y defender Republic Services, Inc., sus subsidiarios, compañías, divisiones, empleados, oficiales y directores contra de cualquiera y de todas responsabilidades, demandas, penas, pérdidas, juicios, pleitos y los costos incidente además, incluyendo costos de defensa, de acuerdo judicial, y de honorarios razonables del abogado, que pueden ser incurridos en, o como resultado de, la muerte o herida personal a cualquier persona, o daños a cualquier característica, propiedad, contaminación de la tierra o efectos ilícitos en esta Facilidad, causado entero o en parte por el cliente, sus empleados, o sus subcontratistas en botar basura en esta Facilidad. En el caso que el Cliente entrega, bota, basura (según lo determinado por Republic) en este Establecimiento basura inaceptable en los reglamentos de este Establecimiento, el Cliente se compromete asumir todos los costos y obligaciones con el retiro y/o la resolución de cualquier dano(s) causado por la entrega de tal basura inaceptable.



NON-HAZARDOUS WASTE MANIFEST

MANIFEST # 11653

GENERATOR INFORMATION

Generator Name: Tronox LLC
 Address: P.O. Box 55
 City: Henderson County: Clark
 State: NV Zip: 89009
 Site Location (if different): 560 W. Lake Mead
Henderson, NV 89015 (702) 592-7727

CUSTOMER/BILLING INFORMATION

Billing Name: NGE LLC c/o Northgate Environment Management
 Address: 300 Frank Ogawa Plaza, Ste 510
 City: Oakland County: Alameda
 State: CA Zip: 94612

Republic Services Approval #	Description of Waste	Volume/Weight	Expiration Date	Container Type
38251011244	Soil for disposal		12-31-2011	Tractor with Dump Trailer(s)
	RZ- _____ # _____	36.5970		

*Attach Additional Sheet if necessary

I hereby certify that the above-described materials are non-hazardous wastes as defined by 40 CFR 261 or any applicable state law. Further, that the above named materials are properly classified, described, packaged, marked and labeled, and are in proper condition for transportation according to the applicable regulations of the Department of Transportation.

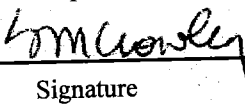
Susan Crowley 
 Generator/Authorized Agent Name Signature Date Shipped

TRANSPORTER INFORMATION

Transporter Name: Las Vegas Paving DOT # 191949
 Address: 4420 S. Decatur Truck Number: 261
Las Vegas, NV 89103 Phone Number: (702) 353-4355

I certify no hazardous waste or other regulated substance was knowingly introduced to the waste while in my custody. The waste transported in this vehicle is the waste identified above, to the best of my knowledge.

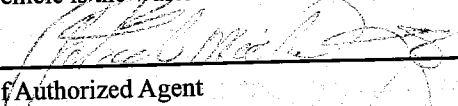
 Patrick White 28 SEP 10
 Name of Authorized Agent Signature Date Delivered

DISPOSAL SITE INFORMATION

Site Name: Apex Regional Landfill Phone No. (702) 599-5920
 Address: 13550 U.S. Hwy 93 Las Vegas, NV

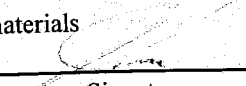
I hereby acknowledge receipt of the above described materials
Josiah Smith 
 Name (Print or Type) Signature Date Received 10-1-10

81 Environmental Tech
13550 N Highway 93
Las Vegas, NV 89165

Ticket Type: INBOUND INVOICE

Ticket Number: 1552
Date: 10/01/2010
Time In: 3:24 am
Time Out: 3:49 am

Customer: 001011 - NGE, LLC c/o Northgate Environ Mgmt

Vehicle/Container: 85940P
Contract: Northgate Env. On Site Soils 3825 11
Comment: 3825 10 11244

Gross Weight: 125,240 LB Manual In
Tare Weight: 48,640 LB Manual Out
Net Weight: 76600 LB
Net Tons: 38.30

BOL: 11659

Origin	Yards	Material	Billing	Quantity
Not Applicable	0.00 YD	SW CONTAMINATED SOIL	38.30	TN

Driver:

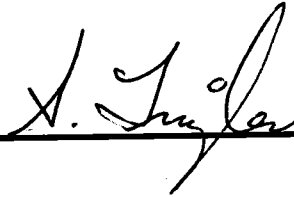

Weighmaster:

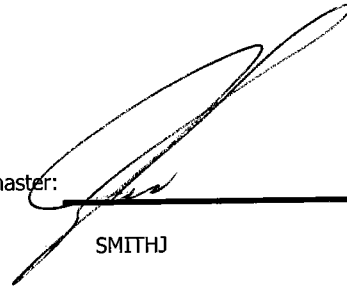
SMITHJ

Indemnification. Customer agrees, by signature above, to indemnify, hold harmless, and defend Republic Services, Inc., its subsidiaries, affiliates, employees, officers and directors from and against any and all liabilities, claims, penalties, forfeitures, suits and the costs and expenses incident thereto, including costs of defense, settlement, and reasonable attorney's fees, which may be incurred, as a result of death or injuries to any person, or damage to any property, contamination of or adverse effects on the environment, caused in whole or in part by the Customer, its employees, or subcontractors in disposing waste at this Facility. In the event Customer delivers Unacceptable Waste (as determined by Republic) Customer agrees to assume all expenses and obligations with the removal and/or resolution of any effects caused by the delivery of such Unacceptable Waste.

Indemnización. Cliente acuerda indemnizar, mantener inmune, y defender Republic Services, Inc., sus subsidiarios, compañías, divisiones, empleados, oficiales y directores contra de cualquiera y de todas responsabilidades, demandas, penas, pérdidas, juicios, pleitos y los costos incidente además, incluyendo costos de defensa, de acuerdo judicial, y de honorarios razonables del abogado, que pueden ser incurridos en, o como resultado de, la muerte o herida personal a cualquier persona, o daños a cualquier característica, propiedad, contaminación de la tierra o efectos ilícitos en esta Facilidad, causado entero o en parte por el cliente, sus empleados, o sus subcontratistas en botar basura en esta Facilidad. En el caso que el Cliente entrega, bota, basura (según lo determinado por Republic) en este Establecimiento basura inaceptable en los reglamentos de este Establecimiento, el Cliente se compromete asumir todos los costos y obligaciones con el retiro y/o la resolución de cualquier dano(s) causado por la entrega de tal basura inaceptable.



NON-HAZARDOUS WASTE MANIFEST

MANIFEST # 11659

GENERATOR INFORMATION

Generator Name: Tronox LLCAddress: P.O. Box 55City: Henderson County: ClarkState: NV Zip: 89009Site Location (if different): 560 W. Lake MeadHenderson, NV 89015 (702) 592-7727

CUSTOMER/BILLING INFORMATION

Billing Name: NGE LLC c/o Northgate Environment ManagementAddress: 300 Frank Ogawa Plaza, Ste 510City: Oakland County: AlamedaState: CA Zip: 94612

Republic Services Approval #	Description of Waste	Volume/Weight	Expiration Date	Container Type
38251011244	Soil for disposal		12-31-2011	Tractor with Dump Trailer(s)
	RZ- _____ # _____	38.30 TN		

*Attach Additional Sheet if necessary

I hereby certify that the above-described materials are non-hazardous wastes as defined by 40 CFR 261 or any applicable state law. Further, that the above named materials are properly classified, described, packaged, marked and labeled, and are in proper condition for transportation according to the applicable regulations of the Department of Transportation.

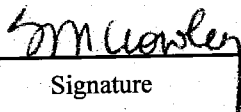
Susan Crowley 
 Generator/Authorized Agent Name Signature Date Shipped

TRANSPORTER INFORMATION

Transporter Name: Las Vegas PavingDOT # 191949Address: 4420 S. DecaturTruck Number: 06Las Vegas, NV 89103Phone Number: (702) 353-4355

I certify no hazardous waste or other regulated substance was knowingly introduced to the waste while in my custody. The waste transported in this vehicle is the waste identified above, to the best of my knowledge.

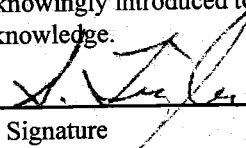
TRICKER, STEVE 
 Name of Authorized Agent Signature Date Delivered 9.30.10

DISPOSAL SITE INFORMATION

Site Name: Apex Regional LandfillPhone No. (702) 599-5920Address: 13550 U.S. Hwy 93 Las Vegas, NV

I hereby acknowledge receipt of the above described materials

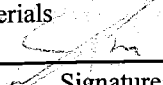
For Site Entry 
 Name (Print or Type) Signature Date Received 10/1/10

81 Environmental Tech
13550 N Highway 93
Las Vegas, NV 89165

Ticket Type: INBOUND INVOICE

Ticket Number: 1553
Date: 10/01/2010
Time In: ~~3:18 am~~ 3:30 AM
Time Out: 4:05 am

Customer: 001011 - NGE, LLC c/o Northgate Environ Mgmt

Vehicle/Container: 68263P
Contract: Northgate Env. On Site Soils 3825 11
Comment: 3825 10 11244

Gross Weight: 130,360 LB Manual In
Tare Weight: 53,180 LB Manual Out
Net Weight: 77180 LB
Net Tons: 38.59

BOL: 11660

Origin	Yards	Material	Billing	Quantity
Not Applicable	0.00 YD	SW CONTAMINATED SOIL	38.59 TN	

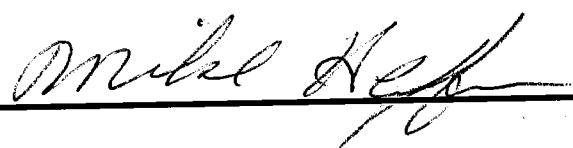
Driver: 

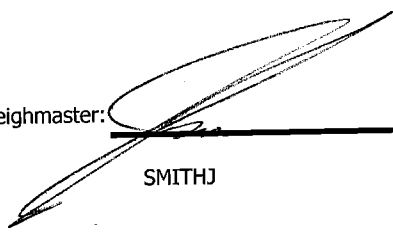
Weighmaster: 
SMITHJ

Indemnification. Customer agrees, by signature above, to indemnify, hold harmless, and defend Republic Services, Inc., its subsidiaries, affiliates, employees, officers and directors from and against any and all liabilities, claims, penalties, forfeitures, suits and the costs and expenses incident thereto, including costs of defense, settlement, and reasonable attorney's fees, which may be incurred, as a result of death or injuries to any person, or damage to any property, contamination of or adverse effects on the environment, caused in whole or in part by the Customer, its employees, or subcontractors in disposing waste at this Facility. In the event Customer delivers Unacceptable Waste (as determined by Republic) Customer agrees to assume all expenses and obligations with the removal and/or resolution of any effects caused by the delivery of such Unacceptable Waste.

Indemnización. Cliente acuerda indemnizar, mantener inmune, y defender Republic Services, Inc., sus subsidiarios, compañías, divisiones, empleados, oficiales y directores contra de cualquiera y de todas responsabilidades, demandas, penas, pérdidas, juicios, pleitos y los costos incidente además, incluyendo costos de defensa, de acuerdo judicial, y de honorarios razonables del abogado, que pueden ser incurridos en, o como resultado de, la muerte o herida personal a cualquier persona, o daños a cualquier característica, propiedad, contaminación de la tierra o efectos ilícitos en esta Facilidad, causado entero o en parte por el cliente, sus empleados, o sus subcontratistas en botar basura en esta Facilidad. En el caso que el Cliente entrega, bota, basura (según lo determinado por Republic) en este Establecimiento basura inaceptable en los reglamentos de este Establecimiento, el Cliente se compromete asumir todos los costos y obligaciones con el retiro y/o la resolución de cualquier dano(s) causado por la entrega de tal basura inaceptable.



NON-HAZARDOUS WASTE MANIFEST

MANIFEST # 11660

GENERATOR INFORMATION

Generator Name: Tronox LLC

Address: P.O. Box 55

City: Henderson County: Clark

State: NV Zip: 89009

Site Location (if different): 560 W. Lake Mead

Henderson, NV 89015 (702) 592-7727

CUSTOMER/BILLING INFORMATION

Billing Name: NGE LLC c/o Northgate Environment Management

Address: 300 Frank Ogawa Plaza, Ste 510

City: Oakland County: Alameda

State: CA Zip: 94612

Republic Services Approval #	Description of Waste	Volume/Weight	Expiration Date	Container Type
38251011244	Soil for disposal		12-31-2011	Tractor with Dump Trailer(s)
	RZ- _____ # _____	30.59 70		

*Attach Additional Sheet if necessary

I hereby certify that the above-described materials are non-hazardous wastes as defined by 40 CFR 261 or any applicable state law. Further, that the above named materials are properly classified, described, packaged, marked and labeled, and are in proper condition for transportation according to the applicable regulations of the Department of Transportation.

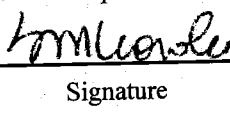
Susan Crowley 
 Generator/Authorized Agent Name Signature Date Shipped

TRANSPORTER INFORMATION

Transporter Name: Las Vegas Paving

DOT # 191949

Address: 4420 S. Decatur

Truck Number: 2711

Las Vegas, NV 89103

Phone Number: (702) 353-4355

I certify no hazardous waste or other regulated substance was knowingly introduced to the waste while in my custody. The waste transported in this vehicle is the waste identified above, to the best of my knowledge.

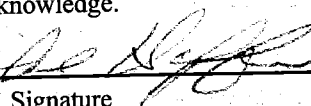
Mike Hartman 
 Name of Authorized Agent Signature Date Delivered 9-30-10

DISPOSAL SITE INFORMATION

Site Name: Apex Regional Landfill

Phone No. (702) 599-5920

Address: 13550 U.S. Hwy 93 Las Vegas, NV

I hereby acknowledge receipt of the above described materials
Jesse Smith
 Name (Print or Type) Signature Date Received

81 Environmental Tech
13550 N Highway 93
Las Vegas, NV 89165

Ticket Type: INBOUND INVOICE

Ticket Number: 1554
Date: 10/01/2010
Time In: 3:32 am
Time Out: 4:07 am

Customer: 001011 - NGE, LLC c/o Northgate Environ Mgmt

Vehicle/Container: 81496P
Contract: Northgate Env. On Site Soils 3825 11
Comment: 3825 10 11244

Gross Weight: 124,280 LB Manual In
Tare Weight: 50,160 LB Manual Out
Net Weight: 74,120 LB
Net Tons: 37.06

BOL: 11661

Origin	Yards	Material	Billing	Quantity
Not Applicable	0.00 YD	SW CONTAMINATED SOIL	37.06	TN

Driver:



Weighmaster:

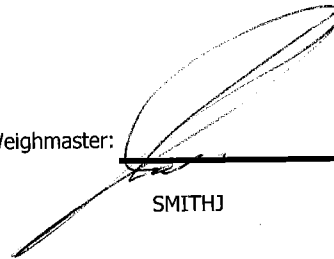

SMITHJ

Indemnification. Customer agrees, by signature above, to indemnify, hold harmless, and defend Republic Services, Inc., its subsidiaries, affiliates, employees, officers and directors from and against any and all liabilities, claims, penalties, forfeitures, suits and the costs and expenses incident thereto, including costs of defense, settlement, and reasonable attorney's fees, which may be incurred, as a result of death or injuries to any person, or damage to any property, contamination of or adverse effects on the environment, caused in whole or in part by the Customer, its employees, or subcontractors in disposing waste at this Facility. In the event Customer delivers Unacceptable Waste (as determined by Republic) Customer agrees to assume all expenses and obligations with the removal and/or resolution of any effects caused by the delivery of such Unacceptable Waste.

Indemnización. Cliente acuerda indemnizar, mantener inmune, y defender Republic Services, Inc., sus subsidiarios, compañías, divisiones, empleados, oficiales y directores contra de cualquiera y de todas responsabilidades, demandas, penas, pérdidas, juicios, pleitos y los costos incidente además, incluyendo costos de defensa, de acuerdo judicial, y de honorarios razonables del abogado, que pueden ser incurridos en, o como resultado de, la muerte o herida personal a cualquier persona, o daños a cualquier característica, propiedad, contaminación de la tierra o efectos ilícitos en esta Facilidad, causado entero o en parte por el cliente, sus empleados, o sus subcontratistas en botar basura en esta Facilidad. En el caso que el Cliente entrega, bota, basura (según lo determinado por Republic) en este Establecimiento basura inaceptable en los reglamentos de este Establecimiento, el Cliente se compromete asumir todos los costos y obligaciones con el retiro y/o la resolución de cualquier dano(s) causado por la entrega de tal basura inaceptable.



NON-HAZARDOUS WASTE MANIFEST

MANIFEST # 11661

GENERATOR INFORMATION

Generator Name: Tronox LLC
Address: P.O. Box 55
City: Henderson County: Clark
State: NV Zip: 89009
Site Location (if different): 560 W. Lake Mead
Henderson, NV 89015 (702) 592-7727

CUSTOMER/BILLING INFORMATION

Billing Name: NGE LLC c/o Northgate Environment Management
Address: 300 Frank Ogawa Plaza, Ste 510
City: Oakland County: Alameda
State: CA Zip: 94612

Table with 5 columns: Republic Services Approval #, Description of Waste, Volume/Weight, Expiration Date, Container Type. Row 1: 38251011244, Soil for disposal, 37.06 TON, 12-31-2011, Tractor with Dump Trailer(s)

*Attach Additional Sheet if necessary

I hereby certify that the above-described materials are non-hazardous wastes as defined by 40 CFR 261 or any applicable state law. Further, that the above named materials are properly classified, described, packaged, marked and labeled, and are in proper condition for transportation according to the applicable regulations of the Department of Transportation.

Susan Crowley
Generator/Authorized Agent Name Signature Date Shipped

TRANSPORTER INFORMATION

Transporter Name: Las Vegas Paving DOT # 191949
Address: 4420 S. Decatur Truck Number: 143
Las Vegas, NV 89103 Phone Number: (702) 353-4355

I certify no hazardous waste or other regulated substance was knowingly introduced to the waste while in my custody. The waste transported in this vehicle is the waste identified above, to the best of my knowledge.

Harry M. G... Signature Date Delivered 9-29-10
Name of Authorized Agent Signature Date Delivered

DISPOSAL SITE INFORMATION

Site Name: Apex Regional Landfill Phone No. (702) 599-5920
Address: 13550 U.S. Hwy 93 Las Vegas, NV

I hereby acknowledge receipt of the above described materials
Name (Print or Type) Signature Date Received

81 Environmental Tech
13550 N Highway 93
Las Vegas, NV 89165

Ticket Type: INBOUND INVOICE

Ticket Number: 1555
Date: 10/01/2010
Time In: 3:50 am
Time Out: 4:20 am

Customer: 001011 - NGE, LLC c/o Northgate Environ Mgmt

Vehicle/Container: 192456
Contract: Northgate Env. On Site Soils 3825 11
Comment: 3825 10 11244

Gross Weight: 126,400 LB Manual In
Tare Weight: 52,840 LB Manual Out
Net Weight: 73560 LB
Net Tons: 36.78

BOL: 11663

Origin	Yards	Material	Billing	Quantity
Not Applicable	0.00 YD	SW CONTAMINATED SOIL	36.78	TN

Driver: _____



Weighmaster: _____

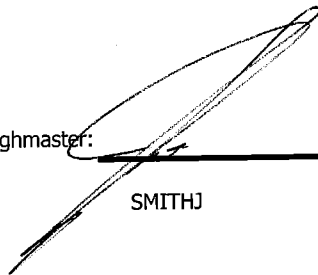

SMITHJ

Indemnification. Customer agrees, by signature above, to indemnify, hold harmless, and defend Republic Services, Inc., its subsidiaries, affiliates, employees, officers and directors from and against any and all liabilities, claims, penalties, forfeitures, suits and the costs and expenses incident thereto, including costs of defense, settlement, and reasonable attorney's fees, which may be incurred, as a result of death or injuries to any person, or damage to any property, contamination of or adverse effects on the environment, caused in whole or in part by the Customer, its employees, or subcontractors in disposing waste at this Facility. In the event Customer delivers Unacceptable Waste (as determined by Republic) Customer agrees to assume all expenses and obligations with the removal and/or resolution of any effects caused by the delivery of such Unacceptable Waste.

Indemnización. Cliente acuerda indemnizar, mantener inmune, y defender Republic Services, Inc., sus subsidiarios, compañías, divisiones, empleados, oficiales y directores contra de cualquiera y de todas responsabilidades, demandas, penas, pérdidas, juicios, pleitos y los costos incidente además, incluyendo costos de defensa, de acuerdo judicial, y de honorarios razonables del abogado, que pueden ser incurridos en, o como resultado de, la muerte o herida personal a cualquier persona, o daños a cualquier característica, propiedad, contaminación de la tierra o efectos ilícitos en esta Facilidad, causado entero o en parte por el cliente, sus empleados, o sus subcontratistas en botar basura en esta Facilidad. En el caso que el Cliente entrega, bota, basura (según lo determinado por Republic) en este Establecimiento basura inaceptable en los reglamentos de este Establecimiento, el Cliente se compromete asumir todos los costos y obligaciones con el retiro y/o la resolución de cualquier dano(s) causado por la entrega de tal basura inaceptable.



NON-HAZARDOUS WASTE MANIFEST

MANIFEST # 11663

GENERATOR INFORMATION

Generator Name: Tronox LLC

Address: P.O. Box 55

City: Henderson County: Clark

State: NV Zip: 89009

Site Location (if different): 560 W. Lake Mead

Henderson, NV 89015 (702) 592-7727

CUSTOMER/BILLING INFORMATION

Billing Name: NGE LLC c/o Northgate Environment Management

Address: 300 Frank Ogawa Plaza, Ste 510

City: Oakland County: Alameda

State: CA Zip: 94612

Table with 5 columns: Republic Services Approval #, Description of Waste, Volume/Weight, Expiration Date, Container Type. Row 1: 38251011244, Soil for disposal, 36.78 TN, 12-31-2011, Tractor with Dump Trailer(s).

*Attach Additional Sheet if necessary

I hereby certify that the above-described materials are non-hazardous wastes as defined by 40 CFR 261 or any applicable state law. Further, that the above named materials are properly classified, described, packaged, marked and labeled, and are in proper condition for transportation according to the applicable regulations of the Department of Transportation.

Susan Crowley (Signature) Generator/Authorized Agent Name Date Shipped

TRANSPORTER INFORMATION

Transporter Name: Las Vegas Paving

DOT # 191949

Address: 4420 S. Decatur

Truck Number: 192456

Las Vegas, NV 89103

Phone Number: (702) 353-4355

I certify no hazardous waste or other regulated substance was knowingly introduced to the waste while in my custody. The waste transported in this vehicle is the waste identified above, to the best of my knowledge.

Bla (Signature) Name of Authorized Agent Date Delivered

DISPOSAL SITE INFORMATION

Site Name: Apex Regional Landfill

Phone No. (702) 599-5920

Address: 13550 U.S. Hwy 93 Las Vegas, NV

I hereby acknowledge receipt of the above described materials (Signature) Name (Print or Type) Date Received

81 Environmental Tech
13550 N Highway 93
Las Vegas, NV 89165

Ticket Type: INBOUND INVOICE

Ticket Number: 1556
Date: 10/01/2010
Time In: 3:55 am
Time Out: 4:22 am

Customer: 001011 - NGE, LLC c/o Northgate Environ Mgmt

Vehicle/Container: 192457
Contract: Northgate Env. On Site Soils 3825 11
Comment: 3825 10 11244

Gross Weight: 119,980 LB Manual In
Tare Weight: 51,680 LB Manual Out
Net Weight: 68300 LB
Net Tons: 34.15

BOL: 11664

Origin	Yards	Material	Billing	Quantity
Not Applicable	0.00 YD	SW CONTAMINATED SOIL	34.15	TN

Driver: 

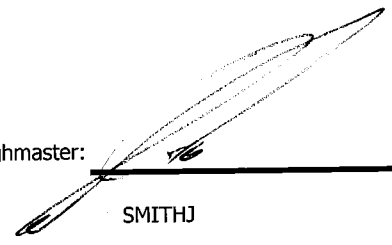
Weighmaster: 
SMITHJ

Indemnification. Customer agrees, by signature above, to indemnify, hold harmless, and defend Republic Services, Inc., its subsidiaries, affiliates, employees, officers and directors from and against any and all liabilities, claims, penalties, forfeitures, suits and the costs and expenses incident thereto, including costs of defense, settlement, and reasonable attorney's fees, which may be incurred, as a result of death or injuries to any person, or damage to any property, contamination of or adverse effects on the environment, caused in whole or in part by the Customer, its employees, or subcontractors in disposing waste at this Facility. In the event Customer delivers Unacceptable Waste (as determined by Republic) Customer agrees to assume all expenses and obligations with the removal and/or resolution of any effects caused by the delivery of such Unacceptable Waste.

Indemnización. Cliente acuerda indemnizar, mantener inmune, y defender Republic Services, Inc., sus subsidiarios, compañías, divisiones, empleados, oficiales y directores contra de cualquiera y de todas responsabilidades, demandas, penas, pérdidas, juicios, pleitos y los costos incidente además, incluyendo costos de defensa, de acuerdo judicial, y de honorarios razonables del abogado, que pueden ser incurridos en, o como resultado de, la muerte o herida personal a cualquier persona, o daños a cualquier característica, propiedad, contaminación de la tierra o efectos ilícitos en esta Facilidad, causado entero o en parte por el cliente, sus empleados, o sus subcontratistas en botar basura en esta Facilidad. En el caso que el Cliente entrega, bota, basura (según lo determinado por Republic) en este Establecimiento basura inaceptable en los reglamentos de este Establecimiento, el Cliente se compromete asumir todos los costos y obligaciones con el retiro y/o la resolución de cualquier dano(s) causado por la entrega de tal basura inaceptable.



NON-HAZARDOUS WASTE MANIFEST

MANIFEST # 11684

GENERATOR INFORMATION

Generator Name: Tronox LLC

Address: P.O. Box 55

City: Henderson County: Clark

State: NV Zip: 89009

Site Location (if different): 560 W. Lake Mead

Henderson, NV 89015 (702) 592-7727

CUSTOMER/BILLING INFORMATION

Billing Name: NGE LLC c/o Northgate Environment Management

Address: 300 Frank Ogawa Plaza, Ste 510

City: Oakland County: Alameda

State: CA Zip: 94612

Table with 5 columns: Republic Services Approval #, Description of Waste, Volume/Weight, Expiration Date, Container Type. Row 1: 38251011244, Soil for disposal, 34.15 TON, 12-31-2011, Tractor with Dump Trailer(s).

*Attach Additional Sheet if necessary

I hereby certify that the above-described materials are non-hazardous wastes as defined by 40 CFR 261 or any applicable state law. Further, that the above named materials are properly classified, described, packaged, marked and labeled, and are in proper condition for transportation according to the applicable regulations of the Department of Transportation.

Susan Crowley (Signature) Generator/Authorized Agent Name Signature Date Shipped

TRANSPORTER INFORMATION

Transporter Name: Las Vegas Paving

DOT # 191949

Address: 4420 S. Decatur

Truck Number: 192457

Las Vegas, NV 89103

Phone Number: (702) 353-4355

I certify no hazardous waste or other regulated substance was knowingly introduced to the waste while in my custody. The waste transported in this vehicle is the waste identified above, to the best of my knowledge.

Brian Brinkhoff (Signature) Name of Authorized Agent Signature Date Delivered 9-30-10

DISPOSAL SITE INFORMATION

Site Name: Apex Regional Landfill

Phone No. (702) 599-5920

Address: 13550 U.S. Hwy 93 Las Vegas, NV

I hereby acknowledge receipt of the above described materials (Signature) Name (Print or Type) Signature Date Received 10-1-10

81 Environmental Tech
13550 N Highway 93
Las Vegas, NV 89165

Ticket Type: INBOUND INVOICE

Ticket Number: 1557
Date: 10/01/2010
Time In: 3:55 am
Time Out: 4:24 am

Customer: 001011 - NGE, LLC c/o Northgate Environ Mgmt

Vehicle/Container: 192460
Contract: Northgate Env. On Site Soils 3825 1
Comment: 3825 10 11244

Gross Weight: 125,920 LB Manual In
Tare Weight: 53,040 LB Manual Out
Net Weight: 72880 LB
Net Tons: 36.44

BOL: 11665

Origin	Yards	Material	Billing	Quantity
Not Applicable	0.00 YD	SW CONTAMINATED SOIL	36.44 TN	

Driver:

Weighmaster

SMITHJ

Indemnification. Customer agrees, by signature above, to indemnify, hold harmless, and defend Republic Services, Inc., its subsidiaries, affiliates, employees, officers and directors from and against any and all liabilities, claims, penalties, forfeitures, suits and the costs and expenses incident thereto, including costs of defense, settlement, and reasonable attorney's fees, which may be incurred, as a result of death or injuries to any person, or damage to any property, contamination of or adverse effects on the environment, caused in whole or in part by the Customer, its employees, or subcontractors in disposing waste at this Facility. In the event Customer delivers Unacceptable Waste (as determined by Republic) Customer agrees to assume all expenses and obligations with the removal and/or resolution of any effects caused by the delivery of such Unacceptable Waste.

Indemnización. Cliente acuerda indemnizar, mantener inmune, y defender Republic Services, Inc., sus subsidiarios, compañías, divisiones, empleados, oficiales y directores contra de cualquiera y de todas responsabilidades, demandas, penas, pérdidas, juicios, pleitos y los costos incidente además, incluyendo costos de defensa, de acuerdo judicial, y de honorarios razonables del abogado, que pueden ser incurridos en, o como resultado de, la muerte o herida personal a cualquier persona, o daños a cualquier característica, propiedad, contaminación de la tierra o efectos ilícitos en esta Facilidad, causado entero o en parte por el cliente, sus empleados, o sus subcontratistas en botar basura en esta Facilidad. En el caso que el Cliente entrega, bota, basura (según lo determinado por Republic) en este Establecimiento basura inaceptable en los reglamentos de este Establecimiento, el Cliente se compromete asumir todos los costos y obligaciones con el retiro y/o la resolución de cualquier dano(s) causado por la entrega de tal basura inaceptable.



NON-HAZARDOUS WASTE MANIFEST

MANIFEST # 11665

GENERATOR INFORMATION

Generator Name: Tronox LLC

Address: P.O. Box 55

City: Henderson County: Clark

State: NV Zip: 89009

Site Location (if different): 560 W. Lake Mead

Henderson, NV 89015 (702) 592-7727

CUSTOMER/BILLING INFORMATION

Billing Name: NGE LLC c/o Northgate Environment Management

Address: 300 Frank Ogawa Plaza, Ste 510

City: Oakland County: Alameda

State: CA Zip: 94612

Republic Services Approval #	Description of Waste	Volume/Weight	Expiration Date	Container Type
38251011244	Soil for disposal		12-31-2011	Tractor with Dump Trailer(s)
	RZ- #	36.4470		

*Attach Additional Sheet if necessary

I hereby certify that the above-described materials are non-hazardous wastes as defined by 40 CFR 261 or any applicable state law. Further, that the above named materials are properly classified, described, packaged, marked and labeled, and are in proper condition for transportation according to the applicable regulations of the Department of Transportation.

Susan Crowley
Generator/Authorized Agent Name

Susan Crowley
Signature

Date Shipped

TRANSPORTER INFORMATION

Transporter Name: Las Vegas Paving

DOT # 191949

Address: 4420 S. Decatur

Truck Number: 2460

Las Vegas, NV 89103

Phone Number: (702) 353-4355

I certify no hazardous waste or other regulated substance was knowingly introduced to the waste while in my custody. The waste transported in this vehicle is the waste identified above, to the best of my knowledge.

Greig Honish
Name of Authorized Agent

Greig Honish
Signature

9-30-10
Date Delivered

DISPOSAL SITE INFORMATION

Site Name: Apex Regional Landfill

Phone No. (702) 599-5920

Address: 13550 U.S. Hwy 93 Las Vegas, NV

I hereby acknowledge receipt of the above described materials

Jesse Smith
Name (Print or Type)

Jesse Smith
Signature

10-1-10
Date Received

81 Environmental Tech
13550 N Highway 93
Las Vegas, NV 89165

Ticket Type: INBOUND INVOICE

Ticket Number: 1558
Date: 10/01/2010
Time In: 3:54 am
Time Out: 4:27 am

Customer: 001011 - NGE, LLC c/o Northgate Environ Mgmt

Vehicle/Container: 44564A
Contract: Northgate Env. On Site Soils 3825 11
Comment: 3825 10 11244

Gross Weight: 120,780 LB Manual In
Tare Weight: 49,020 LB Manual Out
Net Weight: 71760 LB
Net Tons: 35.88

BOL: 11662

Origin	Yards	Material	Billing	Quantity
Not Applicable	0.00 YD	SW CONTAMINATED SOIL	35.88	TN

Driver: _____



Weighmaster: _____

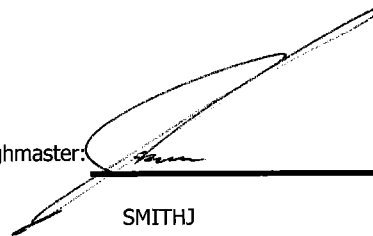

SMITHJ

Indemnification. Customer agrees, by signature above, to indemnify, hold harmless, and defend Republic Services, Inc., its subsidiaries, affiliates, employees, officers and directors from and against any and all liabilities, claims, penalties, forfeitures, suits and the costs and expenses incident thereto, including costs of defense, settlement, and reasonable attorney's fees, which may be incurred, as a result of death or injuries to any person, or damage to any property, contamination of or adverse effects on the environment, caused in whole or in part by the Customer, its employees, or subcontractors in disposing waste at this Facility. In the event Customer delivers Unacceptable Waste (as determined by Republic) Customer agrees to assume all expenses and obligations with the removal and/or resolution of any effects caused by the delivery of such Unacceptable Waste.

Indemnización. Cliente acuerda indemnizar, mantener inmune, y defender Republic Services, Inc., sus subsidiarios, companias, divisiones, empleados, oficiales y directores contra de cualquiera y de todas responsabilidades, demandas, penas, pérdidas, juicios, pleitos y los costos incidente además, incluyendo costos de defensa, de acuerdo judicial, y de honorarios razonables del abogado, que pueden ser incurridos en, o como resultado de, la muerte o herida personal a cualquier persona, o daños a cualquier característica, propiedad, contaminación de la tierra o efectos ilicitos en esta Facilidad, causado entero o en parte por el cliente, sus empleados, o sus subcontratistas en botar basura en esta Facilidad. En el caso que el Cliente entrega, bota, basura (según lo determinado por Republic) en este Establecimiento basura inaceptable en los reglamentos de este Establecimiento, el Cliente se compromete asumir todos los costos y obligaciones con el retiro y/o la resolución de cualquier dano(s) causado por la entrega de tal basura inaceptable.



NON-HAZARDOUS WASTE MANIFEST

MANIFEST # 11682

GENERATOR INFORMATION

Generator Name: Tronox LLC
Address: P.O. Box 55
City: Henderson County: Clark
State: NV Zip: 89009
Site Location (if different): 560 W. Lake Mead
Henderson, NV 89015 (702) 592-7727

CUSTOMER/BILLING INFORMATION

Billing Name: NGE LLC c/o Northgate Environment Management
Address: 300 Frank Ogawa Plaza, Ste 510
City: Oakland County: Alameda
State: CA Zip: 94612

Table with 5 columns: Republic Services Approval #, Description of Waste, Volume/Weight, Expiration Date, Container Type. Row 1: 38251011244, Soil for disposal, 35.88 TN, 12-31-2011, Tractor with Dump Trailer(s).

*Attach Additional Sheet if necessary

I hereby certify that the above-described materials are non-hazardous wastes as defined by 40 CFR 261 or any applicable state law. Further, that the above named materials are properly classified, described, packaged, marked and labeled, and are in proper condition for transportation according to the applicable regulations of the Department of Transportation.

Susan Crowley
Generator/Authorized Agent Name Signature Date Shipped

TRANSPORTER INFORMATION

Transporter Name: Las Vegas Paving DOT # 191949
Address: 4420 S. Decatur Truck Number: 1003
Las Vegas, NV 89103 Phone Number: (702) 353-4355

I certify no hazardous waste or other regulated substance was knowingly introduced to the waste while in my custody. The waste transported in this vehicle is the waste identified above, to the best of my knowledge.

Aseccion
Name of Authorized Agent Signature Date Delivered 9/30/10

DISPOSAL SITE INFORMATION

Site Name: Apex Regional Landfill Phone No. (702) 599-5920
Address: 13550 U.S. Hwy 93 Las Vegas, NV

I hereby acknowledge receipt of the above described materials
Name (Print or Type) Signature Date Received 10-1-10

81 Environmental Tech
13550 N Highway 93
Las Vegas, NV 89165

Ticket Type: INBOUND INVOICE

Ticket Number: 1559
Date: 10/01/2010
Time In: 4:14 am
Time Out: 4:44 am

Customer: 001011 - NGE, LLC c/o Northgate Environ Mgmt

Vehicle/Container: 44161A
Contract: Northgate Env. On Site Soils 3825 11
Comment: 3825 10 11244

Gross Weight: 125,980 LB Manual In
Tare Weight: 52,700 LB Manual Out
Net Weight: 73280 LB
Net Tons: 36.64

BOL: 11666

Origin	Yards	Material	Billing	Quantity
Not Applicable	0.00 YD	SW CONTAMINATED SOIL	36.64	TN

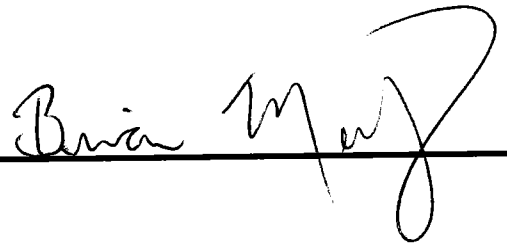
Driver: 

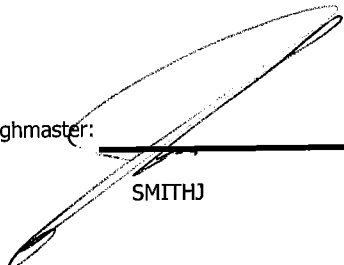
Weighmaster: 
SMITHJ

Indemnification. Customer agrees, by signature above, to indemnify, hold harmless, and defend Republic Services, Inc., its subsidiaries, affiliates, employees, officers and directors from and against any and all liabilities, claims, penalties, forfeitures, suits and the costs and expenses incident thereto, including costs of defense, settlement, and reasonable attorney's fees, which may be incurred, as a result of death or injuries to any person, or damage to any property, contamination of or adverse effects on the environment, caused in whole or in part by the Customer, its employees, or subcontractors in disposing waste at this Facility. In the event Customer delivers Unacceptable Waste (as determined by Republic) Customer agrees to assume all expenses and obligations with the removal and/or resolution of any effects caused by the delivery of such Unacceptable Waste.

Indemnización. Cliente acuerda indemnizar, mantener inmune, y defender Republic Services, Inc., sus subsidiarios, compañías, divisiones, empleados, oficiales y directores contra de cualquiera y de todas responsabilidades, demandas, penas, pérdidas, juicios, pleitos y los costos incidente además, incluyendo costos de defensa, de acuerdo judicial, y de honorarios razonables del abogado, que pueden ser incurridos en, o como resultado de, la muerte o herida personal a cualquier persona, o daños a cualquier característica, propiedad, contaminación de la tierra o efectos ilícitos en esta Facilidad. En el caso que el Cliente entrega, bota, basura (según lo determinado por Republic) en este Establecimiento basura inaceptable en los reglamentos de este Establecimiento, el Cliente se compromete asumir todos los costos y obligaciones con el retiro y/o la resolución de cualquier dano(s) causado por la entrega de tal basura inaceptable.



NON-HAZARDOUS WASTE MANIFEST

MANIFEST # 11666

GENERATOR INFORMATION

Generator Name: Tronox LLC

Address: P.O. Box 55

City: Henderson County: Clark

State: NV Zip: 89009

Site Location (if different): 560 W. Lake Mead

Henderson, NV 89015 (702) 592-7727

CUSTOMER/BILLING INFORMATION

Billing Name: NGE LLC c/o Northgate Environment Management

Address: 300 Frank Ogawa Plaza, Ste 510

City: Oakland County: Alameda

State: CA Zip: 94612

Table with 5 columns: Republic Services Approval #, Description of Waste, Volume/Weight, Expiration Date, Container Type. Row 1: 38251011244, Soil for disposal, 36.64, 12-31-2011, Tractor with Dump Trailer(s).

*Attach Additional Sheet if necessary

I hereby certify that the above-described materials are non-hazardous wastes as defined by 40 CFR 261 or any applicable state law. Further, that the above named materials are properly classified, described, packaged, marked and labeled, and are in proper condition for transportation according to the applicable regulations of the Department of Transportation.

Susan Crowley (Signature) Generator/Authorized Agent Name Signature Date Shipped

TRANSPORTER INFORMATION

Transporter Name: Las Vegas Paving

DOT # 191949

Address: 4420 S. Decatur

Truck Number: K-005

Las Vegas, NV 89103

Phone Number: (702) 353-4355

I certify no hazardous waste or other regulated substance was knowingly introduced to the waste while in my custody. The waste transported in this vehicle is the waste identified above, to the best of my knowledge.

Brian Malvey (Signature) Name of Authorized Agent Signature Date Delivered

DISPOSAL SITE INFORMATION

Site Name: Apex Regional Landfill

Phone No. (702) 599-5920

Address: 13550 U.S. Hwy 93 Las Vegas, NV

I hereby acknowledge receipt of the above described materials

Jose Smith (Signature) Name (Print or Type) Signature Date Received

81 Environmental Tech
13550 N Highway 93
Las Vegas, NV 89165

Ticket Type: INBOUND INVOICE

Ticket Number: 1560
Date: 10/01/2010
Time In: 4:29 am
Time Out: 4:59 am

Customer: 001011 - NGE, LLC c/o Northgate Environ Mgmt

Vehicle/Container: 85430P
Contract: Northgate Env. On Site Soils 3825 11
Comment: 3825 10 11244

Gross Weight: 125,460 LB Manual In
Tare Weight: 53,780 LB Manual Out
Net Weight: 71680 LB
Net Tons: 35.84

BOL: 11667

Origin	Yards	Material	Billing	Quantity
Not Applicable	0.00 YD	SW CONTAMINATED SOIL	35.84	TN

Driver:

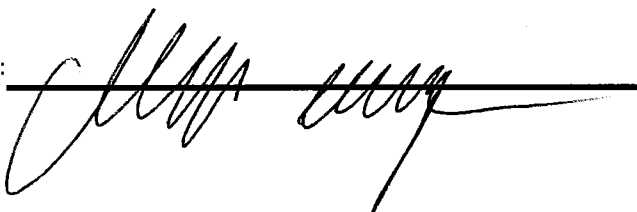

Weighmaster:

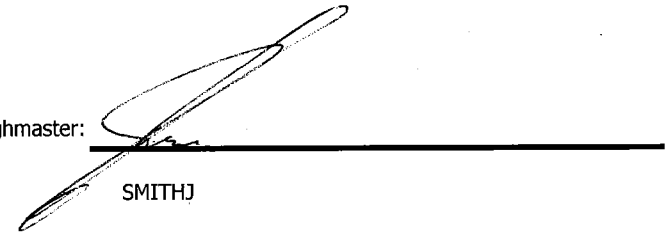

SMITHJ

Indemnification. Customer agrees, by signature above, to indemnify, hold harmless, and defend Republic Services, Inc., its subsidiaries, affiliates, employees, officers and directors from and against any and all liabilities, claims, penalties, forfeitures, suits and the costs and expenses incident thereto, including costs of defense, settlement, and reasonable attorney's fees, which may be incurred, as a result of death or injuries to any person, or damage to any property, contamination of or adverse effects on the environment, caused in whole or in part by the Customer, its employees, or subcontractors in disposing waste at this Facility. In the event Customer delivers Unacceptable Waste (as determined by Republic) Customer agrees to assume all expenses and obligations with the removal and/or resolution of any effects caused by the delivery of such Unacceptable Waste.

Indemnización. Cliente acuerda indemnizar, mantener inmune, y defender Republic Services, Inc., sus subsidiarios, companias, divisiones, empleados, oficiales y directores contra de cualquiera y de todas responsabilidades, demandas, penas, pérdidas, juicios, pleitos y los costos incidente además, incluyendo costos de defensa, de acuerdo judicial, y de honorarios razonables del abogado, que pueden ser incurridos en, o como resultado de, la muerte o herida personal a cualquier persona, o daños a cualquier característica, propiedad, contaminación de la tierra o efectos ilicitos en esta Facilidat, causado entero o en parte por el cliente, sus empleados, o sus subcontratistas en botar basura en esta Facilidat. En el caso que el Cliente entrega, bota, basura (según lo determinado por Republic) en este Establecimiento basura inaceptable en los reglamentos de este Establecimiento, el Cliente se compromete asumir todos los costos y obligaciones con el retiro y/o la resolución de cualquier dano(s) causado por la entrega de tal basura inaceptable.



NON-HAZARDOUS WASTE MANIFEST

MANIFEST # 11667

GENERATOR INFORMATION

Generator Name: Tronox LLC

Address: P.O. Box 55

City: Henderson County: Clark

State: NV Zip: 89009

Site Location (if different): 560 W. Lake Mead

Henderson, NV 89015 (702) 592-7727

CUSTOMER/BILLING INFORMATION

Billing Name: NGE LLC c/o Northgate Environment Management

Address: 300 Frank Ogawa Plaza, Ste 510

City: Oakland County: Alameda

State: CA Zip: 94612

Republic Services Approval #	Description of Waste	Volume/Weight	Expiration Date	Container Type
38251011244	Soil for disposal		12-31-2011	Tractor with Dump Trailer(s)
	RZ-_____#_____	35.84 70		

*Attach Additional Sheet if necessary

I hereby certify that the above-described materials are non-hazardous wastes as defined by 40 CFR 261 or any applicable state law. Further, that the above named materials are properly classified, described, packaged, marked and labeled, and are in proper condition for transportation according to the applicable regulations of the Department of Transportation.

Susan Crowley
Generator/Authorized Agent Name
Signature
Date Shipped

TRANSPORTER INFORMATION

Transporter Name: Las Vegas Paving

DOT # 191949

Address: 4420 S. Decatur

Truck Number: 87

Las Vegas, NV 89103

Phone Number: (702) 353-4355

I certify no hazardous waste or other regulated substance was knowingly introduced to the waste while in my custody. The waste transported in this vehicle is the waste identified above, to the best of my knowledge.

MERI SOSA
Name of Authorized Agent
Signature
Date Delivered 9/30/10

DISPOSAL SITE INFORMATION

Site Name: Apex Regional Landfill

Phone No. (702) 599-5920

Address: 13550 U.S. Hwy 93 Las Vegas, NV

I hereby acknowledge receipt of the above described materials

Name (Print or Type) Signature Date Received

81 Environmental Tech
13550 N Highway 93
Las Vegas, NV 89165

Ticket Type: INBOUND INVOICE

Ticket Number: 1562
Date: 10/01/2010
Time In: 7:07 am
Time Out: 7:32 am

Customer: 001011 - NGE, LLC c/o Northgate Environ Mgmt

Vehicle/Container: 192358
Contract: Northgate Env. On Site Soils 3825 11
Comment: 3825-10-11244

Gross Weight: 87,300 LB Scale In
Tare Weight: 38,380 LB Scale Out
Net Weight: 48920 LB
Net Tons: 24.46

BOL: 11668

Origin	Yards	Material	Billing	Quantity
Not Applicable	0.00 YD	SW CONTAMINATED SOIL	24.46	TN

Driver: 

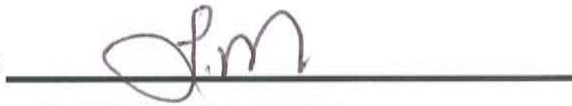
Weighmaster: 

IN - JORDADE OUT - MORENOJ

Indemnification. Customer agrees, by signature above, to indemnify, hold harmless, and defend Republic Services, Inc., its subsidiaries, affiliates, employees, officers and directors from and against any and all liabilities, claims, penalties, forfeitures, suits and the costs and expenses incident thereto, including costs of defense, settlement, and reasonable attorney's fees, which may be incurred, as a result of death or injuries to any person, or damage to any property, contamination of or adverse effects on the environment, caused in whole or in part by the Customer, its employees, or subcontractors in disposing waste at this Facility. In the event Customer delivers Unacceptable Waste (as determined by Republic) Customer agrees to assume all expenses and obligations with the removal and/or resolution of any effects caused by the delivery of such Unacceptable Waste.

Indemnización. Cliente acuerda indemnizar, mantener inmune, y defender Republic Services, Inc., sus subsidiarios, compañías, divisiones, empleados, oficiales y directores contra de cualquiera y de todas responsabilidades, demandas, penas, pérdidas, juicios, pleitos y los costos incidente además, incluyendo costos de defensa, de acuerdo judicial, y de honorarios razonables del abogado, que pueden ser incurridos en, o como resultado de, la muerte o herida personal a cualquier persona, o daños a cualquier característica, propiedad, contaminación de la tierra o efectos ilícitos en esta Facilidad, causado entero o en parte por el cliente, sus empleados, o sus subcontratistas en botar basura en esta Facilidad. En el caso que el Cliente entrega, bota, basura (según lo determinado por Republic) en este Establecimiento basura inaceptable en los reglamentos de este Establecimiento, el Cliente se compromete asumir todos los costos y obligaciones con el retiro y/o la resolución de cualquier dano(s) causado por la entrega de tal basura inaceptable.



NON-HAZARDOUS WASTE MANIFEST

MANIFEST # 11668

GENERATOR INFORMATION

Generator Name: Tronox LLC
Address: P.O. Box 55
City: Henderson County: Clark
State: NV Zip: 89009
Site Location (if different): 560 W. Lake Mead
Henderson, NV 89015 (702) 592-7727

CUSTOMER/BILLING INFORMATION

Billing Name: NGE LLC c/o Northgate Environment Management
Address: 300 Frank Ogawa Plaza, Ste 510
City: Oakland County: Alameda
State: CA Zip: 94612

Table with 5 columns: Republic Services Approval #, Description of Waste, Volume/Weight, Expiration Date, Container Type. Row 1: 38251011244, Soil for disposal, 24.46 TN, 12-31-2011, Tractor with Dump Trailer(s).

*Attach Additional Sheet if necessary

I hereby certify that the above-described materials are non-hazardous wastes as defined by 40 CFR 261 or any applicable state law. Further, that the above named materials are properly classified, described, packaged, marked and labeled, and are in proper condition for transportation according to the applicable regulations of the Department of Transportation.

Susan Crowley
Generator/Authorized Agent Name Signature Date Shipped

TRANSPORTER INFORMATION

Transporter Name: Las Vegas Paving DOT # 191949
Address: 4420 S. Decatur Truck Number:
Las Vegas, NV 89103 Phone Number: (702) 353-4355

I certify no hazardous waste or other regulated substance was knowingly introduced to the waste while in my custody. The waste transported in this vehicle is the waste identified above, to the best of my knowledge.

Name of Authorized Agent Signature Date Delivered 10-1-10

DISPOSAL SITE INFORMATION

Site Name: Apex Regional Landfill Phone No. (702) 599-5920
Address: 13550 U.S. Hwy 93 Las Vegas, NV

I hereby acknowledge receipt of the above described materials
Name (Print or Type) Signature Date Received 10-1-10

81 Environmental Tech
13550 N Highway 93
Las Vegas, NV 89165

Ticket Type: INBOUND INVOICE

Ticket Number: 1563
Date: 10/01/2010
Time In: 7:09 am
Time Out: 7:32 am

Customer: 001011 - NGE, LLC c/o Northgate Environ Mgmt

Vehicle/Container: 192391
Contract: Northgate Env. On Site Soils 3825 11
Comment: 3825-10-11244

Gross Weight: 84,900 LB Scale In
Tare Weight: 39,080 LB Manual Out
Net Weight: 45820 LB
Net Tons: 22.91

BOL: 11669

Origin	Yards	Material	Billing	Quantity
Not Applicable	0.00 YD	SW CONTAMINATED SOIL	22.91	TN

Driver: _____

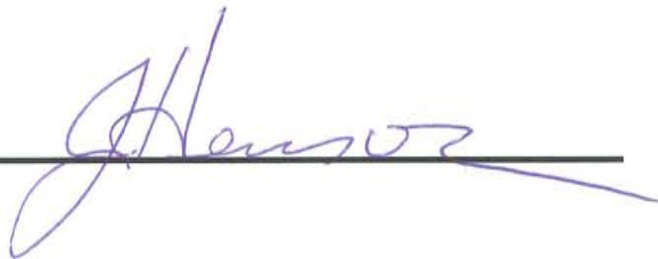

Weighmaster: _____



IN - JORDADE OUT - MORENOJ

Indemnification. Customer agrees, by signature above, to indemnify, hold harmless, and defend Republic Services, Inc., its subsidiaries, affiliates, employees, officers and directors from and against any and all liabilities, claims, penalties, forfeitures, suits and the costs and expenses incident thereto, including costs of defense, settlement, and reasonable attorney's fees, which may be incurred, as a result of death or injuries to any person, or damage to any property, contamination of or adverse effects on the environment, caused in whole or in part by the Customer, its employees, or subcontractors in disposing waste at this Facility. In the event Customer delivers Unacceptable Waste (as determined by Republic) Customer agrees to assume all expenses and obligations with the removal and/or resolution of any effects caused by the delivery of such Unacceptable Waste.

Indemnización. Cliente acuerda indemnizar, mantener inmune, y defender Republic Services, Inc., sus subsidiarios, compañías, divisiones, empleados, oficiales y directores contra de cualquiera y de todas responsabilidades, demandas, penas, pérdidas, juicios, pleitos y los costos incidente además, incluyendo costos de defensa, de acuerdo judicial, y de honorarios razonables del abogado, que pueden ser incurridos en, o como resultado de, la muerte o herida personal a cualquier persona, o daños a cualquier característica, propiedad, contaminación de la tierra o efectos ilícitos en esta Facilidad, causado entero o en parte por el cliente, sus empleados, o sus subcontratistas en botar basura en esta Facilidad. En el caso que el Cliente entrega, bota, basura (según lo determinado por Republic) en este Establecimiento basura inaceptable en los reglamentos de este Establecimiento, el Cliente se compromete asumir todos los costos y obligaciones con el retiro y/o la resolución de cualquier dano(s) causado por la entrega de tal basura inaceptable.



NON-HAZARDOUS WASTE MANIFEST

MANIFEST # 11669

GENERATOR INFORMATION

Generator Name: Tronox LLC
Address: P.O. Box 55
City: Henderson County: Clark
State: NV Zip: 89009
Site Location (if different): 560 W. Lake Mead
Henderson, NV 89015 (702) 592-7727

CUSTOMER/BILLING INFORMATION

Billing Name: NGE LLC c/o Northgate Environment Management
Address: 300 Frank Ogawa Plaza, Ste 510
City: Oakland County: Alameda
State: CA Zip: 94612

Table with 5 columns: Republic Services Approval #, Description of Waste, Volume/Weight, Expiration Date, Container Type. Row 1: 38251011244, Soil for disposal, 22-91 TN, 12-31-2011, Tractor with Dump Trailer(s).

*Attach Additional Sheet if necessary

I hereby certify that the above-described materials are non-hazardous wastes as defined by 40 CFR 261 or any applicable state law. Further, that the above named materials are properly classified, described, packaged, marked and labeled, and are in proper condition for transportation according to the applicable regulations of the Department of Transportation.

Susan Crowley
Generator/Authorized Agent Name Signature Date Shipped

TRANSPORTER INFORMATION

Transporter Name: Las Vegas Paving DOT # 191949
Address: 4420 S. Decatur Truck Number:
Las Vegas, NV 89103 Phone Number: (702) 353-4355

I certify no hazardous waste or other regulated substance was knowingly introduced to the waste while in my custody. The waste transported in this vehicle is the waste identified above, to the best of my knowledge.

Name of Authorized Agent Signature Date Delivered

DISPOSAL SITE INFORMATION

Site Name: Apex Regional Landfill Phone No. (702) 599-5920
Address: 13550 U.S. Hwy 93 Las Vegas, NV

I hereby acknowledge receipt of the above described materials
Juan Moreno Signature Date Received 10-1-10

81 Environmental Tech
13550 N Highway 93
Las Vegas, NV 89165

Ticket Type: INBOUND INVOICE

Ticket Number: 1565
Date: 10/01/2010
Time In: 9:20 am
Time Out: 9:46 am

Customer: 001011 - NGE, LLC c/o Northgate Environ Mgmt

Vehicle/Container: 192358
Contract: Northgate Env. On Site Soils 3825 11
Comment: 3825-10-11244

Gross Weight: 87,380 LB Scale In
Tare Weight: 38,140 LB Scale Out
Net Weight: 49240 LB
Net Tons: 24.62

BOL: 11670

Origin	Yards	Material	Billing	Quantity
Not Applicable	0.00 YD	SW CONTAMINATED SOIL	24.62	TN

Driver:



Weighmaster:



IN - JORDADE OUT - MORENOJ

Indemnification. Customer agrees, by signature above, to indemnify, hold harmless, and defend Republic Services, Inc., its subsidiaries, affiliates, employees, officers and directors from and against any and all liabilities, claims, penalties, forfeitures, suits and the costs and expenses incident thereto, including costs of defense, settlement, and reasonable attorney's fees, which may be incurred, as a result of death or injuries to any person, or damage to any property, contamination of or adverse effects on the environment, caused in whole or in part by the Customer, its employees, or subcontractors in disposing waste at this Facility. In the event Customer delivers Unacceptable Waste (as determined by Republic) Customer agrees to assume all expenses and obligations with the removal and/or resolution of any effects caused by the delivery of such Unacceptable Waste.

Indemnización. Cliente acuerda indemnizar, mantener inmune, y defender Republic Services, Inc., sus subsidiarios, companias, divisiones, empleados, oficiales y directores contra de cualquiera y de todas responsabilidades, demandas, penas, pérdidas, juicios, pleitos y los costos incidente además, incluyendo costos de defensa, de acuerdo judicial, y de honorarios razonables del abogado, que pueden ser incurridos en, o como resultado de, la muerte o herida personal a cualquier persona, o daños a cualquier característica, propiedad, contaminación de la tierra o efectos ilicitos en esta Facilidad, causado entero o en parte por el cliente, sus empleados, o sus subcontratistas en botar basura en esta Facilidad. En el caso que el Cliente entrega, bota, basura (según lo determinado por Republic) en este Establecimiento basura inaceptable en los reglamentos de este Establecimiento, el Cliente se compromete asumir todos los costos y obligaciones con el retiro y/o la resolución de cualquier dano(s) causado por la entrega de tal basura inaceptable.



NON-HAZARDOUS WASTE MANIFEST

MANIFEST # 11670

GENERATOR INFORMATION

Generator Name: Tronox LLC
Address: P.O. Box 55
City: Henderson County: Clark
State: NV Zip: 89009
Site Location (if different): 560 W. Lake Mead
Henderson, NV 89015 (702) 592-7727

CUSTOMER/BILLING INFORMATION

Billing Name: NGE LLC c/o Northgate Environment Management
Address: 300 Frank Ogawa Plaza, Ste 510
City: Oakland County: Alameda
State: CA Zip: 94612

Table with 5 columns: Republic Services Approval #, Description of Waste, Volume/Weight, Expiration Date, Container Type. Row 1: 38251011244, Soil for disposal, 24.62, 12-31-2011, Tractor with Dump Trailer(s).

*Attach Additional Sheet if necessary

I hereby certify that the above-described materials are non-hazardous wastes as defined by 40 CFR 261 or any applicable state law. Further, that the above named materials are properly classified, described, packaged, marked and labeled, and are in proper condition for transportation according to the applicable regulations of the Department of Transportation.

Susan Crowley
Generator/Authorized Agent Name Signature Date Shipped

TRANSPORTER INFORMATION

Transporter Name: Las Vegas Paving DOT # 191949
Address: 4420 S. Decatur Truck Number:
Las Vegas, NV 89103 Phone Number: (702) 353-4355

I certify no hazardous waste or other regulated substance was knowingly introduced to the waste while in my custody. The waste transported in this vehicle is the waste identified above, to the best of my knowledge.

Name of Authorized Agent Signature Date Delivered

DISPOSAL SITE INFORMATION

Site Name: Apex Regional Landfill Phone No. (702) 599-5920
Address: 13550 U.S. Hwy 93 Las Vegas, NV

I hereby acknowledge receipt of the above described materials
Name (Print or Type) Signature Date Received

81 Environmental Tech
13550 N Highway 93
Las Vegas, NV 89165

Ticket Type: INBOUND INVOICE

Ticket Number: 1566
Date: 10/01/2010
Time In: 9:21 am
Time Out: 9:48 am

Customer: 001011 - NGE, LLC c/o Northgate Environ Mgmt

Vehicle/Container: 192391
Contract: Northgate Env. On Site Soils 3825 11
Comment: 3825-1011244

Gross Weight: 89,940 LB Scale In
Tare Weight: 38,980 LB Manual Out
Net Weight: 50960 LB
Net Tons: 25.48

BOL: 11971

Origin	Yards	Material	Billing	Quantity
Not Applicable	0.00 YD	SW CONTAMINATED SOIL	25.48	TN

Driver: 

Weighmaster: 05

IN - JORDADE OUT - MORENOJ

Indemnification. Customer agrees, by signature above, to indemnify, hold harmless, and defend Republic Services, Inc., its subsidiaries, affiliates, employees, officers and directors from and against any and all liabilities, claims, penalties, forfeitures, suits and the costs and expenses incident thereto, including costs of defense, settlement, and reasonable attorney's fees, which may be incurred, as a result of death or injuries to any person, or damage to any property, contamination of or adverse effects on the environment, caused in whole or in part by the Customer, its employees, or subcontractors in disposing waste at this Facility. In the event Customer delivers Unacceptable Waste (as determined by Republic) Customer agrees to assume all expenses and obligations with the removal and/or resolution of any effects caused by the delivery of such Unacceptable Waste.

Indemnización. Cliente acuerda indemnizar, mantener inmune, y defender Republic Services, Inc., sus subsidiarios, compañías, divisiones, empleados, oficiales y directores contra de cualquiera y de todas responsabilidades, demandas, penas, pérdidas, juicios, pleitos y los costos incidente además, incluyendo costos de defensa, de acuerdo judicial, y de honorarios razonables del abogado, que pueden ser incurridos en, o como resultado de, la muerte o herida personal a cualquier persona, o daños a cualquier característica, propiedad, contaminación de la tierra o efectos ilícitos en esta Facilidad, causado entero o en parte por el cliente, sus empleados, o sus subcontratistas en botar basura en esta Facilidad. En el caso que el Cliente entrega, bota, basura (según lo determinado por Republic) en este Establecimiento basura inaceptable en los reglamentos de este Establecimiento, el Cliente se compromete asumir todos los costos y obligaciones con el retiro y/o la resolución de cualquier dano(s) causado por la entrega de tal basura inaceptable.



NON-HAZARDOUS WASTE MANIFEST

MANIFEST # 11671

GENERATOR INFORMATION

Generator Name: Tronox LLC
Address: P.O. Box 55
City: Henderson County: Clark
State: NV Zip: 89009
Site Location (if different): 560 W. Lake Mead
Henderson, NV 89015 (702) 592-7727

CUSTOMER/BILLING INFORMATION

Billing Name: NGE LLC c/o Northgate Environment Management
Address: 300 Frank Ogawa Plaza, Ste 510
City: Oakland County: Alameda
State: CA Zip: 94612

Table with 5 columns: Republic Services Approval #, Description of Waste, Volume/Weight, Expiration Date, Container Type. Row 1: 38251011244, Soil for disposal, 25.48, 12-31-2011, Tractor with Dump Trailer(s).

*Attach Additional Sheet if necessary

I hereby certify that the above-described materials are non-hazardous wastes as defined by 40 CFR 261 or any applicable state law. Further, that the above named materials are properly classified, described, packaged, marked and labeled, and are in proper condition for transportation according to the applicable regulations of the Department of Transportation.

Susan Crowley
Generator/Authorized Agent Name Signature Date Shipped

TRANSPORTER INFORMATION

Transporter Name: Las Vegas Paving DOT # 191949
Address: 4420 S. Decatur Truck Number:
Las Vegas, NV 89103 Phone Number: (702) 353-4355

I certify no hazardous waste or other regulated substance was knowingly introduced to the waste while in my custody. The waste transported in this vehicle is the waste identified above, to the best of my knowledge.

Name of Authorized Agent Signature Date Delivered
10-01-10 10/1/10

DISPOSAL SITE INFORMATION

Site Name: Apex Regional Landfill Phone No. (702) 599-5920
Address: 13550 U.S. Hwy 93 Las Vegas, NV

I hereby acknowledge receipt of the above described materials
Name (Print or Type) Signature Date Received
10-1-10

81 Environmental Tech
13550 N Highway 93
Las Vegas, NV 89165

Ticket Type: INBOUND INVOICE

Ticket Number: 1568
Date: 10/01/2010
Time In: 11:32 am
Time Out: 11:53 am

Customer: 001011 - NGE, LLC c/o Northgate Environ Mgmt

Vehicle/Container: 192358
Contract: Northgate Env. On Site Soils 3825 11
Comment: 3825-10-11244

Gross Weight: 85,740 LB Scale In
Tare Weight: 38,020 LB Manual Out
Net Weight: 47720 LB
Net Tons: 23.86

BOL: 11672

Origin	Yards	Material	Billing	Quantity
Not Applicable	0.00 YD	SW CONTAMINATED SOIL	23.86	TN

Driver: _____

Weighmaster: _____

IN - JORDADE OUT - GUILFDE

Indemnification. Customer agrees, by signature above, to indemnify, hold harmless, and defend Republic Services, Inc., its subsidiaries, affiliates, employees, officers and directors from and against any and all liabilities, claims, penalties, forfeitures, suits and the costs and expenses incident thereto, including costs of defense, settlement, and reasonable attorney's fees, which may be incurred, as a result of death or injuries to any person, or damage to any property, contamination of or adverse effects on the environment, caused in whole or in part by the Customer, its employees, or subcontractors in disposing waste at this Facility. In the event Customer delivers Unacceptable Waste (as determined by Republic) Customer agrees to assume all expenses and obligations with the removal and/or resolution of any effects caused by the delivery of such Unacceptable Waste.

Indemnización. Cliente acuerda indemnizar, mantener inmune, y defender Republic Services, Inc., sus subsidiarios, compañías, divisiones, empleados, oficiales y directores contra de cualquiera y de todas responsabilidades, demandas, penas, pérdidas, juicios, pleitos y los costos incidente además, incluyendo costos de defensa, de acuerdo judicial, y de honorarios razonables del abogado, que pueden ser incurridos en, o como resultado de, la muerte o herida personal a cualquier persona, o daños a cualquier característica, propiedad, contaminación de la tierra o efectos ilícitos en esta Facilidad, causado entero o en parte por el cliente, sus empleados, o sus subcontratistas en botar basura en esta Facilidad. En el caso que el Cliente entrega, bota, basura (según lo determinado por Republic) en este Establecimiento basura inaceptable en los reglamentos de este Establecimiento, el Cliente se compromete asumir todos los costos y obligaciones con el retiro y/o la resolución de cualquier dano(s) causado por la entrega de tal basura inaceptable.



NON-HAZARDOUS WASTE MANIFEST

MANIFEST # 11672

GENERATOR INFORMATION

Generator Name: Tronox LLC
Address: P.O. Box 55
City: Henderson County: Clark
State: NV Zip: 89009
Site Location (if different): 560 W. Lake Mead
Henderson, NV 89015 (702) 592-7727

CUSTOMER/BILLING INFORMATION

Billing Name: NGE LLC c/o Northgate Environment Management
Address: 300 Frank Ogawa Plaza, Ste 510
City: Oakland County: Alameda
State: CA Zip: 94612

Table with 5 columns: Republic Services Approval #, Description of Waste, Volume/Weight, Expiration Date, Container Type. Row 1: 38251011244, Soil for disposal, 23.86, 12-31-2011, Tractor with Dump Trailer(s).

*Attach Additional Sheet if necessary

I hereby certify that the above-described materials are non-hazardous wastes as defined by 40 CFR 261 or any applicable state law. Further, that the above named materials are properly classified, described, packaged, marked and labeled, and are in proper condition for transportation according to the applicable regulations of the Department of Transportation.

Susan Crowley
Generator/Authorized Agent Name Signature Date Shipped

TRANSPORTER INFORMATION

Transporter Name: Las Vegas Paving DOT # 191949
Address: 4420 S. Decatur Truck Number:
Las Vegas, NV 89103 Phone Number: (702) 353-4355

I certify no hazardous waste or other regulated substance was knowingly introduced to the waste while in my custody. The waste transported in this vehicle is the waste identified above, to the best of my knowledge.

Name of Authorized Agent Signature Date Delivered
10-01-10 10/1/10

DISPOSAL SITE INFORMATION

Site Name: Apex Regional Landfill Phone No. (702) 599-5920
Address: 13550 U.S. Hwy 93 Las Vegas, NV

I hereby acknowledge receipt of the above described materials
Debbie Curtoile Signature Date Received 10-1-10

81 Environmental Tech
13550 N Highway 93
Las Vegas, NV 89165

Ticket Type: INBOUND INVOICE

Ticket Number: 1569
Date: 10/01/2010
Time In: 11:34 am
Time Out: 11:54 am

Customer: 001011 - NGE, LLC c/o Northgate Environ Mgmt

Vehicle/Container: 192391
Contract: Northgate Env. On Site Soils 3825 11
Comment: 3825 10 11244

Gross Weight: 90,880 LB Scale In
Tare Weight: 38,820 LB Scale Out
Net Weight: 52060 LB
Net Tons: 26.03

BOL: 11673

Origin	Yards	Material	Billing	Quantity
Not Applicable	0.00 YD	SW CONTAMINATED SOIL	26.03	TN

Driver: _____



Weighmaster: _____

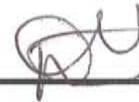

IN - JORDADE OUT - GUILFDE

Indemnification. Customer agrees, by signature above, to indemnify, hold harmless, and defend Republic Services, Inc., its subsidiaries, affiliates, employees, officers and directors from and against any and all liabilities, claims, penalties, forfeitures, suits and the costs and expenses incident thereto, including costs of defense, settlement, and reasonable attorney's fees, which may be incurred, as a result of death or injuries to any person, or damage to any property, contamination of or adverse effects on the environment, caused in whole or in part by the Customer, its employees, or subcontractors in disposing waste at this Facility. In the event Customer delivers Unacceptable Waste (as determined by Republic) Customer agrees to assume all expenses and obligations with the removal and/or resolution of any effects caused by the delivery of such Unacceptable Waste.

Indemnización. Cliente acuerda indemnizar, mantener inmune, y defender Republic Services, Inc., sus subsidiarios, compañías, divisiones, empleados, oficiales y directores contra de cualquiera y de todas responsabilidades, demandas, penas, pérdidas, juicios, pleitos y los costos incidente además, incluyendo costos de defensa, de acuerdo judicial, y de honorarios razonables del abogado, que pueden ser incurridos en, o como resultado de, la muerte o herida personal a cualquier persona, o daños a cualquier característica, propiedad, contaminación de la tierra o efectos ilícitos en esta Facilidad, causado entero o en parte por el cliente, sus empleados, o sus subcontratistas en botar basura en esta Facilidad. En el caso que el Cliente entrega, bota, basura (según lo determinado por Republic) en este Establecimiento basura inaceptable en los reglamentos de este Establecimiento, el Cliente se compromete asumir todos los costos y obligaciones con el retiro y/o la resolución de cualquier dano(s) causado por la entrega de tal basura inaceptable.



NON-HAZARDOUS WASTE MANIFEST

MANIFEST # 11673

GENERATOR INFORMATION

Generator Name: Tronox LLC
Address: P.O. Box 55
City: Henderson County: Clark
State: NV Zip: 89009
Site Location (if different): 560 W. Lake Mead
Henderson, NV 89015 (702) 592-7727

CUSTOMER/BILLING INFORMATION

Billing Name: NGE LLC c/o Northgate Environment Management
Address: 300 Frank Ogawa Plaza, Ste 510
City: Oakland County: Alameda
State: CA Zip: 94612

Table with 5 columns: Republic Services Approval #, Description of Waste, Volume/Weight, Expiration Date, Container Type. Row 1: 38251011244, Soil for disposal, 26.03, 12-31-2011, Tractor with Dump Trailer(s)

*Attach Additional Sheet if necessary

I hereby certify that the above-described materials are non-hazardous wastes as defined by 40 CFR 261 or any applicable state law. Further, that the above named materials are properly classified, described, packaged, marked and labeled, and are in proper condition for transportation according to the applicable regulations of the Department of Transportation.

Susan Crowley
Generator/Authorized Agent Name Signature Date Shipped

TRANSPORTER INFORMATION

Transporter Name: Las Vegas Paving DOT # 191949
Address: 4420 S. Decatur Truck Number:
Las Vegas, NV 89103 Phone Number: (702) 353-4355

I certify no hazardous waste or other regulated substance was knowingly introduced to the waste while in my custody. The waste transported in this vehicle is the waste identified above, to the best of my knowledge.

Name of Authorized Agent Signature Date Delivered

DISPOSAL SITE INFORMATION

Site Name: Apex Regional Landfill Phone No. (702) 599-5920
Address: 13550 U.S. Hwy 93 Las Vegas, NV

I hereby acknowledge receipt of the above described materials
Name (Print or Type) Signature Date Received

81 Environmental Tech
13550 N Highway 93
Las Vegas, NV 89165

Ticket Type: INBOUND INVOICE

Ticket Number: 1572
Date: 10/03/2010
Time In: 7:56 pm
Time Out: 8:21 pm

Customer: 001011 - NGE, LLC c/o Northgate Environ Mgmt

Vehicle/Container: 20915A
Contract: Northgate Env. On Site Soils 3825 11
Comment: 3825 10 11244

Gross Weight: 124,320 LB Manual In
Tare Weight: 53,260 LB Scale Out
Net Weight: 71060 LB
Net Tons: 35.53

BOL: 11674

Origin	Yards	Material	Billing	Quantity
Not Applicable	0.00 YD	SW CONTAMINATED SOIL	35.53	TN

Driver:



Weighmaster:

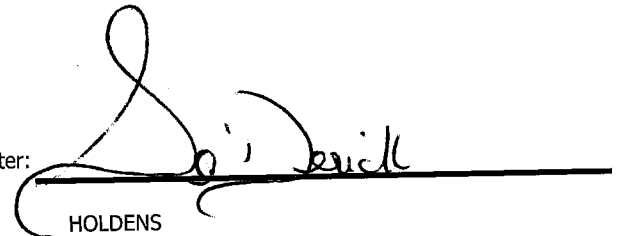

HOLDENS

Indemnification. Customer agrees, by signature above, to indemnify, hold harmless, and defend Republic Services, Inc., its subsidiaries, affiliates, employees, officers and directors from and against any and all liabilities, claims, penalties, forfeitures, suits and the costs and expenses incident thereto, including costs of defense, settlement, and reasonable attorney's fees, which may be incurred, as a result of death or injuries to any person, or damage to any property, contamination of or adverse effects on the environment, caused in whole or in part by the Customer, its employees, or subcontractors in disposing waste at this Facility. In the event Customer delivers Unacceptable Waste (as determined by Republic) Customer agrees to assume all expenses and obligations with the removal and/or resolution of any effects caused by the delivery of such Unacceptable Waste.

Indemnización. Cliente acuerda indemnizar, mantener inmune, y defender Republic Services, Inc., sus subsidiarios, compañías, divisiones, empleados, oficiales y directores contra de cualquiera y de todas responsabilidades, demandas, penas, pérdidas, juicios, pleitos y los costos incidente además, incluyendo costos de defensa, de acuerdo judicial, y de honorarios razonables del abogado, que pueden ser incurridos en, o como resultado de, la muerte o herida personal a cualquier persona, o daños a cualquier característica, propiedad, contaminación de la tierra o efectos ilícitos en esta Facilidad, causado entero o en parte por el cliente, sus empleados, o sus subcontratistas en botar basura en esta Facilidad. En el caso que el Cliente entrega, bota, basura (según lo determinado por Republic) en este Establecimiento basura inaceptable en los reglamentos de este Establecimiento, el Cliente se compromete asumir todos los costos y obligaciones con el retiro y/o la resolución de cualquier dano(s) causado por la entrega de tal basura inaceptable.



NON-HAZARDOUS WASTE MANIFEST

MANIFEST # 11674

GENERATOR INFORMATION

Generator Name: Tronox LLC

Address: P.O. Box 55

City: Henderson County: Clark

State: NV Zip: 89009

Site Location (if different): 560 W. Lake Mead

Henderson, NV 89015 (702) 592-7727

CUSTOMER/BILLING INFORMATION

Billing Name: NGE LLC c/o Northgate Environment Management

Address: 300 Frank Ogawa Plaza, Ste 510

City: Oakland County: Alameda

State: CA Zip: 94612

Republic Services Approval #	Description of Waste	Volume/Weight	Expiration Date	Container Type
38251011244	Soil for disposal	35 ⁵³ / ₁₀₀	12-31-2011	Tractor with Dump Trailer(s)
	RZ- #			

*Attach Additional Sheet if necessary

I hereby certify that the above-described materials are non-hazardous wastes as defined by 40 CFR 261 or any applicable state law. Further, that the above named materials are properly classified, described, packaged, marked and labeled, and are in proper condition for transportation according to the applicable regulations of the Department of Transportation.

Susan Crowley (Signature) Date Shipped

TRANSPORTER INFORMATION

Transporter Name: Las Vegas Paving

DOT # 191949

Address: 4420 S. Decatur

Truck Number: 00

Las Vegas, NV 89103

Phone Number: (702) 353-4355

I certify no hazardous waste or other regulated substance was knowingly introduced to the waste while in my custody. The waste transported in this vehicle is the waste identified above, to the best of my knowledge.

Tom Rawlins (Signature) Thomas Rawlins (Signature) 10-3-10 (Date Delivered)

DISPOSAL SITE INFORMATION

Site Name: Apex Regional Landfill

Phone No. (702) 599-5920

Address: 13550 U.S. Hwy 93 Las Vegas, NV

I hereby acknowledge receipt of the above described materials Holden, Se' Derrick (Signature) 03 Oct 10 (Date Received)

81 Environmental Tech
13550 N Highway 93
Las Vegas, NV 89165

Ticket Type: INBOUND INVOICE

Ticket Number: 1573
Date: 10/03/2010
Time In: 8:00 pm
Time Out: 8:23 pm

Customer: 001011 - NGE, LLC c/o Northgate Environ Mgmt

Vehicle/Container: 81494P
Contract: Northgate Env. On Site Soils 3825 11
Comment: 3825 10 11244

Gross Weight: 121,040 LB Manual In
Tare Weight: 51,080 LB Manual Out
Net Weight: 69960 LB
Net Tons: 34.98

BOL: 11675

Origin	Yards	Material	Billing	Quantity
Not Applicable	0.00 YD	SW CONTAMINATED SOIL	34.98	TN

Driver: _____

Weighmaster: _____

HOLDENS

Indemnification. Customer agrees, by signature above, to indemnify, hold harmless, and defend Republic Services, Inc., its subsidiaries, affiliates, employees, officers and directors from and against any and all liabilities, claims, penalties, forfeitures, suits and the costs and expenses incident thereto, including costs of defense, settlement, and reasonable attorney's fees, which may be incurred, as a result of death or injuries to any person, or damage to any property, contamination of or adverse effects on the environment, caused in whole or in part by the Customer, its employees, or subcontractors in disposing waste at this Facility. In the event Customer delivers Unacceptable Waste (as determined by Republic) Customer agrees to assume all expenses and obligations with the removal and/or resolution of any effects caused by the delivery of such Unacceptable Waste.

Indemnización. Cliente acuerda indemnizar, mantener inmune, y defender Republic Services, Inc., sus subsidiarios, compañías, divisiones, empleados, oficiales y directores contra de cualquiera y de todas responsabilidades, demandas, penas, pérdidas, juicios, pleitos y los costos incidente además, incluyendo costos de defensa, de acuerdo judicial, y de honorarios razonables del abogado, que pueden ser incurridos en, o como resultado de, la muerte o herida personal a cualquier persona, o daños a cualquier característica, propiedad, contaminación de la tierra o efectos ilícitos en esta Facilidad, causado entero o en parte por el cliente, sus empleados, o sus subcontratistas en botar basura en esta Facilidad. En el caso que el Cliente entrega, bota, basura (según lo determinado por Republic) en este Establecimiento basura inaceptable en los reglamentos de este Establecimiento, el Cliente se compromete asumir todos los costos y obligaciones con el retiro y/o la resolución de cualquier dano(s) causado por la entrega de tal basura inaceptable.



NON-HAZARDOUS WASTE MANIFEST

MANIFEST # 11675

GENERATOR INFORMATION

Generator Name: Tronox LLC
Address: P.O. Box 55
City: Henderson County: Clark
State: NV Zip: 89009
Site Location (if different): 560 W. Lake Mead
Henderson, NV 89015 (702) 592-7727

CUSTOMER/BILLING INFORMATION

Billing Name: NGE LLC c/o Northgate Environment Management
Address: 300 Frank Ogawa Plaza, Ste 510
City: Oakland County: Alameda
State: CA Zip: 94612

Table with 5 columns: Republic Services Approval #, Description of Waste, Volume/Weight, Expiration Date, Container Type. Row 1: 38251011244, Soil for disposal, 34 99/100, 12-31-2011, Tractor with Dump Trailer(s).

*Attach Additional Sheet if necessary

I hereby certify that the above-described materials are non-hazardous wastes as defined by 40 CFR 261 or any applicable state law. Further, that the above named materials are properly classified, described, packaged, marked and labeled, and are in proper condition for transportation according to the applicable regulations of the Department of Transportation.

Susan Crowley (Signature)
Generator/Authorized Agent Name Signature Date Shipped

TRANSPORTER INFORMATION

Transporter Name: Las Vegas Paving DOT # 191949
Address: 4420 S. Decatur Truck Number: 125
Las Vegas, NV 89103 Phone Number: (702) 353-4355

I certify no hazardous waste or other regulated substance was knowingly introduced to the waste while in my custody. The waste transported in this vehicle is the waste identified above, to the best of my knowledge.

Calvin Paguyo (Signature)
Name of Authorized Agent Signature Date Delivered 10/03/10

DISPOSAL SITE INFORMATION

Site Name: Apex Regional Landfill Phone No. (702) 599-5920
Address: 13550 U.S. Hwy 93 Las Vegas, NV

I hereby acknowledge receipt of the above described materials
Holden, Se'Derrick (Signature)
Name (Print or Type) Signature Date Received 03 Oct 10

81 Environmental Tech
13550 N Highway 93
Las Vegas, NV 89165

Ticket Type: INBOUND INVOICE

Ticket Number: 1574
Date: 10/03/2010
Time In: 8:02 pm
Time Out: 8:27 pm

Customer: 001011 - NGE, LLC c/o Northgate Environ Mgmt

Vehicle/Container: 81495P
Contract: Northgate Env. On Site Soils 3825 11
Comment: 3825 10 11244

Gross Weight: 123,300 LB Manual In
Tare Weight: 50,360 LB Manual Out
Net Weight: 72940 LB
Net Tons: 36.47

BOL: 11676

Origin	Yards	Material	Billing Quantity
Not Applicable	0.00 YD	SW CONTAMINATED SOIL	36.47 TN

Driver:

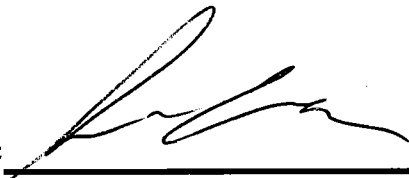

Weighmaster:

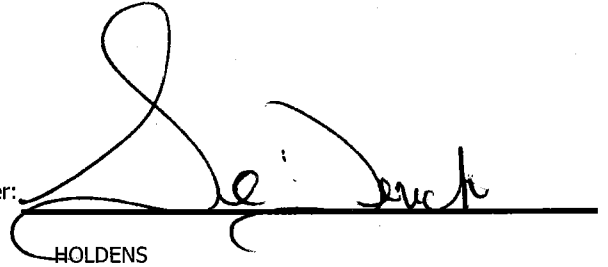

HOLDENS

Indemnification. Customer agrees, by signature above, to indemnify, hold harmless, and defend Republic Services, Inc., its subsidiaries, affiliates, employees, officers and directors from and against any and all liabilities, claims, penalties, forfeitures, suits and the costs and expenses incident thereto, including costs of defense, settlement, and reasonable attorney's fees, which may be incurred, as a result of death or injuries to any person, or damage to any property, contamination of or adverse effects on the environment, caused in whole or in part by the Customer, its employees, or subcontractors in disposing waste at this Facility. In the event Customer delivers Unacceptable Waste (as determined by Republic) Customer agrees to assume all expenses and obligations with the removal and/or resolution of any effects caused by the delivery of such Unacceptable Waste.

Indemnización. Cliente acuerda indemnizar, mantener inmune, y defender Republic Services, Inc., sus subsidiarios, compañías, divisiones, empleados, oficiales y directores contra de cualquiera y de todas responsabilidades, demandas, penas, pérdidas, juicios, pleitos y los costos incidente además, incluyendo costos de defensa, de acuerdo judicial, y de honorarios razonables del abogado, que pueden ser incurridos en, o como resultado de, la muerte o herida personal a cualquier persona, o daños a cualquier característica, propiedad, contaminación de la tierra o efectos ilícitos en esta Facilidad, causado entero o en parte por el cliente, sus empleados, o sus subcontratistas en botar basura en esta Facilidad. En el caso que el Cliente entrega, bota, basura (según lo determinado por Republic) en este Establecimiento basura inaceptable en los reglamentos de este Establecimiento, el Cliente se compromete asumir todos los costos y obligaciones con el retiro y/o la resolución de cualquier dano(s) causado por la entrega de tal basura inaceptable.



NON-HAZARDOUS WASTE MANIFEST

MANIFEST # 11676

GENERATOR INFORMATION

Generator Name: Tronox LLC

Address: P.O. Box 55

City: Henderson County: Clark

State: NV Zip: 89009

Site Location (if different): 560 W. Lake Mead
Henderson, NV 89015 (702) 592-7727

CUSTOMER/BILLING INFORMATION

Billing Name: NGE LLC c/o Northgate Environment Management

Address: 300 Frank Ogawa Plaza, Ste 510

City: Oakland County: Alameda

State: CA Zip: 94612

Republic Services Approval #	Description of Waste	Volume/Weight	Expiration Date	Container Type
38251011244	Soil for disposal	36 ⁴⁷ / ₁₅₀	12-31-2011	Tractor with Dump Trailer(s)
	RZ- _____ # _____			

*Attach Additional Sheet if necessary

I hereby certify that the above-described materials are non-hazardous wastes as defined by 40 CFR 261 or any applicable state law. Further, that the above named materials are properly classified, described, packaged, marked and labeled, and are in proper condition for transportation according to the applicable regulations of the Department of Transportation.

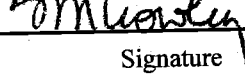
Susan Crowley 
Generator/Authorized Agent Name Signature Date Shipped

TRANSPORTER INFORMATION

Transporter Name: Las Vegas Paving

DOT # 191949

Address: 4420 S. Decatur

Truck Number: 175

Las Vegas, NV 89103

Phone Number: (702) 353-4355

I certify no hazardous waste or other regulated substance was knowingly introduced to the waste while in my custody. The waste transported in this vehicle is the waste identified above, to the best of my knowledge.

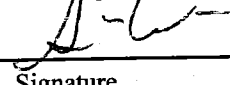
Andrew Walker 
Name of Authorized Agent Signature Date Delivered 10-3-10

DISPOSAL SITE INFORMATION

Site Name: Apex Regional Landfill

Phone No. (702) 599-5920

Address: 13550 U.S. Hwy 93 Las Vegas, NV

I hereby acknowledge receipt of the above described materials
Holden, Sa' Derrick 
Name (Print or Type) Signature Date Received 03 Oct 10

81 Environmental Tech
13550 N Highway 93
Las Vegas, NV 89165

Ticket Type: INBOUND INVOICE

Ticket Number: 1575
Date: 10/03/2010
Time In: 8:04 pm
Time Out: 8:31 pm

Customer: 001011 - NGE, LLC c/o Northgate Environ Mgmt

Vehicle/Container: 43099A
Contract: Northgate Env. On Site Soils 3825 11
Comment: 3825 10 11244

Gross Weight: 124,920 LB Manual In
Tare Weight: 54,640 LB Scale Out
Net Weight: 70280 LB
Net Tons: 35.14

BOL: 11677

Origin	Yards	Material	Billing Quantity
Not Applicable	0.00 YD	SW CONTAMINATED SOIL	35.14 TN

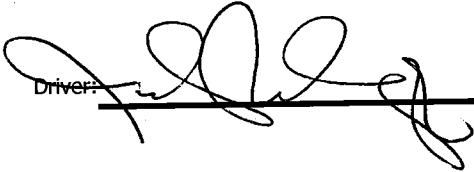
Driver: 

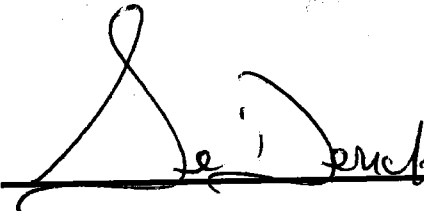
Weighmaster: 
HOLDENS

Indemnification. Customer agrees, by signature above, to indemnify, hold harmless, and defend Republic Services, Inc., its subsidiaries, affiliates, employees, officers and directors from and against any and all liabilities, claims, penalties, forfeitures, suits and the costs and expenses incident thereto, including costs of defense, settlement, and reasonable attorney's fees, which may be incurred, as a result of death or injuries to any person, or damage to any property, contamination of or adverse effects on the environment, caused in whole or in part by the Customer, its employees, or subcontractors in disposing waste at this Facility. In the event Customer delivers Unacceptable Waste (as determined by Republic) Customer agrees to assume all expenses and obligations with the removal and/or resolution of any effects caused by the delivery of such Unacceptable Waste.

Indemnización. Cliente acuerda indemnizar, mantener inmune, y defender Republic Services, Inc., sus subsidiarios, compañías, divisiones, empleados, oficiales y directores contra de cualquiera y de todas responsabilidades, demandas, penas, pérdidas, juicios, pleitos y los costos incidente además, incluyendo costos de defensa, de acuerdo judicial, y de honorarios razonables del abogado, que pueden ser incurridos en, o como resultado de, la muerte o herida personal a cualquier persona, o daños a cualquier característica, propiedad, contaminación de la tierra o efectos ilícitos en esta Facilidad, causado entero o en parte por el cliente, sus empleados, o sus subcontratistas en botar basura en esta Facilidad. En el caso que el Cliente entrega, bota, basura (según lo determinado por Republic) en este Establecimiento basura inaceptable en los reglamentos de este Establecimiento, el Cliente se compromete asumir todos los costos y obligaciones con el retiro y/o la resolución de cualquier dano(s) causado por la entrega de tal basura inaceptable.



NON-HAZARDOUS WASTE MANIFEST

MANIFEST # 11677

GENERATOR INFORMATION

Generator Name: Tronox LLC
Address: P.O. Box 55
City: Henderson County: Clark
State: NV Zip: 89009
Site Location (if different): 560 W. Lake Mead
Henderson, NV 89015 (702) 592-7727

CUSTOMER/BILLING INFORMATION

Billing Name: NGE LLC c/o Northgate Environment Management
Address: 300 Frank Ogawa Plaza, Ste 510
City: Oakland County: Alameda
State: CA Zip: 94612

Table with 5 columns: Republic Services Approval #, Description of Waste, Volume/Weight, Expiration Date, Container Type. Row 1: 38251011244, Soil for disposal, 35 1/2 TON, 12-31-2011, Tractor with Dump Trailer(s).

*Attach Additional Sheet if necessary

I hereby certify that the above-described materials are non-hazardous wastes as defined by 40 CFR 261 or any applicable state law. Further, that the above named materials are properly classified, described, packaged, marked and labeled, and are in proper condition for transportation according to the applicable regulations of the Department of Transportation.

Susan Crowley (Signature)
Generator/Authorized Agent Name Signature Date Shipped

TRANSPORTER INFORMATION

Transporter Name: Las Vegas Paving DOT # 191949
Address: 4420 S. Decatur Truck Number: 3506 #6
Las Vegas, NV 89103 Phone Number: (702) 353-4355

I certify no hazardous waste or other regulated substance was knowingly introduced to the waste while in my custody. The waste transported in this vehicle is the waste identified above, to the best of my knowledge.

James Lahenka (Signature)
Name of Authorized Agent Signature Date Delivered 10/3/10

DISPOSAL SITE INFORMATION

Site Name: Apex Regional Landfill Phone No. (702) 599-5920
Address: 13550 U.S. Hwy 93 Las Vegas, NV

I hereby acknowledge receipt of the above described materials
Holden Se' Derick (Signature)
Name (Print or Type) Signature Date Received 03 Oct 10

81 Environmental Tech
13550 N Highway 93
Las Vegas, NV 89165

Ticket Type: INBOUND INVOICE

Ticket Number: 1576
Date: 10/03/2010
Time In: 8:10 pm
Time Out: 8:36 pm

Customer: 001011 - NGE, LLC c/o Northgate Environ Mgmt

Vehicle/Container: 81496P
Contract: Northgate Env. On Site Soils 3825 11
Comment: 3825 10 11244

Gross Weight: 119,200 LB Manual In
Tare Weight: 50,260 LB Manual Out
Net Weight: 68940 LB
Net Tons: 34.47

BOL: 11678

Origin	Yards	Material	Billing	Quantity
Not Applicable	0.00 YD	SW CONTAMINATED SOIL	34.47	TN

Driver: _____

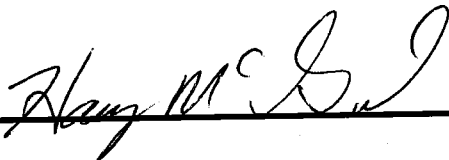

Weighmaster: _____

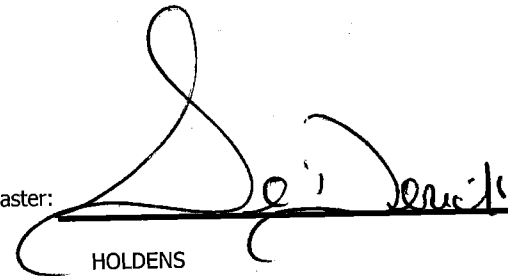
HOLDENS

Indemnification. Customer agrees, by signature above, to indemnify, hold harmless, and defend Republic Services, Inc., its subsidiaries, affiliates, employees, officers and directors from and against any and all liabilities, claims, penalties, forfeitures, suits and the costs and expenses incident thereto, including costs of defense, settlement, and reasonable attorney's fees, which may be incurred, as a result of death or injuries to any person, or damage to any property, contamination of or adverse effects on the environment, caused in whole or in part by the Customer, its employees, or subcontractors in disposing waste at this Facility. In the event Customer delivers Unacceptable Waste (as determined by Republic) Customer agrees to assume all expenses and obligations with the removal and/or resolution of any effects caused by the delivery of such Unacceptable Waste.

Indemnización. Cliente acuerda indemnizar, mantener inmune, y defender Republic Services, Inc., sus subsidiarios, compañías, divisiones, empleados, oficiales y directores contra de cualquiera y de todas responsabilidades, demandas, penas, pérdidas, juicios, pleitos y los costos incidente además, incluyendo costos de defensa, de acuerdo judicial, y de honorarios razonables del abogado, que pueden ser incurridos en, o como resultado de, la muerte o herida personal a cualquier persona, o daños a cualquier característica, propiedad, contaminación de la tierra o efectos ilícitos en esta Facilidad, causado entero o en parte por el cliente, sus empleados, o sus subcontratistas en botar basura en esta Facilidad. En el caso que el Cliente entrega, bota, basura (según lo determinado por Republic) en este Establecimiento basura inaceptable en los reglamentos de este Establecimiento, el Cliente se compromete asumir todos los costos y obligaciones con el retiro y/o la resolución de cualquier dano(s) causado por la entrega de tal basura inaceptable.



NON-HAZARDOUS WASTE MANIFEST

MANIFEST # 11578

GENERATOR INFORMATION

Generator Name: Tronox LLC
Address: P.O. Box 55
City: Henderson County: Clark
State: NV Zip: 89009
Site Location (if different): 560 W. Lake Mead
Henderson, NV 89015 (702) 592-7727

CUSTOMER/BILLING INFORMATION

Billing Name: NGE LLC c/o Northgate Environment Management
Address: 300 Frank Ogawa Plaza, Ste 510
City: Oakland County: Alameda
State: CA Zip: 94612

Table with 5 columns: Republic Services Approval #, Description of Waste, Volume/Weight, Expiration Date, Container Type. Row 1: 38251011244, Soil for disposal, 34 47/ton, 12-31-2011, Tractor with Dump Trailer(s)

*Attach Additional Sheet if necessary

I hereby certify that the above-described materials are non-hazardous wastes as defined by 40 CFR 261 or any applicable state law. Further, that the above named materials are properly classified, described, packaged, marked and labeled, and are in proper condition for transportation according to the applicable regulations of the Department of Transportation.

Susan Crowley (Generator/Authorized Agent Name), Tom Crowley (Signature), Date Shipped

TRANSPORTER INFORMATION

Transporter Name: Las Vegas Paving DOT # 191949
Address: 4420 S. Decatur Truck Number: 145
Las Vegas, NV 89103 Phone Number: (702) 353-4355

I certify no hazardous waste or other regulated substance was knowingly introduced to the waste while in my custody. The waste transported in this vehicle is the waste identified above, to the best of my knowledge.

Harry McPhee (Name of Authorized Agent), Harry McPhee (Signature), 10-3-10 (Date Delivered)

DISPOSAL SITE INFORMATION

Site Name: Apex Regional Landfill Phone No. (702) 599-5920
Address: 13550 U.S. Hwy 93 Las Vegas, NV

I hereby acknowledge receipt of the above described materials
Holden, So Derick (Name), So Derick Holden (Signature), 03 Oct 10 (Date Received)

81 Environmental Tech
13550 N Highway 93
Las Vegas, NV 89165

Ticket Type: INBOUND INVOICE

Ticket Number: 1577
Date: 10/03/2010
Time In: 8:15 pm
Time Out: 8:42 pm

Customer: 001011 - NGE, LLC c/o Northgate Environ Mgmt

Vehicle/Container: 81460P
Contract: Northgate Env. On Site Soils 3825 11
Comment: 3825 10 11244

Gross Weight: 121,820 LB Manual In
Tare Weight: 52,600 LB Scale Out
Net Weight: 69220 LB
Net Tons: 34.61

BOL: 11679

Origin	Yards	Material	Billing Quantity
Not Applicable	0.00 YD	SW CONTAMINATED SOIL	34.61 TN

Driver: _____

Weighmaster: _____

HOLDENS

Indemnification. Customer agrees, by signature above, to indemnify, hold harmless, and defend Republic Services, Inc., its subsidiaries, affiliates, employees, officers and directors from and against any and all liabilities, claims, penalties, forfeitures, suits and the costs and expenses incident thereto, including costs of defense, settlement, and reasonable attorney's fees, which may be incurred, as a result of death or injuries to any person, or damage to any property, contamination of or adverse effects on the environment, caused in whole or in part by the Customer, its employees, or subcontractors in disposing waste at this Facility. In the event Customer delivers Unacceptable Waste (as determined by Republic) Customer agrees to assume all expenses and obligations with the removal and/or resolution of any effects caused by the delivery of such Unacceptable Waste.

Indemnización. Cliente acuerda indemnizar, mantener inmune, y defender Republic Services, Inc., sus subsidiarios, compañías, divisiones, empleados, oficiales y directores contra de cualquiera y de todas responsabilidades, demandas, penas, pérdidas, juicios, pleitos y los costos incidente además, incluyendo costos de defensa, de acuerdo judicial, y de honorarios razonables del abogado, que pueden ser incurridos en, o como resultado de, la muerte o herida personal a cualquier persona, o daños a cualquier característica, propiedad, contaminación de la tierra o efectos ilícitos en esta Facilidad, causado entero o en parte por el cliente, sus empleados, o sus subcontratistas en botar basura en esta Facilidad. En el caso que el Cliente entrega, bota, basura (según lo determinado por Republic) en este Establecimiento basura inaceptable en los reglamentos de este Establecimiento, el Cliente se compromete asumir todos los costos y obligaciones con el retiro y/o la resolución de cualquier dano(s) causado por la entrega de tal basura inaceptable.



NON-HAZARDOUS WASTE MANIFEST

MANIFEST # 11679

GENERATOR INFORMATION

Generator Name: Tronox LLC
Address: P.O. Box 55
City: Henderson County: Clark
State: NV Zip: 89009
Site Location (if different): 560 W. Lake Mead
Henderson, NV 89015 (702) 592-7727

CUSTOMER/BILLING INFORMATION

Billing Name: NGE LLC c/o Northgate Environment Management
Address: 300 Frank Ogawa Plaza, Ste 510
City: Oakland County: Alameda
State: CA Zip: 94612

Table with 5 columns: Republic Services Approval #, Description of Waste, Volume/Weight, Expiration Date, Container Type. Row 1: 38251011244, Soil for disposal, 34 6/10 tons, 12-31-2011, Tractor with Dump Trailer(s)

*Attach Additional Sheet if necessary

I hereby certify that the above-described materials are non-hazardous wastes as defined by 40 CFR 261 or any applicable state law. Further, that the above named materials are properly classified, described, packaged, marked and labeled, and are in proper condition for transportation according to the applicable regulations of the Department of Transportation.

Susan Crowley
Generator/Authorized Agent Name Signature Date Shipped

TRANSPORTER INFORMATION

Transporter Name: Las Vegas Paving DOT # 191949
Address: 4420 S. Decatur Truck Number: 27
Las Vegas, NV 89103 Phone Number: (702) 353-4355

I certify no hazardous waste or other regulated substance was knowingly introduced to the waste while in my custody. The waste transported in this vehicle is the waste identified above, to the best of my knowledge.

Daniel Carson
Name of Authorized Agent Signature Date Delivered 10-3-2010

DISPOSAL SITE INFORMATION

Site Name: Apex Regional Landfill Phone No. (702) 599-5920
Address: 13550 U.S. Hwy 93 Las Vegas, NV

I hereby acknowledge receipt of the above described materials
Name (Print or Type) Signature Date Received 03 Oct 10

81 Environmental Tech
13550 N Highway 93
Las Vegas, NV 89165

Ticket Type: INBOUND INVOICE

Ticket Number: 1578
Date: 10/03/2010
Time In: 8:24 pm
Time Out: 8:44 pm

Customer: 001011 - NGE, LLC c/o Northgate Environ Mgmt

Vehicle/Container: 82418P
Contract: Northgate Env. On Site Soils 3825 11
Comment: 3825 10 11244

Gross Weight: 132,860 LB Manual In
Tare Weight: 60,420 LB Manual Out
Net Weight: 72,440 LB
Net Tons: 36.22

BOL: 11682

Origin	Yards	Material	Billing Quantity
Not Applicable	0.00 YD	SW CONTAMINATED SOIL	36.22 TN

Driver:

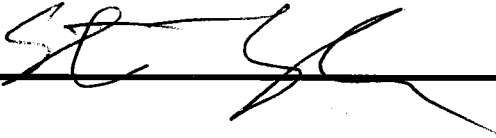

Weighmaster:

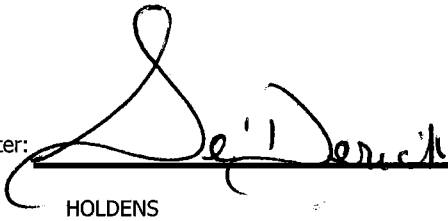

HOLDENS

Indemnification. Customer agrees, by signature above, to indemnify, hold harmless, and defend Republic Services, Inc., its subsidiaries, affiliates, employees, officers and directors from and against any and all liabilities, claims, penalties, forfeitures, suits and the costs and expenses incident thereto, including costs of defense, settlement, and reasonable attorney's fees, which may be incurred, as a result of death or injuries to any person, or damage to any property, contamination of or adverse effects on the environment, caused in whole or in part by the Customer, its employees, or subcontractors in disposing waste at this Facility. In the event Customer delivers Unacceptable Waste (as determined by Republic) Customer agrees to assume all expenses and obligations with the removal and/or resolution of any effects caused by the delivery of such Unacceptable Waste.

Indemnización. Cliente acuerda indemnizar, mantener inmune, y defender Republic Services, Inc., sus subsidiarios, compañías, divisiones, empleados, oficiales y directores contra de cualquiera y de todas responsabilidades, demandas, penas, pérdidas, juicios, pleitos y los costos incidente además, incluyendo costos de defensa, de acuerdo judicial, y de honorarios razonables del abogado, que pueden ser incurridos en, o como resultado de, la muerte o herida personal a cualquier persona, o daños a cualquier característica, propiedad, contaminación de la tierra o efectos ilícitos en esta Facilidad, causado entero o en parte por el cliente, sus empleados, o sus subcontratistas en botar basura en esta Facilidad. En el caso que el Cliente entrega, bota, basura (según lo determinado por Republic) en este Establecimiento basura inaceptable en los reglamentos de este Establecimiento, el Cliente se compromete asumir todos los costos y obligaciones con el retiro y/o la resolución de cualquier dano(s) causado por la entrega de tal basura inaceptable.



NON-HAZARDOUS WASTE MANIFEST

MANIFEST # 11682

GENERATOR INFORMATION

Generator Name: Tronox LLC

Address: P.O. Box 55

City: Henderson County: Clark

State: NV Zip: 89009

Site Location (if different): 560 W. Lake Mead

Henderson, NV 89015 (702) 592-7727

CUSTOMER/BILLING INFORMATION

Billing Name: NGE LLC c/o Northgate Environment Management

Address: 300 Frank Ogawa Plaza, Ste 510

City: Oakland County: Alameda

State: CA Zip: 94612

Table with 5 columns: Republic Services Approval #, Description of Waste, Volume/Weight, Expiration Date, Container Type. Row 1: 38251011244, Soil for disposal, 36 22/70n, 12-31-2011, Tractor with Dump Trailer(s).

*Attach Additional Sheet if necessary

I hereby certify that the above-described materials are non-hazardous wastes as defined by 40 CFR 261 or any applicable state law. Further, that the above named materials are properly classified, described, packaged, marked and labeled, and are in proper condition for transportation according to the applicable regulations of the Department of Transportation.

Susan Crowley (Signature) Generator/Authorized Agent Name Date Shipped

TRANSPORTER INFORMATION

Transporter Name: Las Vegas Paving

DOT # 191949

Address: 4420 S. Decatur

Truck Number: 220

Las Vegas, NV 89103

Phone Number: (702) 353-4355

I certify no hazardous waste or other regulated substance was knowingly introduced to the waste while in my custody. The waste transported in this vehicle is the waste identified above, to the best of my knowledge.

STEVE TAYLOR (Signature) Date Delivered 10-3-10

DISPOSAL SITE INFORMATION

Site Name: Apex Regional Landfill

Phone No. (702) 599-5920

Address: 13550 U.S. Hwy 93 Las Vegas, NV

I hereby acknowledge receipt of the above described materials

Holden Se' Derick (Signature) Date Received 03 Oct 10

81 Environmental Tech
13550 N Highway 93
Las Vegas, NV 89165

Ticket Type: INBOUND INVOICE

Ticket Number: 1579
Date: 10/03/2010
Time In: 8:30 pm
Time Out: 8:52 pm

Customer: 001011 - NGE, LLC c/o Northgate Environ Mgmt

Vehicle/Container: 86053P
Contract: Northgate Env. On Site Soils 3825 11
Comment: 3825 10 11244

Gross Weight: 125,520 LB Manual In
Tare Weight: 54,620 LB Scale Out
Net Weight: 70900 LB
Net Tons: 35.45

BOL: 11683

Origin	Yards	Material	Billing	Quantity
Not Applicable	0.00 YD	SW CONTAMINATED SOIL	35.45	TN

Driver: _____

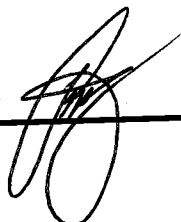

Weighmaster: _____

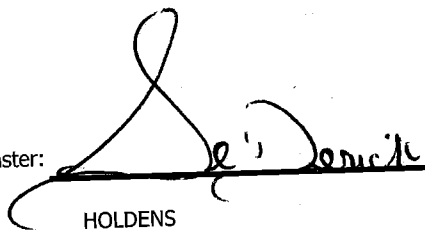
HOLDENS

Indemnification. Customer agrees, by signature above, to indemnify, hold harmless, and defend Republic Services, Inc., its subsidiaries, affiliates, employees, officers and directors from and against any and all liabilities, claims, penalties, forfeitures, suits and the costs and expenses incident thereto, including costs of defense, settlement, and reasonable attorney's fees, which may be incurred, as a result of death or injuries to any person, or damage to any property, contamination of or adverse effects on the environment, caused in whole or in part by the Customer, its employees, or subcontractors in disposing waste at this Facility. In the event Customer delivers Unacceptable Waste (as determined by Republic) Customer agrees to assume all expenses and obligations with the removal and/or resolution of any effects caused by the delivery of such Unacceptable Waste.

Indemnización. Cliente acuerda indemnizar, mantener inmune, y defender Republic Services, Inc., sus subsidiarios, compañías, divisiones, empleados, oficiales y directores contra de cualquiera y de todas responsabilidades, demandas, penas, pérdidas, juicios, pleitos y los costos incidente además, incluyendo costos de defensa, de acuerdo judicial, y de honorarios razonables del abogado, que pueden ser incurridos en, o como resultado de, la muerte o herida personal a cualquier persona, o daños a cualquier característica, propiedad, contaminación de la tierra o efectos ilícitos en esta Facilidad, causado entero o en parte por el cliente, sus empleados, o sus subcontratistas en botar basura en esta Facilidad. En el caso que el Cliente entrega, bota, basura (según lo determinado por Republic) en este Establecimiento basura inaceptable en los reglamentos de este Establecimiento, el Cliente se compromete asumir todos los costos y obligaciones con el retiro y/o la resolución de cualquier dano(s) causado por la entrega de tal basura inaceptable.



NON-HAZARDOUS WASTE MANIFEST MANIFEST # 11683

GENERATOR INFORMATION

Generator Name: Tronox LLC
 Address: P.O. Box 55
 City: Henderson County: Clark
 State: NV Zip: 89009
 Site Location (if different): 560 W. Lake Mead
Henderson, NV 89015 (702) 592-7727

CUSTOMER/BILLING INFORMATION

Billing Name: NGE LLC c/o Northgate Environment Management
 Address: 300 Frank Ogawa Plaza, Ste 510
 City: Oakland County: Alameda
 State: CA Zip: 94612

Republic Services Approval #	Description of Waste	Volume/Weight	Expiration Date	Container Type
38251011244	Soil for disposal	35 ⁴⁵ / _{TON}	12-31-2011	Tractor with Dump Trailer(s)
	RZ- _____ # _____			

*Attach Additional Sheet if necessary

I hereby certify that the above-described materials are non-hazardous wastes as defined by 40 CFR 261 or any applicable state law. Further, that the above named materials are properly classified, described, packaged, marked and labeled, and are in proper condition for transportation according to the applicable regulations of the Department of Transportation.

Susan Crowley *Susan Crowley* _____
 Generator/Authorized Agent Name Signature Date Shipped

TRANSPORTER INFORMATION

Transporter Name: Las Vegas Paving DOT # 191949
 Address: 4420 S. Decatur Truck Number: 261
Las Vegas, NV 89103 Phone Number: (702) 353-4355

I certify no hazardous waste or other regulated substance was knowingly introduced to the waste while in my custody. The waste transported in this vehicle is the waste identified above, to the best of my knowledge.

Patrick Jones *Patrick Jones* 3 Oct 18
 Name of Authorized Agent Signature Date Delivered

DISPOSAL SITE INFORMATION

Site Name: Apex Regional Landfill Phone No. (702) 599-5920
 Address: 13550 U.S. Hwy 93 Las Vegas, NV

I hereby acknowledge receipt of the above described materials
Holden, SeDerrick *SeDerrick Holden* 03 Oct 18
 Name (Print or Type) Signature Date Received

81 Environmental Tech
13550 N Highway 93
Las Vegas, NV 89165

Ticket Type: INBOUND INVOICE

Ticket Number: 1580
Date: 10/03/2010
Time In: 8:27 pm
Time Out: 8:56 pm

Customer: 001011 - NGE, LLC c/o Northgate Environ Mgmt

Vehicle/Container: 86113P
Contract: Northgate Env. On Site Soils 3825 11
Comment: 3825 10 11244

Gross Weight: 139,800 LB Manual In
Tare Weight: 55,720 LB Scale Out
Net Weight: 84080 LB
Net Tons: 42.04

BOL: 11681

Origin	Yards	Material	Billing Quantity
Not Applicable	0.00 YD	SW CONTAMINATED SOIL	42.04 TN

Driver:

J. A. H.

Weighmaster:

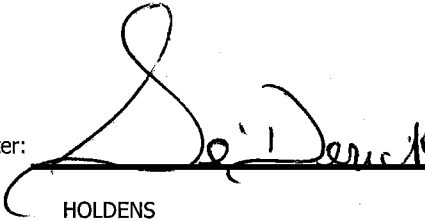
HOLDENS

Indemnification. Customer agrees, by signature above, to indemnify, hold harmless, and defend Republic Services, Inc., its subsidiaries, affiliates, employees, officers and directors from and against any and all liabilities, claims, penalties, forfeitures, suits and the costs and expenses incident thereto, including costs of defense, settlement, and reasonable attorney's fees, which may be incurred, as a result of death or injuries to any person, or damage to any property, contamination of or adverse effects on the environment, caused in whole or in part by the Customer, its employees, or subcontractors in disposing waste at this Facility. In the event Customer delivers Unacceptable Waste (as determined by Republic) Customer agrees to assume all expenses and obligations with the removal and/or resolution of any effects caused by the delivery of such Unacceptable Waste.

Indemnización. Cliente acuerda indemnizar, mantener inmune, y defender Republic Services, Inc., sus subsidiarios, compañías, divisiones, empleados, oficiales y directores contra de cualquiera y de todas responsabilidades, demandas, penas, pérdidas, juicios, pleitos y los costos incidente además, incluyendo costos de defensa, de acuerdo judicial, y de honorarios razonables del abogado, que pueden ser incurridos en, o como resultado de, la muerte o herida personal a cualquier persona, o daños a cualquier característica, propiedad, contaminación de la tierra o efectos ilícitos en esta Facilidad, causado entero o en parte por el cliente, sus empleados, o sus subcontratistas en botar basura en esta Facilidad. En el caso que el Cliente entrega, bota, basura (según lo determinado por Republic) en este Establecimiento basura inaceptable en los reglamentos de este Establecimiento, el Cliente se compromete asumir todos los costos y obligaciones con el retiro y/o la resolución de cualquier dano(s) causado por la entrega de tal basura inaceptable.



NON-HAZARDOUS WASTE MANIFEST

MANIFEST # 11681

GENERATOR INFORMATION

Generator Name: Tronox LLC

Address: P.O. Box 55

City: Henderson County: Clark

State: NV Zip: 89009

Site Location (if different): 560 W. Lake Mead

Henderson, NV 89015 (702) 592-7727

CUSTOMER/BILLING INFORMATION

Billing Name: NGE LLC c/o Northgate Environment Management

Address: 300 Frank Ogawa Plaza, Ste 510

City: Oakland County: Alameda

State: CA Zip: 94612

Republic Services Approval #	Description of Waste	Volume/Weight	Expiration Date	Container Type
38251011244	Soil for disposal	42.04 / ton	12-31-2011	Tractor with Dump Trailer(s)
	RZ- #			

*Attach Additional Sheet if necessary

I hereby certify that the above-described materials are non-hazardous wastes as defined by 40 CFR 261 or any applicable state law. Further, that the above named materials are properly classified, described, packaged, marked and labeled, and are in proper condition for transportation according to the applicable regulations of the Department of Transportation.

Susan Crowley (Signature) Generator/Authorized Agent Name Date Shipped

TRANSPORTER INFORMATION

Transporter Name: Las Vegas Paving

DOT # 191949

Address: 4420 S. Decatur

Truck Number: K001A 17

Las Vegas, NV 89103

Phone Number: (702) 353-4355

I certify no hazardous waste or other regulated substance was knowingly introduced to the waste while in my custody. The waste transported in this vehicle is the waste identified above, to the best of my knowledge.

ALBERTO HERRERA (Signature) Date Delivered Oct 3, 2010

DISPOSAL SITE INFORMATION

Site Name: Apex Regional Landfill

Phone No. (702) 599-5920

Address: 13550 U.S. Hwy 93 Las Vegas, NV

I hereby acknowledge receipt of the above described materials (Signature) Date Received 03 Oct 2010

81 Environmental Tech
13550 N Highway 93
Las Vegas, NV 89165

Ticket Type: INBOUND INVOICE

Ticket Number: 1581
Date: 10/03/2010
Time In: 8:35 pm
Time Out: 8:56 pm

Customer: 001011 - NGE, LLC c/o Northgate Environ Mgmt

Vehicle/Container: 76811P
Contract: Northgate Env. On Site Soils 3825 11
Comment: 3825 10 11244

Gross Weight: 121,780 LB Manual In
Tare Weight: 53,180 LB Manual Out
Net Weight: 68600 LB
Net Tons: 34.30

BOL: 11685

Origin	Yards	Material	Billing	Quantity
Not Applicable	0.00 YD	SW CONTAMINATED SOIL	34.30	TN

Driver: _____

Weighmaster: _____

HOLDENS

Indemnification. Customer agrees, by signature above, to indemnify, hold harmless, and defend Republic Services, Inc., its subsidiaries, affiliates, employees, officers and directors from and against any and all liabilities, claims, penalties, forfeitures, suits and the costs and expenses incident thereto, including costs of defense, settlement, and reasonable attorney's fees, which may be incurred, as a result of death or injuries to any person, or damage to any property, contamination of or adverse effects on the environment, caused in whole or in part by the Customer, its employees, or subcontractors in disposing waste at this Facility. In the event Customer delivers Unacceptable Waste (as determined by Republic) Customer agrees to assume all expenses and obligations with the removal and/or resolution of any effects caused by the delivery of such Unacceptable Waste.

Indemnización. Cliente acuerda indemnizar, mantener inmune, y defender Republic Services, Inc., sus subsidiarios, compañías, divisiones, empleados, oficiales y directores contra de cualquiera y de todas responsabilidades, demandas, penas, pérdidas, juicios, pleitos y los costos incidente además, incluyendo costos de defensa, de acuerdo judicial, y de honorarios razonables del abogado, que pueden ser incurridos en, o como resultado de, la muerte o herida personal a cualquier persona, o daños a cualquier característica, propiedad, contaminación de la tierra o efectos ilícitos en esta Facilidad, causado entero o en parte por el cliente, sus empleados, o sus subcontratistas en botar basura en esta Facilidad. En el caso que el Cliente entrega, bota, basura (según lo determinado por Republic) en este Establecimiento basura inaceptable en los reglamentos de este Establecimiento, el Cliente se compromete asumir todos los costos y obligaciones con el retiro y/o la resolución de cualquier dano(s) causado por la entrega de tal basura inaceptable.



NON-HAZARDOUS WASTE MANIFEST

MANIFEST # 11685**GENERATOR INFORMATION**

Generator Name: Tronox LLC
Address: P.O. Box 55
City: Henderson County: Clark
State: NV Zip: 89009
Site Location (if different): 560 W. Lake Mead
Henderson, NV 89015 (702) 592-7727

CUSTOMER/BILLING INFORMATION

Billing Name: NGE LLC c/o Northgate Environment Management
Address: 300 Frank Ogawa Plaza, Ste 510
City: Oakland County: Alameda
State: CA Zip: 94612

Republic Services Approval #	Description of Waste	Volume/Weight	Expiration Date	Container Type
38251011244	Soil for disposal	34 ³⁰ ton	12-31-2011	Tractor with Dump Trailer(s)
	RZ- _____ # _____			

*Attach Additional Sheet if necessary

I hereby certify that the above-described materials are non-hazardous wastes as defined by 40 CFR 261 or any applicable state law. Further, that the above named materials are properly classified, described, packaged, marked and labeled, and are in proper condition for transportation according to the applicable regulations of the Department of Transportation.

Susan Crowley [Signature] _____
Generator/Authorized Agent Name Signature Date Shipped

TRANSPORTER INFORMATION

Transporter Name: Las Vegas Paving DOT # 191949
Address: 4420 S. Decatur Truck Number: 242
Las Vegas, NV 89103 Phone Number: (702) 353-4355

I certify no hazardous waste or other regulated substance was knowingly introduced to the waste while in my custody. The waste transported in this vehicle is the waste identified above, to the best of my knowledge.

[Signature] STEVEN HAYES 10-3-10
Name of Authorized Agent Signature Date Delivered

DISPOSAL SITE INFORMATION

Site Name: Apex Regional Landfill Phone No. (702) 599-5920
Address: 13550 U.S. Hwy 93 Las Vegas, NV

I hereby acknowledge receipt of the above described materials
[Signature] _____
Name (Print or Type) Signature Date Received 03 Oct 10

81 Environmental Tech
13550 N Highway 93
Las Vegas, NV 89165

Ticket Type: INBOUND INVOICE

Ticket Number: 1582
Date: 10/03/2010
Time In: 8:37 pm
Time Out: 8:58 pm

Customer: 001011 - NGE, LLC c/o Northgate Environ Mgmt

Vehicle/Container: 76810P
Contract: Northgate Env. On Site Soils 3825 11
Comment: 3825 10 11244

Gross Weight: 125,640 LB Manual In
Tare Weight: 54,480 LB Scale Out
Net Weight: 71160 LB
Net Tons: 35.58

BOL: 11686

Origin	Yards	Material	Billing	Quantity
Not Applicable	0.00 YD	SW CONTAMINATED SOIL	35.58	TN

Driver:

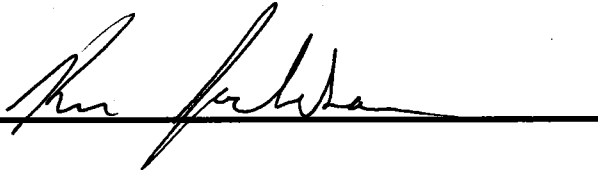

Weighmaster:

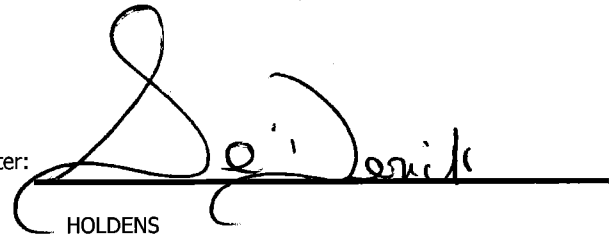

HOLDENS

Indemnification. Customer agrees, by signature above, to indemnify, hold harmless, and defend Republic Services, Inc., its subsidiaries, affiliates, employees, officers and directors from and against any and all liabilities, claims, penalties, forfeitures, suits and the costs and expenses incident thereto, including costs of defense, settlement, and reasonable attorney's fees, which may be incurred, as a result of death or injuries to any person, or damage to any property, contamination of or adverse effects on the environment, caused in whole or in part by the Customer, its employees, or subcontractors in disposing waste at this Facility. In the event Customer delivers Unacceptable Waste (as determined by Republic) Customer agrees to assume all expenses and obligations with the removal and/or resolution of any effects caused by the delivery of such Unacceptable Waste.

Indemnización. Cliente acuerda indemnizar, mantener inmune, y defender Republic Services, Inc., sus subsidiarios, compañías, divisiones, empleados, oficiales y directores contra de cualquiera y de todas responsabilidades, demandas, penas, pérdidas, juicios, pleitos y los costos incidente además, incluyendo costos de defensa, de acuerdo judicial, y de honorarios razonables del abogado, que pueden ser incurridos en, o como resultado de, la muerte o herida personal a cualquier persona, o daños a cualquier característica, propiedad, contaminación de la tierra o efectos ilícitos en esta Facilidad, causado entero o en parte por el cliente, sus empleados, o sus subcontratistas en botar basura en esta Facilidad. En el caso que el Cliente entrega, bota, basura (según lo determinado por Republic) en este Establecimiento basura inaceptable en los reglamentos de este Establecimiento, el Cliente se compromete asumir todos los costos y obligaciones con el retiro y/o la resolución de cualquier dano(s) causado por la entrega de tal basura inaceptable.



NON-HAZARDOUS WASTE MANIFEST

MANIFEST # 11686

GENERATOR INFORMATION

Generator Name: Tronox LLC

Address: P.O. Box 55

City: Henderson County: Clark

State: NV Zip: 89009

Site Location (if different): 560 W. Lake Mead

Henderson, NV 89015 (702) 592-7727

CUSTOMER/BILLING INFORMATION

Billing Name: NGE LLC c/o Northgate Environment Management

Address: 300 Frank Ogawa Plaza, Ste 510

City: Oakland County: Alameda

State: CA Zip: 94612

Republic Services Approval #	Description of Waste	Volume/Weight	Expiration Date	Container Type
38251011244	Soil for disposal	35 ⁵³ / ₇₅	12-31-2011	Tractor with Dump Trailer(s)
	RZ- _____ # _____			

*Attach Additional Sheet if necessary

I hereby certify that the above-described materials are non-hazardous wastes as defined by 40 CFR 261 or any applicable state law. Further, that the above named materials are properly classified, described, packaged, marked and labeled, and are in proper condition for transportation according to the applicable regulations of the Department of Transportation.

Susan Crowley
Generator/Authorized Agent Name

[Signature]
Signature

Date Shipped

TRANSPORTER INFORMATION

Transporter Name: Las Vegas Paving

DOT # 191949

Address: 4420 S. Decatur

Truck Number: 241

Las Vegas, NV 89103

Phone Number: (702) 353-4355

I certify no hazardous waste or other regulated substance was knowingly introduced to the waste while in my custody. The waste transported in this vehicle is the waste identified above, to the best of my knowledge.

[Signature]
Name of Authorized Agent

[Signature]
Signature

10-3-2010
Date Delivered

DISPOSAL SITE INFORMATION

Site Name: Apex Regional Landfill

Phone No. (702) 599-5920

Address: 13550 U.S. Hwy 93 Las Vegas, NV

I hereby acknowledge receipt of the above described materials

Holden Se Dorich
Name (Print or Type)

[Signature]
Signature

03 Oct 10
Date Received

81 Environmental Tech
13550 N Highway 93
Las Vegas, NV 89165

Ticket Type: INBOUND INVOICE

Ticket Number: 1583
Date: 10/03/2010
Time In: 8:35 pm
Time Out: 9:04 pm

Customer: 001011 - NGE, LLC c/o Northgate Environ Mgmt

Vehicle/Container: 68263P
Contract: Northgate Env. On Site Soils 3825 11
Comment: 3825 10 11244

Gross Weight: 120,240 LB Manual In
Tare Weight: 53,580 LB Manual Out
Net Weight: 66660 LB
Net Tons: 33.33

BOL: 11684

Origin	Yards	Material	Billing Quantity
Not Applicable	0.00 YD	SW CONTAMINATED SOIL	33.33 TN

Driver:

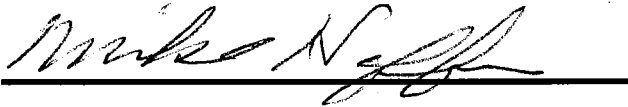

Weighmaster:

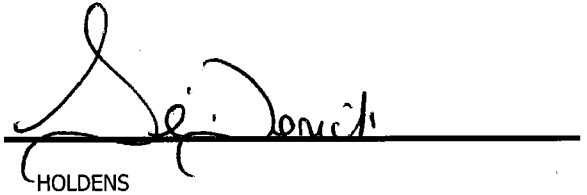

HOLDENS

Indemnification. Customer agrees, by signature above, to indemnify, hold harmless, and defend Republic Services, Inc., its subsidiaries, affiliates, employees, officers and directors from and against any and all liabilities, claims, penalties, forfeitures, suits and the costs and expenses incident thereto, including costs of defense, settlement, and reasonable attorney's fees, which may be incurred, as a result of death or injuries to any person, or damage to any property, contamination of or adverse effects on the environment, caused in whole or in part by the Customer, its employees, or subcontractors in disposing waste at this Facility. In the event Customer delivers Unacceptable Waste (as determined by Republic) Customer agrees to assume all expenses and obligations with the removal and/or resolution of any effects caused by the delivery of such Unacceptable Waste.

Indemnización. Cliente acuerda indemnizar, mantener inmune, y defender Republic Services, Inc., sus subsidiarios, compañías, divisiones, empleados, oficiales y directores contra de cualquiera y de todas responsabilidades, demandas, penas, pérdidas, juicios, pleitos y los costos incidente además, incluyendo costos de defensa, de acuerdo judicial, y de honorarios razonables del abogado, que pueden ser incurridos en, o como resultado de, la muerte o herida personal a cualquier persona, o daños a cualquier característica, propiedad, contaminación de la tierra o efectos ilícitos en esta Facilidad, causado entero o en parte por el cliente, sus empleados, o sus subcontratistas en botar basura en esta Facilidad. En el caso que el Cliente entrega, bota, basura (según lo determinado por Republic) en este Establecimiento basura inaceptable en los reglamentos de este Establecimiento, el Cliente se compromete asumir todos los costos y obligaciones con el retiro y/o la resolución de cualquier dano(s) causado por la entrega de tal basura inaceptable.



NON-HAZARDOUS WASTE MANIFEST

MANIFEST # 11684

GENERATOR INFORMATION

Generator Name: Tronox LLC
Address: P.O. Box 55
City: Henderson County: Clark
State: NV Zip: 89009
Site Location (if different): 560 W. Lake Mead
Henderson, NV 89015 (702) 592-7727

CUSTOMER/BILLING INFORMATION

Billing Name: NGE LLC c/o Northgate Environment Management
Address: 300 Frank Ogawa Plaza, Ste 510
City: Oakland County: Alameda
State: CA Zip: 94612

Table with 5 columns: Republic Services Approval #, Description of Waste, Volume/Weight, Expiration Date, Container Type. Row 1: 38251011244, Soil for disposal, 33 33/100, 12-31-2011, Tractor with Dump Trailer(s).

*Attach Additional Sheet if necessary

I hereby certify that the above-described materials are non-hazardous wastes as defined by 40 CFR 261 or any applicable state law. Further, that the above named materials are properly classified, described, packaged, marked and labeled, and are in proper condition for transportation according to the applicable regulations of the Department of Transportation.

Susan Crowley
Generator/Authorized Agent Name
Signature
Date Shipped

TRANSPORTER INFORMATION

Transporter Name: Las Vegas Paving DOT # 191949
Address: 4420 S. Decatur Truck Number: 2711
Las Vegas, NV 89103 Phone Number: (702) 353-4355

I certify no hazardous waste or other regulated substance was knowingly introduced to the waste while in my custody. The waste transported in this vehicle is the waste identified above, to the best of my knowledge.

Mike Heffern Mike Heffern
Name of Authorized Agent Signature Date Delivered 10-3-10

DISPOSAL SITE INFORMATION

Site Name: Apex Regional Landfill Phone No. (702) 599-5920
Address: 13550 U.S. Hwy 93 Las Vegas, NV

I hereby acknowledge receipt of the above described materials
Name (Print or Type) Signature Date Received 03 Oct 10

81 Environmental Tech
13550 N Highway 93
Las Vegas, NV 89165

Ticket Type: INBOUND INVOICE

Ticket Number: 1584
Date: 10/03/2010
Time In: 8:40 pm
Time Out: 9:06 pm

Customer: 001011 - NGE, LLC c/o Northgate Environ Mgmt

Vehicle/Container: 43078A
Contract: Northgate Env. On Site Soils 3825 11
Comment: 3825 10 11244

Gross Weight: 121,040 LB Manual In
Tare Weight: 51,360 LB Scale Out
Net Weight: 69680 LB
Net Tons: 34.84

BOL: 11687

Origin	Yards	Material	Billing Quantity
Not Applicable	0.00 YD	SW CONTAMINATED SOIL	34.84 TN

Driver: _____

Weighmaster: _____

HOLDENS

Indemnification. Customer agrees, by signature above, to indemnify, hold harmless, and defend Republic Services, Inc., its subsidiaries, affiliates, employees, officers and directors from and against any and all liabilities, claims, penalties, forfeitures, suits and the costs and expenses incident thereto, including costs of defense, settlement, and reasonable attorney's fees, which may be incurred, as a result of death or injuries to any person, or damage to any property, contamination of or adverse effects on the environment, caused in whole or in part by the Customer, its employees, or subcontractors in disposing waste at this Facility. In the event Customer delivers Unacceptable Waste (as determined by Republic) Customer agrees to assume all expenses and obligations with the removal and/or resolution of any effects caused by the delivery of such Unacceptable Waste.

Indemnización. Cliente acuerda indemnizar, mantener inmune, y defender Republic Services, Inc., sus subsidiarios, compañías, divisiones, empleados, oficiales y directores contra de cualquiera y de todas responsabilidades, demandas, penas, pérdidas, juicios, pleitos y los costos incidente además, incluyendo costos de defensa, de acuerdo judicial, y de honorarios razonables del abogado, que pueden ser incurridos en, o como resultado de, la muerte o herida personal a cualquier persona, o daños a cualquier característica, propiedad, contaminación de la tierra o efectos ilícitos en esta Facilidad, causado entero o en parte por el cliente, sus empleados, o sus subcontratistas en botar basura en esta Facilidad. En el caso que el Cliente entrega, bota, basura (según lo determinado por Republic) en este Establecimiento basura inaceptable en los reglamentos de este Establecimiento, el Cliente se compromete asumir todos los costos y obligaciones con el retiro y/o la resolución de cualquier dano(s) causado por la entrega de tal basura inaceptable.



NON-HAZARDOUS WASTE MANIFEST

MANIFEST # 11687

GENERATOR INFORMATION

Generator Name: Tronox LLC
Address: P.O. Box 55
City: Henderson County: Clark
State: NV Zip: 89009
Site Location (if different): 560 W. Lake Mead
Henderson, NV 89015 (702) 592-7727

CUSTOMER/BILLING INFORMATION

Billing Name: NGE LLC c/o Northgate Environment Management
Address: 300 Frank Ogawa Plaza, Ste 510
City: Oakland County: Alameda
State: CA Zip: 94612

Table with 5 columns: Republic Services Approval #, Description of Waste, Volume/Weight, Expiration Date, Container Type. Row 1: 38251011244, Soil for disposal, 34 3/4 ton, 12-31-2011, Tractor with Dump Trailer(s). Row 2: RZ- #

*Attach Additional Sheet if necessary

I hereby certify that the above-described materials are non-hazardous wastes as defined by 40 CFR 261 or any applicable state law. Further, that the above named materials are properly classified, described, packaged, marked and labeled, and are in proper condition for transportation according to the applicable regulations of the Department of Transportation.

Susan Crowley (Signature)
Generator/Authorized Agent Name Signature Date Shipped

TRANSPORTER INFORMATION

Transporter Name: Las Vegas Paving DOT # 191949
Address: 4420 S. Decatur Truck Number: DWF 200
Las Vegas, NV 89103 Phone Number: (702) 353-4355

I certify no hazardous waste or other regulated substance was knowingly introduced to the waste while in my custody. The waste transported in this vehicle is the waste identified above, to the best of my knowledge.

Dean Froehner (Signature)
Name of Authorized Agent Signature Date Delivered 10-3-10

DISPOSAL SITE INFORMATION

Site Name: Apex Regional Landfill Phone No. (702) 599-5920
Address: 13550 U.S. Hwy 93 Las Vegas, NV

I hereby acknowledge receipt of the above described materials: Holden, Se Derek (Signature)
Name (Print or Type) Signature Date Received 03 Oct 10

81 Environmental Tech
13550 N Highway 93
Las Vegas, NV 89165

Ticket Type: INBOUND INVOICE

Ticket Number: 1585
Date: 10/03/2010
Time In: 8:50 pm
Time Out: 9:18 pm

Customer: 001011 - NGE, LLC c/o Northgate Environ Mgmt

Vehicle/Container: 44166A
Contract: Northgate Env. On Site Soils 3825 11
Comment: 3825 10 11244

Gross Weight: 118,200 LB Manual In
Tare Weight: 57,900 LB Scale Out
Net Weight: 60300 LB
Net Tons: 30.15

BOL: 11688

Origin	Yards	Material	Billing Quantity
Not Applicable	0.00 YD	SW CONTAMINATED SOIL	30.15 TN

Driver:



Weighmaster:

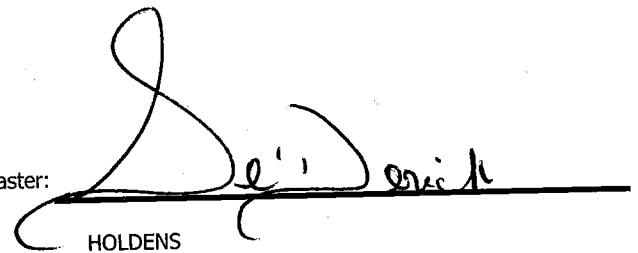

HOLDENS

Indemnification. Customer agrees, by signature above, to indemnify, hold harmless, and defend Republic Services, Inc., its subsidiaries, affiliates, employees, officers and directors from and against any and all liabilities, claims, penalties, forfeitures, suits and the costs and expenses incident thereto, including costs of defense, settlement, and reasonable attorney's fees, which may be incurred, as a result of death or injuries to any person, or damage to any property, contamination of or adverse effects on the environment, caused in whole or in part by the Customer, its employees, or subcontractors in disposing waste at this Facility. In the event Customer delivers Unacceptable Waste (as determined by Republic) Customer agrees to assume all expenses and obligations with the removal and/or resolution of any effects caused by the delivery of such Unacceptable Waste.

Indemnización. Cliente acuerda indemnizar, mantener inmune, y defender Republic Services, Inc., sus subsidiarios, compañías, divisiones, empleados, oficiales y directores contra de cualquiera y de todas responsabilidades, demandas, penas, pérdidas, juicios, pleitos y los costos incidente además, incluyendo costos de defensa, de acuerdo judicial, y de honorarios razonables del abogado, que pueden ser incurridos en, o como resultado de, la muerte o herida personal a cualquier persona, o daños a cualquier característica, propiedad, contaminación de la tierra o efectos ilícitos en esta Facilidad, causado entero o en parte por el cliente, sus empleados, o sus subcontratistas en botar basura en esta Facilidad. En el caso que el Cliente entrega, bota, basura (según lo determinado por Republic) en este Establecimiento basura inaceptable en los reglamentos de este Establecimiento, el Cliente se compromete asumir todos los costos y obligaciones con el retiro y/o la resolución de cualquier dano(s) causado por la entrega de tal basura inaceptable.



NON-HAZARDOUS WASTE MANIFEST

MANIFEST # 11688

GENERATOR INFORMATION

Generator Name: Tronox LLC

Address: P.O. Box 55

City: Henderson County: Clark

State: NV Zip: 89009

Site Location (if different): 560 W. Lake Mead

Henderson, NV 89015 (702) 592-7727

CUSTOMER/BILLING INFORMATION

Billing Name: NGE LLC c/o Northgate Environment Management

Address: 300 Frank Ogawa Plaza, Ste 510

City: Oakland County: Alameda

State: CA Zip: 94612

Table with 5 columns: Republic Services Approval #, Description of Waste, Volume/Weight, Expiration Date, Container Type. Row 1: 38251011244, Soil for disposal, 30 15/100, 12-31-2011, Tractor with Dump Trailer(s).

*Attach Additional Sheet if necessary

I hereby certify that the above-described materials are non-hazardous wastes as defined by 40 CFR 261 or any applicable state law. Further, that the above named materials are properly classified, described, packaged, marked and labeled, and are in proper condition for transportation according to the applicable regulations of the Department of Transportation.

Susan Crowley (Signature) Generator/Authorized Agent Name Signature Date Shipped

TRANSPORTER INFORMATION

Transporter Name: Las Vegas Paving

DOT # 191949

Address: 4420 S. Decatur

Truck Number: K002

Las Vegas, NV 89103

Phone Number: (702) 353-4355

I certify no hazardous waste or other regulated substance was knowingly introduced to the waste while in my custody. The waste transported in this vehicle is the waste identified above, to the best of my knowledge.

(Signature) Name of Authorized Agent Signature Date Delivered 10-3-10

DISPOSAL SITE INFORMATION

Site Name: Apex Regional Landfill

Phone No. (702) 599-5920

Address: 13550 U.S. Hwy 93 Las Vegas, NV

I hereby acknowledge receipt of the above described materials (Signature) Name (Print or Type) Signature Date Received 03 Oct 10

81 Environmental Tech
13550 N Highway 93
Las Vegas, NV 89165

Ticket Type: INBOUND INVOICE

Ticket Number: 1586
Date: 10/03/2010
Time In: 9:03 pm
Time Out: 9:32 pm

Customer: 001011 - NGE, LLC c/o Northgate Environ Mgmt

Vehicle/Container: 44164A
Contract: Northgate Env. On Site Soils 3825 11
Comment: ~~K006~~ 3925 10 11244

Gross Weight: 124,200 LB Manual In
Tare Weight: 50,500 LB Scale Out
Net Weight: 73700 LB
Net Tons: 36.85

BOL: 11689

Origin	Yards	Material	Billing Quantity
Not Applicable	0.00 YD	SW CONTAMINATED SOIL	36.85 TN

Driver:

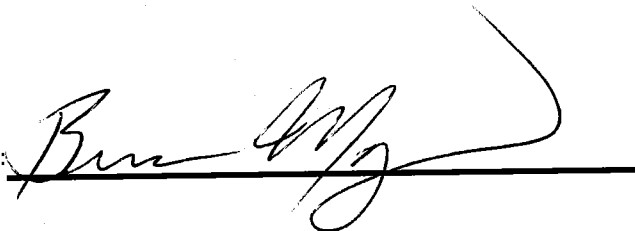

Weighmaster:

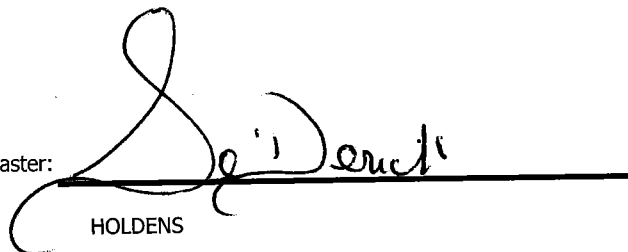

HOLDENS

Indemnification. Customer agrees, by signature above, to indemnify, hold harmless, and defend Republic Services, Inc., its subsidiaries, affiliates, employees, officers and directors from and against any and all liabilities, claims, penalties, forfeitures, suits and the costs and expenses incident thereto, including costs of defense, settlement, and reasonable attorney's fees, which may be incurred, as a result of death or injuries to any person, or damage to any property, contamination of or adverse effects on the environment, caused in whole or in part by the Customer, its employees, or subcontractors in disposing waste at this Facility. In the event Customer delivers Unacceptable Waste (as determined by Republic) Customer agrees to assume all expenses and obligations with the removal and/or resolution of any effects caused by the delivery of such Unacceptable Waste.

Indemnización. Cliente acuerda indemnizar, mantener inmune, y defender Republic Services, Inc., sus subsidiarios, compañías, divisiones, empleados, oficiales y directores contra de cualquiera y de todas responsabilidades, demandas, penas, pérdidas, juicios, pleitos y los costos incidente además, incluyendo costos de defensa, de acuerdo judicial, y de honorarios razonables del abogado, que pueden ser incurridos en, o como resultado de, la muerte o herida personal a cualquier persona, o daños a cualquier característica, propiedad, contaminación de la tierra o efectos ilícitos en esta Facilidad, causado entero o en parte por el cliente, sus empleados, o sus subcontratistas en botar basura en esta Facilidad. En el caso que el Cliente entrega, bota, basura (según lo determinado por Republic) en este Establecimiento basura inaceptable en los reglamentos de este Establecimiento, el Cliente se compromete asumir todos los costos y obligaciones con el retiro y/o la resolución de cualquier dano(s) causado por la entrega de tal basura inaceptable.



NON-HAZARDOUS WASTE MANIFEST

MANIFEST # 11689

GENERATOR INFORMATION

Generator Name: Tronox LLC
Address: P.O. Box 55
City: Henderson County: Clark
State: NV Zip: 89009
Site Location (if different): 560 W. Lake Mead
Henderson, NV 89015 (702) 592-7727

CUSTOMER/BILLING INFORMATION

Billing Name: NGE LLC c/o Northgate Environment Management
Address: 300 Frank Ogawa Plaza, Ste 510
City: Oakland County: Alameda
State: CA Zip: 94612

Table with 5 columns: Republic Services Approval #, Description of Waste, Volume/Weight, Expiration Date, Container Type. Row 1: 38251011244, Soil for disposal, 36 95/70n, 12-31-2011, Tractor with Dump Trailer(s)

*Attach Additional Sheet if necessary

I hereby certify that the above-described materials are non-hazardous wastes as defined by 40 CFR 261 or any applicable state law. Further, that the above named materials are properly classified, described, packaged, marked and labeled, and are in proper condition for transportation according to the applicable regulations of the Department of Transportation.

Susan Crowley
Generator/Authorized Agent Name Signature Date Shipped

TRANSPORTER INFORMATION

Transporter Name: Las Vegas Paving DOT # 191949
Address: 4420 S. Decatur Truck Number: K-006
Las Vegas, NV 89103 Phone Number: (702) 353-4355

I certify no hazardous waste or other regulated substance was knowingly introduced to the waste while in my custody. The waste transported in this vehicle is the waste identified above, to the best of my knowledge.

Brian ... Signature Date Delivered 10-3-10
Name of Authorized Agent Signature Date Delivered

DISPOSAL SITE INFORMATION

Site Name: Apex Regional Landfill Phone No. (702) 599-5920
Address: 13550 U.S. Hwy 93 Las Vegas, NV

I hereby acknowledge receipt of the above described materials
Holden, Se' Derick Signature Date Received 03 Oct 10
Name (Print or Type) Signature Date Received

81 Environmental Tech
13550 N Highway 93
Las Vegas, NV 89165

Ticket Type: INBOUND INVOICE

Ticket Number: 1587
Date: 10/03/2010
Time In: 9:07 pm
Time Out: 9:33 pm

Customer: 001011 - NGE, LLC c/o Northgate Environ Mgmt

Vehicle/Container: 82290P
Contract: Northgate Env. On Site Soils 3825 11
Comment: ~~ITB~~ → 3825 10 11 244

Gross Weight: 125,640 LB Manual In
Tare Weight: 54,760 LB Manual Out
Net Weight: 70880 LB
Net Tons: 35.44

BOL: 11690

Origin	Yards	Material	Billing Quantity
Not Applicable	0.00 YD	SW CONTAMINATED SOIL	35.44 TN

Driver: _____

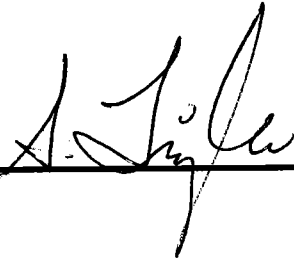

Weighmaster: _____

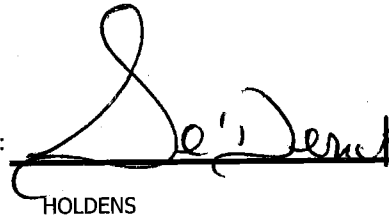
HOLDENS

Indemnification. Customer agrees, by signature above, to indemnify, hold harmless, and defend Republic Services, Inc., its subsidiaries, affiliates, employees, officers and directors from and against any and all liabilities, claims, penalties, forfeitures, suits and the costs and expenses incident thereto, including costs of defense, settlement, and reasonable attorney's fees, which may be incurred, as a result of death or injuries to any person, or damage to any property, contamination of or adverse effects on the environment, caused in whole or in part by the Customer, its employees, or subcontractors in disposing waste at this Facility. In the event Customer delivers Unacceptable Waste (as determined by Republic) Customer agrees to assume all expenses and obligations with the removal and/or resolution of any effects caused by the delivery of such Unacceptable Waste.

Indemnización. Cliente acuerda indemnizar, mantener inmune, y defender Republic Services, Inc., sus subsidiarios, compañías, divisiones, empleados, oficiales y directores contra de cualquiera y de todas responsabilidades, demandas, penas, pérdidas, juicios, pleitos y los costos incidente además, incluyendo costos de defensa, de acuerdo judicial, y de honorarios razonables del abogado, que pueden ser incurridos en, o como resultado de, la muerte o herida personal a cualquier persona, o daños a cualquier característica, propiedad, contaminación de la tierra o efectos ilícitos en esta Facilidad, causado entero o en parte por el cliente, sus empleados, o sus subcontratistas en botar basura en esta Facilidad. En el caso que el Cliente entrega, bota, basura (según lo determinado por Republic) en este Establecimiento basura inaceptable en los reglamentos de este Establecimiento, el Cliente se compromete asumir todos los costos y obligaciones con el retiro y/o la resolución de cualquier dano(s) causado por la entrega de tal basura inaceptable.



NON-HAZARDOUS WASTE MANIFEST

MANIFEST # 11690

GENERATOR INFORMATION

Generator Name: Tronox LLC

Address: P.O. Box 55

City: Henderson County: Clark

State: NV Zip: 89009

Site Location (if different): 560 W. Lake Mead

Henderson, NV 89015 (702) 592-7727

CUSTOMER/BILLING INFORMATION

Billing Name: NGE LLC c/o Northgate Environment Management

Address: 300 Frank Ogawa Plaza, Ste 510

City: Oakland County: Alameda

State: CA Zip: 94612

Republic Services Approval #	Description of Waste	Volume/Weight	Expiration Date	Container Type
38251011244	Soil for disposal	35 ⁴⁴ / ₁₀₀	12-31-2011	Tractor with Dump Trailer(s)
	RZ- _____ # _____			

*Attach Additional Sheet if necessary

I hereby certify that the above-described materials are non-hazardous wastes as defined by 40 CFR 261 or any applicable state law. Further, that the above named materials are properly classified, described, packaged, marked and labeled, and are in proper condition for transportation according to the applicable regulations of the Department of Transportation.

Susan Crowley
Generator/Authorized Agent Name

Susan Crowley
Signature

Date Shipped

TRANSPORTER INFORMATION

Transporter Name: Las Vegas Paving

DOT # 191949

Address: 4420 S. Decatur

Truck Number: 06

Las Vegas, NV 89103

Phone Number: (702) 353-4355

I certify no hazardous waste or other regulated substance was knowingly introduced to the waste while in my custody. The waste transported in this vehicle is the waste identified above, to the best of my knowledge.

TRUCKER, STEVE
Name of Authorized Agent

[Signature]
Signature

10.3.10
Date Delivered

DISPOSAL SITE INFORMATION

Site Name: Apex Regional Landfill

Phone No. (702) 599-5920

Address: 13550 U.S. Hwy 93 Las Vegas, NV

I hereby acknowledge receipt of the above described materials

Holden, Se Derrick
Name (Print or Type)

[Signature]
Signature

03 Oct 10
Date Received

81 Environmental Tech
13550 N Highway 93
Las Vegas, NV 89165

Ticket Type: INBOUND INVOICE

Ticket Number: 1588
Date: 10/03/2010
Time In: 9:17 pm
Time Out: 9:43 pm

Customer: 001011 - NGE, LLC c/o Northgate Environ Mgmt

Vehicle/Container: 44564A
Contract: Northgate Env. On Site Soils 3825 11
Comment: 3825 10 11244

Gross Weight: 130,960 LB Manual In
Tare Weight: 49,300 LB Scale Out
Net Weight: 81660 LB
Net Tons: 40.83

BOL: 11691

Origin	Yards	Material	Billing Quantity
Not Applicable	0.00 YD	SW CONTAMINATED SOIL	40.83 TN

Driver: _____

Weighmaster: _____

HOLDENS

Indemnification. Customer agrees, by signature above, to indemnify, hold harmless, and defend Republic Services, Inc., its subsidiaries, affiliates, employees, officers and directors from and against any and all liabilities, claims, penalties, forfeitures, suits and the costs and expenses incident thereto, including costs of defense, settlement, and reasonable attorney's fees, which may be incurred, as a result of death or injuries to any person, or damage to any property, contamination of or adverse effects on the environment, caused in whole or in part by the Customer, its employees, or subcontractors in disposing waste at this Facility. In the event Customer delivers Unacceptable Waste (as determined by Republic) Customer agrees to assume all expenses and obligations with the removal and/or resolution of any effects caused by the delivery of such Unacceptable Waste.

Indemnización. Cliente acuerda indemnizar, mantener inmune, y defender Republic Services, Inc., sus subsidiarios, compañías, divisiones, empleados, oficiales y directores contra de cualquiera y de todas responsabilidades, demandas, penas, pérdidas, juicios, pleitos y los costos incidente además, incluyendo costos de defensa, de acuerdo judicial, y de honorarios razonables del abogado, que pueden ser incurridos en, o como resultado de, la muerte o herida personal a cualquier persona, o daños a cualquier característica, propiedad, contaminación de la tierra o efectos ilícitos en esta Facilidad, causado entero o en parte por el cliente, sus empleados, o sus subcontratistas en botar basura en esta Facilidad. En el caso que el Cliente entrega, bota, basura (según lo determinado por Republic) en este Establecimiento basura inaceptable en los reglamentos de este Establecimiento, el Cliente se compromete asumir todos los costos y obligaciones con el retiro y/o la resolución de cualquier dano(s) causado por la entrega de tal basura inaceptable.



NON-HAZARDOUS WASTE MANIFEST

MANIFEST # 11691

GENERATOR INFORMATION

Generator Name: Tronox LLC

Address: P.O. Box 55

City: Henderson County: Clark

State: NV Zip: 89009

Site Location (if different): 560 W. Lake Mead

Henderson, NV 89015 (702) 592-7727

CUSTOMER/BILLING INFORMATION

Billing Name: NGE LLC c/o Northgate Environment Management

Address: 300 Frank Ogawa Plaza, Ste 510

City: Oakland County: Alameda

State: CA Zip: 94612

Republic Services Approval #	Description of Waste	Volume/Weight	Expiration Date	Container Type
38251011244	Soil for disposal	40 ⁸³ / ₁₀₁	12-31-2011	Tractor with Dump Trailer(s)
	RZ- _____ # _____			

*Attach Additional Sheet if necessary

I hereby certify that the above-described materials are non-hazardous wastes as defined by 40 CFR 261 or any applicable state law. Further, that the above named materials are properly classified, described, packaged, marked and labeled, and are in proper condition for transportation according to the applicable regulations of the Department of Transportation.

Susan Crowley [Signature] _____
 Generator/Authorized Agent Name Signature Date Shipped

TRANSPORTER INFORMATION

Transporter Name: Las Vegas Paving

DOT # 191949

Address: 4420 S. Decatur

Truck Number: 4023

Las Vegas, NV 89103

Phone Number: (702) 353-4355

I certify no hazardous waste or other regulated substance was knowingly introduced to the waste while in my custody. The waste transported in this vehicle is the waste identified above, to the best of my knowledge.

ASCACION [Signature] 10/03/10
 Name of Authorized Agent Signature Date Delivered

DISPOSAL SITE INFORMATION

Site Name: Apex Regional Landfill

Phone No. (702) 599-5920

Address: 13550 U.S. Hwy 93 Las Vegas, NV

I hereby acknowledge receipt of the above described materials

Holden, Se [Signature] 03 Oct 10
 Name (Print or Type) Signature Date Received

81 Environmental Tech
13550 N Highway 93
Las Vegas, NV 89165

Ticket Type: INBOUND INVOICE

Ticket Number: 1589
Date: 10/03/2010
Time In: 9:41 pm
Time Out: 10:20 pm

Customer: 001011 - NGE, LLC c/o Northgate Environ Mgmt

Vehicle/Container: 44165A
Contract: Northgate Env. On Site Soils 3825 11
Comment: 3825 10 11244

Gross Weight: 122,040 LB Manual In
Tare Weight: 49,700 LB Scale Out
Net Weight: 72340 LB
Net Tons: 36.17

BOL: 11680

Origin	Yards	Material	Billing Quantity
Not Applicable	0.00 YD	SW CONTAMINATED SOIL	36.17 TN

Driver:



Weighmaster:

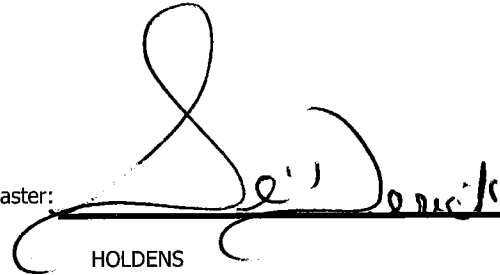

HOLDENS

Indemnification. Customer agrees, by signature above, to indemnify, hold harmless, and defend Republic Services, Inc., its subsidiaries, affiliates, employees, officers and directors from and against any and all liabilities, claims, penalties, forfeitures, suits and the costs and expenses incident thereto, including costs of defense, settlement, and reasonable attorney's fees, which may be incurred, as a result of death or injuries to any person, or damage to any property, contamination of or adverse effects on the environment, caused in whole or in part by the Customer, its employees, or subcontractors in disposing waste at this Facility. In the event Customer delivers Unacceptable Waste (as determined by Republic) Customer agrees to assume all expenses and obligations with the removal and/or resolution of any effects caused by the delivery of such Unacceptable Waste.

Indemnización. Cliente acuerda indemnizar, mantener inmune, y defender Republic Services, Inc., sus subsidiarios, compañías, divisiones, empleados, oficiales y directores contra de cualquiera y de todas responsabilidades, demandas, penas, pérdidas, juicios, pleitos y los costos incidente además, incluyendo costos de defensa, de acuerdo judicial, y de honorarios razonables del abogado, que pueden ser incurridos en, o como resultado de, la muerte o herida personal a cualquier persona, o daños a cualquier característica, propiedad, contaminación de la tierra o efectos ilícitos en esta Facilidad, causado entero o en parte por el cliente, sus empleados, o sus subcontratistas en botar basura en esta Facilidad. En el caso que el Cliente entrega, bota, basura (según lo determinado por Republic) en este Establecimiento basura inaceptable en los reglamentos de este Establecimiento, el Cliente se compromete asumir todos los costos y obligaciones con el retiro y/o la resolución de cualquier dano(s) causado por la entrega de tal basura inaceptable.



NON-HAZARDOUS WASTE MANIFEST

MANIFEST # 11680

GENERATOR INFORMATION

Generator Name: Tronox LLC

Address: P.O. Box 55

City: Henderson County: Clark

State: NV Zip: 89009

Site Location (if different): 560 W. Lake Mead

Henderson, NV 89015 (702) 592-7727

CUSTOMER/BILLING INFORMATION

Billing Name: NGE LLC c/o Northgate Environment Management

Address: 300 Frank Ogawa Plaza, Ste 510

City: Oakland County: Alameda

State: CA Zip: 94612

Republic Services Approval #	Description of Waste	Volume/Weight	Expiration Date	Container Type
38251011244	Soil for disposal	36 ¹³ / _{ton}	12-31-2011	Tractor with Dump Trailer(s)
	RZ- _____ # _____			

*Attach Additional Sheet if necessary

I hereby certify that the above-described materials are non-hazardous wastes as defined by 40 CFR 261 or any applicable state law. Further, that the above named materials are properly classified, described, packaged, marked and labeled, and are in proper condition for transportation according to the applicable regulations of the Department of Transportation.

Susan Crowley
Generator/Authorized Agent Name

Susan Crowley
Signature

Date Shipped

TRANSPORTER INFORMATION

Transporter Name: Las Vegas Paving

DOT # 191949

Address: 4420 S. Decatur

Truck Number: K001

Las Vegas, NV 89103

Phone Number: (702) 353-4355

I certify no hazardous waste or other regulated substance was knowingly introduced to the waste while in my custody. The waste transported in this vehicle is the waste identified above, to the best of my knowledge.

Rama
Name of Authorized Agent

Rama
Signature

10-3-10
Date Delivered

DISPOSAL SITE INFORMATION

Site Name: Apex Regional Landfill

Phone No. (702) 599-5920

Address: 13550 U.S. Hwy 93 Las Vegas, NV

I hereby acknowledge receipt of the above described materials

Holden, Se... ck
Name (Print or Type)

Se... Holden
Signature

03 Oct 10
Date Received

81 Environmental Tech
13550 N Highway 93
Las Vegas, NV 89165

Ticket Type: INBOUND INVOICE

Ticket Number: 1590
Date: 10/03/2010
Time In: 10:00 pm
Time Out: 10:25 pm

Customer: 001011 - NGE, LLC c/o Northgate Environ Mgmt

Vehicle/Container: 20915A

Contract: Northgate Env. On Site Soils 3825 11
Comment: ~~00-3825~~ 10 11244

Gross Weight: 126,240 LB Manual In
Tare Weight: 53,260 LB Scale Out
Net Weight: 72980 LB
Net Tons: 36.49

BOL: 11695

Origin	Yards	Material	Billing Quantity
Not Applicable	0.00 YD	SW CONTAMINATED SOIL	36.49 TN

Driver:

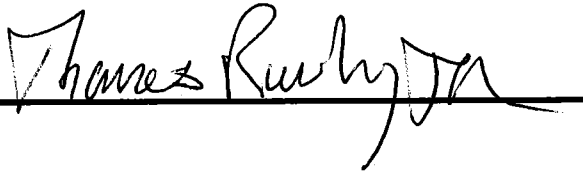

Weighmaster:

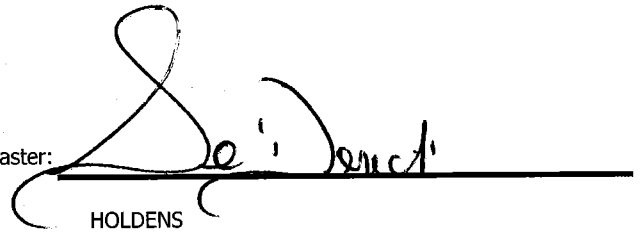

HOLDENS

Indemnification. Customer agrees, by signature above, to indemnify, hold harmless, and defend Republic Services, Inc., its subsidiaries, affiliates, employees, officers and directors from and against any and all liabilities, claims, penalties, forfeitures, suits and the costs and expenses incident thereto, including costs of defense, settlement, and reasonable attorney's fees, which may be incurred, as a result of death or injuries to any person, or damage to any property, contamination of or adverse effects on the environment, caused in whole or in part by the Customer, its employees, or subcontractors in disposing waste at this Facility. In the event Customer delivers Unacceptable Waste (as determined by Republic) Customer agrees to assume all expenses and obligations with the removal and/or resolution of any effects caused by the delivery of such Unacceptable Waste.

Indemnización. Cliente acuerda indemnizar, mantener inmune, y defender Republic Services, Inc., sus subsidiarios, compañías, divisiones, empleados, oficiales y directores contra de cualquiera y de todas responsabilidades, demandas, penas, pérdidas, juicios, pleitos y los costos incidente además, incluyendo costos de defensa, de acuerdo judicial, y de honorarios razonables del abogado, que pueden ser incurridos en, o como resultado de, la muerte o herida personal a cualquier persona, o daños a cualquier característica, propiedad, contaminación de la tierra o efectos ilícitos en esta Facilidad, causado entero o en parte por el cliente, sus empleados, o sus subcontratistas en botar basura en esta Facilidad. En el caso que el Cliente entrega, bota, basura (según lo determinado por Republic) en este Establecimiento basura inaceptable en los reglamentos de este Establecimiento, el Cliente se compromete asumir todos los costos y obligaciones con el retiro y/o la resolución de cualquier dano(s) causado por la entrega de tal basura inaceptable.



NON-HAZARDOUS WASTE MANIFEST

MANIFEST # 11695

GENERATOR INFORMATION

Generator Name: Tronox LLC

Address: P.O. Box 55

City: Henderson County: Clark

State: NV Zip: 89009

Site Location (if different): 560 W. Lake Mead

Henderson, NV 89015 (702) 592-7727

CUSTOMER/BILLING INFORMATION

Billing Name: NGE LLC c/o Northgate Environment Management

Address: 300 Frank Ogawa Plaza, Ste 510

City: Oakland County: Alameda

State: CA Zip: 94612

Republic Services Approval #	Description of Waste	Volume/Weight	Expiration Date	Container Type
38251011244	Soil for disposal	36 ⁴⁹ / _{lb}	12-31-2011	Tractor with Dump Trailer(s)
	RZ- _____ # _____			

*Attach Additional Sheet if necessary

I hereby certify that the above-described materials are non-hazardous wastes as defined by 40 CFR 261 or any applicable state law. Further, that the above named materials are properly classified, described, packaged, marked and labeled, and are in proper condition for transportation according to the applicable regulations of the Department of Transportation.

Susan Crowley (Signature)
Generator/Authorized Agent Name Signature Date Shipped

TRANSPORTER INFORMATION

Transporter Name: Las Vegas Paving

DOT # 191949

Address: 4420 S. Decatur

Truck Number: 00

Las Vegas, NV 89103

Phone Number: (702) 353-4355

I certify no hazardous waste or other regulated substance was knowingly introduced to the waste while in my custody. The waste transported in this vehicle is the waste identified above, to the best of my knowledge.

Tom Raulo (Signature)
Name of Authorized Agent Signature Date Delivered 10-3-10

DISPOSAL SITE INFORMATION

Site Name: Apex Regional Landfill

Phone No. (702) 599-5920

Address: 13550 U.S. Hwy 93 Las Vegas, NV

I hereby acknowledge receipt of the above described materials
Holden, Se' Derrick (Signature)
Name (Print or Type) Signature Date Received 03 Oct 10

81 Environmental Tech
13550 N Highway 93
Las Vegas, NV 89165

Ticket Type: INBOUND INVOICE

Ticket Number: 1591
Date: 10/03/2010
Time In: 10:05 pm
Time Out: 10:28 pm

Customer: 001011 - NGE, LLC c/o Northgate Environ Mgmt

Vehicle/Container: 81494P
Contract: Northgate Env. On Site Soils 3825 11
Comment: 3825 10 11244

Gross Weight: 121,180 LB Manual In
Tare Weight: 51,080 LB Manual Out
Net Weight: 70100 LB
Net Tons: 35.05

BOL: 11696

Origin	Yards	Material	Billing Quantity
Not Applicable	0.00 YD	SW CONTAMINATED SOIL	35.05 TN

Driver: _____



Weighmaster: _____

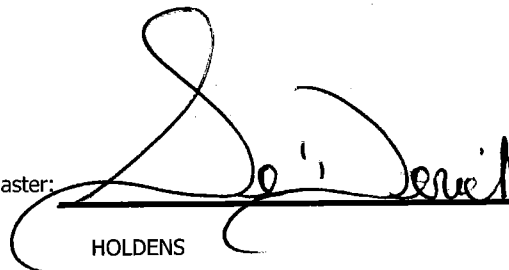

HOLDENS

Indemnification. Customer agrees, by signature above, to indemnify, hold harmless, and defend Republic Services, Inc., its subsidiaries, affiliates, employees, officers and directors from and against any and all liabilities, claims, penalties, forfeitures, suits and the costs and expenses incident thereto, including costs of defense, settlement, and reasonable attorney's fees, which may be incurred, as a result of death or injuries to any person, or damage to any property, contamination of or adverse effects on the environment, caused in whole or in part by the Customer, its employees, or subcontractors in disposing waste at this Facility. In the event Customer delivers Unacceptable Waste (as determined by Republic) Customer agrees to assume all expenses and obligations with the removal and/or resolution of any effects caused by the delivery of such Unacceptable Waste.

Indemnización. Cliente acuerda indemnizar, mantener inmune, y defender Republic Services, Inc., sus subsidiarios, compañías, divisiones, empleados, oficiales y directores contra de cualquiera y de todas responsabilidades, demandas, penas, pérdidas, juicios, pleitos y los costos incidente además, incluyendo costos de defensa, de acuerdo judicial, y de honorarios razonables del abogado, que pueden ser incurridos en, o como resultado de, la muerte o herida personal a cualquier persona, o daños a cualquier característica, propiedad, contaminación de la tierra o efectos ilícitos en esta Facilidad, causado entero o en parte por el cliente, sus empleados, o sus subcontratistas en botar basura en esta Facilidad. En el caso que el Cliente entrega, bota, basura (según lo determinado por Republic) en este Establecimiento basura inaceptable en los reglamentos de este Establecimiento, el Cliente se compromete asumir todos los costos y obligaciones con el retiro y/o la resolución de cualquier dano(s) causado por la entrega de tal basura inaceptable.



NON-HAZARDOUS WASTE MANIFEST

MANIFEST # 11696

GENERATOR INFORMATION

Generator Name: Tronox LLC

Address: P.O. Box 55

City: Henderson County: Clark

State: NV Zip: 89009

Site Location (if different): 560 W. Lake Mead
Henderson, NV 89015 (702) 592-7727

CUSTOMER/BILLING INFORMATION

Billing Name: NGE LLC c/o Northgate Environment Management

Address: 300 Frank Ogawa Plaza, Ste 510

City: Oakland County: Alameda

State: CA Zip: 94612

Table with 5 columns: Republic Services Approval #, Description of Waste, Volume/Weight, Expiration Date, Container Type. Row 1: 38251011244, Soil for disposal, 35 00/ton, 12-31-2011, Tractor with Dump Trailer(s). Row 2: RZ- #

*Attach Additional Sheet if necessary.

I hereby certify that the above-described materials are non-hazardous wastes as defined by 40 CFR 261 or any applicable state law. Further, that the above named materials are properly classified, described, packaged, marked and labeled, and are in proper condition for transportation according to the applicable regulations of the Department of Transportation.

Susan Crowley (Signature)
Generator/Authorized Agent Name Signature Date Shipped

TRANSPORTER INFORMATION

Transporter Name: Las Vegas Paving

DOT # 191949

Address: 4420 S. Decatur

Truck Number: 125

Las Vegas, NV 89103

Phone Number: (702) 353-4355

I certify no hazardous waste or other regulated substance was knowingly introduced to the waste while in my custody. The waste transported in this vehicle is the waste identified above, to the best of my knowledge.

Calvin Paguyo (Signature)
Name of Authorized Agent Signature Date Delivered 10/03/10

DISPOSAL SITE INFORMATION

Site Name: Apex Regional Landfill

Phone No. (702) 599-5920

Address: 13550 U.S. Hwy 93 Las Vegas, NV

I hereby acknowledge receipt of the above described materials
Helen Se'Jercell (Signature)
Name (Print or Type) Signature Date Received 03 Oct 10

81 Environmental Tech
13550 N Highway 93
Las Vegas, NV 89165

Ticket Type: INBOUND INVOICE

Ticket Number: 1592
Date: 10/03/2010
Time In: 10:07 pm
Time Out: 10:29 pm

Customer: 001011 - NGE, LLC c/o Northgate Environ Mgmt

Vehicle/Container: 81495P
Contract: Northgate Env. On Site Soils 3825 11
Comment: 3825 10 11244

Gross Weight: 126,520 LB Manual In
Tare Weight: 50,360 LB Manual Out
Net Weight: 76160 LB
Net Tons: 38.08

BOL: 11697

Origin	Yards	Material	Billing	Quantity
Not Applicable	0.00 YD	SW CONTAMINATED SOIL	38.08	TN

Driver: _____

Weighmaster: _____

HOLDENS

Indemnification. Customer agrees, by signature above, to indemnify, hold harmless, and defend Republic Services, Inc., its subsidiaries, affiliates, employees, officers and directors from and against any and all liabilities, claims, penalties, forfeitures, suits and the costs and expenses incident thereto, including costs of defense, settlement, and reasonable attorney's fees, which may be incurred, as a result of death or injuries to any person, or damage to any property, contamination of or adverse effects on the environment, caused in whole or in part by the Customer, its employees, or subcontractors in disposing waste at this Facility. In the event Customer delivers Unacceptable Waste (as determined by Republic) Customer agrees to assume all expenses and obligations with the removal and/or resolution of any effects caused by the delivery of such Unacceptable Waste.

Indemnización. Cliente acuerda indemnizar, mantener inmune, y defender Republic Services, Inc., sus subsidiarios, compañías, divisiones, empleados, oficiales y directores contra de cualquiera y de todas responsabilidades, demandas, penas, pérdidas, juicios, pleitos y los costos incidente además, incluyendo costos de defensa, de acuerdo judicial, y de honorarios razonables del abogado, que pueden ser incurridos en, o como resultado de, la muerte o herida personal a cualquier persona, o daños a cualquier característica, propiedad, contaminación de la tierra o efectos ilícitos en esta Facilidad, causado entero o en parte por el cliente, sus empleados, o sus subcontratistas en botar basura en esta Facilidad. En el caso que el Cliente entrega, bota, basura (según lo determinado por Republic) en este Establecimiento basura inaceptable en los reglamentos de este Establecimiento, el Cliente se compromete asumir todos los costos y obligaciones con el retiro y/o la resolución de cualquier dano(s) causado por la entrega de tal basura inaceptable.



NON-HAZARDOUS WASTE MANIFEST

MANIFEST # 11697

GENERATOR INFORMATION

Generator Name: Tronox LLC

Address: P.O. Box 55

City: Henderson County: Clark

State: NV Zip: 89009

Site Location (if different): 560 W. Lake Mead

Henderson, NV 89015 (702) 592-7727

CUSTOMER/BILLING INFORMATION

Billing Name: NGE LLC c/o Northgate Environment Management

Address: 300 Frank Ogawa Plaza, Ste 510

City: Oakland County: Alameda

State: CA Zip: 94612

Republic Services Approval #	Description of Waste	Volume/Weight	Expiration Date	Container Type
38251011244	Soil for disposal	30 ⁰⁸ / ₁₀ Ton	12-31-2011	Tractor with Dump Trailer(s)
	RZ- _____ # _____			

*Attach Additional Sheet if necessary

I hereby certify that the above-described materials are non-hazardous wastes as defined by 40 CFR 261 or any applicable state law. Further, that the above named materials are properly classified, described, packaged, marked and labeled, and are in proper condition for transportation according to the applicable regulations of the Department of Transportation.

Susan Crowley

Generator/Authorized Agent Name

Signature

Date Shipped

TRANSPORTER INFORMATION

Transporter Name: Las Vegas Paving

DOT # 191949

Address: 4420 S. Decatur

Truck Number: 175

Las Vegas, NV 89103

Phone Number: (702) 353-4355

I certify no hazardous waste or other regulated substance was knowingly introduced to the waste while in my custody. The waste transported in this vehicle is the waste identified above, to the best of my knowledge.

Andrew Walker

10/3/10

Name of Authorized Agent

Signature

Date Delivered

DISPOSAL SITE INFORMATION

Site Name: Apex Regional Landfill

Phone No. (702) 599-5920

Address: 13550 U.S. Hwy 93 Las Vegas, NV

I hereby acknowledge receipt of the above described materials

Holden, Sojer

03 Oct 10

Name (Print or Type)

Signature

Date Received

81 Environmental Tech
13550 N Highway 93
Las Vegas, NV 89165

Ticket Type: INBOUND INVOICE

Ticket Number: 1593
Date: 10/03/2010
Time In: 10:09 pm
Time Out: 10:31 pm

Customer: 001011 - NGE, LLC c/o Northgate Environ Mgmt

Vehicle/Container: 43099A
Contract: Northgate Env. On Site Soils 3825 11
Comment: 3825 10 11244

Gross Weight: 130,220 LB Manual In
Tare Weight: 58,840 LB Manual Out
Net Weight: 71380 LB
Net Tons: 35.69

BOL: 11698

Origin	Yards	Material	Billing Quantity
Not Applicable	0.00 YD	SW CONTAMINATED SOIL	35.69 TN

Driver: _____

Weighmaster: _____

HOLDENS

Indemnification. Customer agrees, by signature above, to indemnify, hold harmless, and defend Republic Services, Inc., its subsidiaries, affiliates, employees, officers and directors from and against any and all liabilities, claims, penalties, forfeitures, suits and the costs and expenses incident thereto, including costs of defense, settlement, and reasonable attorney's fees, which may be incurred, as a result of death or injuries to any person, or damage to any property, contamination of or adverse effects on the environment, caused in whole or in part by the Customer, its employees, or subcontractors in disposing waste at this Facility. In the event Customer delivers Unacceptable Waste (as determined by Republic) Customer agrees to assume all expenses and obligations with the removal and/or resolution of any effects caused by the delivery of such Unacceptable Waste.

Indemnización. Cliente acuerda indemnizar, mantener inmune, y defender Republic Services, Inc., sus subsidiarios, compañías, divisiones, empleados, oficiales y directores contra de cualquiera y de todas responsabilidades, demandas, penas, pérdidas, juicios, pleitos y los costos incidente además, incluyendo costos de defensa, de acuerdo judicial, y de honorarios razonables del abogado, que pueden ser incurridos en, o como resultado de, la muerte o herida personal a cualquier persona, o daños a cualquier característica, propiedad, contaminación de la tierra o efectos ilícitos en esta Facilidad, causado entero o en parte por el cliente, sus empleados, o sus subcontratistas en botar basura en esta Facilidad. En el caso que el Cliente entrega, bota, basura (según lo determinado por Republic) en este Establecimiento basura inaceptable en los reglamentos de este Establecimiento, el Cliente se compromete asumir todos los costos y obligaciones con el retiro y/o la resolución de cualquier dano(s) causado por la entrega de tal basura inaceptable.



NON-HAZARDOUS WASTE MANIFEST

MANIFEST # 11698

GENERATOR INFORMATION

Generator Name: Tronox LLC
Address: P.O. Box 55
City: Henderson County: Clark
State: NV Zip: 89009
Site Location (if different): 560 W. Lake Mead
Henderson, NV 89015 (702) 592-7727

CUSTOMER/BILLING INFORMATION

Billing Name: NGE LLC c/o Northgate Environment Management
Address: 300 Frank Ogawa Plaza, Ste 510
City: Oakland County: Alameda
State: CA Zip: 94612

Table with 5 columns: Republic Services Approval #, Description of Waste, Volume/Weight, Expiration Date, Container Type. Row 1: 38251011244, Soil for disposal, 35.69/100, 12-31-2011, Tractor with Dump Trailer(s).

*Attach Additional Sheet if necessary

I hereby certify that the above-described materials are non-hazardous wastes as defined by 40 CFR 261 or any applicable state law. Further, that the above named materials are properly classified, described, packaged, marked and labeled, and are in proper condition for transportation according to the applicable regulations of the Department of Transportation.

Susan Crowley
Generator/Authorized Agent Name Signature Date Shipped

TRANSPORTER INFORMATION

Transporter Name: Las Vegas Paving DOT # 191949
Address: 4420 S. Decatur Truck Number: Berlock #6
Las Vegas, NV 89103 Phone Number: (702) 353-4355

I certify no hazardous waste or other regulated substance was knowingly introduced to the waste while in my custody. The waste transported in this vehicle is the waste identified above, to the best of my knowledge.

James Lawrence
Name of Authorized Agent Signature Date Delivered 10/3/10

DISPOSAL SITE INFORMATION

Site Name: Apex Regional Landfill Phone No. (702) 599-5920
Address: 13550 U.S. Hwy 93 Las Vegas, NV

I hereby acknowledge receipt of the above described materials

Holden, Se'Jerrick
Name (Print or Type) Signature Date Received 03 Oct 10

81 Environmental Tech
13550 N Highway 93
Las Vegas, NV 89165

Ticket Type: INBOUND INVOICE

Ticket Number: 1594
Date: 10/03/2010
Time In: 10:14 pm
Time Out: 10:35 pm

Customer: 001011 - NGE, LLC c/o Northgate Environ Mgmt

Vehicle/Container: 81496P
Contract: Northgate Env. On Site Soils 3825 11
Comment: 3825 10 11244

Gross Weight: 120,160 LB Manual In
Tare Weight: 50,260 LB Manual Out
Net Weight: 69900 LB
Net Tons: 34.95

BOL: 11699

Origin	Yards	Material	Billing Quantity
Not Applicable	0.00 YD	SW CONTAMINATED SOIL	34.95 TN

Driver:

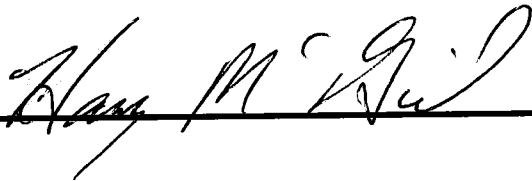

Weighmaster:

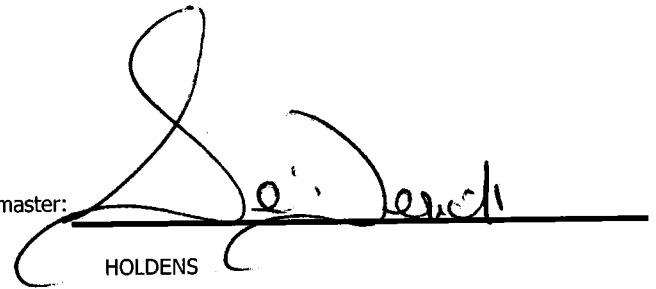

HOLDENS

Indemnification. Customer agrees, by signature above, to indemnify, hold harmless, and defend Republic Services, Inc., its subsidiaries, affiliates, employees, officers and directors from and against any and all liabilities, claims, penalties, forfeitures, suits and the costs and expenses incident thereto, including costs of defense, settlement, and reasonable attorney's fees, which may be incurred, as a result of death or injuries to any person, or damage to any property, contamination of or adverse effects on the environment, caused in whole or in part by the Customer, its employees, or subcontractors in disposing waste at this Facility. In the event Customer delivers Unacceptable Waste (as determined by Republic) Customer agrees to assume all expenses and obligations with the removal and/or resolution of any effects caused by the delivery of such Unacceptable Waste.

Indemnización. Cliente acuerda indemnizar, mantener inmune, y defender Republic Services, Inc., sus subsidiarios, compañías, divisiones, empleados, oficiales y directores contra de cualquiera y de todas responsabilidades, demandas, penas, pérdidas, juicios, pleitos y los costos incidente además, incluyendo costos de defensa, de acuerdo judicial, y de honorarios razonables del abogado, que pueden ser incurridos en, o como resultado de, la muerte o herida personal a cualquier persona, o daños a cualquier característica, propiedad, contaminación de la tierra o efectos ilícitos en esta Facilidad, causado entero o en parte por el cliente, sus empleados, o sus subcontratistas en botar basura en esta Facilidad. En el caso que el Cliente entrega, bota, basura (según lo determinado por Republic) en este Establecimiento basura inaceptable en los reglamentos de este Establecimiento, el Cliente se compromete asumir todos los costos y obligaciones con el retiro y/o la resolución de cualquier dano(s) causado por la entrega de tal basura inaceptable.



NON-HAZARDOUS WASTE MANIFEST

MANIFEST # 11699

GENERATOR INFORMATION

Generator Name: Tronox LLCAddress: P.O. Box 55City: Henderson County: ClarkState: NV Zip: 89009Site Location (if different): 560 W. Lake MeadHenderson, NV 89015 (702) 592-7727

CUSTOMER/BILLING INFORMATION

Billing Name: NGE LLC c/o Northgate Environment ManagementAddress: 300 Frank Ogawa Plaza, Ste 510City: Oakland County: AlamedaState: CA Zip: 94612

Republic Services Approval #	Description of Waste	Volume/Weight	Expiration Date	Container Type
38251011244	Soil for disposal	34 ⁹⁵ / ₁₀₀	12-31-2011	Tractor with Dump Trailer(s)
	RZ- _____ # _____			

*Attach Additional Sheet if necessary

I hereby certify that the above-described materials are non-hazardous wastes as defined by 40 CFR 261 or any applicable state law. Further, that the above named materials are properly classified, described, packaged, marked and labeled, and are in proper condition for transportation according to the applicable regulations of the Department of Transportation.

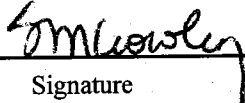
Susan Crowley 
 Generator/Authorized Agent Name Signature Date Shipped

TRANSPORTER INFORMATION

Transporter Name: Las Vegas PavingDOT # 191949Address: 4420 S. DecaturTruck Number: 145Las Vegas, NV 89103Phone Number: (702) 353-4355

I certify no hazardous waste or other regulated substance was knowingly introduced to the waste while in my custody. The waste transported in this vehicle is the waste identified above, to the best of my knowledge.

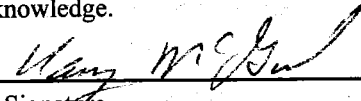
Harry McEal 
 Name of Authorized Agent Signature Date Delivered 10-3-10

DISPOSAL SITE INFORMATION

Site Name: Apex Regional LandfillPhone No. (702) 599-5920Address: 13550 U.S. Hwy 93 Las Vegas, NV

I hereby acknowledge receipt of the above described materials
Holden, Se' Derrick 
 Name (Print or Type) Signature Date Received 03 Oct 10

81 Environmental Tech
13550 N Highway 93
Las Vegas, NV 89165

Ticket Type: INBOUND INVOICE

Ticket Number: 1595
Date: 10/03/2010
Time In: 10:19 pm
Time Out: 10:37 pm

Customer: 001011 - NGE, LLC c/o Northgate Environ Mgmt

Vehicle/Container: 82418P
Contract: Northgate Env. On Site Soils 3825 11
Comment: 3825 10 11244

Gross Weight: 131,920 LB Manual In
Tare Weight: 61,520 LB Scale Out
Net Weight: 70400 LB
Net Tons: 35.20

BOL: 11701

Origin	Yards	Material	Billing	Quantity
Not Applicable	0.00 YD	SW CONTAMINATED SOIL	35.20	TN

Driver: _____

Weighmaster: _____

HOLDENS

Indemnification. Customer agrees, by signature above, to indemnify, hold harmless, and defend Republic Services, Inc., its subsidiaries, affiliates, employees, officers and directors from and against any and all liabilities, claims, penalties, forfeitures, suits and the costs and expenses incident thereto, including costs of defense, settlement, and reasonable attorney's fees, which may be incurred, as a result of death or injuries to any person, or damage to any property, contamination of or adverse effects on the environment, caused in whole or in part by the Customer, its employees, or subcontractors in disposing waste at this Facility. In the event Customer delivers Unacceptable Waste (as determined by Republic) Customer agrees to assume all expenses and obligations with the removal and/or resolution of any effects caused by the delivery of such Unacceptable Waste.

Indemnización. Cliente acuerda indemnizar, mantener inmune, y defender Republic Services, Inc., sus subsidiarios, compañías, divisiones, empleados, oficiales y directores contra de cualquiera y de todas responsabilidades, demandas, penas, pérdidas, juicios, pleitos y los costos incidente además, incluyendo costos de defensa, de acuerdo judicial, y de honorarios razonables del abogado, que pueden ser incurridos en, o como resultado de, la muerte o herida personal a cualquier persona, o daños a cualquier característica, propiedad, contaminación de la tierra o efectos ilícitos en esta Facilidad. En el caso que el Cliente entrega, botar, basura (según lo determinado por Republic) en este Establecimiento basura inaceptable en los reglamentos de este Establecimiento, el Cliente se compromete asumir todos los costos y obligaciones con el retiro y/o la resolución de cualquier dano(s) causado por la entrega de tal basura inaceptable.



NON-HAZARDOUS WASTE MANIFEST

MANIFEST # 11701

GENERATOR INFORMATION

Generator Name: Tronox LLC

Address: P.O. Box 55

City: Henderson County: Clark

State: NV Zip: 89009

Site Location (if different): 560 W. Lake Mead

Henderson, NV 89015 (702) 592-7727

CUSTOMER/BILLING INFORMATION

Billing Name: NGE LLC c/o Northgate Environment Management

Address: 300 Frank Ogawa Plaza, Ste 510

City: Oakland County: Alameda

State: CA Zip: 94612

Republic Services Approval #	Description of Waste	Volume/Weight	Expiration Date	Container Type
38251011244	Soil for disposal	35 ²⁰ / ₁₀₀	12-31-2011	Tractor with Dump Trailer(s)
	RZ- _____ # _____			

*Attach Additional Sheet if necessary

I hereby certify that the above-described materials are non-hazardous wastes as defined by 40 CFR 261 or any applicable state law. Further, that the above named materials are properly classified, described, packaged, marked and labeled, and are in proper condition for transportation according to the applicable regulations of the Department of Transportation.

Susan Crowley Generator/Authorized Agent Name Signature Date Shipped

TRANSPORTER INFORMATION

Transporter Name: Las Vegas Paving

DOT # 191949

Address: 4420 S. Decatur

Truck Number: 220

Las Vegas, NV 89103

Phone Number: (702) 353-4355

I certify no hazardous waste or other regulated substance was knowingly introduced to the waste while in my custody. The waste transported in this vehicle is the waste identified above, to the best of my knowledge.

STEVE TAYLOR Name of Authorized Agent Signature Date Delivered 10-3-10

DISPOSAL SITE INFORMATION

Site Name: Apex Regional Landfill

Phone No. (702) 599-5920

Address: 13550 U.S. Hwy 93 Las Vegas, NV

I hereby acknowledge receipt of the above described materials Holden, So. Service Name (Print or Type) Signature Date Received 03 Oct 10

81 Environmental Tech
13550 N Highway 93
Las Vegas, NV 89165

Ticket Type: INBOUND INVOICE

Ticket Number: 1596
Date: 10/03/2010
Time In: 9:38 pm
Time Out: 10:40 pm

Customer: 001011 - NGE, LLC c/o Northgate Environ Mgmt

Vehicle/Container: 192460
Contract: Northgate Env. On Site Soils 3825 11
Comment: 3825 10 11244

Gross Weight: 124,800 LB Manual In
Tare Weight: 53,200 LB Manual Out
Net Weight: 71600 LB
Net Tons: 35.80

BOL: 11694

Origin	Yards	Material	Billing Quantity
Not Applicable	0.00 YD	SW CONTAMINATED SOIL	35.80 TN

Driver:

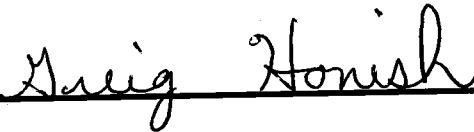

Weighmaster:

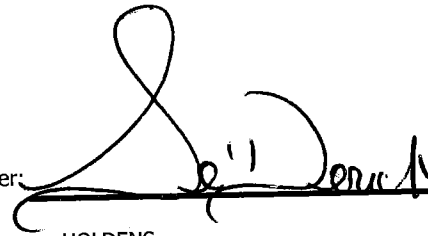

HOLDENS

Indemnification. Customer agrees, by signature above, to indemnify, hold harmless, and defend Republic Services, Inc., its subsidiaries, affiliates, employees, officers and directors from and against any and all liabilities, claims, penalties, forfeitures, suits and the costs and expenses incident thereto, including costs of defense, settlement, and reasonable attorney's fees, which may be incurred, as a result of death or injuries to any person, or damage to any property, contamination of or adverse effects on the environment, caused in whole or in part by the Customer, its employees, or subcontractors in disposing waste at this Facility. In the event Customer delivers Unacceptable Waste (as determined by Republic) Customer agrees to assume all expenses and obligations with the removal and/or resolution of any effects caused by the delivery of such Unacceptable Waste.

Indemnización. Cliente acuerda indemnizar, mantener inmune, y defender Republic Services, Inc., sus subsidiarios, compañías, divisiones, empleados, oficiales y directores contra de cualquiera y de todas responsabilidades, demandas, penas, pérdidas, juicios, pleitos y los costos incidente además, incluyendo costos de defensa, de acuerdo judicial, y de honorarios razonables del abogado, que pueden ser incurridos en, o como resultado de, la muerte o herida personal a cualquier persona, o daños a cualquier característica, propiedad, contaminación de la tierra o efectos ilícitos en esta Facilidad, causado entero o en parte por el cliente, sus empleados, o sus subcontratistas en botar basura en esta Facilidad. En el caso que el Cliente entrega, bota, basura (según lo determinado por Republic) en este Establecimiento basura inaceptable en los reglamentos de este Establecimiento, el Cliente se compromete asumir todos los costos y obligaciones con el retiro y/o la resolución de cualquier dano(s) causado por la entrega de tal basura inaceptable.



NON-HAZARDOUS WASTE MANIFEST

MANIFEST # 11694

GENERATOR INFORMATION

Generator Name: Tronox LLC

Address: P.O. Box 55

City: Henderson County: Clark

State: NV Zip: 89009

Site Location (if different): 560 W. Lake Mead

Henderson, NV 89015 (702) 592-7727

CUSTOMER/BILLING INFORMATION

Billing Name: NGE LLC c/o Northgate Environment Management

Address: 300 Frank Ogawa Plaza, Ste 510

City: Oakland County: Alameda

State: CA Zip: 94612

Republic Services Approval #	Description of Waste	Volume/Weight	Expiration Date	Container Type
38251011244	Soil for disposal	35 ⁹⁰ / _{ton}	12-31-2011	Tractor with Dump Trailer(s)
	RZ- #			

*Attach Additional Sheet if necessary

I hereby certify that the above-described materials are non-hazardous wastes as defined by 40 CFR 261 or any applicable state law. Further, that the above named materials are properly classified, described, packaged, marked and labeled, and are in proper condition for transportation according to the applicable regulations of the Department of Transportation.

Susan Crowley (Signature) Date Shipped

TRANSPORTER INFORMATION

Transporter Name: Las Vegas Paving DOT # 191949

Address: 4420 S. Decatur Truck Number: 2460

Las Vegas, NV 89103 Phone Number: (702) 353-4355

I certify no hazardous waste or other regulated substance was knowingly introduced to the waste while in my custody. The waste transported in this vehicle is the waste identified above, to the best of my knowledge.

Greg Honish (Signature) Date Delivered: 10-3-10

DISPOSAL SITE INFORMATION

Site Name: Apex Regional Landfill Phone No. (702) 599-5920

Address: 13550 U.S. Hwy 93 Las Vegas, NV

I hereby acknowledge receipt of the above described materials (Signature) Date Received: 03 Oct 10

81 Environmental Tech
13550 N Highway 93
Las Vegas, NV 89165

Ticket Type: INBOUND INVOICE

Ticket Number: 1597
Date: 10/03/2010
Time In: 9:35 pm
Time Out: 10:40 pm

Customer: 001011 - NGE, LLC c/o Northgate Environ Mgmt

Vehicle/Container: 192457

Contract: Northgate Env. On Site Soils 3825 11

Comment: 3825 10 11244

Gross Weight: 123,340 LB Manual In
Tare Weight: 51,640 LB Scale Out
Net Weight: 71700 LB
Net Tons: 35.85

BOL: 11693

Origin	Yards	Material	Billing Quantity
Not Applicable	0.00 YD	SW CONTAMINATED SOIL	35.85 TN

Driver: 

Weighmaster: 

HOLDENS

Indemnification. Customer agrees, by signature above, to indemnify, hold harmless, and defend Republic Services, Inc., its subsidiaries, affiliates, employees, officers and directors from and against any and all liabilities, claims, penalties, forfeitures, suits and the costs and expenses incident thereto, including costs of defense, settlement, and reasonable attorney's fees, which may be incurred, as a result of death or injuries to any person, or damage to any property, contamination of or adverse effects on the environment, caused in whole or in part by the Customer, its employees, or subcontractors in disposing waste at this Facility. In the event Customer delivers Unacceptable Waste (as determined by Republic) Customer agrees to assume all expenses and obligations with the removal and/or resolution of any effects caused by the delivery of such Unacceptable Waste.

Indemnización. Cliente acuerda indemnizar, mantener inmune, y defender Republic Services, Inc., sus subsidiarios, compañías, divisiones, empleados, oficiales y directores contra de cualquiera y de todas responsabilidades, demandas, penas, pérdidas, juicios, pleitos y los costos incidente además, incluyendo costos de defensa, de acuerdo judicial, y de honorarios razonables del abogado, que pueden ser incurridos en, o como resultado de, la muerte o herida personal a cualquier persona, o daños a cualquier característica, propiedad, contaminación de la tierra o efectos ilícitos en esta Facilidad, causado entero o en parte por el cliente, sus empleados, o sus subcontratistas en botar basura en esta Facilidad. En el caso que el Cliente entrega, bota, basura (según lo determinado por Republic) en este Establecimiento basura inaceptable en los reglamentos de este Establecimiento, el Cliente se compromete asumir todos los costos y obligaciones con el retiro y/o la resolución de cualquier dano(s) causado por la entrega de tal basura inaceptable.



NON-HAZARDOUS WASTE MANIFEST

MANIFEST # 11693

GENERATOR INFORMATION

Generator Name: Tronox LLC

Address: P.O. Box 55

City: Henderson County: Clark

State: NV Zip: 89009

Site Location (if different): 560 W. Lake Mead

Henderson, NV 89015 (702) 592-7727

CUSTOMER/BILLING INFORMATION

Billing Name: NGE LLC c/o Northgate Environment Management

Address: 300 Frank Ogawa Plaza, Ste 510

City: Oakland County: Alameda

State: CA Zip: 94612

Republic Services Approval #	Description of Waste	Volume/Weight	Expiration Date	Container Type
38251011244	Soil for disposal	35 ⁸⁰ / ₁₀₀	12-31-2011	Tractor with Dump Trailer(s)
	RZ- #			

*Attach Additional Sheet if necessary

I hereby certify that the above-described materials are non-hazardous wastes as defined by 40 CFR 261 or any applicable state law. Further, that the above named materials are properly classified, described, packaged, marked and labeled, and are in proper condition for transportation according to the applicable regulations of the Department of Transportation.

Susan Crowley

Generator/Authorized Agent Name

Signature

Date Shipped

TRANSPORTER INFORMATION

Transporter Name: Las Vegas Paving

DOT # 191949

Address: 4420 S. Decatur

Truck Number: 2457

Las Vegas, NV 89103

Phone Number: (702) 353-4355

I certify no hazardous waste or other regulated substance was knowingly introduced to the waste while in my custody. The waste transported in this vehicle is the waste identified above, to the best of my knowledge.

Brian Brinkhoff

Name of Authorized Agent

Signature

Date Delivered

10-3-10

DISPOSAL SITE INFORMATION

Site Name: Apex Regional Landfill

Phone No. (702) 599-5920

Address: 13550 U.S. Hwy 93 Las Vegas, NV

I hereby acknowledge receipt of the above described materials

Name (Print or Type)

Signature

Date Received

Holden, Se'Wench

Se' Derrick Holden

03 Oct 10

81 Environmental Tech
13550 N Highway 93
Las Vegas, NV 89165

Ticket Type: INBOUND INVOICE

Ticket Number: 1598
Date: 10/03/2010
Time In: 9:32 pm
Time Out: 10:43 pm

Customer: 001011 - NGE, LLC c/o Northgate Environ Mgmt

Vehicle/Container: 192456
Contract: Northgate Env. On Site Soils 3825 11
Comment: 3825 10 11244

Gross Weight: 126,600 LB Manual In
Tare Weight: 52,500 LB Scale Out
Net Weight: 74100 LB
Net Tons: 37.05

BOL: 11692

Origin	Yards	Material	Billing	Quantity
Not Applicable	0.00 YD	SW CONTAMINATED SOIL	37.05	TN

Driver: _____

Weighmaster: _____

HOLDENS

Indemnification. Customer agrees, by signature above, to indemnify, hold harmless, and defend Republic Services, Inc., its subsidiaries, affiliates, employees, officers and directors from and against any and all liabilities, claims, penalties, forfeitures, suits and the costs and expenses incident thereto, including costs of defense, settlement, and reasonable attorney's fees, which may be incurred, as a result of death or injuries to any person, or damage to any property, contamination of or adverse effects on the environment, caused in whole or in part by the Customer, its employees, or subcontractors in disposing waste at this Facility. In the event Customer delivers Unacceptable Waste (as determined by Republic) Customer agrees to assume all expenses and obligations with the removal and/or resolution of any effects caused by the delivery of such Unacceptable Waste.

Indemnización. Cliente acuerda indemnizar, mantener inmune, y defender Republic Services, Inc., sus subsidiarios, compañías, divisiones, empleados, oficiales y directores contra de cualquiera y de todas responsabilidades, demandas, penas, pérdidas, juicios, pleitos y los costos incidente además, incluyendo costos de defensa, de acuerdo judicial, y de honorarios razonables del abogado, que pueden ser incurridos en, o como resultado de, la muerte o herida personal a cualquier persona, o daños a cualquier característica, propiedad, contaminación de la tierra o efectos ilícitos en esta Facilidad, causado entero o en parte por el cliente, sus empleados, o sus subcontratistas en botar basura en esta Facilidad. En el caso que el Cliente entrega, bota, basura (según lo determinado por Republic) en este Establecimiento basura inaceptable en los reglamentos de este Establecimiento, el Cliente se compromete asumir todos los costos y obligaciones con el retiro y/o la resolución de cualquier dano(s) causado por la entrega de tal basura inaceptable.



NON-HAZARDOUS WASTE MANIFEST

MANIFEST # 11692

GENERATOR INFORMATION

Generator Name: Tronox LLC

Address: P.O. Box 55

City: Henderson County: Clark

State: NV Zip: 89009

Site Location (if different): 560 W. Lake Mead

Henderson, NV 89015 (702) 592-7727

CUSTOMER/BILLING INFORMATION

Billing Name: NGE LLC c/o Northgate Environment Management

Address: 300 Frank Ogawa Plaza, Ste 510

City: Oakland County: Alameda

State: CA Zip: 94612

Republic Services Approval #	Description of Waste	Volume/Weight	Expiration Date	Container Type
38251011244	Soil for disposal	37 ⁰⁰ / ₁₀₀	12-31-2011	Tractor with Dump Trailer(s)
	RZ- _____ # _____			

*Attach Additional Sheet if necessary

I hereby certify that the above-described materials are non-hazardous wastes as defined by 40 CFR 261 or any applicable state law. Further, that the above named materials are properly classified, described, packaged, marked and labeled, and are in proper condition for transportation according to the applicable regulations of the Department of Transportation.

Susan Crowley (Signature) Date Shipped

TRANSPORTER INFORMATION

Transporter Name: Las Vegas Paving

DOT # 191949

Address: 4420 S. Decatur

Truck Number: 192456

Las Vegas, NV 89103

Phone Number: (702) 353-4355

I certify no hazardous waste or other regulated substance was knowingly introduced to the waste while in my custody. The waste transported in this vehicle is the waste identified above, to the best of my knowledge.

Name of Authorized Agent (Signature) Date Delivered 10/3/10

DISPOSAL SITE INFORMATION

Site Name: Apex Regional Landfill

Phone No. (702) 599-5920

Address: 13550 U.S. Hwy 93 Las Vegas, NV

I hereby acknowledge receipt of the above described materials

Name (Print or Type) Holden, Se' Derrick (Signature) Date Received 03 Oct 10

81 Environmental Tech
13550 N Highway 93
Las Vegas, NV 89165

Ticket Type: INBOUND INVOICE

Ticket Number: 1599
Date: 10/03/2010
Time In: 10:20 pm
Time Out: 10:45 pm

Customer: 001011 - NGE, LLC c/o Northgate Environ Mgmt

Vehicle/Container: 81460P
Contract: Northgate Env. On Site Soils 3825 11
Comment: 3825 10 11244

Gross Weight: 125,360 LB Manual In
Tare Weight: 52,720 LB Manual Out
Net Weight: 72640 LB
Net Tons: 36.32

BOL: 11700

Origin	Yards	Material	Billing	Quantity
Not Applicable	0.00 YD	SW CONTAMINATED SOIL	36.32	TN

Driver:

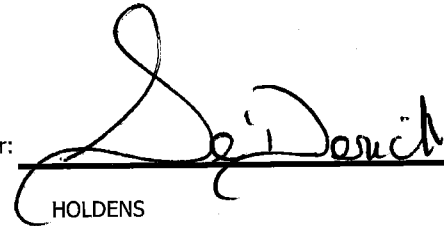

Weighmaster:

HOLDENS

Indemnification. Customer agrees, by signature above, to indemnify, hold harmless, and defend Republic Services, Inc., its subsidiaries, affiliates, employees, officers and directors from and against any and all liabilities, claims, penalties, forfeitures, suits and the costs and expenses incident thereto, including costs of defense, settlement, and reasonable attorney's fees, which may be incurred, as a result of death or injuries to any person, or damage to any property, contamination of or adverse effects on the environment, caused in whole or in part by the Customer, its employees, or subcontractors in disposing waste at this Facility. In the event Customer delivers Unacceptable Waste (as determined by Republic) Customer agrees to assume all expenses and obligations with the removal and/or resolution of any effects caused by the delivery of such Unacceptable Waste.

Indemnización. Cliente acuerda indemnizar, mantener inmune, y defender Republic Services, Inc., sus subsidiarios, compañías, divisiones, empleados, oficiales y directores contra de cualquiera y de todas responsabilidades, demandas, penas, pérdidas, juicios, pleitos y los costos incidente además, incluyendo costos de defensa, de acuerdo judicial, y de honorarios razonables del abogado, que pueden ser incurridos en, o como resultado de, la muerte o herida personal a cualquier persona, o daños a cualquier característica, propiedad, contaminación de la tierra o efectos ilícitos en esta Facilidad, causado entero o en parte por el cliente, sus empleados, o sus subcontratistas en botar basura en esta Facilidad. En el caso que el Cliente entrega, bota, basura (según lo determinado por Republic) en este Establecimiento basura inaceptable en los reglamentos de este Establecimiento, el Cliente se compromete asumir todos los costos y obligaciones con el retiro y/o la resolución de cualquier dano(s) causado por la entrega de tal basura inaceptable.



NON-HAZARDOUS WASTE MANIFEST

MANIFEST # 11700

GENERATOR INFORMATION

Generator Name: Tronox LLC
Address: P.O. Box 55
City: Henderson County: Clark
State: NV Zip: 89009
Site Location (if different): 560 W. Lake Mead
Henderson, NV 89015 (702) 592-7727

CUSTOMER/BILLING INFORMATION

Billing Name: NGE LLC c/o Northgate Environment Management
Address: 300 Frank Ogawa Plaza, Ste 510
City: Oakland County: Alameda
State: CA Zip: 94612

Table with 5 columns: Republic Services Approval #, Description of Waste, Volume/Weight, Expiration Date, Container Type. Row 1: 38251011244, Soil for disposal, 36 3/4 ton, 12-31-2011, Tractor with Dump Trailer(s).

*Attach Additional Sheet if necessary

I hereby certify that the above-described materials are non-hazardous wastes as defined by 40 CFR 261 or any applicable state law. Further, that the above named materials are properly classified, described, packaged, marked and labeled, and are in proper condition for transportation according to the applicable regulations of the Department of Transportation.

Susan Crowley
Generator/Authorized Agent Name Signature Date Shipped

TRANSPORTER INFORMATION

Transporter Name: Las Vegas Paving DOT # 191949
Address: 4420 S. Decatur Truck Number: 27
Las Vegas, NV 89103 Phone Number: (702) 353-4355

I certify no hazardous waste or other regulated substance was knowingly introduced to the waste while in my custody. The waste transported in this vehicle is the waste identified above, to the best of my knowledge.

Daniel Cardenas
Name of Authorized Agent Signature Date Delivered 10-3-2010

DISPOSAL SITE INFORMATION

Site Name: Apex Regional Landfill Phone No. (702) 599-5920
Address: 13550 U.S. Hwy 93 Las Vegas, NV

I hereby acknowledge receipt of the above described materials
Name (Print or Type) Signature Date Received 03 Oct 10

81 Environmental Tech
13550 N Highway 93
Las Vegas, NV 89165

Ticket Type: INBOUND INVOICE

Ticket Number: 1600
Date: 10/03/2010
Time In: 10:27 pm
Time Out: 10:52 pm

Customer: 001011 - NGE, LLC c/o Northgate Environ Mgmt

Vehicle/Container: 86053P

Contract: Northgate Env. On Site Soils 3825 11

Comment: ~~261~~ 3805 1011244

Gross Weight: 126,700 LB Manual In
Tare Weight: 54,980 LB Scale Out
Net Weight: 71,720 LB
Net Tons: 35.86

BOL: 11702

Origin	Yards	Material	Billing Quantity
Not Applicable	0.00 YD	SW CONTAMINATED SOIL	35.86 TN

Driver: _____

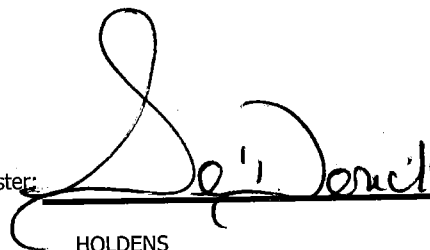

Weighmaster: _____

HOLDENS

Indemnification. Customer agrees, by signature above, to indemnify, hold harmless, and defend Republic Services, Inc., its subsidiaries, affiliates, employees, officers and directors from and against any and all liabilities, claims, penalties, forfeitures, suits and the costs and expenses incident thereto, including costs of defense, settlement, and reasonable attorney's fees, which may be incurred, as a result of death or injuries to any person, or damage to any property, contamination of or adverse effects on the environment, caused in whole or in part by the Customer, its employees, or subcontractors in disposing waste at this Facility. In the event Customer delivers Unacceptable Waste (as determined by Republic) Customer agrees to assume all expenses and obligations with the removal and/or resolution of any effects caused by the delivery of such Unacceptable Waste.

Indemnización. Cliente acuerda indemnizar, mantener inmune, y defender Republic Services, Inc., sus subsidiarios, compañías, divisiones, empleados, oficiales y directores contra de cualquiera y de todas responsabilidades, demandas, penas, pérdidas, juicios, pleitos y los costos incidente además, incluyendo costos de defensa, de acuerdo judicial, y de honorarios razonables del abogado, que pueden ser incurridos en, o como resultado de, la muerte o herida personal a cualquier persona, o daños a cualquier característica, propiedad, contaminación de la tierra o efectos ilícitos en esta Facilidad, causado entero o en parte por el cliente, sus empleados, o sus subcontratistas en botar basura en esta Facilidad. En el caso que el Cliente entrega, bota, basura (según lo determinado por Republic) en este Establecimiento basura inaceptable en los reglamentos de este Establecimiento, el Cliente se compromete asumir todos los costos y obligaciones con el retiro y/o la resolución de cualquier dano(s) causado por la entrega de tal basura inaceptable.



NON-HAZARDOUS WASTE MANIFEST

MANIFEST # 11702

GENERATOR INFORMATION

Generator Name: Tronox LLC

Address: P.O. Box 55

City: Henderson County: Clark

State: NV Zip: 89009

Site Location (if different): 560 W. Lake Mead

Henderson, NV 89015 (702) 592-7727

CUSTOMER/BILLING INFORMATION

Billing Name: NGE LLC c/o Northgate Environment Management

Address: 300 Frank Ogawa Plaza, Ste 510

City: Oakland County: Alameda

State: CA Zip: 94612

Republic Services Approval #	Description of Waste	Volume/Weight	Expiration Date	Container Type
38251011244	Soil for disposal	35 ⁹⁶ / ₁₀₀	12-31-2011	Tractor with Dump Trailer(s)
	RZ- _____ # _____			

*Attach Additional Sheet if necessary

I hereby certify that the above-described materials are non-hazardous wastes as defined by 40 CFR 261 or any applicable state law. Further, that the above named materials are properly classified, described, packaged, marked and labeled, and are in proper condition for transportation according to the applicable regulations of the Department of Transportation.

Susan Crowley (Signature) Generator/Authorized Agent Name Signature Date Shipped

TRANSPORTER INFORMATION

Transporter Name: Las Vegas Paving

DOT # 191949

Address: 4420 S. Decatur

Truck Number: 2601

Las Vegas, NV 89103

Phone Number: (702) 353-4355

I certify no hazardous waste or other regulated substance was knowingly introduced to the waste while in my custody. The waste transported in this vehicle is the waste identified above, to the best of my knowledge.

(Signature) Patrick Jones (Signature) Date Delivered 3 OCT 10

DISPOSAL SITE INFORMATION

Site Name: Apex Regional Landfill

Phone No. (702) 599-5920

Address: 13550 U.S. Hwy 93 Las Vegas, NV

I hereby acknowledge receipt of the above described materials

Holsten SeDrick (Signature) Date Received 03 Oct 10

81 Environmental Tech
13550 N Highway 93
Las Vegas, NV 89165

Ticket Type: INBOUND INVOICE

Ticket Number: 1601
Date: 10/03/2010
Time In: 10:28 pm
Time Out: 10:52 pm

Customer: 001011 - NGE, LLC c/o Northgate Environ Mgmt

Vehicle/Container: 76811P
Contract: Northgate Env. On Site Soils 3825 11
Comment: 3825 10 11244

Gross Weight: 126,520 LB Manual In
Tare Weight: 53,300 LB Manual Out
Net Weight: 73,220 LB
Net Tons: 36.61

BOL: 11703

Origin	Yards	Material	Billing	Quantity
Not Applicable	0.00 YD	SW CONTAMINATED SOIL	36.61	TN

Driver: _____

Weighmaster: _____

HOLDENS

Indemnification. Customer agrees, by signature above, to indemnify, hold harmless, and defend Republic Services, Inc., its subsidiaries, affiliates, employees, officers and directors from and against any and all liabilities, claims, penalties, forfeitures, suits and the costs and expenses incident thereto, including costs of defense, settlement, and reasonable attorney's fees, which may be incurred, as a result of death or injuries to any person, or damage to any property, contamination of or adverse effects on the environment, caused in whole or in part by the Customer, its employees, or subcontractors in disposing waste at this Facility. In the event Customer delivers Unacceptable Waste (as determined by Republic) Customer agrees to assume all expenses and obligations with the removal and/or resolution of any effects caused by the delivery of such Unacceptable Waste.

Indemnización. Cliente acuerda indemnizar, mantener inmune, y defender Republic Services, Inc., sus subsidiarios, compañías, divisiones, empleados, oficiales y directores contra de cualquiera y de todas responsabilidades, demandas, penas, pérdidas, juicios, pleitos y los costos incidente además, incluyendo costos de defensa, de acuerdo judicial, y de honorarios razonables del abogado, que pueden ser incurridos en, o como resultado de, la muerte o herida personal a cualquier persona, o daños a cualquier característica, propiedad, contaminación de la tierra o efectos ilícitos en esta Facilidad, causado entero o en parte por el cliente, sus empleados, o sus subcontratistas en botar basura en esta Facilidad. En el caso que el Cliente entrega, bota, basura (según lo determinado por Republic) en este Establecimiento basura inaceptable en los reglamentos de este Establecimiento, el Cliente se compromete asumir todos los costos y obligaciones con el retiro y/o la resolución de cualquier dano(s) causado por la entrega de tal basura inaceptable.



NON-HAZARDOUS WASTE MANIFEST

MANIFEST # 11703

GENERATOR INFORMATION

Generator Name: Tronox LLC

Address: P.O. Box 55

City: Henderson County: Clark

State: NV Zip: 89009

Site Location (if different): 560 W. Lake Mead
Henderson, NV 89015 (702) 592-7727

CUSTOMER/BILLING INFORMATION

Billing Name: NGE LLC c/o Northgate Environment Management

Address: 300 Frank Ogawa Plaza, Ste 510

City: Oakland County: Alameda

State: CA Zip: 94612

Table with 5 columns: Republic Services Approval #, Description of Waste, Volume/Weight, Expiration Date, Container Type. Row 1: 38251011244, Soil for disposal, 36 61/70s, 12-31-2011, Tractor with Dump Trailer(s). Row 2: RZ- #

*Attach Additional Sheet if necessary

I hereby certify that the above-described materials are non-hazardous wastes as defined by 40 CFR 261 or any applicable state law. Further, that the above named materials are properly classified, described, packaged, marked and labeled, and are in proper condition for transportation according to the applicable regulations of the Department of Transportation.

Susan Crowley (Signature)
Generator/Authorized Agent Name Signature Date Shipped

TRANSPORTER INFORMATION

Transporter Name: Las Vegas Paving

DOT # 191949

Address: 4420 S. Decatur

Truck Number: 242

Las Vegas, NV 89103

Phone Number: (702) 353-4355

I certify no hazardous waste or other regulated substance was knowingly introduced to the waste while in my custody. The waste transported in this vehicle is the waste identified above, to the best of my knowledge.

STEVE MAYES (Signature)
Name of Authorized Agent Signature Date Delivered 10/3/10

DISPOSAL SITE INFORMATION

Site Name: Apex Regional Landfill

Phone No. (702) 599-5920

Address: 13550 U.S. Hwy 93 Las Vegas, NV

I hereby acknowledge receipt of the above described materials

Holden, Sr. Daniel (Signature)
Name (Print or Type) Signature Date Received 03 Oct 10

81 Environmental Tech
13550 N Highway 93
Las Vegas, NV 89165

Ticket Type: INBOUND INVOICE

Ticket Number: 1602
Date: 10/03/2010
Time In: 10:32 pm
Time Out: 10:54 pm

Customer: 001011 - NGE, LLC c/o Northgate Environ Mgmt

Vehicle/Container: 76810P
Contract: Northgate Env. On Site Soils 3825 11
Comment: 3825 10 11244

Gross Weight: 113,820 LB Manual In
Tare Weight: 55,220 LB Scale Out
Net Weight: 58600 LB
Net Tons: 29.30

BOL: 11704

Origin	Yards	Material	Billing	Quantity
Not Applicable	0.00 YD	SW CONTAMINATED SOIL	29.30	TN

Driver:

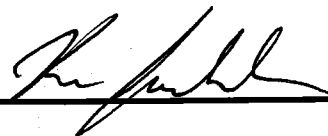

Weighmaster:

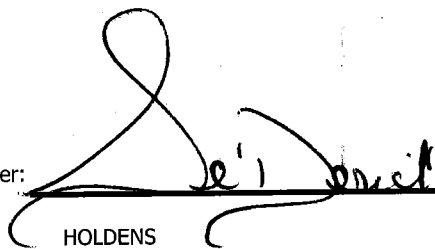
HOLDENS

Indemnification. Customer agrees, by signature above, to indemnify, hold harmless, and defend Republic Services, Inc., its subsidiaries, affiliates, employees, officers and directors from and against any and all liabilities, claims, penalties, forfeitures, suits and the costs and expenses incident thereto, including costs of defense, settlement, and reasonable attorney's fees, which may be incurred, as a result of death or injuries to any person, or damage to any property, contamination of or adverse effects on the environment, caused in whole or in part by the Customer, its employees, or subcontractors in disposing waste at this Facility. In the event Customer delivers Unacceptable Waste (as determined by Republic) Customer agrees to assume all expenses and obligations with the removal and/or resolution of any effects caused by the delivery of such Unacceptable Waste.

Indemnización. Cliente acuerda indemnizar, mantener inmune, y defender Republic Services, Inc., sus subsidiarios, compañías, divisiones, empleados, oficiales y directores contra de cualquiera y de todas responsabilidades, demandas, penas, pérdidas, juicios, pleitos y los costos incidente además, incluyendo costos de defensa, de acuerdo judicial, y de honorarios razonables del abogado, que pueden ser incurridos en, o como resultado de, la muerte o herida personal a cualquier persona, o daños a cualquier característica, propiedad, contaminación de la tierra o efectos ilícitos en esta Facilidad, causado entero o en parte por el cliente, sus empleados, o sus subcontratistas en botar basura en esta Facilidad. En el caso que el Cliente entrega, bota, basura (según lo determinado por Republic) en este Establecimiento basura inaceptable en los reglamentos de este Establecimiento, el Cliente se compromete asumir todos los costos y obligaciones con el retiro y/o la resolución de cualquier dano(s) causado por la entrega de tal basura inaceptable.



NON-HAZARDOUS WASTE MANIFEST

MANIFEST # 11704

GENERATOR INFORMATION

Generator Name: Tronox LLC

Address: P.O. Box 55

City: Henderson County: Clark

State: NV Zip: 89009

Site Location (if different): 560 W. Lake Mead
Henderson, NV 89015 (702) 592-7727

CUSTOMER/BILLING INFORMATION

Billing Name: NGE LLC c/o Northgate Environment Management

Address: 300 Frank Ogawa Plaza, Ste 510

City: Oakland County: Alameda

State: CA Zip: 94612

Table with 5 columns: Republic Services Approval #, Description of Waste, Volume/Weight, Expiration Date, Container Type. Row 1: 38251011244, Soil for disposal, 29 7/8 ton, 12-31-2011, Tractor with Dump Trailer(s). Row 2: RZ- #

*Attach Additional Sheet if necessary

I hereby certify that the above-described materials are non-hazardous wastes as defined by 40 CFR 261 or any applicable state law. Further, that the above named materials are properly classified, described, packaged, marked and labeled, and are in proper condition for transportation according to the applicable regulations of the Department of Transportation.

Susan Crowley (Signature)
Generator/Authorized Agent Name Signature Date Shipped

TRANSPORTER INFORMATION

Transporter Name: Las Vegas Paving

DOT # 191949

Address: 4420 S. Decatur

Truck Number: 241

Las Vegas, NV 89103

Phone Number: (702) 353-4355

I certify no hazardous waste or other regulated substance was knowingly introduced to the waste while in my custody. The waste transported in this vehicle is the waste identified above, to the best of my knowledge.

Ken J. [Signature] (Signature) 10-3-2010 (Date Delivered)
Name of Authorized Agent Signature Date Delivered

DISPOSAL SITE INFORMATION

Site Name: Apex Regional Landfill

Phone No. (702) 599-5920

Address: 13550 U.S. Hwy 93 Las Vegas, NV

I hereby acknowledge receipt of the above described materials

Holden, S. Wick (Signature) 03 Oct 10 (Date Received)
Name (Print or Type) Signature Date Received

81 Environmental Tech
13550 N Highway 93
Las Vegas, NV 89165

Ticket Type: INBOUND INVOICE

Ticket Number: 1603
Date: 10/03/2010
Time In: 10:42 pm
Time Out: 11:08 pm

Customer: 001011 - NGE, LLC c/o Northgate Environ Mgmt

Vehicle/Container: 68263P
Contract: Northgate Env. On Site Soils 3825 11
Comment: 3825 10 11244

Gross Weight: 124,820 LB Manual In
Tare Weight: 53,460 LB Scale Out
Net Weight: 71360 LB
Net Tons: 35.68

BOL: 11705

Origin	Yards	Material	Billing Quantity
Not Applicable	0.00 YD	SW CONTAMINATED SOIL	35.68 TN

Driver:

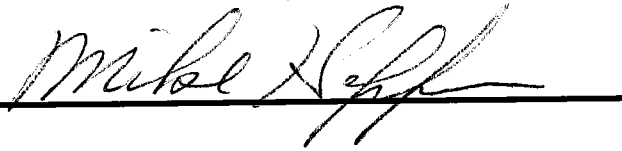

Weighmaster:

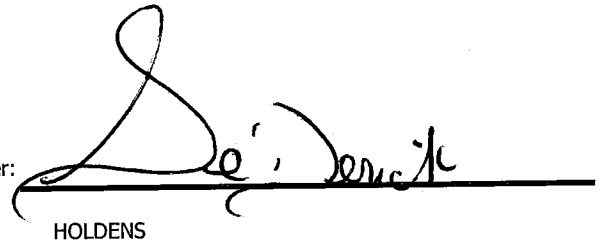

HOLDENS

Indemnification. Customer agrees, by signature above, to indemnify, hold harmless, and defend Republic Services, Inc., its subsidiaries, affiliates, employees, officers and directors from and against any and all liabilities, claims, penalties, forfeitures, suits and the costs and expenses incident thereto, including costs of defense, settlement, and reasonable attorney's fees, which may be incurred, as a result of death or injuries to any person, or damage to any property, contamination of or adverse effects on the environment, caused in whole or in part by the Customer, its employees, or subcontractors in disposing waste at this Facility. In the event Customer delivers Unacceptable Waste (as determined by Republic) Customer agrees to assume all expenses and obligations with the removal and/or resolution of any effects caused by the delivery of such Unacceptable Waste.

Indemnización. Cliente acuerda indemnizar, mantener inmune, y defender Republic Services, Inc., sus subsidiarios, companias, divisiones, empleados, oficiales y directores contra de cualquiera y de todas responsabilidades, demandas, penas, pérdidas, juicios, pleitos y los costos incidente además, incluyendo costos de defensa, de acuerdo judicial, y de honorarios razonables del abogado, que pueden ser incurridos en, o como resultado de, la muerte o herida personal a cualquier persona, o daños a cualquier característica, propiedad, contaminación de la tierra o efectos ilicitos en esta Facilidad, causado entero o en parte por el cliente, sus empleados, o sus subcontratistas en botar basura en esta Facilidad. En el caso que el Cliente entrega, bota, basura (según lo determinado por Republic) en este Establecimiento basura inaceptable en los reglamentos de este Establecimiento, el Cliente se compromete asumir todos los costos y obligaciones con el retiro y/o la resolución de cualquier dano(s) causado por la entrega de tal basura inaceptable.



NON-HAZARDOUS WASTE MANIFEST

MANIFEST # 11705

GENERATOR INFORMATION

Generator Name: Tronox LLC
Address: P.O. Box 55
City: Henderson County: Clark
State: NV Zip: 89009
Site Location (if different): 560 W. Lake Mead
Henderson, NV 89015 (702) 592-7727

CUSTOMER/BILLING INFORMATION

Billing Name: NGE LLC c/o Northgate Environment Management
Address: 300 Frank Ogawa Plaza, Ste 510
City: Oakland County: Alameda
State: CA Zip: 94612

Table with 5 columns: Republic Services Approval #, Description of Waste, Volume/Weight, Expiration Date, Container Type. Row 1: 38251011244, Soil for disposal, 35 68/100, 12-31-2011, Tractor with Dump Trailer(s).

*Attach Additional Sheet if necessary

I hereby certify that the above-described materials are non-hazardous wastes as defined by 40 CFR 261 or any applicable state law. Further, that the above named materials are properly classified, described, packaged, marked and labeled, and are in proper condition for transportation according to the applicable regulations of the Department of Transportation.

Susan Crowley (Signature)
Generator/Authorized Agent Name Signature Date Shipped

TRANSPORTER INFORMATION

Transporter Name: Las Vegas Paving DOT # 191949
Address: 4420 S. Decatur Truck Number: 7711
Las Vegas, NV 89103 Phone Number: (702) 353-4355

I certify no hazardous waste or other regulated substance was knowingly introduced to the waste while in my custody. The waste transported in this vehicle is the waste identified above, to the best of my knowledge.

Mike Hefferon (Signature)
Name of Authorized Agent Signature Date Delivered 10-3-10

DISPOSAL SITE INFORMATION

Site Name: Apex Regional Landfill Phone No. (702) 599-5920
Address: 13550 U.S. Hwy 93 Las Vegas, NV

I hereby acknowledge receipt of the above described materials
Holden, Se'Derick (Signature)
Name (Print or Type) Signature Date Received 03 Oct 10

81 Environmental Tech
13550 N Highway 93
Las Vegas, NV 89165

Ticket Type: INBOUND INVOICE

Ticket Number: 1604
Date: 10/03/2010
Time In: 10:49 pm
Time Out: 11:12 pm

Customer: 001011 - NGE, LLC c/o Northgate Environ Mgmt

Vehicle/Container: 86113P
Contract: Northgate Env. On Site Soils 3825 11
Comment: 3825 10 11244

Gross Weight: 130,860 LB Manual In
Tare Weight: 55,580 LB Scale Out
Net Weight: 75280 LB
Net Tons: 37.64

BOL: 11706

Origin	Yards	Material	Billing	Quantity
Not Applicable	0.00 YD	SW CONTAMINATED SOIL	37.64	TN

Driver:

J. A. H.

Weighmaster:

[Signature]
HOLDENS

Indemnification. Customer agrees, by signature above, to indemnify, hold harmless, and defend Republic Services, Inc., its subsidiaries, affiliates, employees, officers and directors from and against any and all liabilities, claims, penalties, forfeitures, suits and the costs and expenses incident thereto, including costs of defense, settlement, and reasonable attorney's fees, which may be incurred, as a result of death or injuries to any person, or damage to any property, contamination of or adverse effects on the environment, caused in whole or in part by the Customer, its employees, or subcontractors in disposing waste at this Facility. In the event Customer delivers Unacceptable Waste (as determined by Republic) Customer agrees to assume all expenses and obligations with the removal and/or resolution of any effects caused by the delivery of such Unacceptable Waste.

Indemnización. Cliente acuerda indemnizar, mantener inmune, y defender Republic Services, Inc., sus subsidiarios, compañías, divisiones, empleados, oficiales y directores contra de cualquiera y de todas responsabilidades, demandas, penas, pérdidas, juicios, pleitos y los costos incidente además, incluyendo costos de defensa, de acuerdo judicial, y de honorarios razonables del abogado, que pueden ser incurridos en, o como resultado de, la muerte o herida personal a cualquier persona, o daños a cualquier característica, propiedad, contaminación de la tierra o efectos ilícitos en esta Facilidad, causado entero o en parte por el cliente, sus empleados, o sus subcontratistas en botar basura en esta Facilidad. En el caso que el Cliente entrega, bota, basura (según lo determinado por Republic) en este Establecimiento basura inaceptable en los reglamentos de este Establecimiento, el Cliente se compromete asumir todos los costos y obligaciones con el retiro y/o la resolución de cualquier dano(s) causado por la entrega de tal basura inaceptable.



NON-HAZARDOUS WASTE MANIFEST

MANIFEST # 11706

GENERATOR INFORMATION

Generator Name: Tronox LLC
Address: P.O. Box 55
City: Henderson County: Clark
State: NV Zip: 89009
Site Location (if different): 560 W. Lake Mead
Henderson, NV 89015 (702) 592-7727

CUSTOMER/BILLING INFORMATION

Billing Name: NGE LLC c/o Northgate Environment Management
Address: 300 Frank Ogawa Plaza, Ste 510
City: Oakland County: Alameda
State: CA Zip: 94612

Table with 5 columns: Republic Services Approval #, Description of Waste, Volume/Weight, Expiration Date, Container Type. Row 1: 38251011244, Soil for disposal, 37 64/100, 12-31-2011, Tractor with Dump Trailer(s).

*Attach Additional Sheet if necessary

I hereby certify that the above-described materials are non-hazardous wastes as defined by 40 CFR 261 or any applicable state law. Further, that the above named materials are properly classified, described, packaged, marked and labeled, and are in proper condition for transportation according to the applicable regulations of the Department of Transportation.

Susan Crowley (Signature)
Generator/Authorized Agent Name Signature Date Shipped

TRANSPORTER INFORMATION

Transporter Name: Las Vegas Paving DOT # 191949
Address: 4420 S. Decatur Truck Number: K0019/7
Las Vegas, NV 89103 Phone Number: (702) 353-4355

I certify no hazardous waste or other regulated substance was knowingly introduced to the waste while in my custody. The waste transported in this vehicle is the waste identified above, to the best of my knowledge.

ALBERTO HERRERA (Signature)
Name of Authorized Agent Signature Date Delivered Oct 3, 2010

DISPOSAL SITE INFORMATION

Site Name: Apex Regional Landfill Phone No. (702) 599-5920
Address: 13550 U.S. Hwy 93 Las Vegas, NV

I hereby acknowledge receipt of the above described materials
Holden, Se' Jerich (Signature)
Name (Print or Type) Signature Date Received 03 Oct 10

81 Environmental Tech
13550 N Highway 93
Las Vegas, NV 89165

Ticket Type: INBOUND INVOICE

Ticket Number: 1605
Date: 10/03/2010
Time In: 11:02 pm
Time Out: 11:31 pm

Customer: 001011 - NGE, LLC c/o Northgate Environ Mgmt

Vehicle/Container: 44166A
Contract: Northgate Env. On Site Soils 3825 11
Comment: 3825 10 11244

Gross Weight: 138,760 LB Manual In
Tare Weight: 57,380 LB Scale Out
Net Weight: 81380 LB
Net Tons: 40.69

BOL: 11707

Origin	Yards	Material	Billing	Quantity
Not Applicable	0.00 YD	SW CONTAMINATED SOIL	40.69	TN

Driver: _____

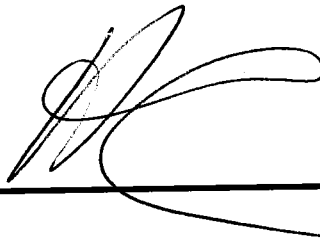

Weighmaster: _____

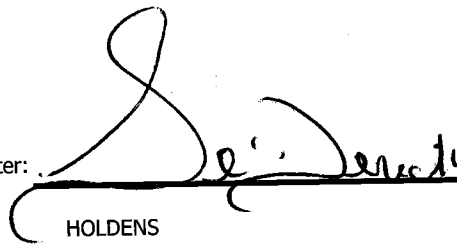
HOLDENS

Indemnification. Customer agrees, by signature above, to indemnify, hold harmless, and defend Republic Services, Inc., its subsidiaries, affiliates, employees, officers and directors from and against any and all liabilities, claims, penalties, forfeitures, suits and the costs and expenses incident thereto, including costs of defense, settlement, and reasonable attorney's fees, which may be incurred, as a result of death or injuries to any person, or damage to any property, contamination of or adverse effects on the environment, caused in whole or in part by the Customer, its employees, or subcontractors in disposing waste at this Facility. In the event Customer delivers Unacceptable Waste (as determined by Republic) Customer agrees to assume all expenses and obligations with the removal and/or resolution of any effects caused by the delivery of such Unacceptable Waste.

Indemnización. Cliente acuerda indemnizar, mantener inmune, y defender Republic Services, Inc., sus subsidiarios, compañías, divisiones, empleados, oficiales y directores contra de cualquiera y de todas responsabilidades, demandas, penas, pérdidas, juicios, pleitos y los costos incidente además, incluyendo costos de defensa, de acuerdo judicial, y de honorarios razonables del abogado, que pueden ser incurridos en, o como resultado de, la muerte o herida personal a cualquier persona, o daños a cualquier característica, propiedad, contaminación de la tierra o efectos ilícitos en esta Facilidad. En el caso que el Cliente entrega, bota, basura (según lo determinado por Republic) en este Establecimiento basura inaceptable en los reglamentos de este Establecimiento, el Cliente se compromete asumir todos los costos y obligaciones con el retiro y/o la resolución de cualquier dano(s) causado por la entrega de tal basura inaceptable.



NON-HAZARDOUS WASTE MANIFEST

MANIFEST # 11707

GENERATOR INFORMATION

Generator Name: Tronox LLC
Address: P.O. Box 55
City: Henderson County: Clark
State: NV Zip: 89009
Site Location (if different): 560 W. Lake Mead
Henderson, NV 89015 (702) 592-7727

CUSTOMER/BILLING INFORMATION

Billing Name: NGE LLC c/o Northgate Environment Management
Address: 300 Frank Ogawa Plaza, Ste 510
City: Oakland County: Alameda
State: CA Zip: 94612

Table with 5 columns: Republic Services Approval #, Description of Waste, Volume/Weight, Expiration Date, Container Type. Row 1: 38251011244, Soil for disposal, 210 69/100, 12-31-2011, Tractor with Dump Trailer(s)

*Attach Additional Sheet if necessary

I hereby certify that the above-described materials are non-hazardous wastes as defined by 40 CFR 261 or any applicable state law. Further, that the above named materials are properly classified, described, packaged, marked and labeled, and are in proper condition for transportation according to the applicable regulations of the Department of Transportation.

Susan Crowley
Generator/Authorized Agent Name Signature Date Shipped

TRANSPORTER INFORMATION

Transporter Name: Las Vegas Paving DOT # 191949
Address: 4420 S. Decatur Truck Number: K002
Las Vegas, NV 89103 Phone Number: (702) 353-4355

I certify no hazardous waste or other regulated substance was knowingly introduced to the waste while in my custody. The waste transported in this vehicle is the waste identified above, to the best of my knowledge.

Spago Castell
Name of Authorized Agent Signature Date Delivered 10-3-10

DISPOSAL SITE INFORMATION

Site Name: Apex Regional Landfill Phone No. (702) 599-5920
Address: 13550 U.S. Hwy 93 Las Vegas, NV

I hereby acknowledge receipt of the above described materials
Name (Print or Type) Signature Date Received 03 Oct 10

81 Environmental Tech
13550 N Highway 93
Las Vegas, NV 89165

Ticket Type: INBOUND INVOICE

Ticket Number: 1606
Date: 10/03/2010
Time In: 11:04 pm
Time Out: 11:31 pm

Customer: 001011 - NGE, LLC c/o Northgate Environ Mgmt

Vehicle/Container: 43078A
Contract: Northgate Env. On Site Soils 3825 11
Comment: 3825 10 11244

Gross Weight: 123,300 LB Manual In
Tare Weight: 52,620 LB Manual Out
Net Weight: 70680 LB
Net Tons: 35.34

BOL: 11708

Origin	Yards	Material	Billing	Quantity
Not Applicable	0.00 YD	SW CONTAMINATED SOIL	35.34	TN

Driver: _____

Weighmaster: _____

HOLDENS

Indemnification. Customer agrees, by signature above, to indemnify, hold harmless, and defend Republic Services, Inc., its subsidiaries, affiliates, employees, officers and directors from and against any and all liabilities, claims, penalties, forfeitures, suits and the costs and expenses incident thereto, including costs of defense, settlement, and reasonable attorney's fees, which may be incurred, as a result of death or injuries to any person, or damage to any property, contamination of or adverse effects on the environment, caused in whole or in part by the Customer, its employees, or subcontractors in disposing waste at this Facility. In the event Customer delivers Unacceptable Waste (as determined by Republic) Customer agrees to assume all expenses and obligations with the removal and/or resolution of any effects caused by the delivery of such Unacceptable Waste.

Indemnización. Cliente acuerda indemnizar, mantener inmune, y defender Republic Services, Inc., sus subsidiarios, compañías, divisiones, empleados, oficiales y directores contra de cualquiera y de todas responsabilidades, demandas, penas, pérdidas, juicios, pleitos y los costos incidente además, incluyendo costos de defensa, de acuerdo judicial, y de honorarios razonables del abogado, que pueden ser incurridos en, o como resultado de, la muerte o herida personal a cualquier persona, o daños a cualquier característica, propiedad, contaminación de la tierra o efectos ilícitos en esta Facilidad, causado entero o en parte por el cliente, sus empleados, o sus subcontratistas en botar basura en esta Facilidad. En el caso que el Cliente entrega, bota, basura (según lo determinado por Republic) en este Establecimiento basura inaceptable en los reglamentos de este Establecimiento, el Cliente se compromete asumir todos los costos y obligaciones con el retiro y/o la resolución de cualquier dano(s) causado por la entrega de tal basura inaceptable.



NON-HAZARDOUS WASTE MANIFEST

MANIFEST # 11708

GENERATOR INFORMATION

Generator Name: Tronox LLC

Address: P.O. Box 55

City: Henderson County: Clark

State: NV Zip: 89009

Site Location (if different): 560 W. Lake Mead

Henderson, NV 89015 (702) 592-7727

CUSTOMER/BILLING INFORMATION

Billing Name: NGE LLC c/o Northgate Environment Management

Address: 300 Frank Ogawa Plaza, Ste 510

City: Oakland County: Alameda

State: CA Zip: 94612

Republic Services Approval #	Description of Waste	Volume/Weight	Expiration Date	Container Type
38251011244	Soil for disposal	35 ^{3/4} Ton	12-31-2011	Tractor with Dump Trailer(s)
	RZ- #			

*Attach Additional Sheet if necessary

I hereby certify that the above-described materials are non-hazardous wastes as defined by 40 CFR 261 or any applicable state law. Further, that the above named materials are properly classified, described, packaged, marked and labeled, and are in proper condition for transportation according to the applicable regulations of the Department of Transportation.

Susan Crowley (Signature) Generator/Authorized Agent Name Signature Date Shipped

TRANSPORTER INFORMATION

Transporter Name: Las Vegas Paving

DOT # 191949

Address: 4420 S. Decatur

Truck Number: DNF 200

Las Vegas, NV 89103

Phone Number: (702) 353-4355

I certify no hazardous waste or other regulated substance was knowingly introduced to the waste while in my custody. The waste transported in this vehicle is the waste identified above, to the best of my knowledge.

Dean Frehrer (Signature) Name of Authorized Agent Signature Date Delivered 10-3-10

DISPOSAL SITE INFORMATION

Site Name: Apex Regional Landfill

Phone No. (702) 599-5920

Address: 13550 U.S. Hwy 93 Las Vegas, NV

I hereby acknowledge receipt of the above described materials

Holden, Se' Derek (Signature) Name (Print or Type) Signature Date Received 03 Oct 10

81 Environmental Tech
13550 N Highway 93
Las Vegas, NV 89165

Ticket Type: INBOUND INVOICE

Ticket Number: 1607
Date: 10/03/2010
Time In: 11:10 pm
Time Out: 11:33 pm

Customer: 001011 - NGE, LLC c/o Northgate Environ Mgmt

Vehicle/Container: 82290P
Contract: Northgate Env. On Site Soils 3825 11
Comment: 3825 10 11244

Gross Weight: 128,640 LB Manual In
Tare Weight: 54,940 LB Scale Out
Net Weight: 73700 LB
Net Tons: 36.85

BOL: 11709

Origin	Yards	Material	Billing	Quantity
Not Applicable	0.00 YD	SW CONTAMINATED SOIL	36.85	TN

Driver:

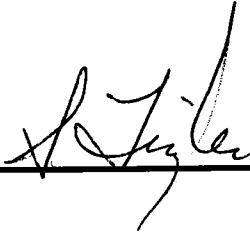

Weighmaster:

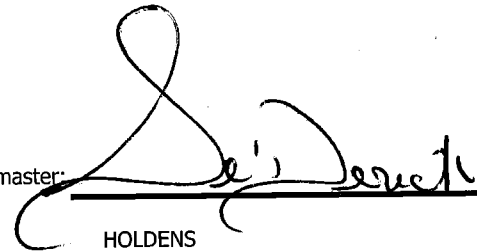
HOLDENS

Indemnification. Customer agrees, by signature above, to indemnify, hold harmless, and defend Republic Services, Inc., its subsidiaries, affiliates, employees, officers and directors from and against any and all liabilities, claims, penalties, forfeitures, suits and the costs and expenses incident thereto, including costs of defense, settlement, and reasonable attorney's fees, which may be incurred, as a result of death or injuries to any person, or damage to any property, contamination of or adverse effects on the environment, caused in whole or in part by the Customer, its employees, or subcontractors in disposing waste at this Facility. In the event Customer delivers Unacceptable Waste (as determined by Republic) Customer agrees to assume all expenses and obligations with the removal and/or resolution of any effects caused by the delivery of such Unacceptable Waste.

Indemnización. Cliente acuerda indemnizar, mantener inmune, y defender Republic Services, Inc., sus subsidiarios, compañías, divisiones, empleados, oficiales y directores contra de cualquiera y de todas responsabilidades, demandas, penas, pérdidas, juicios, pleitos y los costos incidente además, incluyendo costos de defensa, de acuerdo judicial, y de honorarios razonables del abogado, que pueden ser incurridos en, o como resultado de, la muerte o herida personal a cualquier persona, o daños a cualquier característica, propiedad, contaminación de la tierra o efectos ilícitos en esta Facilidad, causado entero o en parte por el cliente, sus empleados, o sus subcontratistas en botar basura en esta Facilidad. En el caso que el Cliente entrega, bota, basura (según lo determinado por Republic) en este Establecimiento basura inaceptable en los reglamentos de este Establecimiento, el Cliente se compromete asumir todos los costos y obligaciones con el retiro y/o la resolución de cualquier dano(s) causado por la entrega de tal basura inaceptable.



NON-HAZARDOUS WASTE MANIFEST

MANIFEST # 11709

GENERATOR INFORMATION

Generator Name: Tronox LLC

Address: P.O. Box 55

City: Henderson County: Clark

State: NV Zip: 89009

Site Location (if different): 560 W. Lake Mead

Henderson, NV 89015 (702) 592-7727

CUSTOMER/BILLING INFORMATION

Billing Name: NGE LLC c/o Northgate Environment Management

Address: 300 Frank Ogawa Plaza, Ste 510

City: Oakland County: Alameda

State: CA Zip: 94612

Republic Services Approval #	Description of Waste	Volume/Weight	Expiration Date	Container Type
38251011244	Soil for disposal	36 ⁸⁵ / _{75n}	12-31-2011	Tractor with Dump Trailer(s)
	RZ- #			

*Attach Additional Sheet if necessary

I hereby certify that the above-described materials are non-hazardous wastes as defined by 40 CFR 261 or any applicable state law. Further, that the above named materials are properly classified, described, packaged, marked and labeled, and are in proper condition for transportation according to the applicable regulations of the Department of Transportation.

Susan Crowley

Susan Crowley

Generator/Authorized Agent Name

Signature

Date Shipped

TRANSPORTER INFORMATION

Transporter Name: Las Vegas Paving

DOT # 191949

Address: 4420 S. Decatur

Truck Number: 86

Las Vegas, NV 89103

Phone Number: (702) 353-4355

I certify no hazardous waste or other regulated substance was knowingly introduced to the waste while in my custody. The waste transported in this vehicle is the waste identified above, to the best of my knowledge.

TRIGLER, STEVE

Steve Trigler

10-3-10

Name of Authorized Agent

Signature

Date Delivered

DISPOSAL SITE INFORMATION

Site Name: Apex Regional Landfill

Phone No. (702) 599-5920

Address: 13550 U.S. Hwy 93 Las Vegas, NV

I hereby acknowledge receipt of the above described materials

Derrick Holden

03 Oct 10

Name (Print or Type)

Signature

Date Received

81 Environmental Tech
13550 N Highway 93
Las Vegas, NV 89165

Ticket Type: INBOUND INVOICE

Ticket Number: 1608
Date: 10/03/2010
Time In: 11:26 pm
Time Out: 11:51 pm

Customer: 001011 - NGE, LLC c/o Northgate Environ Mgmt

Vehicle/Container: 44564A
Contract: Northgate Env. On Site Soils 3825 11
Comment: 3825 10 11244

Gross Weight: 130,520 LB Manual In
Tare Weight: 49,140 LB Scale Out
Net Weight: 81380 LB
Net Tons: 40.69

BOL: 11711

Origin	Yards	Material	Billing	Quantity
Not Applicable	0.00 YD	SW CONTAMINATED SOIL	40.69	TN

Driver: 

Weighmaster: 

HOLDENS

Indemnification. Customer agrees, by signature above, to indemnify, hold harmless, and defend Republic Services, Inc., its subsidiaries, affiliates, employees, officers and directors from and against any and all liabilities, claims, penalties, forfeitures, suits and the costs and expenses incident thereto, including costs of defense, settlement, and reasonable attorney's fees, which may be incurred, as a result of death or injuries to any person, or damage to any property, contamination of or adverse effects on the environment, caused in whole or in part by the Customer, its employees, or subcontractors in disposing waste at this Facility. In the event Customer delivers Unacceptable Waste (as determined by Republic) Customer agrees to assume all expenses and obligations with the removal and/or resolution of any effects caused by the delivery of such Unacceptable Waste.

Indemnización. Cliente acuerda indemnizar, mantener inmune, y defender Republic Services, Inc., sus subsidiarios, compañías, divisiones, empleados, oficiales y directores contra de cualquiera y de todas responsabilidades, demandas, penas, pérdidas, juicios, pleitos y los costos incidente además, incluyendo costos de defensa, de acuerdo judicial, y de honorarios razonables del abogado, que pueden ser incurridos en, o como resultado de, la muerte o herida personal a cualquier persona, o daños a cualquier característica, propiedad, contaminación de la tierra o efectos ilícitos en esta Facilidad, causado entero o en parte por el cliente, sus empleados, o sus subcontratistas en botar basura en esta Facilidad. En el caso que el Cliente entrega, bota, basura (según lo determinado por Republic) en este Establecimiento basura inaceptable en los reglamentos de este Establecimiento, el Cliente se compromete asumir todos los costos y obligaciones con el retiro y/o la resolución de cualquier dano(s) causado por la entrega de tal basura inaceptable.



NON-HAZARDOUS WASTE MANIFEST

MANIFEST # 11711

GENERATOR INFORMATION

Generator Name: Tronox LLC

Address: P.O. Box 55

City: Henderson County: Clark

State: NV Zip: 89009

Site Location (if different): 560 W. Lake Mead

Henderson, NV 89015 (702) 592-7727

CUSTOMER/BILLING INFORMATION

Billing Name: NGE LLC c/o Northgate Environment Management

Address: 300 Frank Ogawa Plaza, Ste 510

City: Oakland County: Alameda

State: CA Zip: 94612

Republic Services Approval #	Description of Waste	Volume/Weight	Expiration Date	Container Type
38251011244	Soil for disposal	410 ⁶⁹ / ₁₅₇	12-31-2011	Tractor with Dump Trailer(s)
	RZ- _____ # _____			

*Attach Additional Sheet if necessary

I hereby certify that the above-described materials are non-hazardous wastes as defined by 40 CFR 261 or any applicable state law. Further, that the above named materials are properly classified, described, packaged, marked and labeled, and are in proper condition for transportation according to the applicable regulations of the Department of Transportation.

Susan Crowley *Susan Crowley* _____
 Generator/Authorized Agent Name Signature Date Shipped

TRANSPORTER INFORMATION

Transporter Name: Las Vegas Paving

DOT # 191949

Address: 4420 S. Decatur

Truck Number: K0003

Las Vegas, NV 89103

Phone Number: (702) 353-4355

I certify no hazardous waste or other regulated substance was knowingly introduced to the waste while in my custody. The waste transported in this vehicle is the waste identified above, to the best of my knowledge.

Asencion *Asencion* _____ 10/03/10
 Name of Authorized Agent Signature Date Delivered

DISPOSAL SITE INFORMATION

Site Name: Apex Regional Landfill

Phone No. (702) 599-5920

Address: 13550 U.S. Hwy 93 Las Vegas, NV

I hereby acknowledge receipt of the above described materials

Holden, Se'... *Se'...* _____ 03 Oct 10
 Name (Print or Type) Signature Date Received

81 Environmental Tech
13550 N Highway 93
Las Vegas, NV 89165

Ticket Type: INBOUND INVOICE

Ticket Number: 1609
Date: 10/03/2010
Time In: 11:28 pm
Time Out: 11:59 pm

Customer: 001011 - NGE, LLC c/o Northgate Environ Mgmt

Vehicle/Container: 44164A
Contract: Northgate Env. On Site Soils 3825 11
Comment: 3825 10 11244

Gross Weight: 123,120 LB Manual In
Tare Weight: 51,100 LB Scale Out
Net Weight: 72020 LB
Net Tons: 36.01

BOL: 11710

Origin	Yards	Material	Billing	Quantity
Not Applicable	0.00 YD	SW CONTAMINATED SOIL	36.01	TN

Driver: 

Weighmaster: 

HOLDENS

Indemnification. Customer agrees, by signature above, to indemnify, hold harmless, and defend Republic Services, Inc., its subsidiaries, affiliates, employees, officers and directors from and against any and all liabilities, claims, penalties, forfeitures, suits and the costs and expenses incident thereto, including costs of defense, settlement, and reasonable attorney's fees, which may be incurred, as a result of death or injuries to any person, or damage to any property, contamination of or adverse effects on the environment, caused in whole or in part by the Customer, its employees, or subcontractors in disposing waste at this Facility. In the event Customer delivers Unacceptable Waste (as determined by Republic) Customer agrees to assume all expenses and obligations with the removal and/or resolution of any effects caused by the delivery of such Unacceptable Waste.

Indemnización. Cliente acuerda indemnizar, mantener inmune, y defender Republic Services, Inc., sus subsidiarios, compañías, divisiones, empleados, oficiales y directores contra de cualquiera y de todas responsabilidades, demandas, penas, pérdidas, juicios, pleitos y los costos incidente además, incluyendo costos de defensa, de acuerdo judicial, y de honorarios razonables del abogado, que pueden ser incurridos en, o como resultado de, la muerte o herida personal a cualquier persona, o daños a cualquier característica, propiedad, contaminación de la tierra o efectos ilícitos en esta Facilidad, causado entero o en parte por el cliente, sus empleados, o sus subcontratistas en botar basura en esta Facilidad. En el caso que el Cliente entrega, bota, basura (según lo determinado por Republic) en este Establecimiento basura inaceptable en los reglamentos de este Establecimiento, el Cliente se compromete asumir todos los costos y obligaciones con el retiro y/o la resolución de cualquier dano(s) causado por la entrega de tal basura inaceptable.



NON-HAZARDOUS WASTE MANIFEST

MANIFEST # 11710

GENERATOR INFORMATION

Generator Name: Tronox LLC
Address: P.O. Box 55
City: Henderson County: Clark
State: NV Zip: 89009
Site Location (if different): 560 W. Lake Mead
Henderson, NV 89015 (702) 592-7727

CUSTOMER/BILLING INFORMATION

Billing Name: NGE LLC c/o Northgate Environment Management
Address: 300 Frank Ogawa Plaza, Ste 510
City: Oakland County: Alameda
State: CA Zip: 94612

Table with 5 columns: Republic Services Approval #, Description of Waste, Volume/Weight, Expiration Date, Container Type. Row 1: 38251011244, Soil for disposal, 36 01/10, 12-31-2011, Tractor with Dump Trailer(s).

*Attach Additional Sheet if necessary

I hereby certify that the above-described materials are non-hazardous wastes as defined by 40 CFR 261 or any applicable state law. Further, that the above named materials are properly classified, described, packaged, marked and labeled, and are in proper condition for transportation according to the applicable regulations of the Department of Transportation.

Susan Crowley (Signature)
Generator/Authorized Agent Name Signature Date Shipped

TRANSPORTER INFORMATION

Transporter Name: Las Vegas Paving DOT # 191949
Address: 4420 S. Decatur Truck Number: K-006
Las Vegas, NV 89103 Phone Number: (702) 353-4355

I certify no hazardous waste or other regulated substance was knowingly introduced to the waste while in my custody. The waste transported in this vehicle is the waste identified above, to the best of my knowledge.

Dorian Mulvey (Signature)
Name of Authorized Agent Signature Date Delivered

DISPOSAL SITE INFORMATION

Site Name: Apex Regional Landfill Phone No. (702) 599-5920
Address: 13550 U.S. Hwy 93 Las Vegas, NV

I hereby acknowledge receipt of the above described materials
Holden, Se... (Signature)
Name (Print or Type) Signature Date Received 03 Oct 10

81 Environmental Tech
13550 N Highway 93
Las Vegas, NV 89165

Ticket Type: INBOUND INVOICE

Ticket Number: 1610
Date: 10/04/2010
Time In: 12:05 am
Time Out: 12:29 am

Customer: 001011 - NGE, LLC c/o Northgate Environ Mgmt

Vehicle/Container: 20915A
Contract: Northgate Env. On Site Soils 3825 11
Comment: 3825 10 11244

Gross Weight: 125,020 LB Manual In
Tare Weight: 53,040 LB Scale Out
Net Weight: 71980 LB
Net Tons: 35.99

BOL: 11712

Origin	Yards	Material	Billing Quantity
Not Applicable	0.00 YD	SW CONTAMINATED SOIL	35.99 TN

Driver:

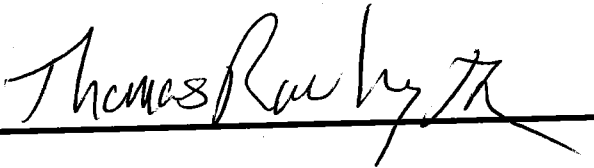

Weighmaster:

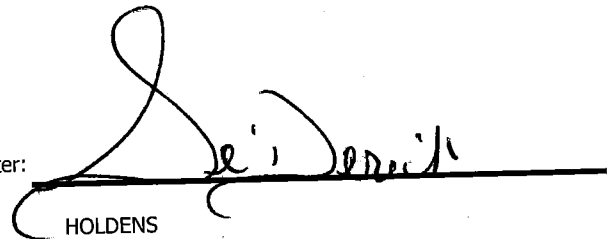

HOLDENS

Indemnification. Customer agrees, by signature above, to indemnify, hold harmless, and defend Republic Services, Inc., its subsidiaries, affiliates, employees, officers and directors from and against any and all liabilities, claims, penalties, forfeitures, suits and the costs and expenses incident thereto, including costs of defense, settlement, and reasonable attorney's fees, which may be incurred, as a result of death or injuries to any person, or damage to any property, contamination of or adverse effects on the environment, caused in whole or in part by the Customer, its employees, or subcontractors in disposing waste at this Facility. In the event Customer delivers Unacceptable Waste (as determined by Republic) Customer agrees to assume all expenses and obligations with the removal and/or resolution of any effects caused by the delivery of such Unacceptable Waste.

Indemnización. Cliente acuerda indemnizar, mantener inmune, y defender Republic Services, Inc., sus subsidiarios, compañías, divisiones, empleados, oficiales y directores contra de cualquiera y de todas responsabilidades, demandas, penas, pérdidas, juicios, pleitos y los costos incidente además, incluyendo costos de defensa, de acuerdo judicial, y de honorarios razonables del abogado, que pueden ser incurridos en, o como resultado de, la muerte o herida personal a cualquier persona, o daños a cualquier característica, propiedad, contaminación de la tierra o efectos ilícitos en esta Facilidad, causado entero o en parte por el cliente, sus empleados, o sus subcontratistas en botar basura en esta Facilidad. En el caso que el Cliente entrega, bota, basura (según lo determinado por Republic) en este Establecimiento basura inaceptable en los reglamentos de este Establecimiento, el Cliente se compromete asumir todos los costos y obligaciones con el retiro y/o la resolución de cualquier dano(s) causado por la entrega de tal basura inaceptable.



NON-HAZARDOUS WASTE MANIFEST

MANIFEST # 11712

GENERATOR INFORMATION

Generator Name: Tronox LLC
Address: P.O. Box 55
City: Henderson County: Clark
State: NV Zip: 89009
Site Location (if different): 560 W. Lake Mead
Henderson, NV 89015 (702) 592-7727

CUSTOMER/BILLING INFORMATION

Billing Name: NGE LLC c/o Northgate Environment Management
Address: 300 Frank Ogawa Plaza, Ste 510
City: Oakland County: Alameda
State: CA Zip: 94612

Table with 5 columns: Republic Services Approval #, Description of Waste, Volume/Weight, Expiration Date, Container Type. Row 1: 38251011244, Soil for disposal, 35 71 tons, 12-31-2011, Tractor with Dump Trailer(s).

*Attach Additional Sheet if necessary

I hereby certify that the above-described materials are non-hazardous wastes as defined by 40 CFR 261 or any applicable state law. Further, that the above named materials are properly classified, described, packaged, marked and labeled, and are in proper condition for transportation according to the applicable regulations of the Department of Transportation.

Susan Crowley (Signature)
Generator/Authorized Agent Name Signature Date Shipped

TRANSPORTER INFORMATION

Transporter Name: Las Vegas Paving DOT # 191949
Address: 4420 S. Decatur Truck Number: 00
Las Vegas, NV 89103 Phone Number: (702) 353-4355

I certify no hazardous waste or other regulated substance was knowingly introduced to the waste while in my custody. The waste transported in this vehicle is the waste identified above, to the best of my knowledge.

Tom Rawling (Signature)
Name of Authorized Agent Signature Date Delivered 10-3-10

DISPOSAL SITE INFORMATION

Site Name: Apex Regional Landfill Phone No. (702) 599-5920
Address: 13550 U.S. Hwy 93 Las Vegas, NV

I hereby acknowledge receipt of the above described materials
Holden, Se' Decali (Signature)
Name (Print or Type) Signature Date Received 03 Oct 10

81 Environmental Tech
13550 N Highway 93
Las Vegas, NV 89165

Ticket Type: INBOUND INVOICE

Ticket Number: 1611
Date: 10/04/2010
Time In: 12:11 am
Time Out: 12:32 am

Customer: 001011 - NGE, LLC c/o Northgate Environ Mgmt

Vehicle/Container: 81494P
Contract: Northgate Env. On Site Soils 3825 11
Comment: 3825 10 11244

Gross Weight: 121,200 LB Manual In
Tare Weight: 51,080 LB Manual Out
Net Weight: 70120 LB
Net Tons: 35.06

BOL: 11714

Origin	Yards	Material	Billing	Quantity
Not Applicable	0.00 YD	SW CONTAMINATED SOIL	35.06	TN

Driver: _____



Weighmaster: _____

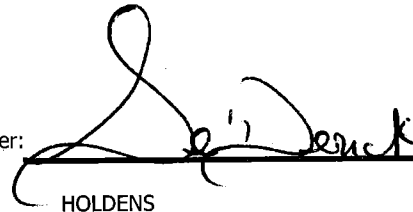

HOLDENS

Indemnification. Customer agrees, by signature above, to indemnify, hold harmless, and defend Republic Services, Inc., its subsidiaries, affiliates, employees, officers and directors from and against any and all liabilities, claims, penalties, forfeitures, suits and the costs and expenses incident thereto, including costs of defense, settlement, and reasonable attorney's fees, which may be incurred, as a result of death or injuries to any person, or damage to any property, contamination of or adverse effects on the environment, caused in whole or in part by the Customer, its employees, or subcontractors in disposing waste at this Facility. In the event Customer delivers Unacceptable Waste (as determined by Republic) Customer agrees to assume all expenses and obligations with the removal and/or resolution of any effects caused by the delivery of such Unacceptable Waste.

Indemnización. Cliente acuerda indemnizar, mantener inmune, y defender Republic Services, Inc., sus subsidiarios, compañías, divisiones, empleados, oficiales y directores contra de cualquiera y de todas responsabilidades, demandas, penas, pérdidas, juicios, pleitos y los costos incidente además, incluyendo costos de defensa, de acuerdo judicial, y de honorarios razonables del abogado, que pueden ser incurridos en, o como resultado de, la muerte o herida personal a cualquier persona, o daños a cualquier característica, propiedad, contaminación de la tierra o efectos ilícitos en esta Facilidad, causado entero o en parte por el cliente, sus empleados, o sus subcontratistas en botar basura en esta Facilidad. En el caso que el Cliente entrega, bota, basura (según lo determinado por Republic) en este Establecimiento basura inaceptable en los reglamentos de este Establecimiento, el Cliente se compromete asumir todos los costos y obligaciones con el retiro y/o la resolución de cualquier dano(s) causado por la entrega de tal basura inaceptable.



NON-HAZARDOUS WASTE MANIFEST

MANIFEST # 11714

GENERATOR INFORMATION

Generator Name: Tronox LLC
Address: P.O. Box 55
City: Henderson County: Clark
State: NV Zip: 89009
Site Location (if different): 560 W. Lake Mead
Henderson, NV 89015 (702) 592-7727

CUSTOMER/BILLING INFORMATION

Billing Name: NGE LLC c/o Northgate Environment Management
Address: 300 Frank Ogawa Plaza, Ste 510
City: Oakland County: Alameda
State: CA Zip: 94612

Table with 5 columns: Republic Services Approval #, Description of Waste, Volume/Weight, Expiration Date, Container Type. Row 1: 38251011244, Soil for disposal, 35.06/ton, 12-31-2011, Tractor with Dump Trailer(s).

*Attach Additional Sheet if necessary

I hereby certify that the above-described materials are non-hazardous wastes as defined by 40 CFR 261 or any applicable state law. Further, that the above named materials are properly classified, described, packaged, marked and labeled, and are in proper condition for transportation according to the applicable regulations of the Department of Transportation.

Susan Crowley (Name)
Susan Crowley (Signature)
Date Shipped

TRANSPORTER INFORMATION

Transporter Name: Las Vegas Paving DOT # 191949
Address: 4420 S. Decatur Truck Number: 125
Las Vegas, NV 89103 Phone Number: (702) 353-4355

I certify no hazardous waste or other regulated substance was knowingly introduced to the waste while in my custody. The waste transported in this vehicle is the waste identified above, to the best of my knowledge.

Calvin Pagayo (Name)
Calvin Pagayo (Signature)
Date Delivered: 10/03/10

DISPOSAL SITE INFORMATION

Site Name: Apex Regional Landfill Phone No. (702) 599-5920
Address: 13550 U.S. Hwy 93 Las Vegas, NV

I hereby acknowledge receipt of the above described materials

Holden Solerelli (Name)
Derrick Holden (Signature)
Date Received: 03 Oct 10

81 Environmental Tech
13550 N Highway 93
Las Vegas, NV 89165

Ticket Type: INBOUND INVOICE

Ticket Number: 1612
Date: 10/04/2010
Time In: 12:15 am
Time Out: 12:37 am

Customer: 001011 - NGE, LLC c/o Northgate Environ Mgmt

Vehicle/Container: 81495P
Contract: Northgate Env. On Site Soils 3825 11
Comment: 3825 10 11244

Gross Weight: 124,440 LB Manual In
Tare Weight: 50,360 LB Manual Out
Net Weight: 74080 LB
Net Tons: 37.04

BOL: 11715

Origin	Yards	Material	Billing	Quantity
Not Applicable	0.00 YD	SW CONTAMINATED SOIL	37.04	TN

Driver: _____

Weighmaster: _____

HOLDENS

Indemnification. Customer agrees, by signature above, to indemnify, hold harmless, and defend Republic Services, Inc., its subsidiaries, affiliates, employees, officers and directors from and against any and all liabilities, claims, penalties, forfeitures, suits and the costs and expenses incident thereto, including costs of defense, settlement, and reasonable attorney's fees, which may be incurred, as a result of death or injuries to any person, or damage to any property, contamination of or adverse effects on the environment, caused in whole or in part by the Customer, its employees, or subcontractors in disposing waste at this Facility. In the event Customer delivers Unacceptable Waste (as determined by Republic) Customer agrees to assume all expenses and obligations with the removal and/or resolution of any effects caused by the delivery of such Unacceptable Waste.

Indemnización. Cliente acuerda indemnizar, mantener inmune, y defender Republic Services, Inc., sus subsidiarios, compañías, divisiones, empleados, oficiales y directores contra de cualquiera y de todas responsabilidades, demandas, penas, pérdidas, juicios, pleitos y los costos incidente además, incluyendo costos de defensa, de acuerdo judicial, y de honorarios razonables del abogado, que pueden ser incurridos en, o como resultado de, la muerte o herida personal a cualquier persona, o daños a cualquier característica, propiedad, contaminación de la tierra o efectos ilícitos en esta Facilidad, causado entero o en parte por el cliente, sus empleados, o sus subcontratistas en botar basura en esta Facilidad. En el caso que el Cliente entrega, bota, basura (según lo determinado por Republic) en este Establecimiento basura inaceptable en los reglamentos de este Establecimiento, el Cliente se compromete asumir todos los costos y obligaciones con el retiro y/o la resolución de cualquier dano(s) causado por la entrega de tal basura inaceptable.



NON-HAZARDOUS WASTE MANIFEST

MANIFEST # 11715

GENERATOR INFORMATION

Generator Name: Tronox LLC
Address: P.O. Box 55
City: Henderson County: Clark
State: NV Zip: 89009
Site Location (if different): 560 W. Lake Mead
Henderson, NV 89015 (702) 592-7727

CUSTOMER/BILLING INFORMATION

Billing Name: NGE LLC c/o Northgate Environment Management
Address: 300 Frank Ogawa Plaza, Ste 510
City: Oakland County: Alameda
State: CA Zip: 94612

Table with 5 columns: Republic Services Approval #, Description of Waste, Volume/Weight, Expiration Date, Container Type. Row 1: 38251011244, Soil for disposal, 37 cu ton, 12-31-2011, Tractor with Dump Trailer(s).

*Attach Additional Sheet if necessary

I hereby certify that the above-described materials are non-hazardous wastes as defined by 40 CFR 261 or any applicable state law. Further, that the above named materials are properly classified, described, packaged, marked and labeled, and are in proper condition for transportation according to the applicable regulations of the Department of Transportation.

Susan Crowley (Signature)
Generator/Authorized Agent Name Signature Date Shipped

TRANSPORTER INFORMATION

Transporter Name: Las Vegas Paving DOT # 191949
Address: 4420 S. Decatur Truck Number: 175
Las Vegas, NV 89103 Phone Number: (702) 353-4355

I certify no hazardous waste or other regulated substance was knowingly introduced to the waste while in my custody. The waste transported in this vehicle is the waste identified above, to the best of my knowledge.

Andrew Walker (Signature)
Name of Authorized Agent Signature Date Delivered 10-3-10

DISPOSAL SITE INFORMATION

Site Name: Apex Regional Landfill Phone No. (702) 599-5920
Address: 13550 U.S. Hwy 93 Las Vegas, NV

I hereby acknowledge receipt of the above described materials
Holden, Se' Derick (Signature)
Name (Print or Type) Signature Date Received 03 Oct 10

81 Environmental Tech
13550 N Highway 93
Las Vegas, NV 89165

Ticket Type: INBOUND INVOICE

Ticket Number: 1613
Date: 10/04/2010
Time In: 12:17 am
Time Out: 12:38 am

Customer: 001011 - NGE, LLC c/o Northgate Environ Mgmt

Vehicle/Container: 81496P
Contract: Northgate Env. On Site Soils 3825 11
Comment: 3825 10 11244

Gross Weight: 125,660 LB Manual In
Tare Weight: 50,260 LB Manual Out
Net Weight: 75400 LB
Net Tons: 37.70

BOL: 11716

Origin	Yards	Material	Billing Quantity
Not Applicable	0.00 YD	SW CONTAMINATED SOIL	37.70 TN

Driver:

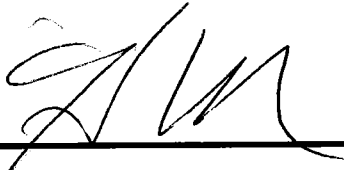

Weighmaster:

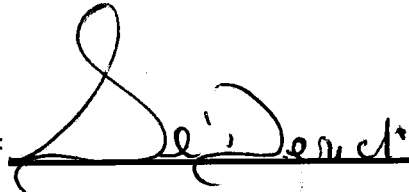

HOLDENS

Indemnification. Customer agrees, by signature above, to indemnify, hold harmless, and defend Republic Services, Inc., its subsidiaries, affiliates, employees, officers and directors from and against any and all liabilities, claims, penalties, forfeitures, suits and the costs and expenses incident thereto, including costs of defense, settlement, and reasonable attorney's fees, which may be incurred, as a result of death or injuries to any person, or damage to any property, contamination of or adverse effects on the environment, caused in whole or in part by the Customer, its employees, or subcontractors in disposing waste at this Facility. In the event Customer delivers Unacceptable Waste (as determined by Republic) Customer agrees to assume all expenses and obligations with the removal and/or resolution of any effects caused by the delivery of such Unacceptable Waste.

Indemnización. Cliente acuerda indemnizar, mantener inmune, y defender Republic Services, Inc., sus subsidiarios, compañías, divisiones, empleados, oficiales y directores contra de cualquiera y de todas responsabilidades, demandas, penas, pérdidas, juicios, pleitos y los costos incidente además, incluyendo costos de defensa, de acuerdo judicial, y de honorarios razonables del abogado, que pueden ser incurridos en, o como resultado de, la muerte o herida personal a cualquier persona, o daños a cualquier característica, propiedad, contaminación de la tierra o efectos ilícitos en esta Facilidad, causado entero o en parte por el cliente, sus empleados, o sus subcontratistas en botar basura en esta Facilidad. En el caso que el Cliente entrega, bota, basura (según lo determinado por Republic) en este Establecimiento basura inaceptable en los reglamentos de este Establecimiento, el Cliente se compromete asumir todos los costos y obligaciones con el retiro y/o la resolución de cualquier dano(s) causado por la entrega de tal basura inaceptable.



NON-HAZARDOUS WASTE MANIFEST

MANIFEST # 11716

GENERATOR INFORMATION

Generator Name: Tronox LLC

Address: P.O. Box 55

City: Henderson County: Clark

State: NV Zip: 89009

Site Location (if different): 560 W. Lake Mead
Henderson, NV 89015 (702) 592-7727

CUSTOMER/BILLING INFORMATION

Billing Name: NGE LLC c/o Northgate Environment Management

Address: 300 Frank Ogawa Plaza, Ste 510

City: Oakland County: Alameda

State: CA Zip: 94612

Table with 5 columns: Republic Services Approval #, Description of Waste, Volume/Weight, Expiration Date, Container Type. Row 1: 38251011244, Soil for disposal, 37 10/100, 12-31-2011, Tractor with Dump Trailer(s).

*Attach Additional Sheet if necessary

I hereby certify that the above-described materials are non-hazardous wastes as defined by 40 CFR 261 or any applicable state law. Further, that the above named materials are properly classified, described, packaged, marked and labeled, and are in proper condition for transportation according to the applicable regulations of the Department of Transportation.

Susan Crowley (Signature)
Generator/Authorized Agent Name Signature Date Shipped

TRANSPORTER INFORMATION

Transporter Name: Las Vegas Paving

DOT # 191949

Address: 4420 S. Decatur

Truck Number: 145

Las Vegas, NV 89103

Phone Number: (702) 353-4355

I certify no hazardous waste or other regulated substance was knowingly introduced to the waste while in my custody. The waste transported in this vehicle is the waste identified above, to the best of my knowledge.

Harry McEld (Signature)
Name of Authorized Agent Signature Date Delivered 10-3-10

DISPOSAL SITE INFORMATION

Site Name: Apex Regional Landfill

Phone No. (702) 599-5920

Address: 13550 U.S. Hwy 93 Las Vegas, NV

I hereby acknowledge receipt of the above described materials
Holden, Se' Derrick (Signature)
Name (Print or Type) Signature Date Received 03 Oct 10

81 Environmental Tech
13550 N Highway 93
Las Vegas, NV 89165

Ticket Type: INBOUND INVOICE

Ticket Number: 1614
Date: 10/04/2010
Time In: 12:19 am
Time Out: 12:40 am

Customer: 001011 - NGE, LLC c/o Northgate Environ Mgmt

Vehicle/Container: 82418P
Contract: Northgate Env. On Site Soils 3825 11
Comment: 3825 10 11244

Gross Weight: 137,620 LB Manual In
Tare Weight: 67,700 LB Scale Out
Net Weight: 69920 LB
Net Tons: 34.96

BOL: 11717

Origin	Yards	Material	Billing Quantity
Not Applicable	0.00 YD	SW CONTAMINATED SOIL	34.96 TN

Driver:

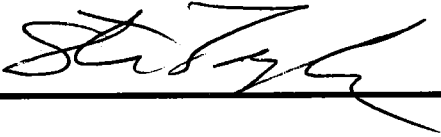

Weighmaster:

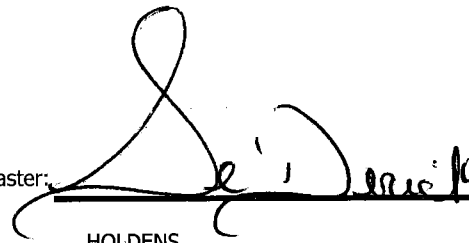

HOLDENS

Indemnification. Customer agrees, by signature above, to indemnify, hold harmless, and defend Republic Services, Inc., its subsidiaries, affiliates, employees, officers and directors from and against any and all liabilities, claims, penalties, forfeitures, suits and the costs and expenses incident thereto, including costs of defense, settlement, and reasonable attorney's fees, which may be incurred, as a result of death or injuries to any person, or damage to any property, contamination of or adverse effects on the environment, caused in whole or in part by the Customer, its employees, or subcontractors in disposing waste at this Facility. In the event Customer delivers Unacceptable Waste (as determined by Republic) Customer agrees to assume all expenses and obligations with the removal and/or resolution of any effects caused by the delivery of such Unacceptable Waste.

Indemnización. Cliente acuerda indemnizar, mantener inmune, y defender Republic Services, Inc., sus subsidiarios, compañías, divisiones, empleados, oficiales y directores contra de cualquiera y de todas responsabilidades, demandas, penas, pérdidas, juicios, pleitos y los costos incidente además, incluyendo costos de defensa, de acuerdo judicial, y de honorarios razonables del abogado, que pueden ser incurridos en, o como resultado de, la muerte o herida personal a cualquier persona, o daños a cualquier característica, propiedad, contaminación de la tierra o efectos ilícitos en esta Facilidad, causado entero o en parte por el cliente, sus empleados, o sus subcontratistas en botar basura en esta Facilidad. En el caso que el Cliente entrega, bota, basura (según lo determinado por Republic) en este Establecimiento basura inaceptable en los reglamentos de este Establecimiento, el Cliente se compromete asumir todos los costos y obligaciones con el retiro y/o la resolución de cualquier dano(s) causado por la entrega de tal basura inaceptable.



NON-HAZARDOUS WASTE MANIFEST

MANIFEST # 11717

GENERATOR INFORMATION

Generator Name: Tronox LLC

Address: P.O. Box 55

City: Henderson County: Clark

State: NV Zip: 89009

Site Location (if different): 560 W. Lake Mead
Henderson, NV 89015 (702) 592-7727

CUSTOMER/BILLING INFORMATION

Billing Name: NGE LLC c/o Northgate Environment Management

Address: 300 Frank Ogawa Plaza, Ste 510

City: Oakland County: Alameda

State: CA Zip: 94612

Table with 5 columns: Republic Services Approval #, Description of Waste, Volume/Weight, Expiration Date, Container Type. Row 1: 38251011244, Soil for disposal, 34 96/100, 12-31-2011, Tractor with Dump Trailer(s).

*Attach Additional Sheet if necessary

I hereby certify that the above-described materials are non-hazardous wastes as defined by 40 CFR 261 or any applicable state law. Further, that the above named materials are properly classified, described, packaged, marked and labeled, and are in proper condition for transportation according to the applicable regulations of the Department of Transportation.

Susan Crowley (Signature)
Generator/Authorized Agent Name Signature Date Shipped

TRANSPORTER INFORMATION

Transporter Name: Las Vegas Paving

DOT # 191949

Address: 4420 S. Decatur

Truck Number: 220

Las Vegas, NV 89103

Phone Number: (702) 353-4355

I certify no hazardous waste or other regulated substance was knowingly introduced to the waste while in my custody. The waste transported in this vehicle is the waste identified above, to the best of my knowledge.

STEVE TAYLOR (Signature)
Name of Authorized Agent Signature Date Delivered 10-3-10

DISPOSAL SITE INFORMATION

Site Name: Apex Regional Landfill

Phone No. (702) 599-5920

Address: 13550 U.S. Hwy 93 Las Vegas, NV

I hereby acknowledge receipt of the above described materials
Holden, Se' Derrick (Signature)
Name (Print or Type) Signature Date Received 03 Oct 10

81 Environmental Tech
13550 N Highway 93
Las Vegas, NV 89165

Ticket Type: INBOUND INVOICE

Ticket Number: 1615
Date: 10/04/2010
Time In: 12:25 am
Time Out: 12:51 am

Customer: 001011 - NGE, LLC c/o Northgate Environ Mgmt

Vehicle/Container: 192460
Contract: Northgate Env. On Site Soils 3825 11
Comment: 3825 10 11244

Gross Weight: 125,920 LB Manual In
Tare Weight: 52,940 LB Scale Out
Net Weight: 72980 LB
Net Tons: 36.49

BOL: 11718

Origin	Yards	Material	Billing Quantity
Not Applicable	0.00 YD	SW CONTAMINATED SOIL	36.49 TN

Driver:

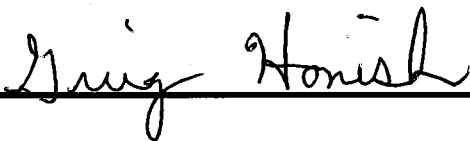

Weighmaster:

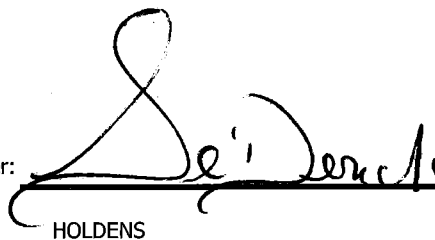
HOLDENS

Indemnification. Customer agrees, by signature above, to indemnify, hold harmless, and defend Republic Services, Inc., its subsidiaries, affiliates, employees, officers and directors from and against any and all liabilities, claims, penalties, forfeitures, suits and the costs and expenses incident thereto, including costs of defense, settlement, and reasonable attorney's fees, which may be incurred, as a result of death or injuries to any person, or damage to any property, contamination of or adverse effects on the environment, caused in whole or in part by the Customer, its employees, or subcontractors in disposing waste at this Facility. In the event Customer delivers Unacceptable Waste (as determined by Republic) Customer agrees to assume all expenses and obligations with the removal and/or resolution of any effects caused by the delivery of such Unacceptable Waste.

Indemnización. Cliente acuerda indemnizar, mantener inmune, y defender Republic Services, Inc., sus subsidiarios, compañías, divisiones, empleados, oficiales y directores contra de cualquiera y de todas responsabilidades, demandas, penas, pérdidas, juicios, pleitos y los costos incidente además, incluyendo costos de defensa, de acuerdo judicial, y de honorarios razonables del abogado, que pueden ser incurridos en, o como resultado de, la muerte o herida personal a cualquier persona, o daños a cualquier característica, propiedad, contaminación de la tierra o efectos ilícitos en esta Facilidad, causado entero o en parte por el cliente, sus empleados, o sus subcontratistas en botar basura en esta Facilidad. En el caso que el Cliente entrega, bota, basura (según lo determinado por Republic) en este Establecimiento basura inaceptable en los reglamentos de este Establecimiento, el Cliente se compromete asumir todos los costos y obligaciones con el retiro y/o la resolución de cualquier dano(s) causado por la entrega de tal basura inaceptable.



NON-HAZARDOUS WASTE MANIFEST

MANIFEST # 11718

GENERATOR INFORMATION

Generator Name: Tronox LLC
 Address: P.O. Box 55
 City: Henderson County: Clark
 State: NV Zip: 89009
 Site Location (if different): 560 W. Lake Mead
Henderson, NV 89015 (702) 592-7727

CUSTOMER/BILLING INFORMATION

Billing Name: NGE LLC c/o Northgate Environment Management
 Address: 300 Frank Ogawa Plaza, Ste 510
 City: Oakland County: Alameda
 State: CA Zip: 94612

Republic Services Approval #	Description of Waste	Volume/Weight	Expiration Date	Container Type
38251011244	Soil for disposal	36 ⁴⁹ / ₁₀₇	12-31-2011	Tractor with Dump Trailer(s)
	RZ- _____ # _____			

*Attach Additional Sheet if necessary

I hereby certify that the above-described materials are non-hazardous wastes as defined by 40 CFR 261 or any applicable state law. Further, that the above named materials are properly classified, described, packaged, marked and labeled, and are in proper condition for transportation according to the applicable regulations of the Department of Transportation.

Susan Crowley [Signature] _____
 Generator/Authorized Agent Name Signature Date Shipped

TRANSPORTER INFORMATION

Transporter Name: Las Vegas Paving DOT # 191949
 Address: 4420 S. Decatur Truck Number: 2460
Las Vegas, NV 89103 Phone Number: (702) 353-4355

I certify no hazardous waste or other regulated substance was knowingly introduced to the waste while in my custody. The waste transported in this vehicle is the waste identified above, to the best of my knowledge.

Greg Honish [Signature] 10-3-10
 Name of Authorized Agent Signature Date Delivered

DISPOSAL SITE INFORMATION

Site Name: Apex Regional Landfill Phone No. (702) 599-5920
 Address: 13550 U.S. Hwy 93 Las Vegas, NV

I hereby acknowledge receipt of the above described materials
Holden, Se Derrick [Signature] 09 Oct 10
 Name (Print or Type) Signature Date Received

81 Environmental Tech
13550 N Highway 93
Las Vegas, NV 89165

Ticket Type: INBOUND INVOICE

Ticket Number: 1616
Date: 10/04/2010
Time In: 12:28 am
Time Out: 12:52 am

Customer: 001011 - NGE, LLC c/o Northgate Environ Mgmt

Vehicle/Container: 192457
Contract: Northgate Env. On Site Soils 3825 11
Comment: 3825 10 11244

Gross Weight: 122,520 LB Manual In
Tare Weight: 52,260 LB Manual Out
Net Weight: 70260 LB
Net Tons: 35.13

BOL: 11719

Origin	Yards	Material	Billing	Quantity
Not Applicable	0.00 YD	SW CONTAMINATED SOIL	35.13	TN

Driver:

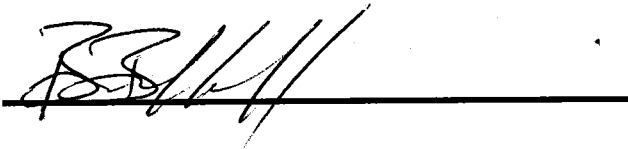

Weighmaster:

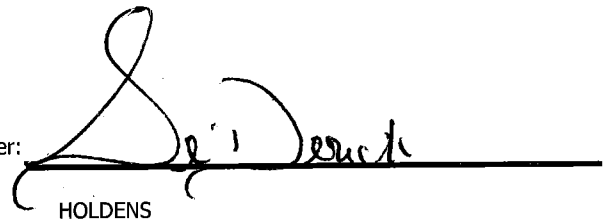

HOLDENS

Indemnification. Customer agrees, by signature above, to indemnify, hold harmless, and defend Republic Services, Inc., its subsidiaries, affiliates, employees, officers and directors from and against any and all liabilities, claims, penalties, forfeitures, suits and the costs and expenses incident thereto, including costs of defense, settlement, and reasonable attorney's fees, which may be incurred, as a result of death or injuries to any person, or damage to any property, contamination of or adverse effects on the environment, caused in whole or in part by the Customer, its employees, or subcontractors in disposing waste at this Facility. In the event Customer delivers Unacceptable Waste (as determined by Republic) Customer agrees to assume all expenses and obligations with the removal and/or resolution of any effects caused by the delivery of such Unacceptable Waste.

Indemnización. Cliente acuerda indemnizar, mantener inmune, y defender Republic Services, Inc., sus subsidiarios, compañías, divisiones, empleados, oficiales y directores contra de cualquiera y de todas responsabilidades, demandas, penas, pérdidas, juicios, pleitos y los costos incidente además, incluyendo costos de defensa, de acuerdo judicial, y de honorarios razonables del abogado, que pueden ser incurridos en, o como resultado de, la muerte o herida personal a cualquier persona, o daños a cualquier característica, propiedad, contaminación de la tierra o efectos ilícitos en esta Facilidad, causado entero o en parte por el cliente, sus empleados, o sus subcontratistas en botar basura en esta Facilidad. En el caso que el Cliente entrega, bota, basura (según lo determinado por Republic) en este Establecimiento basura inaceptable en los reglamentos de este Establecimiento, el Cliente se compromete asumir todos los costos y obligaciones con el retiro y/o la resolución de cualquier dano(s) causado por la entrega de tal basura inaceptable.



NON-HAZARDOUS WASTE MANIFEST

MANIFEST # 11719

GENERATOR INFORMATION

Generator Name: Tronox LLC

Address: P.O. Box 55

City: Henderson County: Clark

State: NV Zip: 89009

Site Location (if different): 560 W. Lake Mead

Henderson, NV 89015 (702) 592-7727

CUSTOMER/BILLING INFORMATION

Billing Name: NGE LLC c/o Northgate Environment Management

Address: 300 Frank Ogawa Plaza, Ste 510

City: Oakland County: Alameda

State: CA Zip: 94612

Table with 5 columns: Republic Services Approval #, Description of Waste, Volume/Weight, Expiration Date, Container Type. Row 1: 38251011244, Soil for disposal, 35 1/2 tons, 12-31-2011, Tractor with Dump Trailer(s).

*Attach Additional Sheet if necessary

I hereby certify that the above-described materials are non-hazardous wastes as defined by 40 CFR 261 or any applicable state law. Further, that the above named materials are properly classified, described, packaged, marked and labeled, and are in proper condition for transportation according to the applicable regulations of the Department of Transportation.

Susan Crowley (Name), Tom Crowley (Signature), Date Shipped

TRANSPORTER INFORMATION

Transporter Name: Las Vegas Paving

DOT # 191949

Address: 4420 S. Decatur

Truck Number: 192457

Las Vegas, NV 89103

Phone Number: (702) 353-4355

I certify no hazardous waste or other regulated substance was knowingly introduced to the waste while in my custody. The waste transported in this vehicle is the waste identified above, to the best of my knowledge.

Brian Brinkerhoff (Name), Signature, 10-3-10 (Date Delivered)

DISPOSAL SITE INFORMATION

Site Name: Apex Regional Landfill

Phone No. (702) 599-5920

Address: 13550 U.S. Hwy 93 Las Vegas, NV

I hereby acknowledge receipt of the above described materials. Holden, S. J. (Name), Signature, 04 Oct 10 (Date Received)

81 Environmental Tech
13550 N Highway 93
Las Vegas, NV 89165

Ticket Type: INBOUND INVOICE

Ticket Number: 1617
Date: 10/04/2010
Time In: 12:32 am
Time Out: 12:55 am

Customer: 001011 - NGE, LLC c/o Northgate Environ Mgmt

Vehicle/Container: 192456
Contract: Northgate Env. On Site Soils 3825 11
Comment: 3825 10 11244

Gross Weight: 125,820 LB Manual In
Tare Weight: 54,480 LB Scale Out
Net Weight: 71340 LB
Net Tons: 35.67

BOL: 11720

Origin	Yards	Material	Billing Quantity
Not Applicable	0.00 YD	SW CONTAMINATED SOIL	35.67 TN

Driver: _____

Weighmaster: _____

HOLDENS

Indemnification. Customer agrees, by signature above, to indemnify, hold harmless, and defend Republic Services, Inc., its subsidiaries, affiliates, employees, officers and directors from and against any and all liabilities, claims, penalties, forfeitures, suits and the costs and expenses incident thereto, including costs of defense, settlement, and reasonable attorney's fees, which may be incurred, as a result of death or injuries to any person, or damage to any property, contamination of or adverse effects on the environment, caused in whole or in part by the Customer, its employees, or subcontractors in disposing waste at this Facility. In the event Customer delivers Unacceptable Waste (as determined by Republic) Customer agrees to assume all expenses and obligations with the removal and/or resolution of any effects caused by the delivery of such Unacceptable Waste.

Indemnización. Cliente acuerda indemnizar, mantener inmune, y defender Republic Services, Inc., sus subsidiarios, compañías, divisiones, empleados, oficiales y directores contra de cualquiera y de todas responsabilidades, demandas, penas, pérdidas, juicios, pleitos y los costos incidente además, incluyendo costos de defensa, de acuerdo judicial, y de honorarios razonables del abogado, que pueden ser incurridos en, o como resultado de, la muerte o herida personal a cualquier persona, o daños a cualquier característica, propiedad, contaminación de la tierra o efectos ilícitos en esta Facilidad, causado entero o en parte por el cliente, sus empleados, o sus subcontratistas en botar basura en esta Facilidad. En el caso que el Cliente entrega, bota, basura (según lo determinado por Republic) en este Establecimiento basura inaceptable en los reglamentos de este Establecimiento, el Cliente se compromete asumir todos los costos y obligaciones con el retiro y/o la resolución de cualquier dano(s) causado por la entrega de tal basura inaceptable.



NON-HAZARDOUS WASTE MANIFEST

MANIFEST # 11720

GENERATOR INFORMATION

Generator Name: Tronox LLC

Address: P.O. Box 55

City: Henderson County: Clark

State: NV Zip: 89009

Site Location (if different): 560 W. Lake Mead

Henderson, NV 89015 (702) 592-7727

CUSTOMER/BILLING INFORMATION

Billing Name: NGE LLC c/o Northgate Environment Management

Address: 300 Frank Ogawa Plaza, Ste 510

City: Oakland County: Alameda

State: CA Zip: 94612

Table with 5 columns: Republic Services Approval #, Description of Waste, Volume/Weight, Expiration Date, Container Type. Row 1: 38251011244, Soil for disposal, 35 6 7/10 ton, 12-31-2011, Tractor with Dump Trailer(s). Row 2: RZ- #

*Attach Additional Sheet if necessary

I hereby certify that the above-described materials are non-hazardous wastes as defined by 40 CFR 261 or any applicable state law. Further, that the above named materials are properly classified, described, packaged, marked and labeled, and are in proper condition for transportation according to the applicable regulations of the Department of Transportation.

Susan Crowley (Signature: Susan Crowley) Generator/Authorized Agent Name Signature Date Shipped

TRANSPORTER INFORMATION

Transporter Name: Las Vegas Paving

DOT # 191949

Address: 4420 S. Decatur

Truck Number: P245C

Las Vegas, NV 89103

Phone Number: (702) 353-4355

I certify no hazardous waste or other regulated substance was knowingly introduced to the waste while in my custody. The waste transported in this vehicle is the waste identified above, to the best of my knowledge

Blec (Signature: Blec) Name of Authorized Agent Signature Date Delivered 10/3/10

DISPOSAL SITE INFORMATION

Site Name: Apex Regional Landfill

Phone No. (702) 599-5920

Address: 13550 U.S. Hwy 93 Las Vegas, NV

I hereby acknowledge receipt of the above described materials

Holden, Se... (Signature: Se... Holden) Name (Print or Type) Signature Date Received 09/02/10

81 Environmental Tech
13550 N Highway 93
Las Vegas, NV 89165

Ticket Type: INBOUND INVOICE

Ticket Number: 1618
Date: 10/04/2010
Time In: 12:36 am
Time Out: 1:01 am

Customer: 001011 - NGE, LLC c/o Northgate Environ Mgmt

Vehicle/Container: 81460P

Contract: Northgate Env. On Site Soils 3825 11

Comment: ~~AA27~~ 3825 1011244

Gross Weight: 124,960 LB Manual In
Tare Weight: 52,420 LB Scale Out
Net Weight: 72,540 LB
Net Tons: 36.27

BOL: 11721

Origin	Yards	Material	Billing Quantity
Not Applicable	0.00 YD	SW CONTAMINATED SOIL	36.27 TN

Driver: _____

Weighmaster: _____

HOLDENS

Indemnification. Customer agrees, by signature above, to indemnify, hold harmless, and defend Republic Services, Inc., its subsidiaries, affiliates, employees, officers and directors from and against any and all liabilities, claims, penalties, forfeitures, suits and the costs and expenses incident thereto, including costs of defense, settlement, and reasonable attorney's fees, which may be incurred, as a result of death or injuries to any person, or damage to any property, contamination of or adverse effects on the environment, caused in whole or in part by the Customer, its employees, or subcontractors in disposing waste at this Facility. In the event Customer delivers Unacceptable Waste (as determined by Republic) Customer agrees to assume all expenses and obligations with the removal and/or resolution of any effects caused by the delivery of such Unacceptable Waste.

Indemnización. Cliente acuerda indemnizar, mantener inmune, y defender Republic Services, Inc., sus subsidiarios, compañías, divisiones, empleados, oficiales y directores contra de cualquiera y de todas responsabilidades, demandas, penas, pérdidas, juicios, pleitos y los costos incidente además, incluyendo costos de defensa, de acuerdo judicial, y de honorarios razonables del abogado, que pueden ser incurridos en, o como resultado de, la muerte o herida personal a cualquier persona, o daños a cualquier característica, propiedad, contaminación de la tierra o efectos ilícitos en esta Facilidad, causado entero o en parte por el cliente, sus empleados, o sus subcontratistas en botar basura en esta Facilidad. En el caso que el Cliente entrega, bota, basura (según lo determinado por Republic) en este Establecimiento basura inaceptable en los reglamentos de este Establecimiento, el Cliente se compromete asumir todos los costos y obligaciones con el retiro y/o la resolución de cualquier dano(s) causado por la entrega de tal basura inaceptable.



NON-HAZARDOUS WASTE MANIFEST

MANIFEST # 11721

GENERATOR INFORMATION

Generator Name: Tronox LLC
Address: P.O. Box 55
City: Henderson County: Clark
State: NV Zip: 89009
Site Location (if different): 560 W. Lake Mead
Henderson, NV 89015 (702) 592-7727

CUSTOMER/BILLING INFORMATION

Billing Name: NGE LLC c/o Northgate Environment Management
Address: 300 Frank Ogawa Plaza, Ste 510
City: Oakland County: Alameda
State: CA Zip: 94612

Table with 5 columns: Republic Services Approval #, Description of Waste, Volume/Weight, Expiration Date, Container Type. Row 1: 38251011244, Soil for disposal, 36 27 ton, 12-31-2011, Tractor with Dump Trailer(s).

*Attach Additional Sheet if necessary

I hereby certify that the above-described materials are non-hazardous wastes as defined by 40 CFR 261 or any applicable state law. Further, that the above named materials are properly classified, described, packaged, marked and labeled, and are in proper condition for transportation according to the applicable regulations of the Department of Transportation.

Susan Crowley
Generator/Authorized Agent Name Signature Date Shipped

TRANSPORTER INFORMATION

Transporter Name: Las Vegas Paving DOT # 191949
Address: 4420 S. Decatur Truck Number: 27
Las Vegas, NV 89103 Phone Number: (702) 353-4355

I certify no hazardous waste or other regulated substance was knowingly introduced to the waste while in my custody. The waste transported in this vehicle is the waste identified above, to the best of my knowledge.

DANIEL GARDENAS
Name of Authorized Agent Signature Date Delivered 10-3-2010

DISPOSAL SITE INFORMATION

Site Name: Apex Regional Landfill Phone No. (702) 599-5920
Address: 13550 U.S. Hwy 93 Las Vegas, NV

I hereby acknowledge receipt of the above described materials
Name (Print or Type) Signature Date Received 04 Oct 10

81 Environmental Tech
13550 N Highway 93
Las Vegas, NV 89165

Ticket Type: INBOUND INVOICE

Ticket Number: 1619
Date: 10/04/2010
Time In: 12:07 am
Time Out: 1:03 am

Customer: 001011 - NGE, LLC c/o Northgate Environ Mgmt

Vehicle/Container: 43099A
Contract: Northgate Env. On Site Soils 3825 11
Comment: 3825 10 11244

Gross Weight: 126,520 LB Manual In
Tare Weight: 54,480 LB Manual Out
Net Weight: 72040 LB
Net Tons: 36.02

BOL: 11713

Origin	Yards	Material	Billing Quantity
Not Applicable	0.00 YD	SW CONTAMINATED SOIL	36.02 TN

Driver: 

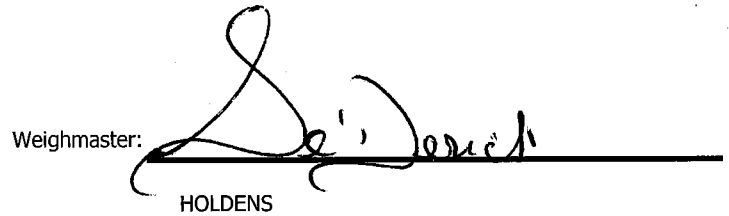
Weighmaster: 
HOLDENS

Indemnification. Customer agrees, by signature above, to indemnify, hold harmless, and defend Republic Services, Inc., its subsidiaries, affiliates, employees, officers and directors from and against any and all liabilities, claims, penalties, forfeitures, suits and the costs and expenses incident thereto, including costs of defense, settlement, and reasonable attorney's fees, which may be incurred, as a result of death or injuries to any person, or damage to any property, contamination of or adverse effects on the environment, caused in whole or in part by the Customer, its employees, or subcontractors in disposing waste at this Facility. In the event Customer delivers Unacceptable Waste (as determined by Republic) Customer agrees to assume all expenses and obligations with the removal and/or resolution of any effects caused by the delivery of such Unacceptable Waste.

Indemnización. Cliente acuerda indemnizar, mantener inmune, y defender Republic Services, Inc., sus subsidiarios, compañías, divisiones, empleados, oficiales y directores contra de cualquiera y de todas responsabilidades, demandas, penas, pérdidas, juicios, pleitos y los costos incidente además, incluyendo costos de defensa, de acuerdo judicial, y de honorarios razonables del abogado, que pueden ser incurridos en, o como resultado de, la muerte o herida personal a cualquier persona, o daños a cualquier característica, propiedad, contaminación de la tierra o efectos ilícitos en esta Facilidad, causado entero o en parte por el cliente, sus empleados, o sus subcontratistas en botar basura en esta Facilidad. En el caso que el Cliente entrega, bota, basura (según lo determinado por Republic) en este Establecimiento basura inaceptable en los reglamentos de este Establecimiento, el Cliente se compromete asumir todos los costos y obligaciones con el retiro y/o la resolución de cualquier dano(s) causado por la entrega de tal basura inaceptable.



NON-HAZARDOUS WASTE MANIFEST

MANIFEST # 11713

GENERATOR INFORMATION

Generator Name: Tronox LLC

Address: P.O. Box 55

City: Henderson County: Clark

State: NV Zip: 89009

Site Location (if different): 560 W. Lake Mead
Henderson, NV 89015 (702) 592-7727

CUSTOMER/BILLING INFORMATION

Billing Name: NGE LLC c/o Northgate Environment Management

Address: 300 Frank Ogawa Plaza, Ste 510

City: Oakland County: Alameda

State: CA Zip: 94612

Table with 5 columns: Republic Services Approval #, Description of Waste, Volume/Weight, Expiration Date, Container Type. Row 1: 38251011244, Soil for disposal, 36 ton, 12-31-2011, Tractor with Dump Trailer(s).

*Attach Additional Sheet if necessary

I hereby certify that the above-described materials are non-hazardous wastes as defined by 40 CFR 261 or any applicable state law. Further, that the above named materials are properly classified, described, packaged, marked and labeled, and are in proper condition for transportation according to the applicable regulations of the Department of Transportation.

Susan Crowley (Signature)
Generator/Authorized Agent Name Signature Date Shipped

TRANSPORTER INFORMATION

Transporter Name: Las Vegas Paving

DOT # 191949

Address: 4420 S. Decatur

Truck Number: (Signature)

Las Vegas, NV 89103

Phone Number: (702) 353-4355

I certify no hazardous waste or other regulated substance was knowingly introduced to the waste while in my custody. The waste transported in this vehicle is the waste identified above, to the best of my knowledge.

(Signature)
Name of Authorized Agent Signature Date Delivered 10/3/10

DISPOSAL SITE INFORMATION

Site Name: Apex Regional Landfill

Phone No. (702) 599-5920

Address: 13550 U.S. Hwy 93 Las Vegas, NV

I hereby acknowledge receipt of the above described materials

Holden, Se'Derick (Signature)
Name (Print or Type) Signature Date Received 03 Oct 10

81 Environmental Tech
13550 N Highway 93
Las Vegas, NV 89165

Ticket Type: INBOUND INVOICE

Ticket Number: 1620
Date: 10/04/2010
Time In: 12:41 am
Time Out: 1:04 am

Customer: 001011 - NGE, LLC c/o Northgate Environ Mgmt

Vehicle/Container: 86053P
Contract: Northgate Env. On Site Soils 3825 11
Comment: 3825 10 11244

Gross Weight: 128,960 LB Manual In
Tare Weight: 56,880 LB Scale Out
Net Weight: 72080 LB
Net Tons: 36.04

BOL: 11722

Origin	Yards	Material	Billing	Quantity
Not Applicable	0.00 YD	SW CONTAMINATED SOIL	36.04	TN

Driver:



Weighmaster:

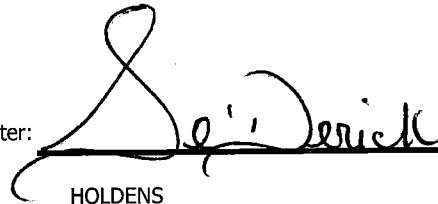

HOLDENS

Indemnification. Customer agrees, by signature above, to indemnify, hold harmless, and defend Republic Services, Inc., its subsidiaries, affiliates, employees, officers and directors from and against any and all liabilities, claims, penalties, forfeitures, suits and the costs and expenses incident thereto, including costs of defense, settlement, and reasonable attorney's fees, which may be incurred, as a result of death or injuries to any person, or damage to any property, contamination of or adverse effects on the environment, caused in whole or in part by the Customer, its employees, or subcontractors in disposing waste at this Facility. In the event Customer delivers Unacceptable Waste (as determined by Republic) Customer agrees to assume all expenses and obligations with the removal and/or resolution of any effects caused by the delivery of such Unacceptable Waste.

Indemnización. Cliente acuerda indemnizar, mantener inmune, y defender Republic Services, Inc., sus subsidiarios, compañías, divisiones, empleados, oficiales y directores contra de cualquiera y de todas responsabilidades, demandas, penas, pérdidas, juicios, pleitos y los costos incidente además, incluyendo costos de defensa, de acuerdo judicial, y de honorarios razonables del abogado, que pueden ser incurridos en, o como resultado de, la muerte o herida personal a cualquier persona, o daños a cualquier característica, propiedad, contaminación de la tierra o efectos ilícitos en esta Facilidad, causado entero o en parte por el cliente, sus empleados, o sus subcontratistas en botar basura en esta Facilidad. En el caso que el Cliente entrega, bota, basura (según lo determinado por Republic) en este Establecimiento basura inaceptable en los reglamentos de este Establecimiento, el Cliente se compromete asumir todos los costos y obligaciones con el retiro y/o la resolución de cualquier dano(s) causado por la entrega de tal basura inaceptable.



NON-HAZARDOUS WASTE MANIFEST

MANIFEST # 11722

GENERATOR INFORMATION

Generator Name: Tronox LLC
Address: P.O. Box 55
City: Henderson County: Clark
State: NV Zip: 89009
Site Location (if different): 560 W. Lake Mead
Henderson, NV 89015 (702) 592-7727

CUSTOMER/BILLING INFORMATION

Billing Name: NGE LLC c/o Northgate Environment Management
Address: 300 Frank Ogawa Plaza, Ste 510
City: Oakland County: Alameda
State: CA Zip: 94612

Table with 5 columns: Republic Services Approval #, Description of Waste, Volume/Weight, Expiration Date, Container Type. Row 1: 38251011244, Soil for disposal, 36 04/107, 12-31-2011, Tractor with Dump Trailer(s).

*Attach Additional Sheet if necessary

I hereby certify that the above-described materials are non-hazardous wastes as defined by 40 CFR 261 or any applicable state law. Further, that the above named materials are properly classified, described, packaged, marked and labeled, and are in proper condition for transportation according to the applicable regulations of the Department of Transportation.

Susan Crowley
Generator/Authorized Agent Name Signature Date Shipped

TRANSPORTER INFORMATION

Transporter Name: Las Vegas Paving DOT # 191949
Address: 4420 S. Decatur Truck Number: 261
Las Vegas, NV 89103 Phone Number: (702) 353-4355

I certify no hazardous waste or other regulated substance was knowingly introduced to the waste while in my custody. The waste transported in this vehicle is the waste identified above, to the best of my knowledge.

Name of Authorized Agent Signature Date Delivered

DISPOSAL SITE INFORMATION

Site Name: Apex Regional Landfill Phone No. (702) 599-5920
Address: 13550 U.S. Hwy 93 Las Vegas, NV

I hereby acknowledge receipt of the above described materials
Holden, Se'Derrick Signature Date Received 04/04/10

81 Environmental Tech
13550 N Highway 93
Las Vegas, NV 89165

Ticket Type: INBOUND INVOICE

Ticket Number: 1621
Date: 10/04/2010
Time In: 12:42 am
Time Out: 1:06 am

Customer: 001011 - NGE, LLC c/o Northgate Environ Mgmt

Vehicle/Container: 76811P
Contract: Northgate Env. On Site Soils 3825 11
Comment: ~~242-3805~~ 10 11244

Gross Weight: 127,400 LB Manual In
Tare Weight: 53,660 LB Manual Out
Net Weight: 73740 LB
Net Tons: 36.87

BOL: 11723

Origin	Yards	Material	Billing	Quantity
Not Applicable	0.00 YD	SW CONTAMINATED SOIL	36.87	TN

Driver: _____

Weighmaster: _____

HOLDENS

Indemnification. Customer agrees, by signature above, to indemnify, hold harmless, and defend Republic Services, Inc., its subsidiaries, affiliates, employees, officers and directors from and against any and all liabilities, claims, penalties, forfeitures, suits and the costs and expenses incident thereto, including costs of defense, settlement, and reasonable attorney's fees, which may be incurred, as a result of death or injuries to any person, or damage to any property, contamination of or adverse effects on the environment, caused in whole or in part by the Customer, its employees, or subcontractors in disposing waste at this Facility. In the event Customer delivers Unacceptable Waste (as determined by Republic) Customer agrees to assume all expenses and obligations with the removal and/or resolution of any effects caused by the delivery of such Unacceptable Waste.

Indemnización. Cliente acuerda indemnizar, mantener inmune, y defender Republic Services, Inc., sus subsidiarios, compañías, divisiones, empleados, oficiales y directores contra de cualquiera y de todas responsabilidades, demandas, penas, pérdidas, juicios, pleitos y los costos incidente además, incluyendo costos de defensa, de acuerdo judicial, y de honorarios razonables del abogado, que pueden ser incurridos en, o como resultado de, la muerte o herida personal a cualquier persona, o daños a cualquier característica, propiedad, contaminación de la tierra o efectos ilícitos en esta Facilidad, causado entero o en parte por el cliente, sus empleados, o sus subcontratistas en botar basura en esta Facilidad. En el caso que el Cliente entrega, bota, basura (según lo determinado por Republic) en este Establecimiento basura inaceptable en los reglamentos de este Establecimiento, el Cliente se compromete asumir todos los costos y obligaciones con el retiro y/o la resolución de cualquier dano(s) causado por la entrega de tal basura inaceptable.



NON-HAZARDOUS WASTE MANIFEST

MANIFEST # 11723

GENERATOR INFORMATION

Generator Name: Tronox LLC
Address: P.O. Box 55
City: Henderson County: Clark
State: NV Zip: 89009
Site Location (if different): 560 W. Lake Mead
Henderson, NV 89015 (702) 592-7727

CUSTOMER/BILLING INFORMATION

Billing Name: NGE LLC c/o Northgate Environment Management
Address: 300 Frank Ogawa Plaza, Ste 510
City: Oakland County: Alameda
State: CA Zip: 94612

Table with 5 columns: Republic Services Approval #, Description of Waste, Volume/Weight, Expiration Date, Container Type. Row 1: 38251011244, Soil for disposal, 36 37/100, 12-31-2011, Tractor with Dump Trailer(s).

*Attach Additional Sheet if necessary

I hereby certify that the above-described materials are non-hazardous wastes as defined by 40 CFR 261 or any applicable state law. Further, that the above named materials are properly classified, described, packaged, marked and labeled, and are in proper condition for transportation according to the applicable regulations of the Department of Transportation.

Susan Crowley
Generator/Authorized Agent Name Signature Date Shipped

TRANSPORTER INFORMATION

Transporter Name: Las Vegas Paving DOT # 191949
Address: 4420 S. Decatur Truck Number: 242
Las Vegas, NV 89103 Phone Number: (702) 353-4355

I certify no hazardous waste or other regulated substance was knowingly introduced to the waste while in my custody. The waste transported in this vehicle is the waste identified above, to the best of my knowledge.

STEVE HAYES
Name of Authorized Agent Signature Date Delivered 10-3-10

DISPOSAL SITE INFORMATION

Site Name: Apex Regional Landfill Phone No. (702) 599-5920
Address: 13550 U.S. Hwy 93 Las Vegas, NV

I hereby acknowledge receipt of the above described materials
Name (Print or Type) Signature Date Received 04 Oct 10

81 Environmental Tech
13550 N Highway 93
Las Vegas, NV 89165

Ticket Type: INBOUND INVOICE

Ticket Number: 1622
Date: 10/04/2010
Time In: 12:50 am
Time Out: 1:10 am

Customer: 001011 - NGE, LLC c/o Northgate Environ Mgmt

Vehicle/Container: 76810P
Contract: Northgate Env. On Site Soils 3825 11
Comment: 3825 10 11244

Gross Weight: 127,920 LB Manual In
Tare Weight: 54,140 LB Scale Out
Net Weight: 73780 LB
Net Tons: 36.89

BOL: 11725

Origin	Yards	Material	Billing	Quantity
Not Applicable	0.00 YD	SW CONTAMINATED SOIL	36.89	TN

Driver:

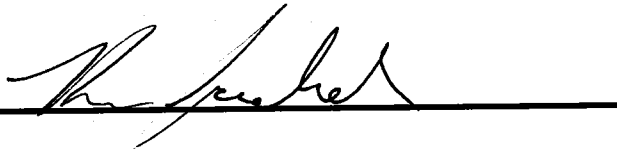

Weighmaster:

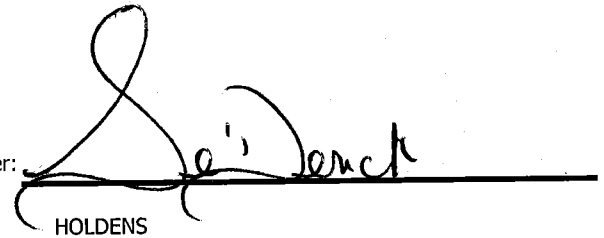

HOLDENS

Indemnification. Customer agrees, by signature above, to indemnify, hold harmless, and defend Republic Services, Inc., its subsidiaries, affiliates, employees, officers and directors from and against any and all liabilities, claims, penalties, forfeitures, suits and the costs and expenses incident thereto, including costs of defense, settlement, and reasonable attorney's fees, which may be incurred, as a result of death or injuries to any person, or damage to any property, contamination of or adverse effects on the environment, caused in whole or in part by the Customer, its employees, or subcontractors in disposing waste at this Facility. In the event Customer delivers Unacceptable Waste (as determined by Republic) Customer agrees to assume all expenses and obligations with the removal and/or resolution of any effects caused by the delivery of such Unacceptable Waste.

Indemnización. Cliente acuerda indemnizar, mantener inmune, y defender Republic Services, Inc., sus subsidiarios, compañías, divisiones, empleados, oficiales y directores contra de cualquiera y de todas responsabilidades, demandas, penas, pérdidas, juicios, pleitos y los costos incidente además, incluyendo costos de defensa, de acuerdo judicial, y de honorarios razonables del abogado, que pueden ser incurridos en, o como resultado de, la muerte o herida personal a cualquier persona, o daños a cualquier característica, propiedad, contaminación de la tierra o efectos ilícitos en esta Facilidad, causado entero o en parte por el cliente, sus empleados, o sus subcontratistas en botar basura en esta Facilidad. En el caso que el Cliente entrega, bota, basura (según lo determinado por Republic) en este Establecimiento basura inaceptable en los reglamentos de este Establecimiento, el Cliente se compromete asumir todos los costos y obligaciones con el retiro y/o la resolución de cualquier dano(s) causado por la entrega de tal basura inaceptable.



NON-HAZARDOUS WASTE MANIFEST

MANIFEST # 11725

GENERATOR INFORMATION

Generator Name: Tronox LLC
Address: P.O. Box 55
City: Henderson County: Clark
State: NV Zip: 89009
Site Location (if different): 560 W. Lake Mead
Henderson, NV 89015 (702) 592-7727

CUSTOMER/BILLING INFORMATION

Billing Name: NGE LLC c/o Northgate Environment Management
Address: 300 Frank Ogawa Plaza, Ste 510
City: Oakland County: Alameda
State: CA Zip: 94612

Table with 5 columns: Republic Services Approval #, Description of Waste, Volume/Weight, Expiration Date, Container Type. Row 1: 38251011244, Soil for disposal, 36 89/75, 12-31-2011, Tractor with Dump Trailer(s).

*Attach Additional Sheet if necessary

I hereby certify that the above-described materials are non-hazardous wastes as defined by 40 CFR 261 or any applicable state law. Further, that the above named materials are properly classified, described, packaged, marked and labeled, and are in proper condition for transportation according to the applicable regulations of the Department of Transportation.

Susan Crowley (Signature)
Generator/Authorized Agent Name Signature Date Shipped

TRANSPORTER INFORMATION

Transporter Name: Las Vegas Paving DOT # 191949
Address: 4420 S. Decatur Truck Number: 241
Las Vegas, NV 89103 Phone Number: (702) 353-4355

I certify no hazardous waste or other regulated substance was knowingly introduced to the waste while in my custody. The waste transported in this vehicle is the waste identified above, to the best of my knowledge.

Ken Jackman (Signature)
Name of Authorized Agent Signature Date Delivered 10-3-2010

DISPOSAL SITE INFORMATION

Site Name: Apex Regional Landfill Phone No: (702) 599-5920
Address: 13550 U.S. Hwy 93 Las Vegas, NV

I hereby acknowledge receipt of the above described materials
Holden, Se Jerich (Signature)
Name (Print or Type) Signature Date Received 04 Oct 10

81 Environmental Tech
13550 N Highway 93
Las Vegas, NV 89165

Ticket Type: INBOUND INVOICE

Ticket Number: 1623
Date: 10/04/2010
Time In: 12:56 am
Time Out: 1:21 am

Customer: 001011 - NGE, LLC c/o Northgate Environ Mgmt

Vehicle/Container: 68263P
Contract: Northgate Env. On Site Soils 3825 11
Comment: 3825 10 11244

Gross Weight: 126,380 LB Manual In
Tare Weight: 53,260 LB Scale Out
Net Weight: 73120 LB
Net Tons: 36.56

BOL: 11726

Origin	Yards	Material	Billing Quantity
Not Applicable	0.00 YD	SW CONTAMINATED SOIL	36.56 TN

Driver:

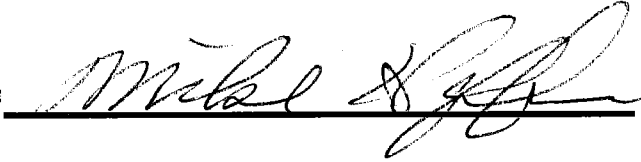

Weighmaster:

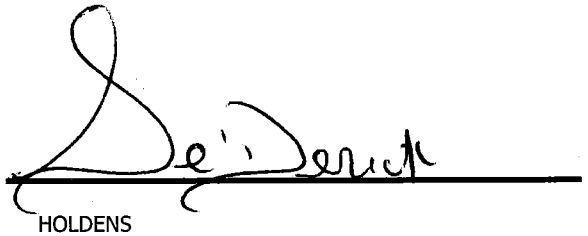

HOLDENS

Indemnification. Customer agrees, by signature above, to indemnify, hold harmless, and defend Republic Services, Inc., its subsidiaries, affiliates, employees, officers and directors from and against any and all liabilities, claims, penalties, forfeitures, suits and the costs and expenses incident thereto, including costs of defense, settlement, and reasonable attorney's fees, which may be incurred, as a result of death or injuries to any person, or damage to any property, contamination of or adverse effects on the environment, caused in whole or in part by the Customer, its employees, or subcontractors in disposing waste at this Facility. In the event Customer delivers Unacceptable Waste (as determined by Republic) Customer agrees to assume all expenses and obligations with the removal and/or resolution of any effects caused by the delivery of such Unacceptable Waste.

Indemnización. Cliente acuerda indemnizar, mantener inmune, y defender Republic Services, Inc., sus subsidiarios, compañías, divisiones, empleados, oficiales y directores contra de cualquiera y de todas responsabilidades, demandas, penas, pérdidas, juicios, pleitos y los costos incidente además, incluyendo costos de defensa, de acuerdo judicial, y de honorarios razonables del abogado, que pueden ser incurridos en, o como resultado de, la muerte o herida personal a cualquier persona, o daños a cualquier característica, propiedad, contaminación de la tierra o efectos ilícitos en esta Facilidad, causado entero o en parte por el cliente, sus empleados, o sus subcontratistas en botar basura en esta Facilidad. En el caso que el Cliente entrega, bota, basura (según lo determinado por Republic) en este Establecimiento basura inaceptable en los reglamentos de este Establecimiento, el Cliente se compromete asumir todos los costos y obligaciones con el retiro y/o la resolución de cualquier dano(s) causado por la entrega de tal basura inaceptable.



NON-HAZARDOUS WASTE MANIFEST

MANIFEST # 11725

GENERATOR INFORMATION

Generator Name: Tronox LLC

Address: P.O. Box 55

City: Henderson County: Clark

State: NV Zip: 89009

Site Location (if different): 560 W. Lake Mead

Henderson, NV 89015 (702) 592-7727

CUSTOMER/BILLING INFORMATION

Billing Name: NGE LLC c/o Northgate Environment Management

Address: 300 Frank Ogawa Plaza, Ste 510

City: Oakland County: Alameda

State: CA Zip: 94612

Table with 5 columns: Republic Services Approval #, Description of Waste, Volume/Weight, Expiration Date, Container Type. Row 1: 38251011244, Soil for disposal, 36.56 Ton, 12-31-2011, Tractor with Dump Trailer(s). Row 2: RZ- #

*Attach Additional Sheet if necessary

I hereby certify that the above-described materials are non-hazardous wastes as defined by 40 CFR 261 or any applicable state law. Further, that the above named materials are properly classified, described, packaged, marked and labeled, and are in proper condition for transportation according to the applicable regulations of the Department of Transportation.

Susan Crowley (Signature) Generator/Authorized Agent Name Date Shipped

TRANSPORTER INFORMATION

Transporter Name: Las Vegas Paving

DOT # 191949

Address: 4420 S. Decatur

Truck Number: 2711

Las Vegas, NV 89103

Phone Number: (702) 353-4355

I certify no hazardous waste or other regulated substance was knowingly introduced to the waste while in my custody. The waste transported in this vehicle is the waste identified above, to the best of my knowledge.

Mike Hefferon (Signature) Name of Authorized Agent Date Delivered 10-5-10

DISPOSAL SITE INFORMATION

Site Name: Apex Regional Landfill

Phone No. (702) 599-5920

Address: 13550 U.S. Hwy 93 Las Vegas, NV

I hereby acknowledge receipt of the above described materials

Holden, Derrick (Signature) Name (Print or Type) Date Received 04/06/10

81 Environmental Tech
13550 N Highway 93
Las Vegas, NV 89165

Ticket Type: INBOUND INVOICE

Ticket Number: 1624
Date: 10/04/2010
Time In: 1:05 am
Time Out: 1:31 am

Customer: 001011 - NGE, LLC c/o Northgate Environ Mgmt

Vehicle/Container: 44161A
Contract: Northgate Env. On Site Soils 3825 11
Comment: 3825 10 11244

Gross Weight: 133,640 LB Manual In
Tare Weight: 52,840 LB Scale Out
Net Weight: 80800 LB
Net Tons: 40.40

BOL: 11724

Origin	Yards	Material	Billing	Quantity
Not Applicable	0.00 YD	SW CONTAMINATED SOIL	40.40	TN

Driver:

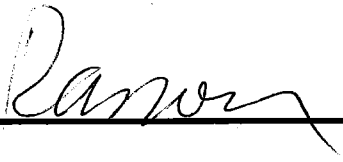

Weighmaster:

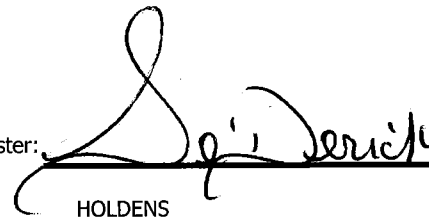

HOLDENS

Indemnification. Customer agrees, by signature above, to indemnify, hold harmless, and defend Republic Services, Inc., its subsidiaries, affiliates, employees, officers and directors from and against any and all liabilities, claims, penalties, forfeitures, suits and the costs and expenses incident thereto, including costs of defense, settlement, and reasonable attorney's fees, which may be incurred, as a result of death or injuries to any person, or damage to any property, contamination of or adverse effects on the environment, caused in whole or in part by the Customer, its employees, or subcontractors in disposing waste at this Facility. In the event Customer delivers Unacceptable Waste (as determined by Republic) Customer agrees to assume all expenses and obligations with the removal and/or resolution of any effects caused by the delivery of such Unacceptable Waste.

Indemnización. Cliente acuerda indemnizar, mantener inmune, y defender Republic Services, Inc., sus subsidiarios, compañías, divisiones, empleados, oficiales y directores contra de cualquiera y de todas responsabilidades, demandas, penas, pérdidas, juicios, pleitos y los costos incidente además, incluyendo costos de defensa, de acuerdo judicial, y de honorarios razonables del abogado, que pueden ser incurridos en, o como resultado de, la muerte o herida personal a cualquier persona, o daños a cualquier característica, propiedad, contaminación de la tierra o efectos ilícitos en esta Facilidad, causado entero o en parte por el cliente, sus empleados, o sus subcontratistas en botar basura en esta Facilidad. En el caso que el Cliente entrega, bota, basura (según lo determinado por Republic) en este Establecimiento basura inaceptable en los reglamentos de este Establecimiento, el Cliente se compromete asumir todos los costos y obligaciones con el retiro y/o la resolución de cualquier dano(s) causado por la entrega de tal basura inaceptable.



NON-HAZARDOUS WASTE MANIFEST

MANIFEST # 11724

GENERATOR INFORMATION

Generator Name: Tronox LLCAddress: P.O. Box 55City: Henderson County: ClarkState: NV Zip: 89009Site Location (if different): 560 W. Lake MeadHenderson, NV 89015 (702) 592-7727

CUSTOMER/BILLING INFORMATION

Billing Name: NGE LLC c/o Northgate Environment ManagementAddress: 300 Frank Ogawa Plaza, Ste 510City: Oakland County: AlamedaState: CA Zip: 94612

Republic Services Approval #	Description of Waste	Volume/Weight	Expiration Date	Container Type
38251011244	Soil for disposal	<u>40 ⁴⁰/_{ton}</u>	12-31-2011	Tractor with Dump Trailer(s)
	RZ- _____ # _____			

*Attach Additional Sheet if necessary

I hereby certify that the above-described materials are non-hazardous wastes as defined by 40 CFR 261 or any applicable state law. Further, that the above named materials are properly classified, described, packaged, marked and labeled, and are in proper condition for transportation according to the applicable regulations of the Department of Transportation.

Susan Crowley Tom Crowley
 Generator/Authorized Agent Name Signature Date Shipped

TRANSPORTER INFORMATION

Transporter Name: Las Vegas PavingDOT # 191949Address: 4420 S. DecaturTruck Number: 1K005Las Vegas, NV 89103Phone Number: (702) 353-4355

I certify no hazardous waste or other regulated substance was knowingly introduced to the waste while in my custody. The waste transported in this vehicle is the waste identified above, to the best of my knowledge.

Ramon Ramon 10-3-10
 Name of Authorized Agent Signature Date Delivered

DISPOSAL SITE INFORMATION

Site Name: Apex Regional LandfillPhone No. (702) 599-5920Address: 13550 U.S. Hwy 93 Las Vegas, NV

I hereby acknowledge receipt of the above described materials

Holden, So'Derrick So'Derrick Holden 04 Oct 10
 Name (Print or Type) Signature Date Received

81 Environmental Tech
13550 N Highway 93
Las Vegas, NV 89165

Ticket Type: INBOUND INVOICE

Ticket Number: 1625
Date: 10/04/2010
Time In: 1:07 am
Time Out: 1:32 am

Customer: 001011 - NGE, LLC c/o Northgate Environ Mgmt

Vehicle/Container: 86113P
Contract: Northgate Env. On Site Soils 3825 11
Comment: 3825 10 11244

Gross Weight: 122,420 LB Manual In
Tare Weight: 55,420 LB Manual Out
Net Weight: 67000 LB
Net Tons: 33.50

BOL: 11727

Origin	Yards	Material	Billing	Quantity
Not Applicable	0.00 YD	SW CONTAMINATED SOIL	33.50	TN

Driver:

J. A. H.

Weighmaster:

[Signature]
HOLDENS

Indemnification. Customer agrees, by signature above, to indemnify, hold harmless, and defend Republic Services, Inc., its subsidiaries, affiliates, employees, officers and directors from and against any and all liabilities, claims, penalties, forfeitures, suits and the costs and expenses incident thereto, including costs of defense, settlement, and reasonable attorney's fees, which may be incurred, as a result of death or injuries to any person, or damage to any property, contamination of or adverse effects on the environment, caused in whole or in part by the Customer, its employees, or subcontractors in disposing waste at this Facility. In the event Customer delivers Unacceptable Waste (as determined by Republic) Customer agrees to assume all expenses and obligations with the removal and/or resolution of any effects caused by the delivery of such Unacceptable Waste.

Indemnización. Cliente acuerda indemnizar, mantener inmune, y defender Republic Services, Inc., sus subsidiarios, compañías, divisiones, empleados, oficiales y directores contra de cualquiera y de todas responsabilidades, demandas, penas, pérdidas, juicios, pleitos y los costos incidente además, incluyendo costos de defensa, de acuerdo judicial, y de honorarios razonables del abogado, que pueden ser incurridos en, o como resultado de, la muerte o herida personal a cualquier persona, o daños a cualquier característica, propiedad, contaminación de la tierra o efectos ilícitos en esta Facilidad, causado entero o en parte por el cliente, sus empleados, o sus subcontratistas en botar basura en esta Facilidad. En el caso que el Cliente entrega, bota, basura (según lo determinado por Republic) en este Establecimiento basura inaceptable en los reglamentos de este Establecimiento, el Cliente se compromete asumir todos los costos y obligaciones con el retiro y/o la resolución de cualquier dano(s) causado por la entrega de tal basura inaceptable.



NON-HAZARDOUS WASTE MANIFEST

MANIFEST # 11727

GENERATOR INFORMATION

Generator Name: Tronox LLC
Address: P.O. Box 55
City: Henderson County: Clark
State: NV Zip: 89009
Site Location (if different): 560 W. Lake Mead
Henderson, NV 89015 (702) 592-7727

CUSTOMER/BILLING INFORMATION

Billing Name: NGE LLC c/o Northgate Environment Management
Address: 300 Frank Ogawa Plaza, Ste 510
City: Oakland County: Alameda
State: CA Zip: 94612

Table with 5 columns: Republic Services Approval #, Description of Waste, Volume/Weight, Expiration Date, Container Type. Row 1: 38251011244, Soil for disposal, 33 20/ton, 12-31-2011, Tractor with Dump Trailer(s). Row 2: RZ- #

*Attach Additional Sheet if necessary

I hereby certify that the above-described materials are non-hazardous wastes as defined by 40 CFR 261 or any applicable state law. Further, that the above named materials are properly classified, described, packaged, marked and labeled, and are in proper condition for transportation according to the applicable regulations of the Department of Transportation.

Susan Crowley
Generator/Authorized Agent Name Signature Date Shipped

TRANSPORTER INFORMATION

Transporter Name: Las Vegas Paving DOT # 191949
Address: 4420 S. Decatur Truck Number: K0019/7
Las Vegas, NV 89103 Phone Number: (702) 353-4355

I certify no hazardous waste or other regulated substance was knowingly introduced to the waste while in my custody. The waste transported in this vehicle is the waste identified above, to the best of my knowledge.

ALBERTO HERRERA
Name of Authorized Agent Signature Date Delivered OCT 3, 2010

DISPOSAL SITE INFORMATION

Site Name: Apex Regional Landfill Phone No. (702) 599-5920
Address: 13550 U.S. Hwy 93 Las Vegas, NV

I hereby acknowledge receipt of the above described materials
Name (Print or Type) Signature Date Received 10/04/10

81 Environmental Tech
13550 N Highway 93
Las Vegas, NV 89165

Ticket Type: INBOUND INVOICE

Ticket Number: 1626
Date: 10/04/2010
Time In: 1:10 am
Time Out: 1:35 am

Customer: 001011 - NGE, LLC c/o Northgate Environ Mgmt

Vehicle/Container: 43078A
Contract: Northgate Env. On Site Soils 3825 11
Comment: 3825 10 11244

Gross Weight: 125,120 LB Manual In
Tare Weight: 53,840 LB Scale Out
Net Weight: 71280 LB
Net Tons: 35.64

BOL: 11728

Origin	Yards	Material	Billing	Quantity
Not Applicable	0.00 YD	SW CONTAMINATED SOIL	35.64	TN

Driver:

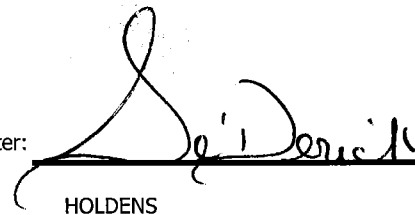

Weighmaster:

HOLDENS

Indemnification. Customer agrees, by signature above, to indemnify, hold harmless, and defend Republic Services, Inc., its subsidiaries, affiliates, employees, officers and directors from and against any and all liabilities, claims, penalties, forfeitures, suits and the costs and expenses incident thereto, including costs of defense, settlement, and reasonable attorney's fees, which may be incurred, as a result of death or injuries to any person, or damage to any property, contamination of or adverse effects on the environment, caused in whole or in part by the Customer, its employees, or subcontractors in disposing waste at this Facility. In the event Customer delivers Unacceptable Waste (as determined by Republic) Customer agrees to assume all expenses and obligations with the removal and/or resolution of any effects caused by the delivery of such Unacceptable Waste.

Indemnización. Cliente acuerda indemnizar, mantener inmune, y defender Republic Services, Inc., sus subsidiarios, compañías, divisiones, empleados, oficiales y directores contra de cualquiera y de todas responsabilidades, demandas, penas, pérdidas, juicios, pleitos y los costos incidente además, incluyendo costos de defensa, de acuerdo judicial, y de honorarios razonables del abogado, que pueden ser incurridos en, o como resultado de, la muerte o herida personal a cualquier persona, o daños a cualquier característica, propiedad, contaminación de la tierra o efectos ilícitos en esta Facilidad, causado entero o en parte por el cliente, sus empleados, o sus subcontratistas en botar basura en esta Facilidad. En el caso que el Cliente entrega, bota, basura (según lo determinado por Republic) en este Establecimiento basura inaceptable en los reglamentos de este Establecimiento, el Cliente se compromete asumir todos los costos y obligaciones con el retiro y/o la resolución de cualquier dano(s) causado por la entrega de tal basura inaceptable.



NON-HAZARDOUS WASTE MANIFEST

MANIFEST # 11728

GENERATOR INFORMATION

Generator Name: Tronox LLC
Address: P.O. Box 55
City: Henderson County: Clark
State: NV Zip: 89009
Site Location (if different): 560 W. Lake Mead
Henderson, NV 89015 (702) 592-7727

CUSTOMER/BILLING INFORMATION

Billing Name: NGE LLC c/o Northgate Environment Management
Address: 300 Frank Ogawa Plaza, Ste 510
City: Oakland County: Alameda
State: CA Zip: 94612

Table with 5 columns: Republic Services Approval #, Description of Waste, Volume/Weight, Expiration Date, Container Type. Row 1: 38251011244, Soil for disposal, 35 64 ton, 12-31-2011, Tractor with Dump Trailer(s).

*Attach Additional Sheet if necessary

I hereby certify that the above-described materials are non-hazardous wastes as defined by 40 CFR 261 or any applicable state law. Further, that the above named materials are properly classified, described, packaged, marked and labeled, and are in proper condition for transportation according to the applicable regulations of the Department of Transportation.

Susan Crowley (Signature)
Generator/Authorized Agent Name Signature Date Shipped

TRANSPORTER INFORMATION

Transporter Name: Las Vegas Paving DOT # 191949
Address: 4420 S. Decatur Truck Number: DWF 200
Las Vegas, NV 89103 Phone Number: (702) 353-4355

I certify no hazardous waste or other regulated substance was knowingly introduced to the waste while in my custody. The waste transported in this vehicle is the waste identified above, to the best of my knowledge.

Dean Freimer (Signature)
Name of Authorized Agent Signature Date Delivered 10-4-10

DISPOSAL SITE INFORMATION

Site Name: Apex Regional Landfill Phone No. (702) 599-5920
Address: 13550 U.S. Hwy 93 Las Vegas, NV

I hereby acknowledge receipt of the above described materials
Holden, S. Derrick (Signature)
Name (Print or Type) Signature Date Received 04 Oct 10

81 Environmental Tech
13550 N Highway 93
Las Vegas, NV 89165

Ticket Type: INBOUND INVOICE

Ticket Number: 1627
Date: 10/04/2010
Time In: 1:13 am
Time Out: 1:36 am

Customer: 001011 - NGE, LLC c/o Northgate Environ Mgmt

Vehicle/Container: 82290P
Contract: Northgate Env. On Site Soils 3825 11
Comment: 3825 10 11244

Gross Weight: 128,440 LB Manual In
Tare Weight: 53,660 LB Manual Out
Net Weight: 74780 LB
Net Tons: 37.39

BOL: 11730

Origin	Yards	Material	Billing	Quantity
Not Applicable	0.00 YD	SW CONTAMINATED SOIL	37.39	TN

Driver:

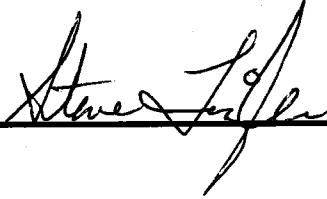

Weighmaster:

HOLDENS

Indemnification. Customer agrees, by signature above, to indemnify, hold harmless, and defend Republic Services, Inc., its subsidiaries, affiliates, employees, officers and directors from and against any and all liabilities, claims, penalties, forfeitures, suits and the costs and expenses incident thereto, including costs of defense, settlement, and reasonable attorney's fees, which may be incurred, as a result of death or injuries to any person, or damage to any property, contamination of or adverse effects on the environment, caused in whole or in part by the Customer, its employees, or subcontractors in disposing waste at this Facility. In the event Customer delivers Unacceptable Waste (as determined by Republic) Customer agrees to assume all expenses and obligations with the removal and/or resolution of any effects caused by the delivery of such Unacceptable Waste.

Indemnización. Cliente acuerda indemnizar, mantener inmune, y defender Republic Services, Inc., sus subsidiarios, compañías, divisiones, empleados, oficiales y directores contra de cualquiera y de todas responsabilidades, demandas, penas, pérdidas, juicios, pleitos y los costos incidente además, incluyendo costos de defensa, de acuerdo judicial, y de honorarios razonables del abogado, que pueden ser incurridos en, o como resultado de, la muerte o herida personal a cualquier persona, o daños a cualquier característica, propiedad, contaminación de la tierra o efectos ilícitos en esta Facilidad, causado entero o en parte por el cliente, sus empleados, o sus subcontratistas en botar basura en esta Facilidad. En el caso que el Cliente entrega, bota, basura (según lo determinado por Republic) en este Establecimiento basura inaceptable en los reglamentos de este Establecimiento, el Cliente se compromete asumir todos los costos y obligaciones con el retiro y/o la resolución de cualquier dano(s) causado por la entrega de tal basura inaceptable.



NON-HAZARDOUS WASTE MANIFEST

MANIFEST # 11730

GENERATOR INFORMATION

Generator Name: Tronox LLC
Address: P.O. Box 55
City: Henderson County: Clark
State: NV Zip: 89009
Site Location (if different): 560 W. Lake Mead
Henderson, NV 89015 (702) 592-7727

CUSTOMER/BILLING INFORMATION

Billing Name: NGE LLC c/o Northgate Environment Management
Address: 300 Frank Ogawa Plaza, Ste 510
City: Oakland County: Alameda
State: CA Zip: 94612

Table with 5 columns: Republic Services Approval #, Description of Waste, Volume/Weight, Expiration Date, Container Type. Row 1: 38251011244, Soil for disposal, 37 39/100, 12-31-2011, Tractor with Dump Trailer(s).

*Attach Additional Sheet if necessary

I hereby certify that the above-described materials are non-hazardous wastes as defined by 40 CFR 261 or any applicable state law. Further, that the above named materials are properly classified, described, packaged, marked and labeled, and are in proper condition for transportation according to the applicable regulations of the Department of Transportation.

Susan Crowley
Generator/Authorized Agent Name Signature Date Shipped

TRANSPORTER INFORMATION

Transporter Name: Las Vegas Paving DOT # 191949
Address: 4420 S. Decatur Truck Number: 06
Las Vegas, NV 89103 Phone Number: (702) 353-4355

I certify no hazardous waste or other regulated substance was knowingly introduced to the waste while in my custody. The waste transported in this vehicle is the waste identified above, to the best of my knowledge.

TRIGLEY STEVE
Name of Authorized Agent Signature Date Delivered 10-3-10

DISPOSAL SITE INFORMATION

Site Name: Apex Regional Landfill Phone No. (702) 599-5920
Address: 13550 U.S. Hwy 93 Las Vegas, NV

I hereby acknowledge receipt of the above described materials
Holden Se'Jerc'h
Name (Print or Type) Signature Date Received 04 Oct 10

81 Environmental Tech
13550 N Highway 93
Las Vegas, NV 89165

Ticket Type: INBOUND INVOICE

Ticket Number: 1628
Date: 10/04/2010
Time In: 1:14 am
Time Out: 1:43 am

Customer: 001011 - NGE, LLC c/o Northgate Environ Mgmt

Vehicle/Container: 44166A
Contract: Northgate Env. On Site Soils 3825 11
Comment: 3825 10 11244

Gross Weight: 139,120 LB Manual In
Tare Weight: 57,200 LB Scale Out
Net Weight: 81920 LB
Net Tons: 40.96

BOL: 11729

Origin	Yards	Material	Billing	Quantity
Not Applicable	0.00 YD	SW CONTAMINATED SOIL	40.96	TN

Driver: _____

Weighmaster: _____

HOLDENS

Indemnification. Customer agrees, by signature above, to indemnify, hold harmless, and defend Republic Services, Inc., its subsidiaries, affiliates, employees, officers and directors from and against any and all liabilities, claims, penalties, forfeitures, suits and the costs and expenses incident thereto, including costs of defense, settlement, and reasonable attorney's fees, which may be incurred, as a result of death or injuries to any person, or damage to any property, contamination of or adverse effects on the environment, caused in whole or in part by the Customer, its employees, or subcontractors in disposing waste at this Facility. In the event Customer delivers Unacceptable Waste (as determined by Republic) Customer agrees to assume all expenses and obligations with the removal and/or resolution of any effects caused by the delivery of such Unacceptable Waste.

Indemnización. Cliente acuerda indemnizar, mantener inmune, y defender Republic Services, Inc., sus subsidiarios, compañías, divisiones, empleados, oficiales y directores contra de cualquiera y de todas responsabilidades, demandas, penas, pérdidas, juicios, pleitos y los costos incidente además, incluyendo costos de defensa, de acuerdo judicial, y de honorarios razonables del abogado, que pueden ser incurridos en, o como resultado de, la muerte o herida personal a cualquier persona, o daños a cualquier característica, propiedad, contaminación de la tierra o efectos ilícitos en esta Facilidad, causado entero o en parte por el cliente, sus empleados, o sus subcontratistas en botar basura en esta Facilidad. En el caso que el Cliente entrega, bota, basura (según lo determinado por Republic) en este Establecimiento basura inaceptable en los reglamentos de este Establecimiento, el Cliente se compromete asumir todos los costos y obligaciones con el retiro y/o la resolución de cualquier dano(s) causado por la entrega de tal basura inaceptable.



NON-HAZARDOUS WASTE MANIFEST

MANIFEST # 11729

GENERATOR INFORMATION

Generator Name: Tronox LLC

Address: P.O. Box 55

City: Henderson County: Clark

State: NV Zip: 89009

Site Location (if different): 560 W. Lake Mead

Henderson, NV 89015 (702) 592-7727

CUSTOMER/BILLING INFORMATION

Billing Name: NGE LLC c/o Northgate Environment Management

Address: 300 Frank Ogawa Plaza, Ste 510

City: Oakland County: Alameda

State: CA Zip: 94612

Republic Services Approval #	Description of Waste	Volume/Weight	Expiration Date	Container Type
38251011244	Soil for disposal	40 ⁹⁶ / _{ton}	12-31-2011	Tractor with Dump Trailer(s)
	RZ- _____ # _____			

*Attach Additional Sheet if necessary

I hereby certify that the above-described materials are non-hazardous wastes as defined by 40 CFR 261 or any applicable state law. Further, that the above named materials are properly classified, described, packaged, marked and labeled, and are in proper condition for transportation according to the applicable regulations of the Department of Transportation.

Susan Crowley *Susan Crowley* _____
 Generator/Authorized Agent Name Signature Date Shipped

TRANSPORTER INFORMATION

Transporter Name: Las Vegas Paving

DOT # 191949

Address: 4420 S. Decatur

Truck Number: 4002

Las Vegas, NV 89103

Phone Number: (702) 353-4355

I certify no hazardous waste or other regulated substance was knowingly introduced to the waste while in my custody. The waste transported in this vehicle is the waste identified above, to the best of my knowledge.

Hugo Castell *HK* 10-3-10
 Name of Authorized Agent Signature Date Delivered

DISPOSAL SITE INFORMATION

Site Name: Apex Regional Landfill

Phone No. (702) 599-5920

Address: 13550 U.S. Hwy 93 Las Vegas, NV

I hereby acknowledge receipt of the above described materials

Holden, Se'Derrick *Se'Derrick Holden* 04 Oct 10
 Name (Print or Type) Signature Date Received

81 Environmental Tech
13550 N Highway 93
Las Vegas, NV 89165

Ticket Type: INBOUND INVOICE

Ticket Number: 1629
Date: 10/04/2010
Time In: 1:33 am
Time Out: 2:02 am

Customer: 001011 - NGE, LLC c/o Northgate Environ Mgmt

Vehicle/Container: 44564A
Contract: Northgate Env. On Site Soils 3825 11
Comment: 3825 10 11244

Gross Weight: 132,140 LB Manual In
Tare Weight: 49,120 LB Scale Out
Net Weight: 83020 LB
Net Tons: 41.51

BOL: 11731

Origin	Yards	Material	Billing	Quantity
Not Applicable	0.00 YD	SW CONTAMINATED SOIL	41.51	TN

Driver:

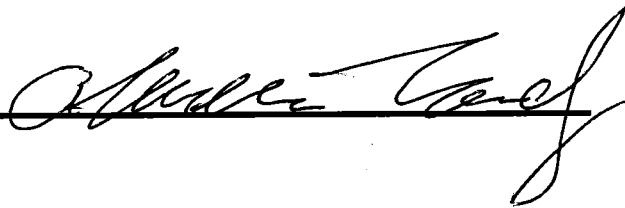

Weighmaster:

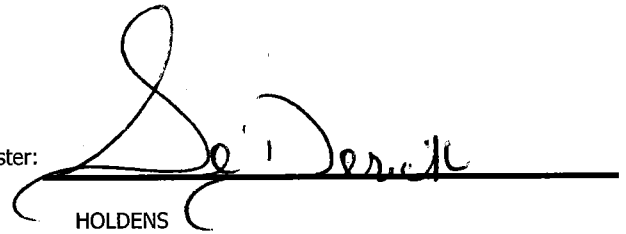

HOLDENS

Indemnification. Customer agrees, by signature above, to indemnify, hold harmless, and defend Republic Services, Inc., its subsidiaries, affiliates, employees, officers and directors from and against any and all liabilities, claims, penalties, forfeitures, suits and the costs and expenses incident thereto, including costs of defense, settlement, and reasonable attorney's fees, which may be incurred, as a result of death or injuries to any person, or damage to any property, contamination of or adverse effects on the environment, caused in whole or in part by the Customer, its employees, or subcontractors in disposing waste at this Facility. In the event Customer delivers Unacceptable Waste (as determined by Republic) Customer agrees to assume all expenses and obligations with the removal and/or resolution of any effects caused by the delivery of such Unacceptable Waste.

Indemnización. Cliente acuerda indemnizar, mantener inmune, y defender Republic Services, Inc., sus subsidiarios, compañías, divisiones, empleados, oficiales y directores contra de cualquiera y de todas responsabilidades, demandas, penas, pérdidas, juicios, pleitos y los costos incidente además, incluyendo costos de defensa, de acuerdo judicial, y de honorarios razonables del abogado, que pueden ser incurridos en, o como resultado de, la muerte o herida personal a cualquier persona, o daños a cualquier característica, propiedad, contaminación de la tierra o efectos ilícitos en esta Facilidad, causado entero o en parte por el cliente, sus empleados, o sus subcontratistas en botar basura en esta Facilidad. En el caso que el Cliente entrega, bota, basura (según lo determinado por Republic) en este Establecimiento basura inaceptable en los reglamentos de este Establecimiento, el Cliente se compromete asumir todos los costos y obligaciones con el retiro y/o la resolución de cualquier dano(s) causado por la entrega de tal basura inaceptable.



NON-HAZARDOUS WASTE MANIFEST

MANIFEST # 11731

GENERATOR INFORMATION

Generator Name: Tronox LLC

Address: P.O. Box 55

City: Henderson County: Clark

State: NV Zip: 89009

Site Location (if different): 560 W. Lake Mead

Henderson, NV 89015 (702) 592-7727

CUSTOMER/BILLING INFORMATION

Billing Name: NGE LLC c/o Northgate Environment Management

Address: 300 Frank Ogawa Plaza, Ste 510

City: Oakland County: Alameda

State: CA Zip: 94612

Republic Services Approval #	Description of Waste	Volume/Weight	Expiration Date	Container Type
38251011244	Soil for disposal	47 ²¹ / ₁₅₇	12-31-2011	Tractor with Dump Trailer(s)
	RZ- _____ # _____			

*Attach Additional Sheet if necessary

I hereby certify that the above-described materials are non-hazardous wastes as defined by 40 CFR 261 or any applicable state law. Further, that the above named materials are properly classified, described, packaged, marked and labeled, and are in proper condition for transportation according to the applicable regulations of the Department of Transportation.

Susan Crowley
Generator/Authorized Agent Name
Signature
Date Shipped

TRANSPORTER INFORMATION

Transporter Name: Las Vegas Paving

DOT # 191949

Address: 4420 S. Decatur

Truck Number: K003

Las Vegas, NV 89103

Phone Number: (702) 353-4355

I certify no hazardous waste or other regulated substance was knowingly introduced to the waste while in my custody. The waste transported in this vehicle is the waste identified above, to the best of my knowledge.

Aseacione
Name of Authorized Agent
Signature
Date Delivered 10/03/10

DISPOSAL SITE INFORMATION

Site Name: Apex Regional Landfill

Phone No. (702) 599-5920

Address: 13550 U.S. Hwy 93 Las Vegas, NV

I hereby acknowledge receipt of the above described materials

Holden, Se Derick
Name (Print or Type)
Signature
Date Received 04 Oct 10

81 Environmental Tech
13550 N Highway 93
Las Vegas, NV 89165

Ticket Type: INBOUND INVOICE

Ticket Number: 1630
Date: 10/04/2010
Time In: 1:59 am
Time Out: 2:26 am

Customer: 001011 - NGE, LLC c/o Northgate Environ Mgmt

Vehicle/Container: 44164A
Contract: Northgate Env. On Site Soils 3825 11
Comment: 3825 10 11244

Gross Weight: 116,940 LB Manual In
Tare Weight: 55,640 LB Scale Out
Net Weight: 61300 LB
Net Tons: 30.65

BOL: 11732

Origin	Yards	Material	Billing	Quantity
Not Applicable	0.00 YD	SW CONTAMINATED SOIL	30.65	TN

Driver:

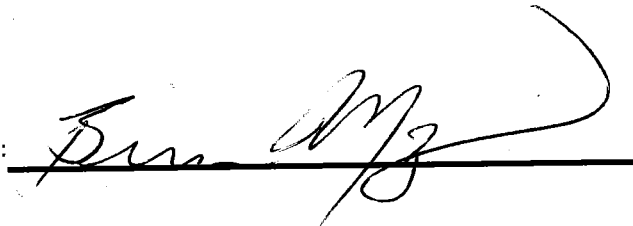

Weighmaster:

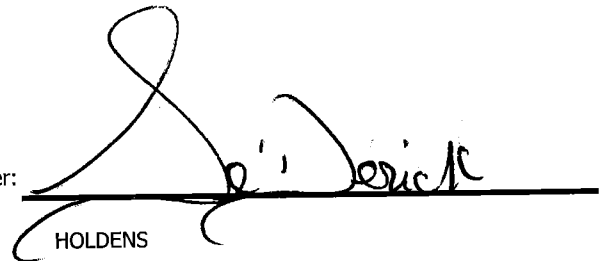

HOLDENS

Indemnification. Customer agrees, by signature above, to indemnify, hold harmless, and defend Republic Services, Inc., its subsidiaries, affiliates, employees, officers and directors from and against any and all liabilities, claims, penalties, forfeitures, suits and the costs and expenses incident thereto, including costs of defense, settlement, and reasonable attorney's fees, which may be incurred, as a result of death or injuries to any person, or damage to any property, contamination of or adverse effects on the environment, caused in whole or in part by the Customer, its employees, or subcontractors in disposing waste at this Facility. In the event Customer delivers Unacceptable Waste (as determined by Republic) Customer agrees to assume all expenses and obligations with the removal and/or resolution of any effects caused by the delivery of such Unacceptable Waste.

Indemnización. Cliente acuerda indemnizar, mantener inmune, y defender Republic Services, Inc., sus subsidiarios, compañías, divisiones, empleados, oficiales y directores contra de cualquiera y de todas responsabilidades, demandas, penas, pérdidas, juicios, pleitos y los costos incidente además, incluyendo costos de defensa, de acuerdo judicial, y de honorarios razonables del abogado, que pueden ser incurridos en, o como resultado de, la muerte o herida personal a cualquier persona, o daños a cualquier característica, propiedad, contaminación de la tierra o efectos ilícitos en esta Facilidad, causado entero o en parte por el cliente, sus empleados, o sus subcontratistas en botar basura en esta Facilidad. En el caso que el Cliente entrega, bota, basura (según lo determinado por Republic) en este Establecimiento basura inaceptable en los reglamentos de este Establecimiento, el Cliente se compromete asumir todos los costos y obligaciones con el retiro y/o la resolución de cualquier dano(s) causado por la entrega de tal basura inaceptable.



NON-HAZARDOUS WASTE MANIFEST

MANIFEST # 11732

GENERATOR INFORMATION

Generator Name: Tronox LLC

Address: P.O. Box 55

City: Henderson County: Clark

State: NV Zip: 89009

Site Location (if different): 560 W. Lake Mead

Henderson, NV 89015 (702) 592-7727

CUSTOMER/BILLING INFORMATION

Billing Name: NGE LLC c/o Northgate Environment Management

Address: 300 Frank Ogawa Plaza, Ste 510

City: Oakland County: Alameda

State: CA Zip: 94612

Republic Services Approval #	Description of Waste	Volume/Weight	Expiration Date	Container Type
38251011244	Soil for disposal	30 ⁶⁵ / _{ton}	12-31-2011	Tractor with Dump Trailer(s)
	RZ- #			

*Attach Additional Sheet if necessary

I hereby certify that the above-described materials are non-hazardous wastes as defined by 40 CFR 261 or any applicable state law. Further, that the above named materials are properly classified, described, packaged, marked and labeled, and are in proper condition for transportation according to the applicable regulations of the Department of Transportation.

Susan Crowley Generator/Authorized Agent Name Signature Date Shipped

TRANSPORTER INFORMATION

Transporter Name: Las Vegas Paving

DOT # 191949

Address: 4420 S. Decatur

Truck Number: K-006

Las Vegas, NV 89103

Phone Number: (702) 353-4355

I certify no hazardous waste or other regulated substance was knowingly introduced to the waste while in my custody. The waste transported in this vehicle is the waste identified above, to the best of my knowledge.

Brian Mulvey Name of Authorized Agent Signature Date Delivered

DISPOSAL SITE INFORMATION

Site Name: Apex Regional Landfill

Phone No. (702) 599-5920

Address: 13550 U.S. Hwy 93 Las Vegas, NV

I hereby acknowledge receipt of the above described materials Holden SeDrick Name (Print or Type) Signature Date Received 01/Oct/10

81 Environmental Tech
13550 N Highway 93
Las Vegas, NV 89165

Ticket Type: INBOUND INVOICE

Ticket Number: 1631
Date: 10/04/2010
Time In: 2:16 am
Time Out: 2:39 am

Customer: 001011 - NGE, LLC c/o Northgate Environ Mgmt

Vehicle/Container: 81495P
Contract: Northgate Env. On Site Soils 3825 11
Comment: 3825 10 11244

Gross Weight: 118,880 LB Manual In
Tare Weight: 50,360 LB Manual Out
Net Weight: 68520 LB
Net Tons: 34.26

BOL: 11733

Origin	Yards	Material	Billing Quantity
Not Applicable	0.00 YD	SW CONTAMINATED SOIL	34.26 TN

Driver: _____

Weighmaster: _____

HOLDENS

Indemnification. Customer agrees, by signature above, to indemnify, hold harmless, and defend Republic Services, Inc., its subsidiaries, affiliates, employees, officers and directors from and against any and all liabilities, claims, penalties, forfeitures, suits and the costs and expenses incident thereto, including costs of defense, settlement, and reasonable attorney's fees, which may be incurred, as a result of death or injuries to any person, or damage to any property, contamination of or adverse effects on the environment, caused in whole or in part by the Customer, its employees, or subcontractors in disposing waste at this Facility. In the event Customer delivers Unacceptable Waste (as determined by Republic) Customer agrees to assume all expenses and obligations with the removal and/or resolution of any effects caused by the delivery of such Unacceptable Waste.

Indemnización. Cliente acuerda indemnizar, mantener inmune, y defender Republic Services, Inc., sus subsidiarios, compañías, divisiones, empleados, oficiales y directores contra de cualquiera y de todas responsabilidades, demandas, penas, pérdidas, juicios, pleitos y los costos incidente además, incluyendo costos de defensa, de acuerdo judicial, y de honorarios razonables del abogado, que pueden ser incurridos en, o como resultado de, la muerte o herida personal a cualquier persona, o daños a cualquier característica, propiedad, contaminación de la tierra o efectos ilícitos en esta Facilidad, causado entero o en parte por el cliente, sus empleados, o sus subcontratistas en botar basura en esta Facilidad. En el caso que el Cliente entrega, bota, basura (según lo determinado por Republic) en este Establecimiento basura inaceptable en los reglamentos de este Establecimiento, el Cliente se compromete asumir todos los costos y obligaciones con el retiro y/o la resolución de cualquier dano(s) causado por la entrega de tal basura inaceptable.



NON-HAZARDOUS WASTE MANIFEST

MANIFEST # 11733

GENERATOR INFORMATION

Generator Name: Tronox LLC

Address: P.O. Box 55

City: Henderson County: Clark

State: NV Zip: 89009

Site Location (if different): 560 W. Lake Mead

Henderson, NV 89015 (702) 592-7727

CUSTOMER/BILLING INFORMATION

Billing Name: NGE LLC c/o Northgate Environment Management

Address: 300 Frank Ogawa Plaza, Ste 510

City: Oakland County: Alameda

State: CA Zip: 94612

Republic Services Approval #	Description of Waste	Volume/Weight	Expiration Date	Container Type
38251011244	Soil for disposal	34 ²⁶ / ₁₀₀	12-31-2011	Tractor with Dump Trailer(s)
	RZ- _____ # _____			

*Attach Additional Sheet if necessary

I hereby certify that the above-described materials are non-hazardous wastes as defined by 40 CFR 261 or any applicable state law. Further, that the above named materials are properly classified, described, packaged, marked and labeled, and are in proper condition for transportation according to the applicable regulations of the Department of Transportation.

Susan Crowley

Susan Crowley

Generator/Authorized Agent Name

Signature

Date Shipped

TRANSPORTER INFORMATION

Transporter Name: Las Vegas Paving

DOT # 191949

Address: 4420 S. Decatur

Truck Number: 175

Las Vegas, NV 89103

Phone Number: (702) 353-4355

I certify no hazardous waste or other regulated substance was knowingly introduced to the waste while in my custody. The waste transported in this vehicle is the waste identified above, to the best of my knowledge.

Andrew Walker

Andrew Walker

Name of Authorized Agent

Signature

Date Delivered

10-4-10

DISPOSAL SITE INFORMATION

Site Name: Apex Regional Landfill

Phone No. (702) 599-5920

Address: 13550 U.S. Hwy 93 Las Vegas, NV

I hereby acknowledge receipt of the above described materials

Holden, Sr. Derek

Derek Holden

Name (Print or Type)

Signature

Date Received

04 Oct 10

81 Environmental Tech
13550 N Highway 93
Las Vegas, NV 89165

Ticket Type: INBOUND INVOICE

Ticket Number: 1632
Date: 10/04/2010
Time In: 2:20 am
Time Out: 2:48 am

Customer: 001011 - NGE, LLC c/o Northgate Environ Mgmt

Vehicle/Container: 20915A
Contract: Northgate Env. On Site Soils 3825 11
Comment: 3825 10 11244

Gross Weight: 121,600 LB Manual In
Tare Weight: 52,880 LB Scale Out
Net Weight: 68720 LB
Net Tons: 34.36

BOL: 11734

Origin	Yards	Material	Billing	Quantity
Not Applicable	0.00 YD	SW CONTAMINATED SOIL	34.36	TN

Driver:

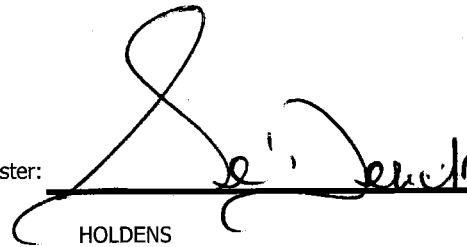

Weighmaster:

HOLDENS

Indemnification. Customer agrees, by signature above, to indemnify, hold harmless, and defend Republic Services, Inc., its subsidiaries, affiliates, employees, officers and directors from and against any and all liabilities, claims, penalties, forfeitures, suits and the costs and expenses incident thereto, including costs of defense, settlement, and reasonable attorney's fees, which may be incurred, as a result of death or injuries to any person, or damage to any property, contamination of or adverse effects on the environment, caused in whole or in part by the Customer, its employees, or subcontractors in disposing waste at this Facility. In the event Customer delivers Unacceptable Waste (as determined by Republic) Customer agrees to assume all expenses and obligations with the removal and/or resolution of any effects caused by the delivery of such Unacceptable Waste.

Indemnización. Cliente acuerda indemnizar, mantener inmune, y defender Republic Services, Inc., sus subsidiarios, compañías, divisiones, empleados, oficiales y directores contra de cualquiera y de todas responsabilidades, demandas, penas, pérdidas, juicios, pleitos y los costos incidente además, incluyendo costos de defensa, de acuerdo judicial, y de honorarios razonables del abogado, que pueden ser incurridos en, o como resultado de, la muerte o herida personal a cualquier persona, o daños a cualquier característica, propiedad, contaminación de la tierra o efectos ilícitos en esta Facilidad, causado entero o en parte por el cliente, sus empleados, o sus subcontratistas en botar basura en esta Facilidad. En el caso que el Cliente entrega, bota, basura (según lo determinado por Republic) en este Establecimiento basura inaceptable en los reglamentos de este Establecimiento, el Cliente se compromete asumir todos los costos y obligaciones con el retiro y/o la resolución de cualquier dano(s) causado por la entrega de tal basura inaceptable.



NON-HAZARDOUS WASTE MANIFEST

MANIFEST # 11734

GENERATOR INFORMATION

Generator Name: Tronox LLC
Address: P.O. Box 55
City: Henderson County: Clark
State: NV Zip: 89009
Site Location (if different): 560 W. Lake Mead
Henderson, NV 89015 (702) 592-7727

CUSTOMER/BILLING INFORMATION

Billing Name: NGE LLC c/o Northgate Environment Management
Address: 300 Frank Ogawa Plaza, Ste 510
City: Oakland County: Alameda
State: CA Zip: 94612

Table with 5 columns: Republic Services Approval #, Description of Waste, Volume/Weight, Expiration Date, Container Type. Row 1: 38251011244, Soil for disposal, 34 36/150, 12-31-2011, Tractor with Dump Trailer(s).

*Attach Additional Sheet if necessary

I hereby certify that the above-described materials are non-hazardous wastes as defined by 40 CFR 261 or any applicable state law. Further, that the above named materials are properly classified, described, packaged, marked and labeled, and are in proper condition for transportation according to the applicable regulations of the Department of Transportation.

Susan Crowley (Signature)
Generator/Authorized Agent Name Signature Date Shipped

TRANSPORTER INFORMATION

Transporter Name: Las Vegas Paving DOT # 191949
Address: 4420 S. Decatur Truck Number: 00
Las Vegas, NV 89103 Phone Number: (702) 353-4355

I certify no hazardous waste or other regulated substance was knowingly introduced to the waste while in my custody. The waste transported in this vehicle is the waste identified above, to the best of my knowledge.

Tom Kowaly (Signature) Thomas R. Lyon (Signature) 10-9-10
Name of Authorized Agent Signature Date Delivered

DISPOSAL SITE INFORMATION

Site Name: Apex Regional Landfill Phone No. (702) 599-5920
Address: 13550 U.S. Hwy 93 Las Vegas, NV

I hereby acknowledge receipt of the above described materials

Allen, Se Dorck (Signature) Le'Derrick Holden (Signature) 04 Oct 10
Name (Print or Type) Signature Date Received

81 Environmental Tech
13550 N Highway 93
Las Vegas, NV 89165

Ticket Type: INBOUND INVOICE

Ticket Number: 1633
Date: 10/04/2010
Time In: 2:22 am
Time Out: 2:48 am

Customer: 001011 - NGE, LLC c/o Northgate Environ Mgmt

Vehicle/Container: 81494P
Contract: Northgate Env. On Site Soils 3825 11
Comment: 3825 10 11244

Gross Weight: 120,620 LB Manual In
Tare Weight: 51,080 LB Manual Out
Net Weight: 69540 LB
Net Tons: 34.77

BOL: 11735

Origin	Yards	Material	Billing Quantity
Not Applicable	0.00 YD	SW CONTAMINATED SOIL	34.77 TN

Driver: _____



Weighmaster: _____

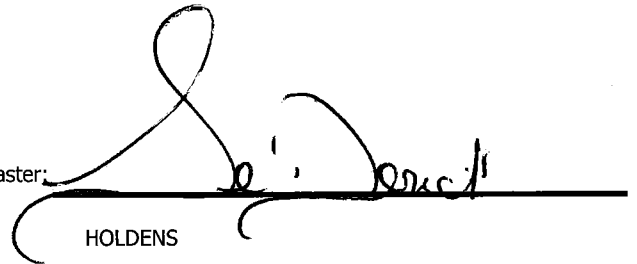

HOLDENS

Indemnification. Customer agrees, by signature above, to indemnify, hold harmless, and defend Republic Services, Inc., its subsidiaries, affiliates, employees, officers and directors from and against any and all liabilities, claims, penalties, forfeitures, suits and the costs and expenses incident thereto, including costs of defense, settlement, and reasonable attorney's fees, which may be incurred, as a result of death or injuries to any person, or damage to any property, contamination of or adverse effects on the environment, caused in whole or in part by the Customer, its employees, or subcontractors in disposing waste at this Facility. In the event Customer delivers Unacceptable Waste (as determined by Republic) Customer agrees to assume all expenses and obligations with the removal and/or resolution of any effects caused by the delivery of such Unacceptable Waste.

Indemnización. Cliente acuerda indemnizar, mantener inmune, y defender Republic Services, Inc., sus subsidiarios, compañías, divisiones, empleados, oficiales y directores contra de cualquiera y de todas responsabilidades, demandas, penas, pérdidas, juicios, pleitos y los costos incidente además, incluyendo costos de defensa, de acuerdo judicial, y de honorarios razonables del abogado, que pueden ser incurridos en, o como resultado de, la muerte o herida personal a cualquier persona, o daños a cualquier característica, propiedad, contaminación de la tierra o efectos ilícitos en esta Facilidad, causado entero o en parte por el cliente, sus empleados, o sus subcontratistas en botar basura en esta Facilidad. En el caso que el Cliente entrega, bota, basura (según lo determinado por Republic) en este Establecimiento basura inaceptable en los reglamentos de este Establecimiento, el Cliente se compromete asumir todos los costos y obligaciones con el retiro y/o la resolución de cualquier dano(s) causado por la entrega de tal basura inaceptable.



NON-HAZARDOUS WASTE MANIFEST

MANIFEST # 11735

GENERATOR INFORMATION

Generator Name: Tronox LLC
Address: P.O. Box 55
City: Henderson County: Clark
State: NV Zip: 89009
Site Location (if different): 560 W. Lake Mead
Henderson, NV 89015 (702) 592-7727

CUSTOMER/BILLING INFORMATION

Billing Name: NGE LLC c/o Northgate Environment Management
Address: 300 Frank Ogawa Plaza, Ste 510
City: Oakland County: Alameda
State: CA Zip: 94612

Table with 5 columns: Republic Services Approval #, Description of Waste, Volume/Weight, Expiration Date, Container Type. Row 1: 38251011244, Soil for disposal, 34 Tons, 12-31-2011, Tractor with Dump Trailer(s).

*Attach Additional Sheet if necessary

I hereby certify that the above-described materials are non-hazardous wastes as defined by 40 CFR 261 or any applicable state law. Further, that the above named materials are properly classified, described, packaged, marked and labeled, and are in proper condition for transportation according to the applicable regulations of the Department of Transportation.

Susan Crowley
Generator/Authorized Agent Name Signature Date Shipped

TRANSPORTER INFORMATION

Transporter Name: Las Vegas Paving DOT # 191949
Address: 4420 S. Decatur Truck Number: 125
Las Vegas, NV 89103 Phone Number: (702) 353-4355

I certify no hazardous waste or other regulated substance was knowingly introduced to the waste while in my custody. The waste transported in this vehicle is the waste identified above, to the best of my knowledge.

Calvin Paguyo Calvin Paguyo 10/03/10
Name of Authorized Agent Signature Date Delivered

DISPOSAL SITE INFORMATION

Site Name: Apex Regional Landfill Phone No. (702) 599-5920
Address: 13550 U.S. Hwy 93 Las Vegas, NV

I hereby acknowledge receipt of the above described materials
Holden, Derrick Se Derrick Holden 09/06/10
Name (Print or Type) Signature Date Received

81 Environmental Tech
13550 N Highway 93
Las Vegas, NV 89165

Ticket Type: INBOUND INVOICE

Ticket Number: 1634
Date: 10/04/2010
Time In: 2:24 am
Time Out: 2:51 am

Customer: 001011 - NGE, LLC c/o Northgate Environ Mgmt

Vehicle/Container: 81496P
Contract: Northgate Env. On Site Soils 3825 11
Comment: 3825 10 11244

Gross Weight: 121,480 LB Manual In
Tare Weight: 50,260 LB Manual Out
Net Weight: 71,220 LB
Net Tons: 35.61

BOL: 11736

Origin	Yards	Material	Billing	Quantity
Not Applicable	0.00 YD	SW CONTAMINATED SOIL	35.61	TN

Driver:

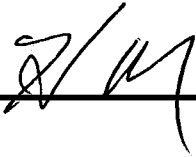

Weighmaster:

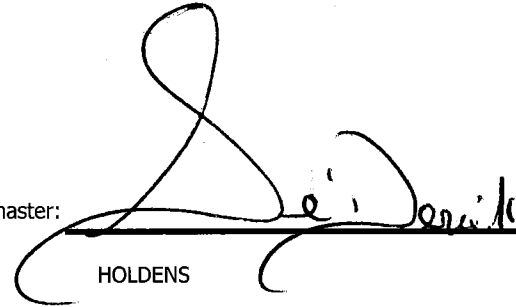

HOLDENS

Indemnification. Customer agrees, by signature above, to indemnify, hold harmless, and defend Republic Services, Inc., its subsidiaries, affiliates, employees, officers and directors from and against any and all liabilities, claims, penalties, forfeitures, suits and the costs and expenses incident thereto, including costs of defense, settlement, and reasonable attorney's fees, which may be incurred, as a result of death or injuries to any person, or damage to any property, contamination of or adverse effects on the environment, caused in whole or in part by the Customer, its employees, or subcontractors in disposing waste at this Facility. In the event Customer delivers Unacceptable Waste (as determined by Republic) Customer agrees to assume all expenses and obligations with the removal and/or resolution of any effects caused by the delivery of such Unacceptable Waste.

Indemnización. Cliente acuerda indemnizar, mantener inmune, y defender Republic Services, Inc., sus subsidiarios, compañías, divisiones, empleados, oficiales y directores contra de cualquiera y de todas responsabilidades, demandas, penas, pérdidas, juicios, pleitos y los costos incidente además, incluyendo costos de defensa, de acuerdo judicial, y de honorarios razonables del abogado, que pueden ser incurridos en, o como resultado de, la muerte o herida personal a cualquier persona, o daños a cualquier característica, propiedad, contaminación de la tierra o efectos ilícitos en esta Facilidad, causado entero o en parte por el cliente, sus empleados, o sus subcontratistas en botar basura en esta Facilidad. En el caso que el Cliente entrega, bota, basura (según lo determinado por Republic) en este Establecimiento basura inaceptable en los reglamentos de este Establecimiento, el Cliente se compromete asumir todos los costos y obligaciones con el retiro y/o la resolución de cualquier dano(s) causado por la entrega de tal basura inaceptable.



NON-HAZARDOUS WASTE MANIFEST

MANIFEST # 11736

GENERATOR INFORMATION

Generator Name: Tronox LLC
Address: P.O. Box 55
City: Henderson County: Clark
State: NV Zip: 89009
Site Location (if different): 560 W. Lake Mead
Henderson, NV 89015 (702) 592-7727

CUSTOMER/BILLING INFORMATION

Billing Name: NGE LLC c/o Northgate Environment Management
Address: 300 Frank Ogawa Plaza, Ste 510
City: Oakland County: Alameda
State: CA Zip: 94612

Table with 5 columns: Republic Services Approval #, Description of Waste, Volume/Weight, Expiration Date, Container Type. Row 1: 38251011244, Soil for disposal, 35 1/2 ton, 12-31-2011, Tractor with Dump Trailer(s). Row 2: RZ- #

*Attach Additional Sheet if necessary

I hereby certify that the above-described materials are non-hazardous wastes as defined by 40 CFR 261 or any applicable state law. Further, that the above named materials are properly classified, described, packaged, marked and labeled, and are in proper condition for transportation according to the applicable regulations of the Department of Transportation.

Susan Crowley
Generator/Authorized Agent Name Signature Date Shipped

TRANSPORTER INFORMATION

Transporter Name: Las Vegas Paving DOT # 191949
Address: 4420 S. Decatur Truck Number: 145
Las Vegas, NV 89103 Phone Number: (702) 353-4355

I certify no hazardous waste or other regulated substance was knowingly introduced to the waste while in my custody. The waste transported in this vehicle is the waste identified above, to the best of my knowledge.

Harry M'Gill Signature 10-3-10
Name of Authorized Agent Signature Date Delivered

DISPOSAL SITE INFORMATION

Site Name: Apex Regional Landfill Phone No: (702) 599-5920
Address: 13550 U.S. Hwy 93 Las Vegas, NV

I hereby acknowledge receipt of the above described materials
Holden, Se'Derrick Signature Date Received 04 Oct 10
Name (Print or Type) Signature Date Received

81 Environmental Tech
13550 N Highway 93
Las Vegas, NV 89165

Ticket Type: INBOUND INVOICE

Ticket Number: 1635
Date: 10/04/2010
Time In: 2:41 am
Time Out: 3:06 am

Customer: 001011 - NGE, LLC c/o Northgate Environ Mgmt

Vehicle/Container: 81460P
Contract: Northgate Env. On Site Soils 3825 11
Comment: 3825.10 11244

Gross Weight: 124,960 LB Manual In
Tare Weight: 52,220 LB Scale Out
Net Weight: 72740 LB
Net Tons: 36.37

BOL: 11739

Origin	Yards	Material	Billing	Quantity
Not Applicable	0.00 YD	SW CONTAMINATED SOIL	36.37	TN

Driver: _____

Weighmaster: _____

HOLDENS

Indemnification. Customer agrees, by signature above, to indemnify, hold harmless, and defend Republic Services, Inc., its subsidiaries, affiliates, employees, officers and directors from and against any and all liabilities, claims, penalties, forfeitures, suits and the costs and expenses incident thereto, including costs of defense, settlement, and reasonable attorney's fees, which may be incurred, as a result of death or injuries to any person, or damage to any property, contamination of or adverse effects on the environment, caused in whole or in part by the Customer, its employees, or subcontractors in disposing waste at this Facility. In the event Customer delivers Unacceptable Waste (as determined by Republic) Customer agrees to assume all expenses and obligations with the removal and/or resolution of any effects caused by the delivery of such Unacceptable Waste.

Indemnización. Cliente acuerda indemnizar, mantener inmune, y defender Republic Services, Inc., sus subsidiarios, compañías, divisiones, empleados, oficiales y directores contra de cualquiera y de todas responsabilidades, demandas, penas, pérdidas, juicios, pleitos y los costos incidente además, incluyendo costos de defensa, de acuerdo judicial, y de honorarios razonables del abogado, que pueden ser incurridos en, o como resultado de, la muerte o herida personal a cualquier persona, o daños a cualquier característica, propiedad, contaminación de la tierra o efectos ilícitos en esta Facilidad, causado entero o en parte por el cliente, sus empleados, o sus subcontratistas en botar basura en esta Facilidad. En el caso que el Cliente entrega, bota, basura (según lo determinado por Republic) en este Establecimiento basura inaceptable en los reglamentos de este Establecimiento, el Cliente se compromete asumir todos los costos y obligaciones con el retiro y/o la resolución de cualquier dano(s) causado por la entrega de tal basura inaceptable.



NON-HAZARDOUS WASTE MANIFEST

MANIFEST # 11739

GENERATOR INFORMATION

Generator Name: Tronox LLC
Address: P.O. Box 55
City: Henderson County: Clark
State: NV Zip: 89009
Site Location (if different): 560 W. Lake Mead
Henderson, NV 89015 (702) 592-7727

CUSTOMER/BILLING INFORMATION

Billing Name: NGE LLC c/o Northgate Environment Management
Address: 300 Frank Ogawa Plaza, Ste 510
City: Oakland County: Alameda
State: CA Zip: 94612

Table with 5 columns: Republic Services Approval #, Description of Waste, Volume/Weight, Expiration Date, Container Type. Row 1: 38251011244, Soil for disposal, 36 37/100, 12-31-2011, Tractor with Dump Trailer(s).

*Attach Additional Sheet if necessary

I hereby certify that the above-described materials are non-hazardous wastes as defined by 40 CFR 261 or any applicable state law. Further, that the above named materials are properly classified, described, packaged, marked and labeled, and are in proper condition for transportation according to the applicable regulations of the Department of Transportation.

Susan Crowley
Generator/Authorized Agent Name Signature Date Shipped

TRANSPORTER INFORMATION

Transporter Name: Las Vegas Paving DOT # 191949
Address: 4420 S. Decatur Truck Number: 27
Las Vegas, NV 89103 Phone Number: (702) 353-4355

I certify no hazardous waste or other regulated substance was knowingly introduced to the waste while in my custody. The waste transported in this vehicle is the waste identified above, to the best of my knowledge.

Daniel Cardenas
Name of Authorized Agent Signature Date Delivered 10-3-2010

DISPOSAL SITE INFORMATION

Site Name: Apex Regional Landfill Phone No. (702) 599-5920
Address: 13550 U.S. Hwy 93 Las Vegas, NV

I hereby acknowledge receipt of the above described materials
Name (Print or Type) Signature Date Received 01/02/10

81 Environmental Tech
13550 N Highway 93
Las Vegas, NV 89165

Ticket Type: INBOUND INVOICE

Ticket Number: 1636
Date: 10/04/2010
Time In: 2:36 am
Time Out: 3:06 am

Customer: 001011 - NGE, LLC c/o Northgate Environ Mgmt

Vehicle/Container: 192460
Contract: Northgate Env. On Site Soils 3825 11
Comment: 3825 10 11244

Gross Weight: 124,420 LB Manual In
Tare Weight: 52,860 LB Manual Out
Net Weight: 71560 LB
Net Tons: 35.78

BOL: 11738

Origin	Yards	Material	Billing Quantity
Not Applicable	0.00 YD	SW CONTAMINATED SOIL	35.78 TN

Driver:

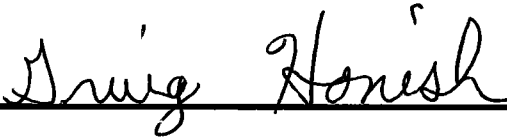

Weighmaster:

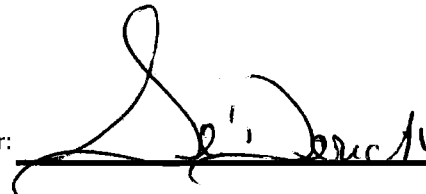

HOLDENS

Indemnification. Customer agrees, by signature above, to indemnify, hold harmless, and defend Republic Services, Inc., its subsidiaries, affiliates, employees, officers and directors from and against any and all liabilities, claims, penalties, forfeitures, suits and the costs and expenses incident thereto, including costs of defense, settlement, and reasonable attorney's fees, which may be incurred, as a result of death or injuries to any person, or damage to any property, contamination of or adverse effects on the environment, caused in whole or in part by the Customer, its employees, or subcontractors in disposing waste at this Facility. In the event Customer delivers Unacceptable Waste (as determined by Republic) Customer agrees to assume all expenses and obligations with the removal and/or resolution of any effects caused by the delivery of such Unacceptable Waste.

Indemnización. Cliente acuerda indemnizar, mantener inmune, y defender Republic Services, Inc., sus subsidiarios, compañías, divisiones, empleados, oficiales y directores contra de cualquiera y de todas responsabilidades, demandas, penas, pérdidas, juicios, pleitos y los costos incidente además, incluyendo costos de defensa, de acuerdo judicial, y de honorarios razonables del abogado, que pueden ser incurridos en, o como resultado de, la muerte o herida personal a cualquier persona, o daños a cualquier característica, propiedad, contaminación de la tierra o efectos ilícitos en esta Facilidad, causado entero o en parte por el cliente, sus empleados, o sus subcontratistas en botar basura en esta Facilidad. En el caso que el Cliente entrega, bota, basura (según lo determinado por Republic) en este Establecimiento basura inaceptable en los reglamentos de este Establecimiento, el Cliente se compromete asumir todos los costos y obligaciones con el retiro y/o la resolución de cualquier dano(s) causado por la entrega de tal basura inaceptable.



NON-HAZARDOUS WASTE MANIFEST

MANIFEST # 11738

GENERATOR INFORMATION

Generator Name: Tronox LLC
Address: P.O. Box 55
City: Henderson County: Clark
State: NV Zip: 89009
Site Location (if different): 560 W. Lake Mead
Henderson, NV 89015 (702) 592-7727

CUSTOMER/BILLING INFORMATION

Billing Name: NGE LLC c/o Northgate Environment Management
Address: 300 Frank Ogawa Plaza, Ste 510
City: Oakland County: Alameda
State: CA Zip: 94612

Table with 5 columns: Republic Services Approval #, Description of Waste, Volume/Weight, Expiration Date, Container Type. Row 1: 38251011244, Soil for disposal, 35 7/8 tons, 12-31-2011, Tractor with Dump Trailer(s).

*Attach Additional Sheet if necessary

I hereby certify that the above-described materials are non-hazardous wastes as defined by 40 CFR 261 or any applicable state law. Further, that the above named materials are properly classified, described, packaged, marked and labeled, and are in proper condition for transportation according to the applicable regulations of the Department of Transportation.

Susan Crowley (Signature)
Generator/Authorized Agent Name Signature Date Shipped

TRANSPORTER INFORMATION

Transporter Name: Las Vegas Paving DOT # 191949
Address: 4420 S. Decatur Truck Number: 2460
Las Vegas, NV 89103 Phone Number: (702) 353-4355

I certify no hazardous waste or other regulated substance was knowingly introduced to the waste while in my custody. The waste transported in this vehicle is the waste identified above, to the best of my knowledge.

Greta Honish (Signature)
Name of Authorized Agent Signature Date Delivered 10-3-10

DISPOSAL SITE INFORMATION

Site Name: Apex Regional Landfill Phone No. (702) 599-5920
Address: 13550 U.S. Hwy 93 Las Vegas, NV

I hereby acknowledge receipt of the above described materials
Holden, Se... (Signature)
Name (Print or Type) Signature Date Received 01 Oct 10

81 Environmental Tech
13550 N Highway 93
Las Vegas, NV 89165

Ticket Type: INBOUND INVOICE

Ticket Number: 1637
Date: 10/04/2010
Time In: 2:44 am
Time Out: 3:09 am

Customer: 001011 - NGE, LLC c/o Northgate Environ Mgmt

Vehicle/Container: 76811P
Contract: Northgate Env. On Site Soils 3825 11
Comment: 3825 10 11244

Gross Weight: 123,980 LB Manual In
Tare Weight: 53,420 LB Scale Out
Net Weight: 70560 LB
Net Tons: 35.28

BOL: 11741

Origin	Yards	Material	Billing Quantity
Not Applicable	0.00 YD	SW CONTAMINATED SOIL	35.28 TN

Driver: _____



Weighmaster: _____

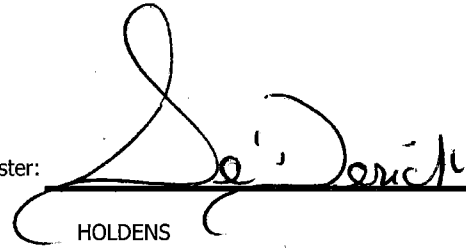

HOLDENS

Indemnification. Customer agrees, by signature above, to indemnify, hold harmless, and defend Republic Services, Inc., its subsidiaries, affiliates, employees, officers and directors from and against any and all liabilities, claims, penalties, forfeitures, suits and the costs and expenses incident thereto, including costs of defense, settlement, and reasonable attorney's fees, which may be incurred, as a result of death or injuries to any person, or damage to any property, contamination of or adverse effects on the environment, caused in whole or in part by the Customer, its employees, or subcontractors in disposing waste at this Facility. In the event Customer delivers Unacceptable Waste (as determined by Republic) Customer agrees to assume all expenses and obligations with the removal and/or resolution of any effects caused by the delivery of such Unacceptable Waste.

Indemnización. Cliente acuerda indemnizar, mantener inmune, y defender Republic Services, Inc., sus subsidiarios, compañías, divisiones, empleados, oficiales y directores contra de cualquiera y de todas responsabilidades, demandas, penas, pérdidas, juicios, pleitos y los costos incidente además, incluyendo costos de defensa, de acuerdo judicial, y de honorarios razonables del abogado, que pueden ser incurridos en, o como resultado de, la muerte o herida personal a cualquier persona, o daños a cualquier característica, propiedad, contaminación de la tierra o efectos ilícitos en esta Facilidad, causado entero o en parte por el cliente, sus empleados, o sus subcontratistas en botar basura en esta Facilidad. En el caso que el Cliente entrega, bota, basura (según lo determinado por Republic) en este Establecimiento basura inaceptable en los reglamentos de este Establecimiento, el Cliente se compromete asumir todos los costos y obligaciones con el retiro y/o la resolución de cualquier dano(s) causado por la entrega de tal basura inaceptable.



NON-HAZARDOUS WASTE MANIFEST

MANIFEST # 11741

GENERATOR INFORMATION

Generator Name: Tronox LLC

Address: P.O. Box 55

City: Henderson County: Clark

State: NV Zip: 89009

Site Location (if different): 560 W. Lake Mead

Henderson, NV 89015 (702) 592-7727

CUSTOMER/BILLING INFORMATION

Billing Name: NGE LLC c/o Northgate Environment Management

Address: 300 Frank Ogawa Plaza, Ste 510

City: Oakland County: Alameda

State: CA Zip: 94612

Republic Services Approval #	Description of Waste	Volume/Weight	Expiration Date	Container Type
38251011244	Soil for disposal	35 ²⁸ / ₃₁	12-31-2011	Tractor with Dump Trailer(s)
	RZ- _____ # _____			

*Attach Additional Sheet if necessary

I hereby certify that the above-described materials are non-hazardous wastes as defined by 40 CFR 261 or any applicable state law. Further, that the above named materials are properly classified, described, packaged, marked and labeled, and are in proper condition for transportation according to the applicable regulations of the Department of Transportation.

Susan Crowley

Susan Crowley

Generator/Authorized Agent Name

Signature

Date Shipped

TRANSPORTER INFORMATION

Transporter Name: Las Vegas Paving

DOT # 191949

Address: 4420 S. Decatur

Truck Number: 242

Las Vegas, NV 89103

Phone Number: (702) 353-4355

I certify no hazardous waste or other regulated substance was knowingly introduced to the waste while in my custody. The waste transported in this vehicle is the waste identified above, to the best of my knowledge.

STEVE WIXES

Steve Wixes

10-3-10

Name of Authorized Agent

Signature

Date Delivered

DISPOSAL SITE INFORMATION

Site Name: Apex Regional Landfill

Phone No. (702) 599-5920

Address: 13550 U.S. Hwy 93 Las Vegas, NV

I hereby acknowledge receipt of the above described materials.

Holden, Se' Jerald

Se' Jerald Holden

04 Oct 10

Name (Print or Type)

Signature

Date Received

81 Environmental Tech
13550 N Highway 93
Las Vegas, NV 89165

Ticket Type: INBOUND INVOICE

Ticket Number: 1638
Date: 10/04/2010
Time In: 2:45 am
Time Out: 3:10 am

Customer: 001011 - NGE, LLC c/o Northgate Environ Mgmt

Vehicle/Container: 86053P
Contract: Northgate Env. On Site Soils 3825 11
Comment: 3825 10 11244

Gross Weight: 127,420 LB Manual In
Tare Weight: 57,000 LB Manual Out
Net Weight: 70420 LB
Net Tons: 35.21

BOL: 11740

Origin	Yards	Material	Billing Quantity
Not Applicable	0.00 YD	SW CONTAMINATED SOIL	35.21 TN

Driver: _____



Weighmaster: _____

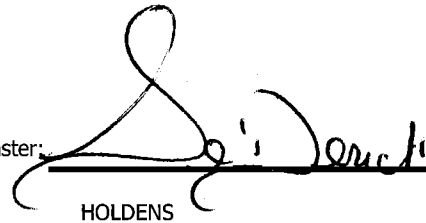

HOLDENS

Indemnification. Customer agrees, by signature above, to indemnify, hold harmless, and defend Republic Services, Inc., its subsidiaries, affiliates, employees, officers and directors from and against any and all liabilities, claims, penalties, forfeitures, suits and the costs and expenses incident thereto, including costs of defense, settlement, and reasonable attorney's fees, which may be incurred, as a result of death or injuries to any person, or damage to any property, contamination of or adverse effects on the environment, caused in whole or in part by the Customer, its employees, or subcontractors in disposing waste at this Facility. In the event Customer delivers Unacceptable Waste (as determined by Republic) Customer agrees to assume all expenses and obligations with the removal and/or resolution of any effects caused by the delivery of such Unacceptable Waste.

Indemnización. Cliente acuerda indemnizar, mantener inmune, y defender Republic Services, Inc., sus subsidiarios, compañías, divisiones, empleados, oficiales y directores contra de cualquiera y de todas responsabilidades, demandas, penas, pérdidas, juicios, pleitos y los costos incidente además, incluyendo costos de defensa, de acuerdo judicial, y de honorarios razonables del abogado, que pueden ser incurridos en, o como resultado de, la muerte o herida personal a cualquier persona, o daños a cualquier característica, propiedad, contaminación de la tierra o efectos ilícitos en esta Facilidad, causado entero o en parte por el cliente, sus empleados, o sus subcontratistas en botar basura en esta Facilidad. En el caso que el Cliente entrega, bota, basura (según lo determinado por Republic) en este Establecimiento basura inaceptable en los reglamentos de este Establecimiento, el Cliente se compromete asumir todos los costos y obligaciones con el retiro y/o la resolución de cualquier dano(s) causado por la entrega de tal basura inaceptable.



NON-HAZARDOUS WASTE MANIFEST

MANIFEST # 11740

GENERATOR INFORMATION

Generator Name: Tronox LLC
Address: P.O. Box 55
City: Henderson County: Clark
State: NV Zip: 89009
Site Location (if different): 560 W. Lake Mead
Henderson, NV 89015 (702) 592-7727

CUSTOMER/BILLING INFORMATION

Billing Name: NGE LLC c/o Northgate Environment Management
Address: 300 Frank Ogawa Plaza, Ste 510
City: Oakland County: Alameda
State: CA Zip: 94612

Table with 5 columns: Republic Services Approval #, Description of Waste, Volume/Weight, Expiration Date, Container Type. Row 1: 38251011244, Soil for disposal, 35 2/10n, 12-31-2011, Tractor with Dump Trailer(s).

*Attach Additional Sheet if necessary

I hereby certify that the above-described materials are non-hazardous wastes as defined by 40 CFR 261 or any applicable state law. Further, that the above named materials are properly classified, described, packaged, marked and labeled, and are in proper condition for transportation according to the applicable regulations of the Department of Transportation.

Susan Crowley
Generator/Authorized Agent Name Signature Date Shipped

TRANSPORTER INFORMATION

Transporter Name: Las Vegas Paving DOT # 191949
Address: 4420 S. Decatur Truck Number: 261
Las Vegas, NV 89103 Phone Number: (702) 353-4355

I certify no hazardous waste or other regulated substance was knowingly introduced to the waste while in my custody. The waste transported in this vehicle is the waste identified above, to the best of my knowledge.

Name of Authorized Agent Signature Date Delivered
Patrick Walsh Patrick Walsh 3 OCT 10

DISPOSAL SITE INFORMATION

Site Name: Apex Regional Landfill Phone No. (702) 599-5920
Address: 13550 U.S. Hwy 93 Las Vegas, NV

I hereby acknowledge receipt of the above described materials
Name (Print or Type) Signature Date Received
Holden, Se' Derrick Holden 04 Oct 10

81 Environmental Tech
13550 N Highway 93
Las Vegas, NV 89165

Ticket Type: INBOUND INVOICE

Ticket Number: 1639
Date: 10/04/2010
Time In: 2:46 am
Time Out: 3:13 am

Customer: 001011 - NGE, LLC c/o Northgate Environ Mgmt

Vehicle/Container: 82418P
Contract: Northgate Env. On Site Soils 3825 11
Comment: 3825 10 11244

Gross Weight: 141,020 LB Manual In
Tare Weight: 60,080 LB Scale Out
Net Weight: 80940 LB
Net Tons: 40.47

BOL: 11737

Origin	Yards	Material	Billing	Quantity
Not Applicable	0.00 YD	SW CONTAMINATED SOIL	40.47	TN

Driver:



Weighmaster:

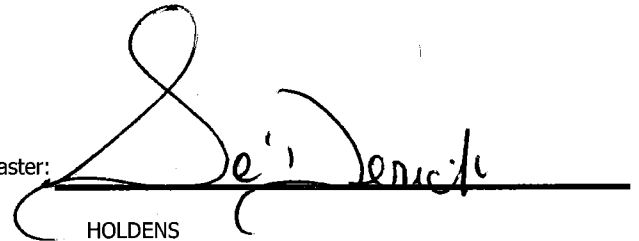

HOLDENS

Indemnification. Customer agrees, by signature above, to indemnify, hold harmless, and defend Republic Services, Inc., its subsidiaries, affiliates, employees, officers and directors from and against any and all liabilities, claims, penalties, forfeitures, suits and the costs and expenses incident thereto, including costs of defense, settlement, and reasonable attorney's fees, which may be incurred, as a result of death or injuries to any person, or damage to any property, contamination of or adverse effects on the environment, caused in whole or in part by the Customer, its employees, or subcontractors in disposing waste at this Facility. In the event Customer delivers Unacceptable Waste (as determined by Republic) Customer agrees to assume all expenses and obligations with the removal and/or resolution of any effects caused by the delivery of such Unacceptable Waste.

Indemnización. Cliente acuerda indemnizar, mantener inmune, y defender Republic Services, Inc., sus subsidiarios, compañías, divisiones, empleados, oficiales y directores contra de cualquiera y de todas responsabilidades, demandas, penas, pérdidas, juicios, pleitos y los costos incidente además, incluyendo costos de defensa, de acuerdo judicial, y de honorarios razonables del abogado, que pueden ser incurridos en, o como resultado de, la muerte o herida personal a cualquier persona, o daños a cualquier característica, propiedad, contaminación de la tierra o efectos ilícitos en esta Facilidad, causado entero o en parte por el cliente, sus empleados, o sus subcontratistas en botar basura en esta Facilidad. En el caso que el Cliente entrega, bota, basura (según lo determinado por Republic) en este Establecimiento basura inaceptable en los reglamentos de este Establecimiento, el Cliente se compromete asumir todos los costos y obligaciones con el retiro y/o la resolución de cualquier dano(s) causado por la entrega de tal basura inaceptable.



NON-HAZARDOUS WASTE MANIFEST

MANIFEST # 11737

GENERATOR INFORMATION

Generator Name: Tronox LLC
Address: P.O. Box 55
City: Henderson County: Clark
State: NV Zip: 89009
Site Location (if different): 560 W. Lake Mead
Henderson, NV 89015 (702) 592-7727

CUSTOMER/BILLING INFORMATION

Billing Name: NGE LLC c/o Northgate Environment Management
Address: 300 Frank Ogawa Plaza, Ste 510
City: Oakland County: Alameda
State: CA Zip: 94612

Table with 5 columns: Republic Services Approval #, Description of Waste, Volume/Weight, Expiration Date, Container Type. Row 1: 38251011244, Soil for disposal, 40 47/100, 12-31-2011, Tractor with Dump Trailer(s). Row 2: RZ- #

*Attach Additional Sheet if necessary

I hereby certify that the above-described materials are non-hazardous wastes as defined by 40 CFR 261 or any applicable state law. Further, that the above named materials are properly classified, described, packaged, marked and labeled, and are in proper condition for transportation according to the applicable regulations of the Department of Transportation.

Susan Crowley
Generator/Authorized Agent Name Signature Date Shipped

TRANSPORTER INFORMATION

Transporter Name: Las Vegas Paving DOT # 191949
Address: 4420 S. Decatur Truck Number: 220
Las Vegas, NV 89103 Phone Number: (702) 353-4355

I certify no hazardous waste or other regulated substance was knowingly introduced to the waste while in my custody. The waste transported in this vehicle is the waste identified above, to the best of my knowledge.

STEVE TAYLOR
Name of Authorized Agent Signature Date Delivered 10-3-10

DISPOSAL SITE INFORMATION

Site Name: Apex Regional Landfill Phone No. (702) 599-5920
Address: 13550 U.S. Hwy 93 Las Vegas, NV

I hereby acknowledge receipt of the above described materials
Name (Print or Type) Signature Date Received 04 Oct 10

81 Environmental Tech
13550 N Highway 93
Las Vegas, NV 89165

Ticket Type: INBOUND INVOICE

Ticket Number: 1640
Date: 10/04/2010
Time In: 2:58 am
Time Out: 3:23 am

Customer: 001011 - NGE, LLC c/o Northgate Environ Mgmt

Vehicle/Container: 68263P
Contract: Northgate Env. On Site Soils 3825 11
Comment: 3825 10 11244

Gross Weight: 125,960 LB Manual In
Tare Weight: 53,240 LB Scale Out
Net Weight: 72720 LB
Net Tons: 36.36

BOL: 11743

Origin	Yards	Material	Billing Quantity
Not Applicable	0.00 YD	SW CONTAMINATED SOIL	36.36 TN

Driver:

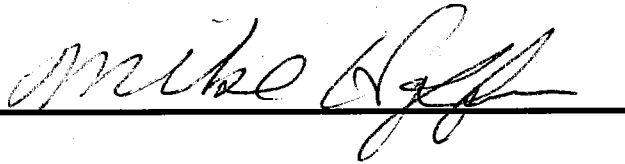

Weighmaster:

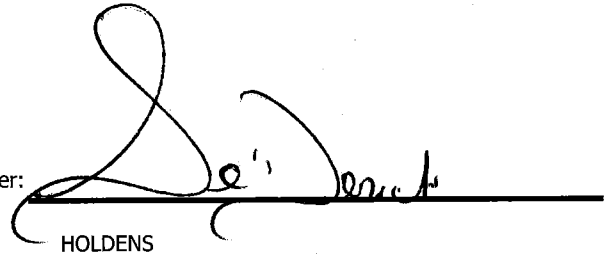

HOLDENS

Indemnification. Customer agrees, by signature above, to indemnify, hold harmless, and defend Republic Services, Inc., its subsidiaries, affiliates, employees, officers and directors from and against any and all liabilities, claims, penalties, forfeitures, suits and the costs and expenses incident thereto, including costs of defense, settlement, and reasonable attorney's fees, which may be incurred, as a result of death or injuries to any person, or damage to any property, contamination of or adverse effects on the environment, caused in whole or in part by the Customer, its employees, or subcontractors in disposing waste at this Facility. In the event Customer delivers Unacceptable Waste (as determined by Republic) Customer agrees to assume all expenses and obligations with the removal and/or resolution of any effects caused by the delivery of such Unacceptable Waste.

Indemnización. Cliente acuerda indemnizar, mantener inmune, y defender Republic Services, Inc., sus subsidiarios, compañías, divisiones, empleados, oficiales y directores contra de cualquiera y de todas responsabilidades, demandas, penas, pérdidas, juicios, pleitos y los costos incidente además, incluyendo costos de defensa, de acuerdo judicial, y de honorarios razonables del abogado, que pueden ser incurridos en, o como resultado de, la muerte o herida personal a cualquier persona, o daños a cualquier característica, propiedad, contaminación de la tierra o efectos ilícitos en esta Facilidad, causado entero o en parte por el cliente, sus empleados, o sus subcontratistas en botar basura en esta Facilidad. En el caso que el Cliente entrega, bota, basura (según lo determinado por Republic) en este Establecimiento basura inaceptable en los reglamentos de este Establecimiento, el Cliente se compromete asumir todos los costos y obligaciones con el retiro y/o la resolución de cualquier dano(s) causado por la entrega de tal basura inaceptable.



NON-HAZARDOUS WASTE MANIFEST

MANIFEST # 11743

GENERATOR INFORMATION

Generator Name: Tronox LLC

Address: P.O. Box 55

City: Henderson County: Clark

State: NV Zip: 89009

Site Location (if different): 560 W. Lake Mead

Henderson, NV 89015 (702) 592-7727

CUSTOMER/BILLING INFORMATION

Billing Name: NGE LLC c/o Northgate Environment Management

Address: 300 Frank Ogawa Plaza, Ste 510

City: Oakland County: Alameda

State: CA Zip: 94612

Republic Services Approval #	Description of Waste	Volume/Weight	Expiration Date	Container Type
38251011244	Soil for disposal	36 ³⁰ / ₇₀ ton	12-31-2011	Tractor with Dump Trailer(s)
	RZ- #			

*Attach Additional Sheet if necessary

I hereby certify that the above-described materials are non-hazardous wastes as defined by 40 CFR 261 or any applicable state law. Further, that the above named materials are properly classified, described, packaged, marked and labeled, and are in proper condition for transportation according to the applicable regulations of the Department of Transportation.

Susan Crowley Generator/Authorized Agent Name Signature Date Shipped

TRANSPORTER INFORMATION

Transporter Name: Las Vegas Paving

DOT # 191949

Address: 4420 S. Decatur

Truck Number: 2711

Las Vegas, NV 89103

Phone Number: (702) 353-4355

I certify no hazardous waste or other regulated substance was knowingly introduced to the waste while in my custody. The waste transported in this vehicle is the waste identified above, to the best of my knowledge.

Mike Heffern Mike Heffern Name of Authorized Agent Signature Date Delivered 10-3-10

DISPOSAL SITE INFORMATION

Site Name: Apex Regional Landfill

Phone No. (702) 599-5920

Address: 13550 U.S. Hwy 93 Las Vegas, NV

I hereby acknowledge receipt of the above described materials

Halden, Sa Derick Halden Name (Print or Type) Signature Date Received 04 Oct 10

81 Environmental Tech
13550 N Highway 93
Las Vegas, NV 89165

Ticket Type: INBOUND INVOICE

Ticket Number: 1641
Date: 10/04/2010
Time In: 3:10 am
Time Out: 3:32 am

Customer: 001011 - NGE, LLC c/o Northgate Environ Mgmt

Vehicle/Container: 76810P
Contract: Northgate Env. On Site Soils 3825 11
Comment: 3825 10 11244

Gross Weight: 123,780 LB Manual In
Tare Weight: 57,000 LB Scale Out
Net Weight: 66780 LB
Net Tons: 33.39

BOL: 11742

Origin	Yards	Material	Billing	Quantity
Not Applicable	0.00 YD	SW CONTAMINATED SOIL	33.39	TN

Driver:

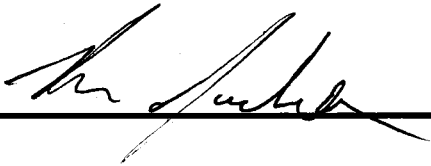

Weighmaster:

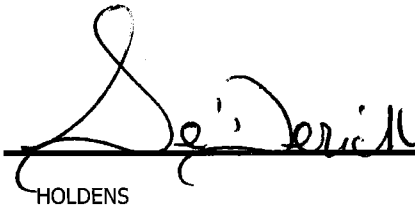
HOLDENS

Indemnification. Customer agrees, by signature above, to indemnify, hold harmless, and defend Republic Services, Inc., its subsidiaries, affiliates, employees, officers and directors from and against any and all liabilities, claims, penalties, forfeitures, suits and the costs and expenses incident thereto, including costs of defense, settlement, and reasonable attorney's fees, which may be incurred, as a result of death or injuries to any person, or damage to any property, contamination of or adverse effects on the environment, caused in whole or in part by the Customer, its employees, or subcontractors in disposing waste at this Facility. In the event Customer delivers Unacceptable Waste (as determined by Republic) Customer agrees to assume all expenses and obligations with the removal and/or resolution of any effects caused by the delivery of such Unacceptable Waste.

Indemnización. Cliente acuerda indemnizar, mantener inmune, y defender Republic Services, Inc., sus subsidiarios, compañías, divisiones, empleados, oficiales y directores contra de cualquiera y de todas responsabilidades, demandas, penas, pérdidas, juicios, pleitos y los costos incidente además, incluyendo costos de defensa, de acuerdo judicial, y de honorarios razonables del abogado, que pueden ser incurridos en, o como resultado de, la muerte o herida personal a cualquier persona, o daños a cualquier característica, propiedad, contaminación de la tierra o efectos ilícitos en esta Facilidad, causado entero o en parte por el cliente, sus empleados, o sus subcontratistas en botar basura en esta Facilidad. En el caso que el Cliente entrega, bota, basura (según lo determinado por Republic) en este Establecimiento basura inaceptable en los reglamentos de este Establecimiento, el Cliente se compromete asumir todos los costos y obligaciones con el retiro y/o la resolución de cualquier dano(s) causado por la entrega de tal basura inaceptable.



NON-HAZARDOUS WASTE MANIFEST

MANIFEST # 11742

GENERATOR INFORMATION

Generator Name: Tronox LLC
Address: P.O. Box 55
City: Henderson County: Clark
State: NV Zip: 89009
Site Location (if different): 560 W. Lake Mead
Henderson, NV 89015 (702) 592-7727

CUSTOMER/BILLING INFORMATION

Billing Name: NGE LLC c/o Northgate Environment Management
Address: 300 Frank Ogawa Plaza, Ste 510
City: Oakland County: Alameda
State: CA Zip: 94612

Table with 5 columns: Republic Services Approval #, Description of Waste, Volume/Weight, Expiration Date, Container Type. Row 1: 38251011244, Soil for disposal, 33 3/4 ton, 12-31-2011, Tractor with Dump Trailer(s).

*Attach Additional Sheet if necessary

I hereby certify that the above-described materials are non-hazardous wastes as defined by 40 CFR 261 or any applicable state law. Further, that the above named materials are properly classified, described, packaged, marked and labeled, and are in proper condition for transportation according to the applicable regulations of the Department of Transportation.

Susan Crowley (Signature)
Generator/Authorized Agent Name Signature Date Shipped

TRANSPORTER INFORMATION

Transporter Name: Las Vegas Paving DOT # 191949
Address: 4420 S. Decatur Truck Number:
Las Vegas, NV 89103 Phone Number: (702) 353-4355

I certify no hazardous waste or other regulated substance was knowingly introduced to the waste while in my custody. The waste transported in this vehicle is the waste identified above, to the best of my knowledge.

Ken Jackson (Signature) Date Delivered 10-3-2010
Name of Authorized Agent Signature Date Delivered

DISPOSAL SITE INFORMATION

Site Name: Apex Regional Landfill Phone No. (702) 599-5920
Address: 13550 U.S. Hwy 93 Las Vegas, NV

I hereby acknowledge receipt of the above described materials
Holden, Se' Derrick (Signature) Date Received 04 Oct 10
Name (Print or Type) Signature Date Received

81 Environmental Tech
13550 N Highway 93
Las Vegas, NV 89165

Ticket Type: INBOUND INVOICE

Ticket Number: 1642
Date: 10/04/2010
Time In: 3:22 am
Time Out: 3:43 am

Customer: 001011 - NGE, LLC c/o Northgate Environ Mgmt

Vehicle/Container: 82290P

Contract: Northgate Env. On Site Soils 3825 11

Comment: ~~431~~ 3825 10 11244

Gross Weight: 125,680 LB Manual In
Tare Weight: 53,380 LB Scale Out
Net Weight: 72300 LB
Net Tons: 36.15

BOL: 11746

Origin	Yards	Material	Billing	Quantity
Not Applicable	0.00 YD	SW CONTAMINATED SOIL	36.15	TN

Driver: _____

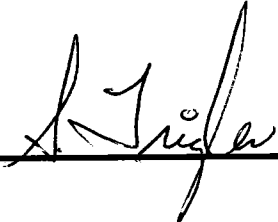

Weighmaster: _____



HOLDENS

Indemnification. Customer agrees, by signature above, to indemnify, hold harmless, and defend Republic Services, Inc., its subsidiaries, affiliates, employees, officers and directors from and against any and all liabilities, claims, penalties, forfeitures, suits and the costs and expenses incident thereto, including costs of defense, settlement, and reasonable attorney's fees, which may be incurred, as a result of death or injuries to any person, or damage to any property, contamination of or adverse effects on the environment, caused in whole or in part by the Customer, its employees, or subcontractors in disposing waste at this Facility. In the event Customer delivers Unacceptable Waste (as determined by Republic) Customer agrees to assume all expenses and obligations with the removal and/or resolution of any effects caused by the delivery of such Unacceptable Waste.

Indemnización. Cliente acuerda indemnizar, mantener inmune, y defender Republic Services, Inc., sus subsidiarios, compañías, divisiones, empleados, oficiales y directores contra de cualquiera y de todas responsabilidades, demandas, penas, pérdidas, juicios, pleitos y los costos incidente además, incluyendo costos de defensa, de acuerdo judicial, y de honorarios razonables del abogado, que pueden ser incurridos en, o como resultado de, la muerte o herida personal a cualquier persona, o daños a cualquier característica, propiedad, contaminación de la tierra o efectos ilícitos en esta Facilidad, causado entero o en parte por el cliente, sus empleados, o sus subcontratistas en botar basura en esta Facilidad. En el caso que el Cliente entrega, bota, basura (según lo determinado por Republic) en este Establecimiento basura inaceptable en los reglamentos de este Establecimiento, el Cliente se compromete asumir todos los costos y obligaciones con el retiro y/o la resolución de cualquier dano(s) causado por la entrega de tal basura inaceptable.



NON-HAZARDOUS WASTE MANIFEST

MANIFEST # 11746

GENERATOR INFORMATION

Generator Name: Tronox LLC
Address: P.O. Box 55
City: Henderson County: Clark
State: NV Zip: 89009
Site Location (if different): 560 W. Lake Mead
Henderson, NV 89015 (702) 592-7727

CUSTOMER/BILLING INFORMATION

Billing Name: NGE LLC c/o Northgate Environment Management
Address: 300 Frank Ogawa Plaza, Ste 510
City: Oakland County: Alameda
State: CA Zip: 94612

Table with 5 columns: Republic Services Approval #, Description of Waste, Volume/Weight, Expiration Date, Container Type. Row 1: 38251011244, Soil for disposal, 36 1/2 tons, 12-31-2011, Tractor with Dump Trailer(s).

*Attach Additional Sheet if necessary

I hereby certify that the above-described materials are non-hazardous wastes as defined by 40 CFR 261 or any applicable state law. Further, that the above named materials are properly classified, described, packaged, marked and labeled, and are in proper condition for transportation according to the applicable regulations of the Department of Transportation.

Susan Crowley
Generator/Authorized Agent Name Signature Date Shipped

TRANSPORTER INFORMATION

Transporter Name: Las Vegas Paving DOT # 191949
Address: 4420 S. Decatur Truck Number: 01
Las Vegas, NV 89103 Phone Number: (702) 353-4355

I certify no hazardous waste or other regulated substance was knowingly introduced to the waste while in my custody. The waste transported in this vehicle is the waste identified above, to the best of my knowledge.

TRIGER, STEVE
Name of Authorized Agent Signature Date Delivered 10-3-10

DISPOSAL SITE INFORMATION

Site Name: Apex Regional Landfill Phone No. (702) 599-5920
Address: 13550 U.S. Hwy 93 Las Vegas, NV

I hereby acknowledge receipt of the above described materials
Name (Print or Type) Signature Date Received 01 Oct 10

81 Environmental Tech
13550 N Highway 93
Las Vegas, NV 89165

Ticket Type: INBOUND INVOICE

Ticket Number: 1643
Date: 10/04/2010
Time In: 3:23 am
Time Out: 3:47 am

Customer: 001011 - NGE, LLC c/o Northgate Environ Mgmt

Vehicle/Container: 44161A
Contract: Northgate Env. On Site Soils 3825 11
Comment: 3825 10 11244

Gross Weight: 136,940 LB Manual In
Tare Weight: 52,580 LB Scale Out
Net Weight: 84360 LB
Net Tons: 42.18

BOL: 11744

Origin	Yards	Material	Billing Quantity
Not Applicable	0.00 YD	SW CONTAMINATED SOIL	42.18 TN

Driver: _____

Weighmaster: _____

HOLDENS

Indemnification. Customer agrees, by signature above, to indemnify, hold harmless, and defend Republic Services, Inc., its subsidiaries, affiliates, employees, officers and directors from and against any and all liabilities, claims, penalties, forfeitures, suits and the costs and expenses incident thereto, including costs of defense, settlement, and reasonable attorney's fees, which may be incurred, as a result of death or injuries to any person, or damage to any property, contamination of or adverse effects on the environment, caused in whole or in part by the Customer, its employees, or subcontractors in disposing waste at this Facility. In the event Customer delivers Unacceptable Waste (as determined by Republic) Customer agrees to assume all expenses and obligations with the removal and/or resolution of any effects caused by the delivery of such Unacceptable Waste.

Indemnización. Cliente acuerda indemnizar, mantener inmune, y defender Republic Services, Inc., sus subsidiarios, compañías, divisiones, empleados, oficiales y directores contra de cualquiera y de todas responsabilidades, demandas, penas, pérdidas, juicios, pleitos y los costos incidente además, incluyendo costos de defensa, de acuerdo judicial, y de honorarios razonables del abogado, que pueden ser incurridos en, o como resultado de, la muerte o herida personal a cualquier persona, o daños a cualquier característica, propiedad, contaminación de la tierra o efectos ilícitos en esta Facilidad, causado entero o en parte por el cliente, sus empleados, o sus subcontratistas en botar basura en esta Facilidad. En el caso que el Cliente entrega, bota, basura (según lo determinado por Republic) en este Establecimiento basura inaceptable en los reglamentos de este Establecimiento, el Cliente se compromete asumir todos los costos y obligaciones con el retiro y/o la resolución de cualquier dano(s) causado por la entrega de tal basura inaceptable.



NON-HAZARDOUS WASTE MANIFEST

MANIFEST # 11744

GENERATOR INFORMATION

Generator Name: Tronox LLC
Address: P.O. Box 55
City: Henderson County: Clark
State: NV Zip: 89009
Site Location (if different): 560 W. Lake Mead
Henderson, NV 89015 (702) 592-7727

CUSTOMER/BILLING INFORMATION

Billing Name: NGE LLC c/o Northgate Environment Management
Address: 300 Frank Ogawa Plaza, Ste 510
City: Oakland County: Alameda
State: CA Zip: 94612

Table with 5 columns: Republic Services Approval #, Description of Waste, Volume/Weight, Expiration Date, Container Type. Row 1: 38251011244, Soil for disposal, 412 13/107, 12-31-2011, Tractor with Dump Trailer(s).

*Attach Additional Sheet if necessary

I hereby certify that the above-described materials are non-hazardous wastes as defined by 40 CFR 261 or any applicable state law. Further, that the above named materials are properly classified, described, packaged, marked and labeled, and are in proper condition for transportation according to the applicable regulations of the Department of Transportation.

Susan Crowley (Signature)
Generator/Authorized Agent Name Signature Date Shipped

TRANSPORTER INFORMATION

Transporter Name: Las Vegas Paving DOT # 191949
Address: 4420 S. Decatur Truck Number: K005
Las Vegas, NV 89103 Phone Number: (702) 353-4355

I certify no hazardous waste or other regulated substance was knowingly introduced to the waste while in my custody. The waste transported in this vehicle is the waste identified above, to the best of my knowledge.

R. Arroyo (Signature)
Name of Authorized Agent Signature Date Delivered 10-3-10

DISPOSAL SITE INFORMATION

Site Name: Apex Regional Landfill Phone No. (702) 599-5920
Address: 13550 U.S. Hwy 93 Las Vegas, NV

I hereby acknowledge receipt of the above described materials
Holden, Se Derrick (Signature)
Name (Print or Type) Signature Date Received 04 Oct 10

81 Environmental Tech
13550 N Highway 93
Las Vegas, NV 89165

Ticket Type: INBOUND INVOICE

Ticket Number: 1644
Date: 10/04/2010
Time In: 3:24 am
Time Out: 3:47 am

Customer: 001011 - NGE, LLC c/o Northgate Environ Mgmt

Vehicle/Container: 86113P
Contract: Northgate Env. On Site Soils 3825 11
Comment: 3825 10 11244

Gross Weight: 134,320 LB Manual In
Tare Weight: 55,260 LB Manual Out
Net Weight: 79060 LB
Net Tons: 39.53

BOL: 11745

Origin	Yards	Material	Billing	Quantity
Not Applicable	0.00 YD	SW CONTAMINATED SOIL	39.53	TN

Driver:

J. A. H.

Weighmaster:

[Signature]
HOLDENS

Indemnification. Customer agrees, by signature above, to indemnify, hold harmless, and defend Republic Services, Inc., its subsidiaries, affiliates, employees, officers and directors from and against any and all liabilities, claims, penalties, forfeitures, suits and the costs and expenses incident thereto, including costs of defense, settlement, and reasonable attorney's fees, which may be incurred, as a result of death or injuries to any person, or damage to any property, contamination of or adverse effects on the environment, caused in whole or in part by the Customer, its employees, or subcontractors in disposing waste at this Facility. In the event Customer delivers Unacceptable Waste (as determined by Republic) Customer agrees to assume all expenses and obligations with the removal and/or resolution of any effects caused by the delivery of such Unacceptable Waste.

Indemnización. Cliente acuerda indemnizar, mantener inmune, y defender Republic Services, Inc., sus subsidiarios, compañías, divisiones, empleados, oficiales y directores contra de cualquiera y de todas responsabilidades, demandas, penas, pérdidas, juicios, pleitos y los costos incidente además, incluyendo costos de defensa, de acuerdo judicial, y de honorarios razonables del abogado, que pueden ser incurridos en, o como resultado de, la muerte o herida personal a cualquier persona, o daños a cualquier característica, propiedad, contaminación de la tierra o efectos ilícitos en esta Facilidad, causado entero o en parte por el cliente, sus empleados, o sus subcontratistas en botar basura en esta Facilidad. En el caso que el Cliente entrega, bota, basura (según lo determinado por Republic) en este Establecimiento basura inaceptable en los reglamentos de este Establecimiento, el Cliente se compromete asumir todos los costos y obligaciones con el retiro y/o la resolución de cualquier dano(s) causado por la entrega de tal basura inaceptable.



NON-HAZARDOUS WASTE MANIFEST

MANIFEST # 11745

GENERATOR INFORMATION

Generator Name: Tronox LLC

Address: P.O. Box 55

City: Henderson County: Clark

State: NV Zip: 89009

Site Location (if different): 560 W. Lake Mead

Henderson, NV 89015 (702) 592-7727

CUSTOMER/BILLING INFORMATION

Billing Name: NGE LLC c/o Northgate Environment Management

Address: 300 Frank Ogawa Plaza, Ste 510

City: Oakland County: Alameda

State: CA Zip: 94612

Republic Services Approval #	Description of Waste	Volume/Weight	Expiration Date	Container Type
38251011244	Soil for disposal	39 ⁵³ / ₁₀₀ ton	12-31-2011	Tractor with Dump Trailer(s)
	RZ- _____ # _____			

*Attach Additional Sheet if necessary

I hereby certify that the above-described materials are non-hazardous wastes as defined by 40 CFR 261 or any applicable state law. Further, that the above named materials are properly classified, described, packaged, marked and labeled, and are in proper condition for transportation according to the applicable regulations of the Department of Transportation.

Susan Crowley

Generator/Authorized Agent Name

Signature

Date Shipped

TRANSPORTER INFORMATION

Transporter Name: Las Vegas Paving

DOT # 191949

Address: 4420 S. Decatur

Truck Number: K0019/7

Las Vegas, NV 89103

Phone Number: (702) 353-4355

I certify no hazardous waste or other regulated substance was knowingly introduced to the waste while in my custody. The waste transported in this vehicle is the waste identified above, to the best of my knowledge.

ALBERTO HERRERA

OCT 3, 2010

Name of Authorized Agent

Signature

Date Delivered

DISPOSAL SITE INFORMATION

Site Name: Apex Regional Landfill

Phone No. (702) 599-5920

Address: 13550 U.S. Hwy 93 Las Vegas, NV

I hereby acknowledge receipt of the above described materials

Holden, Sa'Derrick

Oct 4, 2010

Name (Print or Type)

Signature

Date Received

81 Environmental Tech
13550 N Highway 93
Las Vegas, NV 89165

Ticket Type: INBOUND INVOICE

Ticket Number: 1645
Date: 10/04/2010
Time In: 3:31 am
Time Out: 4:02 am

Customer: 001011 - NGE, LLC c/o Northgate Environ Mgmt

Vehicle/Container: 44166A
Contract: Northgate Env. On Site Soils 3825 11
Comment: 3825 10 11244

Gross Weight: 142,580 LB Manual In
Tare Weight: 56,900 LB Scale Out
Net Weight: 85680 LB
Net Tons: 42.84

BOL: 11747

Origin	Yards	Material	Billing	Quantity
Not Applicable	0.00 YD	SW CONTAMINATED SOIL	42.84	TN

Driver:

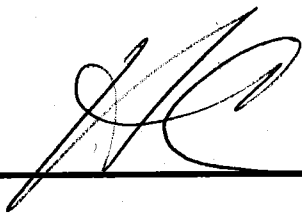

Weighmaster:

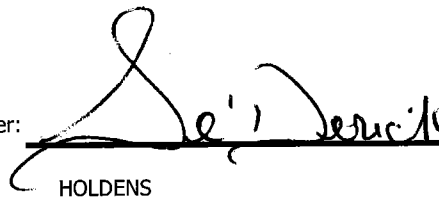

HOLDENS

Indemnification. Customer agrees, by signature above, to indemnify, hold harmless, and defend Republic Services, Inc., its subsidiaries, affiliates, employees, officers and directors from and against any and all liabilities, claims, penalties, forfeitures, suits and the costs and expenses incident thereto, including costs of defense, settlement, and reasonable attorney's fees, which may be incurred, as a result of death or injuries to any person, or damage to any property, contamination of or adverse effects on the environment, caused in whole or in part by the Customer, its employees, or subcontractors in disposing waste at this Facility. In the event Customer delivers Unacceptable Waste (as determined by Republic) Customer agrees to assume all expenses and obligations with the removal and/or resolution of any effects caused by the delivery of such Unacceptable Waste.

Indemnización. Cliente acuerda indemnizar, mantener inmune, y defender Republic Services, Inc., sus subsidiarios, compañías, divisiones, empleados, oficiales y directores contra de cualquiera y de todas responsabilidades, demandas, penas, pérdidas, juicios, pleitos y los costos incidente además, incluyendo costos de defensa, de acuerdo judicial, y de honorarios razonables del abogado, que pueden ser incurridos en, o como resultado de, la muerte o herida personal a cualquier persona, o daños a cualquier característica, propiedad, contaminación de la tierra o efectos ilícitos en esta Facilidad, causado entero o en parte por el cliente, sus empleados, o sus subcontratistas en botar basura en esta Facilidad. En el caso que el Cliente entrega, bota, basura (según lo determinado por Republic) en este Establecimiento basura inaceptable en los reglamentos de este Establecimiento, el Cliente se compromete asumir todos los costos y obligaciones con el retiro y/o la resolución de cualquier dano(s) causado por la entrega de tal basura inaceptable.



NON-HAZARDOUS WASTE MANIFEST

MANIFEST # 11747

GENERATOR INFORMATION

Generator Name: Tronox LLC
Address: P.O. Box 55
City: Henderson County: Clark
State: NV Zip: 89009
Site Location (if different): 560 W. Lake Mead
Henderson, NV 89015 (702) 592-7727

CUSTOMER/BILLING INFORMATION

Billing Name: NGE LLC c/o Northgate Environment Management
Address: 300 Frank Ogawa Plaza, Ste 510
City: Oakland County: Alameda
State: CA Zip: 94612

Table with 5 columns: Republic Services Approval #, Description of Waste, Volume/Weight, Expiration Date, Container Type. Row 1: 38251011244, Soil for disposal, 42 94/100, 12-31-2011, Tractor with Dump Trailer(s). Row 2: RZ- #

*Attach Additional Sheet if necessary

I hereby certify that the above-described materials are non-hazardous wastes as defined by 40 CFR 261 or any applicable state law. Further, that the above named materials are properly classified, described, packaged, marked and labeled, and are in proper condition for transportation according to the applicable regulations of the Department of Transportation.

Susan Crowley (Signature)
Generator/Authorized Agent Name Signature Date Shipped

TRANSPORTER INFORMATION

Transporter Name: Las Vegas Paving DOT # 191949
Address: 4420 S. Decatur Truck Number: K002
Las Vegas, NV 89103 Phone Number: (702) 353-4355

I certify no hazardous waste or other regulated substance was knowingly introduced to the waste while in my custody. The waste transported in this vehicle is the waste identified above, to the best of my knowledge.

Hugo (Signature) (Signature) 10-3-10
Name of Authorized Agent Signature Date Delivered

DISPOSAL SITE INFORMATION

Site Name: Apex Regional Landfill Phone No. (702) 599-5920
Address: 13550 U.S. Hwy 93 Las Vegas, NV

I hereby acknowledge receipt of the above described materials
Holden, S. Derrick (Signature) 01 Oct 10
Name (Print or Type) Signature Date Received

81 Environmental Tech
13550 N Highway 93
Las Vegas, NV 89165

Ticket Type: INBOUND INVOICE

Ticket Number: 1646
Date: 10/04/2010
Time In: 3:34 am
Time Out: 4:04 am

Customer: 001011 - NGE, LLC c/o Northgate Environ Mgmt

Vehicle/Container: 43099A
Contract: Northgate Env. On Site Soils 3825 11
Comment: 3825 10 11244

Gross Weight: 123,200 LB Manual In
Tare Weight: 54,260 LB Manual Out
Net Weight: 68940 LB
Net Tons: 34.47

BOL: 11749

Origin	Yards	Material	Billing	Quantity
Not Applicable	0.00 YD	SW CONTAMINATED SOIL	34.47	TN

Driver: _____

Weighmaster: _____

HOLDENS

Indemnification. Customer agrees, by signature above, to indemnify, hold harmless, and defend Republic Services, Inc., its subsidiaries, affiliates, employees, officers and directors from and against any and all liabilities, claims, penalties, forfeitures, suits and the costs and expenses incident thereto, including costs of defense, settlement, and reasonable attorney's fees, which may be incurred, as a result of death or injuries to any person, or damage to any property, contamination of or adverse effects on the environment, caused in whole or in part by the Customer, its employees, or subcontractors in disposing waste at this Facility. In the event Customer delivers Unacceptable Waste (as determined by Republic) Customer agrees to assume all expenses and obligations with the removal and/or resolution of any effects caused by the delivery of such Unacceptable Waste.

Indemnización. Cliente acuerda indemnizar, mantener inmune, y defender Republic Services, Inc., sus subsidiarios, compañías, divisiones, empleados, oficiales y directores contra de cualquiera y de todas responsabilidades, demandas, penas, pérdidas, juicios, pleitos y los costos incidente además, incluyendo costos de defensa, de acuerdo judicial, y de honorarios razonables del abogado, que pueden ser incurridos en, o como resultado de, la muerte o herida personal a cualquier persona, o daños a cualquier característica, propiedad, contaminación de la tierra o efectos ilícitos en esta Facilidad, causado entero o en parte por el cliente, sus empleados, o sus subcontratistas en botar basura en esta Facilidad. En el caso que el Cliente entrega, bota, basura (según lo determinado por Republic) en este Establecimiento basura inaceptable en los reglamentos de este Establecimiento, el Cliente se compromete asumir todos los costos y obligaciones con el retiro y/o la resolución de cualquier dano(s) causado por la entrega de tal basura inaceptable.



NON-HAZARDOUS WASTE MANIFEST

MANIFEST # 11749

GENERATOR INFORMATION

Generator Name: Tronox LLC
Address: P.O. Box 55
City: Henderson County: Clark
State: NV Zip: 89009
Site Location (if different): 560 W. Lake Mead
Henderson, NV 89015 (702) 592-7727

CUSTOMER/BILLING INFORMATION

Billing Name: NGE LLC c/o Northgate Environment Management
Address: 300 Frank Ogawa Plaza, Ste 510
City: Oakland County: Alameda
State: CA Zip: 94612

Table with 5 columns: Republic Services Approval #, Description of Waste, Volume/Weight, Expiration Date, Container Type. Row 1: 38251011244, Soil for disposal, 34 47/100, 12-31-2011, Tractor with Dump Trailer(s). Row 2: RZ- #

*Attach Additional Sheet if necessary

I hereby certify that the above-described materials are non-hazardous wastes as defined by 40 CFR 261 or any applicable state law. Further, that the above named materials are properly classified, described, packaged, marked and labeled, and are in proper condition for transportation according to the applicable regulations of the Department of Transportation.

Susan Crowley
Generator/Authorized Agent Name Signature Date Shipped

TRANSPORTER INFORMATION

Transporter Name: Las Vegas Paving DOT # 191949
Address: 4420 S. Decatur Truck Number: Bessock #6
Las Vegas, NV 89103 Phone Number: (702) 353-4355

I certify no hazardous waste or other regulated substance was knowingly introduced to the waste while in my custody. The waste transported in this vehicle is the waste identified above, to the best of my knowledge.

James Lawrence
Name of Authorized Agent Signature Date Delivered 10/4/10

DISPOSAL SITE INFORMATION

Site Name: Apex Regional Landfill Phone No. (702) 599-5920
Address: 13550 U.S. Hwy 93 Las Vegas, NV

I hereby acknowledge receipt of the above described materials
Name (Print or Type) Signature Date Received 07 Oct 10

81 Environmental Tech
13550 N Highway 93
Las Vegas, NV 89165

Ticket Type: INBOUND INVOICE

Ticket Number: 1647
Date: 10/04/2010
Time In: 3:44 am
Time Out: 4:09 am

Customer: 001011 - NGE, LLC c/o Northgate Environ Mgmt

Vehicle/Container: 44564A
Contract: Northgate Env. On Site Soils 3825 11
Comment: 3825 10 11244

Gross Weight: 121,220 LB Manual In
Tare Weight: 48,880 LB Scale Out
Net Weight: 72340 LB
Net Tons: 36.17

BOL: 11750

Origin	Yards	Material	Billing	Quantity
Not Applicable	0.00 YD	SW CONTAMINATED SOIL	36.17	TN

Driver:

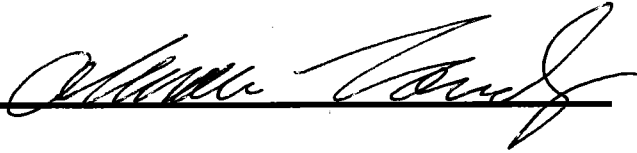

Weighmaster:

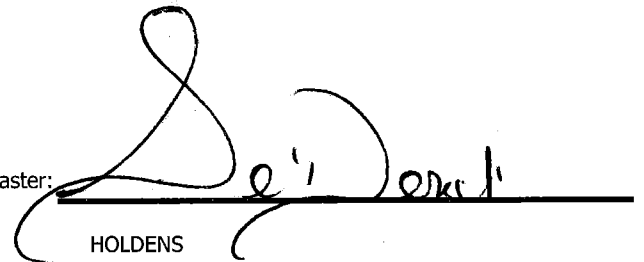

HOLDENS

Indemnification. Customer agrees, by signature above, to indemnify, hold harmless, and defend Republic Services, Inc., its subsidiaries, affiliates, employees, officers and directors from and against any and all liabilities, claims, penalties, forfeitures, suits and the costs and expenses incident thereto, including costs of defense, settlement, and reasonable attorney's fees, which may be incurred, as a result of death or injuries to any person, or damage to any property, contamination of or adverse effects on the environment, caused in whole or in part by the Customer, its employees, or subcontractors in disposing waste at this Facility. In the event Customer delivers Unacceptable Waste (as determined by Republic) Customer agrees to assume all expenses and obligations with the removal and/or resolution of any effects caused by the delivery of such Unacceptable Waste.

Indemnización. Cliente acuerda indemnizar, mantener inmune, y defender Republic Services, Inc., sus subsidiarios, compañías, divisiones, empleados, oficiales y directores contra de cualquiera y de todas responsabilidades, demandas, penas, pérdidas, juicios, pleitos y los costos incidente además, incluyendo costos de defensa, de acuerdo judicial, y de honorarios razonables del abogado, que pueden ser incurridos en, o como resultado de, la muerte o herida personal a cualquier persona, o daños a cualquier característica, propiedad, contaminación de la tierra o efectos ilícitos en esta Facilidad, causado entero o en parte por el cliente, sus empleados, o sus subcontratistas en botar basura en esta Facilidad. En el caso que el Cliente entrega, bota, basura (según lo determinado por Republic) en este Establecimiento basura inaceptable en los reglamentos de este Establecimiento, el Cliente se compromete asumir todos los costos y obligaciones con el retiro y/o la resolución de cualquier dano(s) causado por la entrega de tal basura inaceptable.



NON-HAZARDOUS WASTE MANIFEST

MANIFEST # 11750

GENERATOR INFORMATION

Generator Name: Tronox LLC
Address: P.O. Box 55
City: Henderson County: Clark
State: NV Zip: 89009
Site Location (if different): 560 W. Lake Mead
Henderson, NV 89015 (702) 592-7727

CUSTOMER/BILLING INFORMATION

Billing Name: NGE LLC c/o Northgate Environment Management
Address: 300 Frank Ogawa Plaza, Ste 510
City: Oakland County: Alameda
State: CA Zip: 94612

Table with 5 columns: Republic Services Approval #, Description of Waste, Volume/Weight, Expiration Date, Container Type. Row 1: 38251011244, Soil for disposal, 36 1/2 ton, 12-31-2011, Tractor with Dump Trailer(s).

*Attach Additional Sheet if necessary

I hereby certify that the above-described materials are non-hazardous wastes as defined by 40 CFR 261 or any applicable state law. Further, that the above named materials are properly classified, described, packaged, marked and labeled, and are in proper condition for transportation according to the applicable regulations of the Department of Transportation.

Susan Crowley (Signature)
Generator/Authorized Agent Name Signature Date Shipped

TRANSPORTER INFORMATION

Transporter Name: Las Vegas Paving DOT # 191949
Address: 4420 S. Decatur Truck Number: K003
Las Vegas, NV 89103 Phone Number: (702) 353-4355

I certify no hazardous waste or other regulated substance was knowingly introduced to the waste while in my custody. The waste transported in this vehicle is the waste identified above, to the best of my knowledge.

Asencion (Signature)
Name of Authorized Agent Signature Date Delivered 10/03/10

DISPOSAL SITE INFORMATION

Site Name: Apex Regional Landfill Phone No. (702) 599-5920
Address: 13550 U.S. Hwy 93 Las Vegas, NV

I hereby acknowledge receipt of the above described materials

Holden, Se' Derek (Signature)
Name (Print or Type) Signature Date Received 04 Oct 10

81 Environmental Tech
13550 N Highway 93
Las Vegas, NV 89165

Ticket Type: INBOUND INVOICE

Ticket Number: 1648
Date: 10/04/2010
Time In: 4:08 am
Time Out: 4:35 am

Customer: 001011 - NGE, LLC c/o Northgate Environ Mgmt

Vehicle/Container: 44164A
Contract: Northgate Env. On Site Soils 3825 11
Comment: 3825 10 11244

Gross Weight: 135,760 LB Manual In
Tare Weight: 55,500 LB Scale Out
Net Weight: 80260 LB
Net Tons: 40.13

BOL: 11751

Origin	Yards	Material	Billing	Quantity
Not Applicable	0.00 YD	SW CONTAMINATED SOIL	40.13	TN

Driver:

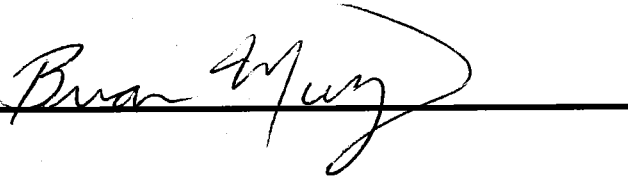

Weighmaster:

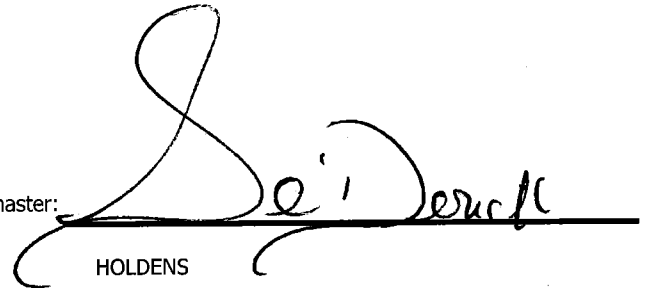

HOLDENS

Indemnification. Customer agrees, by signature above, to indemnify, hold harmless, and defend Republic Services, Inc., its subsidiaries, affiliates, employees, officers and directors from and against any and all liabilities, claims, penalties, forfeitures, suits and the costs and expenses incident thereto, including costs of defense, settlement, and reasonable attorney's fees, which may be incurred, as a result of death or injuries to any person, or damage to any property, contamination of or adverse effects on the environment, caused in whole or in part by the Customer, its employees, or subcontractors in disposing waste at this Facility. In the event Customer delivers Unacceptable Waste (as determined by Republic) Customer agrees to assume all expenses and obligations with the removal and/or resolution of any effects caused by the delivery of such Unacceptable Waste.

Indemnización. Cliente acuerda indemnizar, mantener inmune, y defender Republic Services, Inc., sus subsidiarios, compañías, divisiones, empleados, oficiales y directores contra de cualquiera y de todas responsabilidades, demandas, penas, pérdidas, juicios, pleitos y los costos incidente además, incluyendo costos de defensa, de acuerdo judicial, y de honorarios razonables del abogado, que pueden ser incurridos en, o como resultado de, la muerte o herida personal a cualquier persona, o daños a cualquier característica, propiedad, contaminación de la tierra o efectos ilícitos en esta Facilidad, causado entero o en parte por el cliente, sus empleados, o sus subcontratistas en botar basura en esta Facilidad. En el caso que el Cliente entrega, bota, basura (según lo determinado por Republic) en este Establecimiento basura inaceptable en los reglamentos de este Establecimiento, el Cliente se compromete asumir todos los costos y obligaciones con el retiro y/o la resolución de cualquier dano(s) causado por la entrega de tal basura inaceptable.



NON-HAZARDOUS WASTE MANIFEST

MANIFEST # 11751

GENERATOR INFORMATION

Generator Name: Tronox LLC
Address: P.O. Box 55
City: Henderson County: Clark
State: NV Zip: 89009
Site Location (if different): 560 W. Lake Mead
Henderson, NV 89015 (702) 592-7727

CUSTOMER/BILLING INFORMATION

Billing Name: NGE LLC c/o Northgate Environment Management
Address: 300 Frank Ogawa Plaza, Ste 510
City: Oakland County: Alameda
State: CA Zip: 94612

Table with 5 columns: Republic Services Approval #, Description of Waste, Volume/Weight, Expiration Date, Container Type. Row 1: 38251011244, Soil for disposal, 41013 ton, 12-31-2011, Tractor with Dump Trailer(s). Row 2: RZ- #

*Attach Additional Sheet if necessary

I hereby certify that the above-described materials are non-hazardous wastes as defined by 40 CFR 261 or any applicable state law. Further, that the above named materials are properly classified, described, packaged, marked and labeled, and are in proper condition for transportation according to the applicable regulations of the Department of Transportation.

Susan Crowley
Generator/Authorized Agent Name Signature Date Shipped

TRANSPORTER INFORMATION

Transporter Name: Las Vegas Paving DOT # 191949
Address: 4420 S. Decatur Truck Number: K-000
Las Vegas, NV 89103 Phone Number: (702) 353-4355

I certify no hazardous waste or other regulated substance was knowingly introduced to the waste while in my custody. The waste transported in this vehicle is the waste identified above, to the best of my knowledge.

Brian Malvey
Name of Authorized Agent Signature Date Delivered

DISPOSAL SITE INFORMATION

Site Name: Apex Regional Landfill Phone No. (702) 599-5920
Address: 13550 U.S. Hwy 93 Las Vegas, NV

I hereby acknowledge receipt of the above described materials
Name (Print or Type) Signature Date Received

81 Environmental Tech
13550 N Highway 93
Las Vegas, NV 89165

Ticket Type: INBOUND INVOICE

Ticket Number: 1649
Date: 10/04/2010
Time In: 4:15 am
Time Out: 4:38 am

Customer: 001011 - NGE, LLC c/o Northgate Environ Mgmt

Vehicle/Container: 81495P
Contract: Northgate Env. On Site Soils 3825 11
Comment: 3825 10 11244

Gross Weight: 123,280 LB Manual In
Tare Weight: 50,360 LB Manual Out
Net Weight: 72920 LB
Net Tons: 36.46

BOL: 11752

Origin	Yards	Material	Billing	Quantity
Not Applicable	0.00 YD	SW CONTAMINATED SOIL	36.46	TN

Driver: _____

Weighmaster: _____

HOLDENS

Indemnification. Customer agrees, by signature above, to indemnify, hold harmless, and defend Republic Services, Inc., its subsidiaries, affiliates, employees, officers and directors from and against any and all liabilities, claims, penalties, forfeitures, suits and the costs and expenses incident thereto, including costs of defense, settlement, and reasonable attorney's fees, which may be incurred, as a result of death or injuries to any person, or damage to any property, contamination of or adverse effects on the environment, caused in whole or in part by the Customer, its employees, or subcontractors in disposing waste at this Facility. In the event Customer delivers Unacceptable Waste (as determined by Republic) Customer agrees to assume all expenses and obligations with the removal and/or resolution of any effects caused by the delivery of such Unacceptable Waste.

Indemnización. Cliente acuerda indemnizar, mantener inmune, y defender Republic Services, Inc., sus subsidiarios, compañías, divisiones, empleados, oficiales y directores contra de cualquiera y de todas responsabilidades, demandas, penas, pérdidas, juicios, pleitos y los costos incidente además, incluyendo costos de defensa, de acuerdo judicial, y de honorarios razonables del abogado, que pueden ser incurridos en, o como resultado de, la muerte o herida personal a cualquier persona, o daños a cualquier característica, propiedad, contaminación de la tierra o efectos ilícitos en esta Facilidad, causado entero o en parte por el cliente, sus empleados, o sus subcontratistas en botar basura en esta Facilidad. En el caso que el Cliente entrega, bota, basura (según lo determinado por Republic) en este Establecimiento basura inaceptable en los reglamentos de este Establecimiento, el Cliente se compromete asumir todos los costos y obligaciones con el retiro y/o la resolución de cualquier dano(s) causado por la entrega de tal basura inaceptable.



NON-HAZARDOUS WASTE MANIFEST

MANIFEST # 11752

GENERATOR INFORMATION

Generator Name: Tronox LLC

Address: P.O. Box 55

City: Henderson County: Clark

State: NV Zip: 89009

Site Location (if different): 560 W. Lake Mead

Henderson, NV 89015 (702) 592-7727

CUSTOMER/BILLING INFORMATION

Billing Name: NGE LLC c/o Northgate Environment Management

Address: 300 Frank Ogawa Plaza, Ste 510

City: Oakland County: Alameda

State: CA Zip: 94612

Republic Services Approval #	Description of Waste	Volume/Weight	Expiration Date	Container Type
38251011244	Soil for disposal	36 ⁴⁶ / ₁₀₀ ton	12-31-2011	Tractor with Dump Trailer(s)
	RZ- _____ # _____			

*Attach Additional Sheet if necessary

I hereby certify that the above-described materials are non-hazardous wastes as defined by 40 CFR 261 or any applicable state law. Further, that the above named materials are properly classified, described, packaged, marked and labeled, and are in proper condition for transportation according to the applicable regulations of the Department of Transportation.

Susan Crowley

Susan Crowley

Generator/Authorized Agent Name

Signature

Date Shipped

TRANSPORTER INFORMATION

Transporter Name: Las Vegas Paving

DOT # 191949

Address: 4420 S. Decatur

Truck Number: 175

Las Vegas, NV 89103

Phone Number: (702) 353-4355

I certify no hazardous waste or other regulated substance was knowingly introduced to the waste while in my custody. The waste transported in this vehicle is the waste identified above, to the best of my knowledge.

Andrew Walker

[Signature]

10-4-10

Name of Authorized Agent

Signature

Date Delivered

DISPOSAL SITE INFORMATION

Site Name: Apex Regional Landfill

Phone No. (702) 599-5920

Address: 13550 U.S. Hwy 93 Las Vegas, NV

I hereby acknowledge receipt of the above described materials

Holden, Se' Derrick

Se' Derrick Holden

4 Oct 10

Name (Print or Type)

Signature

Date Received

81 Environmental Tech
13550 N Highway 93
Las Vegas, NV 89165

Ticket Type: INBOUND INVOICE

Ticket Number: 1650
Date: 10/04/2010
Time In: 4:27 am
Time Out: 4:51 am

Customer: 001011 - NGE, LLC c/o Northgate Environ Mgmt

Vehicle/Container: 81494P

Contract: Northgate Env. On Site Soils 3825 11

Comment: 3825 10 11244

Gross Weight: 121,640 LB Manual In
Tare Weight: 51,080 LB Manual Out
Net Weight: 70560 LB
Net Tons: 35.28

BOL: 11753

Origin	Yards	Material	Billing	Quantity
Not Applicable	0.00 YD	SW CONTAMINATED SOIL	35.28	TN

Driver: _____

Weighmaster: _____

HOLDENS

Indemnification. Customer agrees, by signature above, to indemnify, hold harmless, and defend Republic Services, Inc., its subsidiaries, affiliates, employees, officers and directors from and against any and all liabilities, claims, penalties, forfeitures, suits and the costs and expenses incident thereto, including costs of defense, settlement, and reasonable attorney's fees, which may be incurred, as a result of death or injuries to any person, or damage to any property, contamination of or adverse effects on the environment, caused in whole or in part by the Customer, its employees, or subcontractors in disposing waste at this Facility. In the event Customer delivers Unacceptable Waste (as determined by Republic) Customer agrees to assume all expenses and obligations with the removal and/or resolution of any effects caused by the delivery of such Unacceptable Waste.

Indemnización. Cliente acuerda indemnizar, mantener inmune, y defender Republic Services, Inc., sus subsidiarios, compañías, divisiones, empleados, oficiales y directores contra de cualquiera y de todas responsabilidades, demandas, penas, pérdidas, juicios, pleitos y los costos incidente además, incluyendo costos de defensa, de acuerdo judicial, y de honorarios razonables del abogado, que pueden ser incurridos en, o como resultado de, la muerte o herida personal a cualquier persona, o daños a cualquier característica, propiedad, contaminación de la tierra o efectos ilícitos en esta Facilidad, causado entero o en parte por el cliente, sus empleados, o sus subcontratistas en botar basura en esta Facilidad. En el caso que el Cliente entrega, bota, basura (según lo determinado por Republic) en este Establecimiento basura inaceptable en los reglamentos de este Establecimiento, el Cliente se compromete asumir todos los costos y obligaciones con el retiro y/o la resolución de cualquier dano(s) causado por la entrega de tal basura inaceptable.



NON-HAZARDOUS WASTE MANIFEST

MANIFEST # 11753

GENERATOR INFORMATION

Generator Name: Tronox LLC
Address: P.O. Box 55
City: Henderson County: Clark
State: NV Zip: 89009
Site Location (if different): 560 W. Lake Mead
Henderson, NV 89015 (702) 592-7727

CUSTOMER/BILLING INFORMATION

Billing Name: NGE LLC c/o Northgate Environment Management
Address: 300 Frank Ogawa Plaza, Ste 510
City: Oakland County: Alameda
State: CA Zip: 94612

Table with 5 columns: Republic Services Approval #, Description of Waste, Volume/Weight, Expiration Date, Container Type. Row 1: 38251011244, Soil for disposal, 35 28/100, 12-31-2011, Tractor with Dump Trailer(s).

*Attach Additional Sheet if necessary

I hereby certify that the above-described materials are non-hazardous wastes as defined by 40 CFR 261 or any applicable state law. Further, that the above named materials are properly classified, described, packaged, marked and labeled, and are in proper condition for transportation according to the applicable regulations of the Department of Transportation.

Susan Crowley (Signature)
Generator/Authorized Agent Name Signature Date Shipped

TRANSPORTER INFORMATION

Transporter Name: Las Vegas Paving DOT # 191949
Address: 4420 S. Decatur Truck Number: 125
Las Vegas, NV 89103 Phone Number: (702) 353-4355

I certify no hazardous waste or other regulated substance was knowingly introduced to the waste while in my custody. The waste transported in this vehicle is the waste identified above, to the best of my knowledge.

Calvin Pagan (Signature)
Name of Authorized Agent Signature Date Delivered 10/03/10

DISPOSAL SITE INFORMATION

Site Name: Apex Regional Landfill Phone No. (702) 599-5920
Address: 13550 U.S. Hwy 93 Las Vegas, NV

I hereby acknowledge receipt of the above described materials
Holden, Seberich (Signature)
Name (Print or Type) Signature Date Received 04 Oct 10

81 Environmental Tech
13550 N Highway 93
Las Vegas, NV 89165

Ticket Type: INBOUND INVOICE

Ticket Number: 1651
Date: 10/04/2010
Time In: 4:31 am
Time Out: 4:54 am

Customer: 001011 - NGE, LLC c/o Northgate Environ Mgmt

Vehicle/Container: 81496P
Contract: Northgate Env. On Site Soils 3825 11
Comment: 3825 10 11244

Gross Weight: 120,840 LB Manual In
Tare Weight: 50,260 LB Manual Out
Net Weight: 70580 LB
Net Tons: 35.29

BOL: 11755

Origin	Yards	Material	Billing	Quantity
Not Applicable	0.00 YD	SW CONTAMINATED SOIL	35.29	TN

Driver:

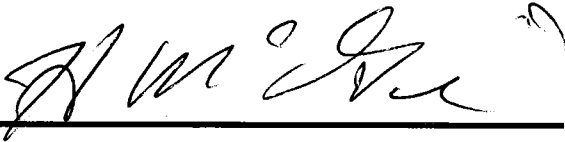

Weighmaster:

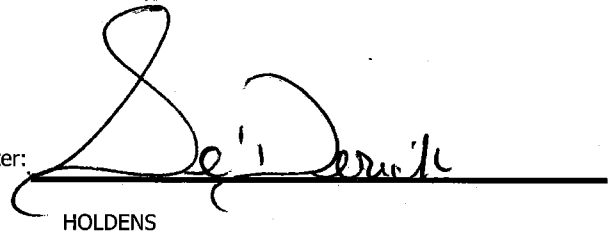

HOLDENS

Indemnification. Customer agrees, by signature above, to indemnify, hold harmless, and defend Republic Services, Inc., its subsidiaries, affiliates, employees, officers and directors from and against any and all liabilities, claims, penalties, forfeitures, suits and the costs and expenses incident thereto, including costs of defense, settlement, and reasonable attorney's fees, which may be incurred, as a result of death or injuries to any person, or damage to any property, contamination of or adverse effects on the environment, caused in whole or in part by the Customer, its employees, or subcontractors in disposing waste at this Facility. In the event Customer delivers Unacceptable Waste (as determined by Republic) Customer agrees to assume all expenses and obligations with the removal and/or resolution of any effects caused by the delivery of such Unacceptable Waste.

Indemnización. Cliente acuerda indemnizar, mantener inmune, y defender Republic Services, Inc., sus subsidiarios, compañías, divisiones, empleados, oficiales y directores contra de cualquiera y de todas responsabilidades, demandas, penas, pérdidas, juicios, pleitos y los costos incidente además, incluyendo costos de defensa, de acuerdo judicial, y de honorarios razonables del abogado, que pueden ser incurridos en, o como resultado de, la muerte o herida personal a cualquier persona, o daños a cualquier característica, propiedad, contaminación de la tierra o efectos ilícitos en esta Facilidad, causado entero o en parte por el cliente, sus empleados, o sus subcontratistas en botar basura en esta Facilidad. En el caso que el Cliente entrega, bota, basura (según lo determinado por Republic) en este Establecimiento basura inaceptable en los reglamentos de este Establecimiento, el Cliente se compromete asumir todos los costos y obligaciones con el retiro y/o la resolución de cualquier dano(s) causado por la entrega de tal basura inaceptable.



NON-HAZARDOUS WASTE MANIFEST

MANIFEST # 11755

GENERATOR INFORMATION

Generator Name: Tronox LLC

Address: P.O. Box 55

City: Henderson County: Clark

State: NV Zip: 89009

Site Location (if different): 560 W. Lake Mead

Henderson, NV 89015 (702) 592-7727

CUSTOMER/BILLING INFORMATION

Billing Name: NGE LLC c/o Northgate Environment Management

Address: 300 Frank Ogawa Plaza, Ste 510

City: Oakland County: Alameda

State: CA Zip: 94612

Table with 5 columns: Republic Services Approval #, Description of Waste, Volume/Weight, Expiration Date, Container Type. Row 1: 38251011244, Soil for disposal, 35 29/10n, 12-31-2011, Tractor with Dump Trailer(s).

*Attach Additional Sheet if necessary

I hereby certify that the above-described materials are non-hazardous wastes as defined by 40 CFR 261 or any applicable state law. Further, that the above named materials are properly classified, described, packaged, marked and labeled, and are in proper condition for transportation according to the applicable regulations of the Department of Transportation.

Susan Crowley Generator/Authorized Agent Name Signature Date Shipped

TRANSPORTER INFORMATION

Transporter Name: Las Vegas Paving DOT # 191949

Address: 4420 S. Decatur Truck Number: 145

Las Vegas, NV 89103 Phone Number: (702) 353-4355

I certify no hazardous waste or other regulated substance was knowingly introduced to the waste while in my custody. The waste transported in this vehicle is the waste identified above, to the best of my knowledge.

Harry M'Gral Name of Authorized Agent Signature Date Delivered 10-3-10

DISPOSAL SITE INFORMATION

Site Name: Apex Regional Landfill Phone No. (702) 599-5920

Address: 13550 U.S. Hwy 93 Las Vegas, NV

I hereby acknowledge receipt of the above described materials Holden, Se'Derrick Name (Print or Type) Signature Date Received 01 Oct 10

81 Environmental Tech
13550 N Highway 93
Las Vegas, NV 89165

Ticket Type: INBOUND INVOICE

Ticket Number: 1652
Date: 10/04/2010
Time In: 4:30 am
Time Out: 4:54 am

Customer: 001011 - NGE, LLC c/o Northgate Environ Mgmt

Vehicle/Container: 20915A
Contract: Northgate Env. On Site Soils 3825 11
Comment: 3825 10 11244

Gross Weight: 123,820 LB Manual In
Tare Weight: 53,000 LB Scale Out
Net Weight: 70820 LB
Net Tons: 35.41

BOL: 11754

Origin	Yards	Material	Billing	Quantity
Not Applicable	0.00 YD	SW CONTAMINATED SOIL	35.41	TN

Driver:

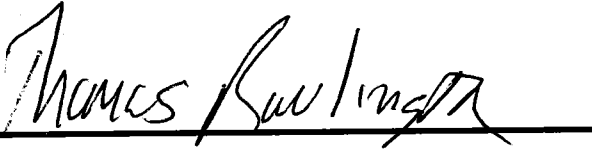

Weighmaster:

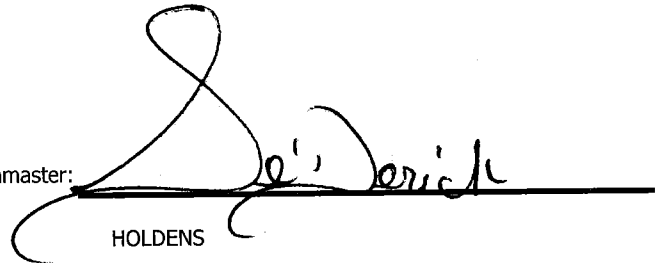

HOLDENS

Indemnification. Customer agrees, by signature above, to indemnify, hold harmless, and defend Republic Services, Inc., its subsidiaries, affiliates, employees, officers and directors from and against any and all liabilities, claims, penalties, forfeitures, suits and the costs and expenses incident thereto, including costs of defense, settlement, and reasonable attorney's fees, which may be incurred, as a result of death or injuries to any person, or damage to any property, contamination of or adverse effects on the environment, caused in whole or in part by the Customer, its employees, or subcontractors in disposing waste at this Facility. In the event Customer delivers Unacceptable Waste (as determined by Republic) Customer agrees to assume all expenses and obligations with the removal and/or resolution of any effects caused by the delivery of such Unacceptable Waste.

Indemnización. Cliente acuerda indemnizar, mantener inmune, y defender Republic Services, Inc., sus subsidiarios, compañías, divisiones, empleados, oficiales y directores contra de cualquiera y de todas responsabilidades, demandas, penas, pérdidas, juicios, pleitos y los costos incidente además, incluyendo costos de defensa, de acuerdo judicial, y de honorarios razonables del abogado, que pueden ser incurridos en, o como resultado de, la muerte o herida personal a cualquier persona, o daños a cualquier característica, propiedad, contaminación de la tierra o efectos ilícitos en esta Facilidad, causado entero o en parte por el cliente, sus empleados, o sus subcontratistas en botar basura en esta Facilidad. En el caso que el Cliente entrega, bota, basura (según lo determinado por Republic) en este Establecimiento basura inaceptable en los reglamentos de este Establecimiento, el Cliente se compromete asumir todos los costos y obligaciones con el retiro y/o la resolución de cualquier dano(s) causado por la entrega de tal basura inaceptable.



NON-HAZARDOUS WASTE MANIFEST

MANIFEST # 11754

GENERATOR INFORMATION

Generator Name: Tronox LLC
Address: P.O. Box 55
City: Henderson County: Clark
State: NV Zip: 89009
Site Location (if different): 560 W. Lake Mead
Henderson, NV 89015 (702) 592-7727

CUSTOMER/BILLING INFORMATION

Billing Name: NGE LLC c/o Northgate Environment Management
Address: 300 Frank Ogawa Plaza, Ste 510
City: Oakland County: Alameda
State: CA Zip: 94612

Table with 5 columns: Republic Services Approval #, Description of Waste, Volume/Weight, Expiration Date, Container Type. Row 1: 38251011244, Soil for disposal, 35 9/10 ton, 12-31-2011, Tractor with Dump Trailer(s). Row 2: RZ- #

*Attach Additional Sheet if necessary

I hereby certify that the above-described materials are non-hazardous wastes as defined by 40 CFR 261 or any applicable state law. Further, that the above named materials are properly classified, described, packaged, marked and labeled, and are in proper condition for transportation according to the applicable regulations of the Department of Transportation.

Susan Crowley
Generator/Authorized Agent Name Signature Date Shipped

TRANSPORTER INFORMATION

Transporter Name: Las Vegas Paving DOT # 191949
Address: 4420 S. Decatur Truck Number: 00
Las Vegas, NV 89103 Phone Number: (702) 353-4355

I certify no hazardous waste or other regulated substance was knowingly introduced to the waste while in my custody. The waste transported in this vehicle is the waste identified above, to the best of my knowledge.

Tom Rawlins Jr
Name of Authorized Agent Signature Date Delivered 10-4-10

DISPOSAL SITE INFORMATION

Site Name: Apex Regional Landfill Phone No: (702) 599-5920
Address: 13550 U.S. Hwy 93 Las Vegas, NV

I hereby acknowledge receipt of the above described materials
Holden Sebeck
Name (Print or Type) Signature Date Received 04 Oct 10

81 Environmental Tech
13550 N Highway 93
Las Vegas, NV 89165

Ticket Type: INBOUND INVOICE

Ticket Number: 1653
Date: 10/04/2010
Time In: 6:28 am
Time Out: 6:55 am

Customer: 001011 - NGE, LLC c/o Northgate Environ Mgmt

Vehicle/Container: 43078A

Contract: Northgate Env. On Site Soils 3825 11
Comment: 3825-10-11244

Gross Weight: 128,480 LB Manual In
Tare Weight: 52,140 LB Scale Out
Net Weight: 76340 LB
Net Tons: 38.17

BOL: 11748

Origin	Yards	Material	Billing	Quantity
Not Applicable	0.00 YD	SW CONTAMINATED SOIL	38.17	TN

Driver: 

Weighmaster: 05

JORDADE

Indemnification. Customer agrees, by signature above, to indemnify, hold harmless, and defend Republic Services, Inc., its subsidiaries, affiliates, employees, officers and directors from and against any and all liabilities, claims, penalties, forfeitures, suits and the costs and expenses incident thereto, including costs of defense, settlement, and reasonable attorney's fees, which may be incurred, as a result of death or injuries to any person, or damage to any property, contamination of or adverse effects on the environment, caused in whole or in part by the Customer, its employees, or subcontractors in disposing waste at this Facility. In the event Customer delivers Unacceptable Waste (as determined by Republic) Customer agrees to assume all expenses and obligations with the removal and/or resolution of any effects caused by the delivery of such Unacceptable Waste.

Indemnización. Cliente acuerda indemnizar, mantener inmune, y defender Republic Services, Inc., sus subsidiarios, compañías, divisiones, empleados, oficiales y directores contra de cualquiera y de todas responsabilidades, demandas, penas, pérdidas, juicios, pleitos y los costos incidente además, incluyendo costos de defensa, de acuerdo judicial, y de honorarios razonables del abogado, que pueden ser incurridos en, o como resultado de, la muerte o herida personal a cualquier persona, o daños a cualquier característica, propiedad, contaminación de la tierra o efectos ilícitos en esta Facilidad, causado entero o en parte por el cliente, sus empleados, o sus subcontratistas en botar basura en esta Facilidad. En el caso que el Cliente entrega, bota, basura (según lo determinado por Republic) en este Establecimiento basura inaceptable en los reglamentos de este Establecimiento, el Cliente se compromete asumir todos los costos y obligaciones con el retiro y/o la resolución de cualquier dano(s) causado por la entrega de tal basura inaceptable.



NON-HAZARDOUS WASTE MANIFEST

MANIFEST # 11748

GENERATOR INFORMATION

Generator Name: Tronox LLC
Address: P.O. Box 55
City: Henderson County: Clark
State: NV Zip: 89009
Site Location (if different): 560 W. Lake Mead
Henderson, NV 89015 (702) 592-7727

CUSTOMER/BILLING INFORMATION

Billing Name: NGE LLC c/o Northgate Environment Management
Address: 300 Frank Ogawa Plaza, Ste 510
City: Oakland County: Alameda
State: CA Zip: 94612

Table with 5 columns: Republic Services Approval #, Description of Waste, Volume/Weight, Expiration Date, Container Type. Row 1: 38251011244, Soil for disposal, 38.17, 12-31-2011, Tractor with Dump Trailer(s).

*Attach Additional Sheet if necessary

I hereby certify that the above-described materials are non-hazardous wastes as defined by 40 CFR 261 or any applicable state law. Further, that the above named materials are properly classified, described, packaged, marked and labeled, and are in proper condition for transportation according to the applicable regulations of the Department of Transportation.

Susan Crowley (Signature)
Generator/Authorized Agent Name Signature Date Shipped

TRANSPORTER INFORMATION

Transporter Name: Las Vegas Paving DOT # 191949
Address: 4420 S. Decatur Truck Number: DWF 200
Las Vegas, NV 89103 Phone Number: (702) 353-4355

I certify no hazardous waste or other regulated substance was knowingly introduced to the waste while in my custody. The waste transported in this vehicle is the waste identified above, to the best of my knowledge.

Dean Fechner (Signature)
Name of Authorized Agent Signature Date Delivered 10-4-10

DISPOSAL SITE INFORMATION

Site Name: Apex Regional Landfill Phone No. (702) 599-5920
Address: 13550 U.S. Hwy 93 Las Vegas, NV

I hereby acknowledge receipt of the above described materials
Debra Jordan (Signature)
Name (Print or Type) Signature Date Received 10-4-10

81 Environmental Tech
13550 N Highway 93
Las Vegas, NV 89165

Ticket Type: INBOUND INVOICE

Ticket Number: 1654
Date: 10/04/2010
Time In: 7:40 am
Time Out: 8:03 am

Customer: 001011 - NGE, LLC c/o Northgate Environ Mgmt

Vehicle/Container: 192391
Contract: Northgate Env. On Site Soils 3825 11
Comment: 3825-1011244

Gross Weight: 80,760 LB Scale In
Tare Weight: 39,080 LB Scale Out
Net Weight: 41680 LB
Net Tons: 20.84

BOL: 11756

Origin	Yards	Material	Billing	Quantity
Not Applicable	0.00 YD	SW CONTAMINATED SOIL	20.84	TN

Driver: _____

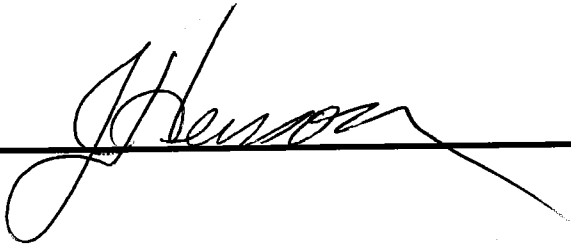

Weighmaster: _____

05

JORDADE

Indemnification. Customer agrees, by signature above, to indemnify, hold harmless, and defend Republic Services, Inc., its subsidiaries, affiliates, employees, officers and directors from and against any and all liabilities, claims, penalties, forfeitures, suits and the costs and expenses incident thereto, including costs of defense, settlement, and reasonable attorney's fees, which may be incurred, as a result of death or injuries to any person, or damage to any property, contamination of or adverse effects on the environment, caused in whole or in part by the Customer, its employees, or subcontractors in disposing waste at this Facility. In the event Customer delivers Unacceptable Waste (as determined by Republic) Customer agrees to assume all expenses and obligations with the removal and/or resolution of any effects caused by the delivery of such Unacceptable Waste.

Indemnización. Cliente acuerda indemnizar, mantener inmune, y defender Republic Services, Inc., sus subsidiarios, compañías, divisiones, empleados, oficiales y directores contra de cualquiera y de todas responsabilidades, demandas, penas, pérdidas, juicios, pleitos y los costos incidente además, incluyendo costos de defensa, de acuerdo judicial, y de honorarios razonables del abogado, que pueden ser incurridos en, o como resultado de, la muerte o herida personal a cualquier persona, o daños a cualquier característica, propiedad, contaminación de la tierra o efectos ilícitos en esta Facilidad, causado entero o en parte por el cliente, sus empleados, o sus subcontratistas en botar basura en esta Facilidad. En el caso que el Cliente entrega, bota, basura (según lo determinado por Republic) en este Establecimiento basura inaceptable en los reglamentos de este Establecimiento, el Cliente se compromete asumir todos los costos y obligaciones con el retiro y/o la resolución de cualquier dano(s) causado por la entrega de tal basura inaceptable.



NON-HAZARDOUS WASTE MANIFEST

MANIFEST # 11756

GENERATOR INFORMATION

Generator Name: Tronox LLC
Address: P.O. Box 55
City: Henderson County: Clark
State: NV Zip: 89009
Site Location (if different): 560 W. Lake Mead
Henderson, NV 89015 (702) 592-7727

CUSTOMER/BILLING INFORMATION

Billing Name: NGE LLC c/o Northgate Environment Management
Address: 300 Frank Ogawa Plaza, Ste 510
City: Oakland County: Alameda
State: CA Zip: 94612

Table with 5 columns: Republic Services Approval #, Description of Waste, Volume/Weight, Expiration Date, Container Type. Row 1: 38251011244, Soil for disposal, 2084 TN, 12-31-2011, Tractor with Dump Trailer(s). Row 2: RZ-D # 29

*Attach Additional Sheet if necessary

I hereby certify that the above-described materials are non-hazardous wastes as defined by 40 CFR 261 or any applicable state law. Further, that the above named materials are properly classified, described, packaged, marked and labeled, and are in proper condition for transportation according to the applicable regulations of the Department of Transportation.

Susan Crowley
Generator/Authorized Agent Name Signature Date Shipped

TRANSPORTER INFORMATION

Transporter Name: Las Vegas Paving DOT # 191949
Address: 4420 S. Decatur Truck Number: 192391
Las Vegas, NV 89103 Phone Number: (702) 353-4355

I certify no hazardous waste or other regulated substance was knowingly introduced to the waste while in my custody. The waste transported in this vehicle is the waste identified above, to the best of my knowledge.

Name of Authorized Agent Signature Date Delivered 10-4-10

DISPOSAL SITE INFORMATION

Site Name: Apex Regional Landfill Phone No. (702) 599-5920
Address: 13550 U.S. Hwy 93 Las Vegas, NV

I hereby acknowledge receipt of the above described materials
Name (Print or Type) Signature Date Received 10-4-10

81 Environmental Tech
13550 N Highway 93
Las Vegas, NV 89165

Ticket Type: INBOUND INVOICE

Ticket Number: 1656
Date: 10/04/2010
Time In: 7:15 am
Time Out: 8:53 am

Customer: 001011 - NGE, LLC c/o Northgate Environ Mgmt

Vehicle/Container: 192346
Contract: Northgate Env Asbestos Soils 3825 1
Comment: 3825*10-11244

Gross Weight: 87,760 LB Scale In
Tare Weight: 36,980 LB Scale Out
Net Weight: 50780 LB
Net Tons: 25.39

BOL: 11757

Origin	Yards	Material	Billing Quantity
Not Applicable	0.00 YD	<i>Sw Cont soil</i> ASBESTOS NONFRIABLE	25.39 TN

Driver: _____



Weighmaster: _____



IN - JORDADE OUT - walkera

Indemnification. Customer agrees, by signature above, to indemnify, hold harmless, and defend Republic Services, Inc., its subsidiaries, affiliates, employees, officers and directors from and against any and all liabilities, claims, penalties, forfeitures, suits and the costs and expenses incident thereto, including costs of defense, settlement, and reasonable attorney's fees, which may be incurred, as a result of death or injuries to any person, or damage to any property, contamination of or adverse effects on the environment, caused in whole or in part by the Customer, its employees, or subcontractors in disposing waste at this Facility. In the event Customer delivers Unacceptable Waste (as determined by Republic) Customer agrees to assume all expenses and obligations with the removal and/or resolution of any effects caused by the delivery of such Unacceptable Waste.

Indemnización. Cliente acuerda indemnizar, mantener inmune, y defender Republic Services, Inc., sus subsidiarios, compañías, divisiones, empleados, oficiales y directores contra de cualquiera y de todas responsabilidades, demandas, penas, pérdidas, juicios, pleitos y los costos incidente además, incluyendo costos de defensa, de acuerdo judicial, y de honorarios razonables del abogado, que pueden ser incurridos en, o como resultado de, la muerte o herida personal a cualquier persona, o daños a cualquier característica, propiedad, contaminación de la tierra o efectos ilícitos en esta Facilidad, causado entero o en parte por el cliente, sus empleados, o sus subcontratistas en botar basura en esta Facilidad. En el caso que el Cliente entrega, bota, basura (según lo determinado por Republic) en este Establecimiento basura inaceptable en los reglamentos de este Establecimiento, el Cliente se compromete asumir todos los costos y obligaciones con el retiro y/o la resolución de cualquier dano(s) causado por la entrega de tal basura inaceptable.



NON-HAZARDOUS WASTE MANIFEST

MANIFEST # 11757

GENERATOR INFORMATION

Generator Name: Tronox LLC
Address: P.O. Box 55
City: Henderson County: Clark
State: NV Zip: 89009

CUSTOMER/BILLING INFORMATION

Billing Name: NGE LLC c/o Northgate Environment Management
Address: 300 Frank Ogawa Plaza, Ste 510
City: Oakland County: Alameda
State: CA Zip: 94612

Site Location (if different): 560 W. Lake Mead
Henderson, NV 89015 (702) 592-7727

Table with 5 columns: Republic Services Approval #, Description of Waste, Volume/Weight, Expiration Date, Container Type. Row 1: 38251011244, Soil for disposal, 25.39 TN, 12-31-2011, Tractor with Dump Trailer(s). Row 2: RZ-D # 29, 25.39 TN, 0539.

*Attach Additional Sheet if necessary

I hereby certify that the above-described materials are non-hazardous wastes as defined by 40 CFR 261 or any applicable state law. Further, that the above named materials are properly classified, described, packaged, marked and labeled, and are in proper condition for transportation according to the applicable regulations of the Department of Transportation.

Susan Crowley
Generator/Authorized Agent Name Signature Date Shipped

TRANSPORTER INFORMATION

Transporter Name: Las Vegas Paving DOT # 191949
Address: 4420 S. Decatur Truck Number:
Las Vegas, NV 89103 Phone Number: (702) 353-4355

I certify no hazardous waste or other regulated substance was knowingly introduced to the waste while in my custody. The waste transported in this vehicle is the waste identified above, to the best of my knowledge.

Name of Authorized Agent Signature Date Delivered 10-4-10

DISPOSAL SITE INFORMATION

Site Name: Apex Regional Landfill Phone No. (702) 599-5920
Address: 13550 U.S. Hwy 93 Las Vegas, NV

I hereby acknowledge receipt of the above described materials
Name (Print or Type) Signature Date Received 10/4/10

81 Environmental Tech
13550 N Highway 93
Las Vegas, NV 89165

Ticket Type: INBOUND INVOICE

Ticket Number: 1657
Date: 10/04/2010
Time In: 9:44 am
Time Out: 10:06 am

Customer: 001011 - NGE, LLC c/o Northgate Environ Mgmt

Vehicle/Container: 192391

Contract: Northgate Env. On Site Soils 3825 1t

Gross Weight: 84,680 LB Scale In
Tare Weight: 38,920 LB Scale Out
Net Weight: 45760 LB
Net Tons: 22.88

BOL: 11758

Origin	Yards	Material	Billing	Quantity
Not Applicable	0.00 YD	SW CONTAMINATED SOIL	22.88	TN

Driver: _____

Weighmaster: _____

IN - WALKERA OUT - GUILFDE

Indemnification. Customer agrees, by signature above, to indemnify, hold harmless, and defend Republic Services, Inc., its subsidiaries, affiliates, employees, officers and directors from and against any and all liabilities, claims, penalties, forfeitures, suits and the costs and expenses incident thereto, including costs of defense, settlement, and reasonable attorney's fees, which may be incurred, as a result of death or injuries to any person, or damage to any property, contamination of or adverse effects on the environment, caused in whole or in part by the Customer, its employees, or subcontractors in disposing waste at this Facility. In the event Customer delivers Unacceptable Waste (as determined by Republic) Customer agrees to assume all expenses and obligations with the removal and/or resolution of any effects caused by the delivery of such Unacceptable Waste.

Indemnización. Cliente acuerda indemnizar, mantener inmune, y defender Republic Services, Inc., sus subsidiarios, compañías, divisiones, empleados, oficiales y directores contra de cualquiera y de todas responsabilidades, demandas, penas, pérdidas, juicios, pleitos y los costos incidente además, incluyendo costos de defensa, de acuerdo judicial, y de honorarios razonables del abogado, que pueden ser incurridos en, o como resultado de, la muerte o herida personal a cualquier persona, o daños a cualquier característica, propiedad, contaminación de la tierra o efectos ilícitos en esta Facilidad, causado entero o en parte por el cliente, sus empleados, o sus subcontratistas en botar basura en esta Facilidad. En el caso que el Cliente entrega, bota, basura (según lo determinado por Republic) en este Establecimiento basura inaceptable en los reglamentos de este Establecimiento, el Cliente se compromete asumir todos los costos y obligaciones con el retiro y/o la resolución de cualquier dano(s) causado por la entrega de tal basura inaceptable.



NON-HAZARDOUS WASTE MANIFEST

MANIFEST # 11758

GENERATOR INFORMATION

Generator Name: Tronox LLC

Address: P.O. Box 55

City: Henderson County: Clark

State: NV Zip: 89009

Site Location (if different): 560 W. Lake Mead

Henderson, NV 89015 (702) 592-7727

CUSTOMER/BILLING INFORMATION

Billing Name: NGE LLC c/o Northgate Environment Management

Address: 300 Frank Ogawa Plaza, Ste 510

City: Oakland County: Alameda

State: CA Zip: 94612

Republic Services Approval #	Description of Waste	Volume/Weight	Expiration Date	Container Type
38251011244	Soil for disposal		12-31-2011	Tractor with Dump Trailer(s)
	RZ- _____ # _____	22.88T		

*Attach Additional Sheet if necessary

I hereby certify that the above-described materials are non-hazardous wastes as defined by 40 CFR 261 or any applicable state law. Further, that the above named materials are properly classified, described, packaged, marked and labeled, and are in proper condition for transportation according to the applicable regulations of the Department of Transportation.

Susan Crowley
Generator/Authorized Agent Name
Signature
Date Shipped

TRANSPORTER INFORMATION

Transporter Name: Las Vegas Paving

DOT # 191949

Address: 4420 S. Decatur

Truck Number: 192391

Las Vegas, NV 89103

Phone Number: (702) 353-4355

I certify no hazardous waste or other regulated substance was knowingly introduced to the waste while in my custody. The waste transported in this vehicle is the waste identified above, to the best of my knowledge.

Name of Authorized Agent
Signature
Date Delivered

DISPOSAL SITE INFORMATION

Site Name: Apex Regional Landfill

Phone No. (702) 599-5920

Address: 13550 U.S. Hwy 93 Las Vegas, NV

I hereby acknowledge receipt of the above described materials
Name (Print or Type)
Signature
Date Received

81 Environmental Tech
13550 N Highway 93
Las Vegas, NV 89165

Ticket Type: INBOUND INVOICE

Ticket Number: 1660
Date: 10/04/2010
Time In: 11:52 am
Time Out: 12:16 pm

Customer: 001011 - NGE, LLC c/o Northgate Environ Mgmt

Vehicle/Container: 192391
Contract: Northgate Env. On Site Soils 3825 11
Comment: 192391

Gross Weight: 94,200 LB Scale In
Tare Weight: 39,200 LB Scale Out
Net Weight: 55000 LB
Net Tons: 27.50

BOL: 11760

Origin	Yards	Material	Billing	Quantity
Not Applicable	0.00 YD	SW CONTAMINATED SOIL	27.50	TN

Driver: _____

Weighmaster: _____

IN - GUILFDE OUT - WALKERA

Indemnification. Customer agrees, by signature above, to indemnify, hold harmless, and defend Republic Services, Inc., its subsidiaries, affiliates, employees, officers and directors from and against any and all liabilities, claims, penalties, forfeitures, suits and the costs and expenses incident thereto, including costs of defense, settlement, and reasonable attorney's fees, which may be incurred, as a result of death or injuries to any person, or damage to any property, contamination of or adverse effects on the environment, caused in whole or in part by the Customer, its employees, or subcontractors in disposing waste at this Facility. In the event Customer delivers Unacceptable Waste (as determined by Republic) Customer agrees to assume all expenses and obligations with the removal and/or resolution of any effects caused by the delivery of such Unacceptable Waste.

Indemnización. Cliente acuerda indemnizar, mantener inmune, y defender Republic Services, Inc., sus subsidiarios, compañías, divisiones, empleados, oficiales y directores contra de cualquiera y de todas responsabilidades, demandas, penas, pérdidas, juicios, pleitos y los costos incidente además, incluyendo costos de defensa, de acuerdo judicial, y de honorarios razonables del abogado, que pueden ser incurridos en, o como resultado de, la muerte o herida personal a cualquier persona, o daños a cualquier característica, propiedad, contaminación de la tierra o efectos ilícitos en esta Facilidad, causado entero o en parte por el cliente, sus empleados, o sus subcontratistas en botar basura en esta Facilidad. En el caso que el Cliente entrega, bota, basura (según lo determinado por Republic) en este Establecimiento basura inaceptable en los reglamentos de este Establecimiento, el Cliente se compromete asumir todos los costos y obligaciones con el retiro y/o la resolución de cualquier dano(s) causado por la entrega de tal basura inaceptable.



NON-HAZARDOUS WASTE MANIFEST

MANIFEST # 11760

GENERATOR INFORMATION

Generator Name: Tronox LLC
Address: P.O. Box 55
City: Henderson County: Clark
State: NV Zip: 89009
Site Location (if different): 560 W. Lake Mead
Henderson, NV 89015 (702) 592-7727

CUSTOMER/BILLING INFORMATION

Billing Name: NGE LLC c/o Northgate Environment Management
Address: 300 Frank Ogawa Plaza, Ste 510
City: Oakland County: Alameda
State: CA Zip: 94612

Republic Services Approval #	Description of Waste	Volume/Weight	Expiration Date	Container Type
38251011244	Soil for disposal		12-31-2011	Tractor with Dump Trailer(s)
	RZ- <u>D</u> # <u>29</u>	<u>27.50 TN</u>	07-30	

*Attach Additional Sheet if necessary

I hereby certify that the above-described materials are non-hazardous wastes as defined by 40 CFR 261 or any applicable state law. Further, that the above named materials are properly classified, described, packaged, marked and labeled, and are in proper condition for transportation according to the applicable regulations of the Department of Transportation.

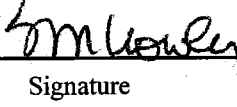
Susan Crowley 
Generator/Authorized Agent Name Signature Date Shipped

TRANSPORTER INFORMATION

Transporter Name: Las Vegas Paving DOT # 191949
Address: 4420 S. Decatur Truck Number: 192391
Las Vegas, NV 89103 Phone Number: (702) 353-4355

I certify no hazardous waste or other regulated substance was knowingly introduced to the waste while in my custody. The waste transported in this vehicle is the waste identified above, to the best of my knowledge.

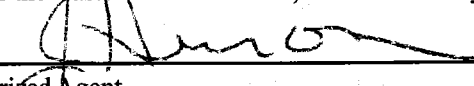
 10-4-10
Name of Authorized Agent Signature Date Delivered

DISPOSAL SITE INFORMATION

Site Name: Apex Regional Landfill Phone No. (702) 599-5920
Address: 13550 U.S. Hwy 93 Las Vegas, NV

I hereby acknowledge receipt of the above described materials
Orinial Drake Walker Orinial D.W. 10/4/10
Name (Print or Type) Signature Date Received

81 Environmental Tech
13550 N Highway 93
Las Vegas, NV 89165

Ticket Type: INBOUND INVOICE

Ticket Number: 1661
Date: 10/04/2010
Time In: 11:53 am
Time Out: 12:19 pm

Customer: 001011 - NGE, LLC c/o Northgate Environ Mgmt

Vehicle/Container: 192346

Contract: Northgate Env Asbestos Soils 3825 1

Comment: ~~346~~ 382510 11244

11759

Gross Weight: 84,680 LB Scale In
Tare Weight: 36,960 LB Manual Out
Net Weight: 47720 LB
Net Tons: 23.86

Origin	Yards	Material	Billing Quantity
Not Applicable	0.00 YD	SW Cont soil ASBESTOS NONERTABLE	23.86 TN

Driver: 

Weighmaster: 

IN - GUILFDE OUT - JORDADE

Indemnification. Customer agrees, by signature above, to indemnify, hold harmless, and defend Republic Services, Inc., its subsidiaries, affiliates, employees, officers and directors from and against any and all liabilities, claims, penalties, forfeitures, suits and the costs and expenses incident thereto, including costs of defense, settlement, and reasonable attorney's fees, which may be incurred, as a result of death or injuries to any person, or damage to any property, contamination of or adverse effects on the environment, caused in whole or in part by the Customer, its employees, or subcontractors in disposing waste at this Facility. In the event Customer delivers Unacceptable Waste (as determined by Republic) Customer agrees to assume all expenses and obligations with the removal and/or resolution of any effects caused by the delivery of such Unacceptable Waste.

Indemnización. Cliente acuerda indemnizar, mantener inmune, y defender Republic Services, Inc., sus subsidiarios, compañías, divisiones, empleados, oficiales y directores contra de cualquiera y de todas responsabilidades, demandas, penas, pérdidas, juicios, pleitos y los costos incidente además, incluyendo costos de defensa, de acuerdo judicial, y de honorarios razonables del abogado, que pueden ser incurridos en, o como resultado de, la muerte o herida personal a cualquier persona, o daños a cualquier característica, propiedad, contaminación de la tierra o efectos ilícitos en esta Facilidad, causado entero o en parte por el cliente, sus empleados, o sus subcontratistas en botar basura en esta Facilidad. En el caso que el Cliente entrega, bota, basura (según lo determinado por Republic) en este Establecimiento basura inaceptable en los reglamentos de este Establecimiento, el Cliente se compromete asumir todos los costos y obligaciones con el retiro y/o la resolución de cualquier dano(s) causado por la entrega de tal basura inaceptable.



NON-HAZARDOUS WASTE MANIFEST

MANIFEST # 11759

GENERATOR INFORMATION

Generator Name: Tronox LLC
Address: P.O. Box 55
City: Henderson County: Clark
State: NV Zip: 89009

CUSTOMER/BILLING INFORMATION

Billing Name: NGE LLC c/o Northgate Environment Management
Address: 300 Frank Ogawa Plaza, Ste 510
City: Oakland County: Alameda
State: CA Zip: 94612

Site Location (if different): 560 W. Lake Mead
Henderson, NV 89015 (702) 592-7727

Table with 5 columns: Republic Services Approval #, Description of Waste, Volume/Weight, Expiration Date, Container Type. Row 1: 38251011244, Soil for disposal, 23.86 + N, 12-31-2011, Tractor with Dump Trailer(s).

*Attach Additional Sheet if necessary

I hereby certify that the above-described materials are non-hazardous wastes as defined by 40 CFR 261 or any applicable state law. Further, that the above named materials are properly classified, described, packaged, marked and labeled, and are in proper condition for transportation according to the applicable regulations of the Department of Transportation.

Susan Crowley (Signature)
Generator/Authorized Agent Name Signature Date Shipped

TRANSPORTER INFORMATION

Transporter Name: Las Vegas Paving DOT # 191949
Address: 4420 S. Decatur Truck Number: 192346
Las Vegas, NV 89103 Phone Number: (702) 353-4355

I certify no hazardous waste or other regulated substance was knowingly introduced to the waste while in my custody. The waste transported in this vehicle is the waste identified above, to the best of my knowledge.

(Signature) 10-04-10
Name of Authorized Agent Signature Date Delivered

DISPOSAL SITE INFORMATION

Site Name: Apex Regional Landfill Phone No. (702) 599-5920
Address: 13550 U.S. Hwy 93 Las Vegas, NV

I hereby acknowledge receipt of the above described materials
Beide Jordan (Signature) 10-4-10
Name (Print or Type) Signature Date Received

81 Environmental Tech
13550 N Highway 93
Las Vegas, NV 89165

Ticket Type: INBOUND INVOICE

Ticket Number: 1663
Date: 10/04/2010
Time In: 7:56 pm
Time Out: 8:19 pm

Customer: 001011 - NGE, LLC c/o Northgate Environ Mgmt

Vehicle/Container: 81494P
Contract: Northgate Env. On Site Soils 3825 11
Comment: 3825 10 11244

Gross Weight: 117,360 LB Manual In
Tare Weight: 51,020 LB Manual Out
Net Weight: 66340 LB
Net Tons: 33.17

BOL: 11761

Origin	Yards	Material	Billing	Quantity
Not Applicable	0.00 YD	SW CONTAMINATED SOIL	33.17	TN

Driver: _____



Weighmaster: _____

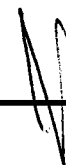

CARTERJ

Indemnification. Customer agrees, by signature above, to indemnify, hold harmless, and defend Republic Services, Inc., its subsidiaries, affiliates, employees, officers and directors from and against any and all liabilities, claims, penalties, forfeitures, suits and the costs and expenses incident thereto, including costs of defense, settlement, and reasonable attorney's fees, which may be incurred, as a result of death or injuries to any person, or damage to any property, contamination of or adverse effects on the environment, caused in whole or in part by the Customer, its employees, or subcontractors in disposing waste at this Facility. In the event Customer delivers Unacceptable Waste (as determined by Republic) Customer agrees to assume all expenses and obligations with the removal and/or resolution of any effects caused by the delivery of such Unacceptable Waste.

Indemnización. Cliente acuerda indemnizar, mantener inmune, y defender Republic Services, Inc., sus subsidiarios, compañías, divisiones, empleados, oficiales y directores contra de cualquiera y de todas responsabilidades, demandas, penas, pérdidas, juicios, pleitos y los costos incidente además, incluyendo costos de defensa, de acuerdo judicial, y de honorarios razonables del abogado, que pueden ser incurridos en, o como resultado de, la muerte o herida personal a cualquier persona, o daños a cualquier característica, propiedad, contaminación de la tierra o efectos ilícitos en esta Facilidad, causado entero o en parte por el cliente, sus empleados, o sus subcontratistas en botar basura en esta Facilidad. En el caso que el Cliente entrega, bota, basura (según lo determinado por Republic) en este Establecimiento basura inaceptable en los reglamentos de este Establecimiento, el Cliente se compromete asumir todos los costos y obligaciones con el retiro y/o la resolución de cualquier dano(s) causado por la entrega de tal basura inaceptable.



NON-HAZARDOUS WASTE MANIFEST

MANIFEST # 11761

GENERATOR INFORMATION

Generator Name: Tronox LLC
Address: P.O. Box 55
City: Henderson County: Clark
State: NV Zip: 89009
Site Location (if different): 560 W. Lake Mead
Henderson, NV 89015 (702) 592-7727

CUSTOMER/BILLING INFORMATION

Billing Name: NGE LLC c/o Northgate Environment Management
Address: 300 Frank Ogawa Plaza, Ste 510
City: Oakland County: Alameda
State: CA Zip: 94612

Table with 5 columns: Republic Services Approval #, Description of Waste, Volume/Weight, Expiration Date, Container Type. Row 1: 38251011244, Soil for disposal, 33.17 TN, 12-31-2011, Tractor with Dump Trailer(s).

*Attach Additional Sheet if necessary

I hereby certify that the above-described materials are non-hazardous wastes as defined by 40 CFR 261 or any applicable state law. Further, that the above named materials are properly classified, described, packaged, marked and labeled, and are in proper condition for transportation according to the applicable regulations of the Department of Transportation.

Susan Crowley (Signature)
Generator/Authorized Agent Name Signature Date Shipped

TRANSPORTER INFORMATION

Transporter Name: Las Vegas Paving DOT # 191949
Address: 4420 S. Decatur Truck Number: 125
Las Vegas, NV 89103 Phone Number: (702) 353-4355

I certify no hazardous waste or other regulated substance was knowingly introduced to the waste while in my custody. The waste transported in this vehicle is the waste identified above, to the best of my knowledge.

Calvin Pagayo (Signature)
Name of Authorized Agent Signature Date Delivered 10-04-10

DISPOSAL SITE INFORMATION

Site Name: Apex Regional Landfill Phone No. (702) 599-5920
Address: 13550 U.S. Hwy 93 Las Vegas, NV

I hereby acknowledge receipt of the above described materials
JASON CARTER (Signature)
Name (Print or Type) Signature Date Received 10/4/10

81 Environmental Tech
13550 N Highway 93
Las Vegas, NV 89165

Ticket Type: INBOUND INVOICE

Ticket Number: 1664
Date: 10/04/2010
Time In: 8:05 pm
Time Out: 8:30 pm

Customer: 001011 - NGE, LLC c/o Northgate Environ Mgmt

Vehicle/Container: 81495P
Contract: Northgate Env. On Site Soils 3825 14
Comment: ~~475~~ 3825-10-1244

Gross Weight: 123,500 LB Manual In
Tare Weight: 51,040 LB Manual Out
Net Weight: 72460 LB
Net Tons: 36.23

BOL: 11762

Origin	Yards	Material	Billing	Quantity
Not Applicable	0.00 YD	SW CONTAMINATED SOIL	36.23	TN

Driver:



Weighmaster:

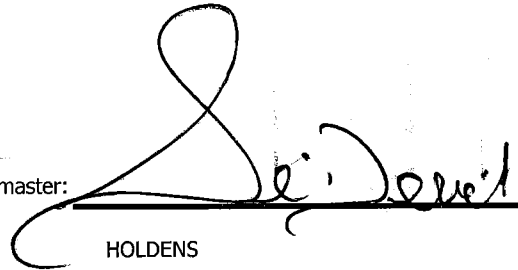

HOLDENS

Indemnification. Customer agrees, by signature above, to indemnify, hold harmless, and defend Republic Services, Inc., its subsidiaries, affiliates, employees, officers and directors from and against any and all liabilities, claims, penalties, forfeitures, suits and the costs and expenses incident thereto, including costs of defense, settlement, and reasonable attorney's fees, which may be incurred, as a result of death or injuries to any person, or damage to any property, contamination of or adverse effects on the environment, caused in whole or in part by the Customer, its employees, or subcontractors in disposing waste at this Facility. In the event Customer delivers Unacceptable Waste (as determined by Republic) Customer agrees to assume all expenses and obligations with the removal and/or resolution of any effects caused by the delivery of such Unacceptable Waste.

Indemnización. Cliente acuerda indemnizar, mantener inmune, y defender Republic Services, Inc., sus subsidiarios, compañías, divisiones, empleados, oficiales y directores contra de cualquiera y de todas responsabilidades, demandas, penas, pérdidas, juicios, pleitos y los costos incidente además, incluyendo costos de defensa, de acuerdo judicial, y de honorarios razonables del abogado, que pueden ser incurridos en, o como resultado de, la muerte o herida personal a cualquier persona, o daños a cualquier característica, propiedad, contaminación de la tierra o efectos ilícitos en esta Facilidad, causado entero o en parte por el cliente, sus empleados, o sus subcontratistas en botar basura en esta Facilidad. En el caso que el Cliente entrega, bota, basura (según lo determinado por Republic) en este Establecimiento basura inaceptable en los reglamentos de este Establecimiento, el Cliente se compromete asumir todos los costos y obligaciones con el retiro y/o la resolución de cualquier dano(s) causado por la entrega de tal basura inaceptable.



SR 40176

NON-HAZARDOUS WASTE MANIFEST

MANIFEST # 11762

GENERATOR INFORMATION

Generator Name: Tronox LLC
Address: P.O. Box 55
City: Henderson County: Clark
State: NV Zip: 89009
Site Location (if different): 560 W. Lake Mead
Henderson, NV 89015 (702) 592-7727

CUSTOMER/BILLING INFORMATION

Billing Name: NGE LLC c/o Northgate Environment Management
Address: 300 Frank Ogawa Plaza, Ste 510
City: Oakland County: Alameda
State: CA Zip: 94612

Table with 5 columns: Republic Services Approval #, Description of Waste, Volume/Weight, Expiration Date, Container Type. Row 1: 38251011244, Soil for disposal, 36.23 TAJ, 12-31-2011, Tractor with Dump Trailer(s)

*Attach Additional Sheet if necessary

I hereby certify that the above-described materials are non-hazardous wastes as defined by 40 CFR 261 or any applicable state law. Further, that the above named materials are properly classified, described, packaged, marked and labeled, and are in proper condition for transportation according to the applicable regulations of the Department of Transportation.

Susan Crowley (Signature)
Generator/Authorized Agent Name Signature Date Shipped

TRANSPORTER INFORMATION

Transporter Name: Las Vegas Paving DOT # 191949
Address: 4420 S. Decatur Truck Number: 175
Las Vegas, NV 89103 Phone Number: (702) 353-4355

I certify no hazardous waste or other regulated substance was knowingly introduced to the waste while in my custody. The waste transported in this vehicle is the waste identified above, to the best of my knowledge.

Larry Herrnsberger (Signature)
Name of Authorized Agent Signature Date Delivered 10/4/10

DISPOSAL SITE INFORMATION

Site Name: Apex Regional Landfill Phone No. (702) 599-5920
Address: 13550 U.S. Hwy 93 Las Vegas, NV

I hereby acknowledge receipt of the above described materials
JASON CARTER (Signature)
Name (Print or Type) Signature Date Received 10/4/10

81 Environmental Tech
13550 N Highway 93
Las Vegas, NV 89165

Ticket Type: INBOUND INVOICE

Ticket Number: 1665
Date: 10/04/2010
Time In: 8:07 pm
Time Out: 8:33 pm

Customer: 001011 - NGE, LLC c/o Northgate Environ Mgmt

Vehicle/Container: 81496P
Contract: Northgate Env. On Site Soils 3825 11
Comment: 3825 10 11244

Gross Weight: 120,260 LB Manual In
Tare Weight: 50,220 LB Manual Out
Net Weight: 70040 LB
Net Tons: 35.02

BOL: 11763

Origin	Yards	Material	Billing	Quantity
Not Applicable	0.00 YD	SW CONTAMINATED SOIL	35.02	TN

Driver:

Weighmaster:

HOLDENS

Indemnification. Customer agrees, by signature above, to indemnify, hold harmless, and defend Republic Services, Inc., its subsidiaries, affiliates, employees, officers and directors from and against any and all liabilities, claims, penalties, forfeitures, suits and the costs and expenses incident thereto, including costs of defense, settlement, and reasonable attorney's fees, which may be incurred, as a result of death or injuries to any person, or damage to any property, contamination of or adverse effects on the environment, caused in whole or in part by the Customer, its employees, or subcontractors in disposing waste at this Facility. In the event Customer delivers Unacceptable Waste (as determined by Republic) Customer agrees to assume all expenses and obligations with the removal and/or resolution of any effects caused by the delivery of such Unacceptable Waste.

Indemnización. Cliente acuerda indemnizar, mantener inmune, y defender Republic Services, Inc., sus subsidiarios, compañías, divisiones, empleados, oficiales y directores contra de cualquiera y de todas responsabilidades, demandas, penas, pérdidas, juicios, pleitos y los costos incidente además, incluyendo costos de defensa, de acuerdo judicial, y de honorarios razonables del abogado, que pueden ser incurridos en, o como resultado de, la muerte o herida personal a cualquier persona, o daños a cualquier característica, propiedad, contaminación de la tierra o efectos ilícitos en esta Facilidad, causado entero o en parte por el cliente, sus empleados, o sus subcontratistas en botar basura en esta Facilidad. En el caso que el Cliente entrega, bota, basura (según lo determinado por Republic) en este Establecimiento basura inaceptable en los reglamentos de este Establecimiento, el Cliente se compromete asumir todos los costos y obligaciones con el retiro y/o la resolución de cualquier dano(s) causado por la entrega de tal basura inaceptable.



NON-HAZARDOUS WASTE MANIFEST

MANIFEST # 11763

GENERATOR INFORMATION

Generator Name: Tronox LLC
Address: P.O. Box 55
City: Henderson County: Clark
State: NV Zip: 89009
Site Location (if different): 560 W. Lake Mead
Henderson, NV 89015 (702) 592-7727

CUSTOMER/BILLING INFORMATION

Billing Name: NGE LLC c/o Northgate Environment Management
Address: 300 Frank Ogawa Plaza, Ste 510
City: Oakland County: Alameda
State: CA Zip: 94612

Table with 5 columns: Republic Services Approval #, Description of Waste, Volume/Weight, Expiration Date, Container Type. Row 1: 38251011244, Soil for disposal, 35.02 TN, 12-31-2011, Tractor with Dump Trailer(s). Row 2: RZ- #

*Attach Additional Sheet if necessary

I hereby certify that the above-described materials are non-hazardous wastes as defined by 40 CFR 261 or any applicable state law. Further, that the above named materials are properly classified, described, packaged, marked and labeled, and are in proper condition for transportation according to the applicable regulations of the Department of Transportation.

Susan Crowley (Signature)
Generator/Authorized Agent Name Signature Date Shipped

TRANSPORTER INFORMATION

Transporter Name: Las Vegas Paving DOT # 191949
Address: 4420 S. Decatur Truck Number: 145
Las Vegas, NV 89103 Phone Number: (702) 353-4355

I certify no hazardous waste or other regulated substance was knowingly introduced to the waste while in my custody. The waste transported in this vehicle is the waste identified above, to the best of my knowledge.

Harry M. Giel (Signature)
Name of Authorized Agent Signature Date Delivered 10-14-10

DISPOSAL SITE INFORMATION

Site Name: Apex Regional Landfill Phone No. (702) 599-5920
Address: 13550 U.S. Hwy 93 Las Vegas, NV

I hereby acknowledge receipt of the above described materials

JASON CARTER (Signature)
Name (Print or Type) Signature Date Received 10/4/10

81 Environmental Tech
13550 N Highway 93
Las Vegas, NV 89165

Ticket Type: INBOUND INVOICE

Ticket Number: 1666
Date: 10/04/2010
Time In: 8:11 pm
Time Out: 8:36 pm

Customer: 001011 - NGE, LLC c/o Northgate Environ Mgmt

Vehicle/Container: 81460P
Contract: Northgate Env. On Site Soils 3825 11
Comment: 3825 10 11244

Gross Weight: 122,080 LB Manual In
Tare Weight: 52,800 LB Manual Out
Net Weight: 69280 LB
Net Tons: 34.64

BOL: 11765

Origin	Yards	Material	Billing Quantity
Not Applicable	0.00 YD	SW CONTAMINATED SOIL	34.64 TN

Driver: _____

Weighmaster: _____

IN - CARTERJ OUT - HOLDENS

Indemnification. Customer agrees, by signature above, to indemnify, hold harmless, and defend Republic Services, Inc., its subsidiaries, affiliates, employees, officers and directors from and against any and all liabilities, claims, penalties, forfeitures, suits and the costs and expenses incident thereto, including costs of defense, settlement, and reasonable attorney's fees, which may be incurred, as a result of death or injuries to any person, or damage to any property, contamination of or adverse effects on the environment, caused in whole or in part by the Customer, its employees, or subcontractors in disposing waste at this Facility. In the event Customer delivers Unacceptable Waste (as determined by Republic) Customer agrees to assume all expenses and obligations with the removal and/or resolution of any effects caused by the delivery of such Unacceptable Waste.

Indemnización. Cliente acuerda indemnizar, mantener inmune, y defender Republic Services, Inc., sus subsidiarios, compañías, divisiones, empleados, oficiales y directores contra de cualquiera y de todas responsabilidades, demandas, penas, pérdidas, juicios, pleitos y los costos incidente además, incluyendo costos de defensa, de acuerdo judicial, y de honorarios razonables del abogado, que pueden ser incurridos en, o como resultado de, la muerte o herida personal a cualquier persona, o daños a cualquier característica, propiedad, contaminación de la tierra o efectos ilícitos en esta Facilidad, causado entero o en parte por el cliente, sus empleados, o sus subcontratistas en botar basura en esta Facilidad. En el caso que el Cliente entrega, bota, basura (según lo determinado por Republic) en este Establecimiento basura inaceptable en los reglamentos de este Establecimiento, el Cliente se compromete asumir todos los costos y obligaciones con el retiro y/o la resolución de cualquier dano(s) causado por la entrega de tal basura inaceptable.



NON-HAZARDOUS WASTE MANIFEST

MANIFEST # 11765

GENERATOR INFORMATION

Generator Name: Tronox LLC
Address: P.O. Box 55
City: Henderson County: Clark
State: NV Zip: 89009
Site Location (if different): 560 W. Lake Mead
Henderson, NV 89015 (702) 592-7727

CUSTOMER/BILLING INFORMATION

Billing Name: NGE LLC c/o Northgate Environment Management
Address: 300 Frank Ogawa Plaza, Ste 510
City: Oakland County: Alameda
State: CA Zip: 94612

Table with 5 columns: Republic Services Approval #, Description of Waste, Volume/Weight, Expiration Date, Container Type. Row 1: 38251011244, Soil for disposal, 34.64 TN, 12-31-2011, Tractor with Dump Trailer(s). Row 2: RZ- #

*Attach Additional Sheet if necessary

I hereby certify that the above-described materials are non-hazardous wastes as defined by 40 CFR 261 or any applicable state law. Further, that the above named materials are properly classified, described, packaged, marked and labeled, and are in proper condition for transportation according to the applicable regulations of the Department of Transportation.

Susan Crowley (Signature)
Generator/Authorized Agent Name Signature Date Shipped

TRANSPORTER INFORMATION

Transporter Name: Las Vegas Paving DOT # 191949
Address: 4420 S. Decatur Truck Number: 27
Las Vegas, NV 89103 Phone Number: (702) 353-4355

I certify no hazardous waste or other regulated substance was knowingly introduced to the waste while in my custody. The waste transported in this vehicle is the waste identified above, to the best of my knowledge.

Daniel Cardenas (Signature)
Name of Authorized Agent Signature Date Delivered 10-4-2010

DISPOSAL SITE INFORMATION

Site Name: Apex Regional Landfill Phone No. (702) 599-5920
Address: 13550 U.S. Hwy 93 Las Vegas, NV

I hereby acknowledge receipt of the above described materials
JASON CARTA (Signature)
Name (Print or Type) Signature Date Received 10/4/10

81 Environmental Tech
13550 N Highway 93
Las Vegas, NV 89165

Ticket Type: INBOUND INVOICE

Ticket Number: 1667
Date: 10/04/2010
Time In: 8:14 pm
Time Out: 8:42 pm

Customer: 001011 - NGE, LLC c/o Northgate Environ Mgmt

Vehicle/Container: 44564A
Contract: Northgate Env. On Site Soils 3825 11
Comment: 3825 10 11244

Gross Weight: 128,360 LB Manual In
Tare Weight: 49,360 LB Manual Out
Net Weight: 79000 LB
Net Tons: 39.50

BOL: 11764

Origin	Yards	Material	Billing	Quantity
Not Applicable	0.00 YD	SW CONTAMINATED SOIL	39.50	TN

Driver: _____



Weighmaster: _____

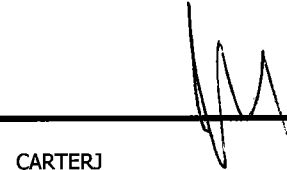

CARTERJ

Indemnification. Customer agrees, by signature above, to indemnify, hold harmless, and defend Republic Services, Inc., its subsidiaries, affiliates, employees, officers and directors from and against any and all liabilities, claims, penalties, forfeitures, suits and the costs and expenses incident thereto, including costs of defense, settlement, and reasonable attorney's fees, which may be incurred, as a result of death or injuries to any person, or damage to any property, contamination of or adverse effects on the environment, caused in whole or in part by the Customer, its employees, or subcontractors in disposing waste at this Facility. In the event Customer delivers Unacceptable Waste (as determined by Republic) Customer agrees to assume all expenses and obligations with the removal and/or resolution of any effects caused by the delivery of such Unacceptable Waste.

Indemnización. Cliente acuerda indemnizar, mantener inmune, y defender Republic Services, Inc., sus subsidiarios, compañías, divisiones, empleados, oficiales y directores contra de cualquiera y de todas responsabilidades, demandas, penas, pérdidas, juicios, pleitos y los costos incidente además, incluyendo costos de defensa, de acuerdo judicial, y de honorarios razonables del abogado, que pueden ser incurridos en, o como resultado de, la muerte o herida personal a cualquier persona, o daños a cualquier característica, propiedad, contaminación de la tierra o efectos ilícitos en esta Facilidad, causado entero o en parte por el cliente, sus empleados, o sus subcontratistas en botar basura en esta Facilidad. En el caso que el Cliente entrega, bota, basura (según lo determinado por Republic) en este Establecimiento basura inaceptable en los reglamentos de este Establecimiento, el Cliente se compromete asumir todos los costos y obligaciones con el retiro y/o la resolución de cualquier dano(s) causado por la entrega de tal basura inaceptable.



NON-HAZARDOUS WASTE MANIFEST

MANIFEST # 11764

GENERATOR INFORMATION

Generator Name: Tronox LLC
Address: P.O. Box 55
City: Henderson County: Clark
State: NV Zip: 89009
Site Location (if different): 560 W. Lake Mead
Henderson, NV 89015 (702) 592-7727

CUSTOMER/BILLING INFORMATION

Billing Name: NGE LLC c/o Northgate Environment Management
Address: 300 Frank Ogawa Plaza, Ste 510
City: Oakland County: Alameda
State: CA Zip: 94612

Table with 5 columns: Republic Services Approval #, Description of Waste, Volume/Weight, Expiration Date, Container Type. Row 1: 38251011244, Soil for disposal, 39.50 TN, 12-31-2011, Tractor with Dump Trailer(s). Row 2: RZ- #

*Attach Additional Sheet if necessary

I hereby certify that the above-described materials are non-hazardous wastes as defined by 40 CFR 261 or any applicable state law. Further, that the above named materials are properly classified, described, packaged, marked and labeled, and are in proper condition for transportation according to the applicable regulations of the Department of Transportation.

Susan Crowley
Generator/Authorized Agent Name Signature Date Shipped

TRANSPORTER INFORMATION

Transporter Name: Las Vegas Paving DOT # 191949
Address: 4420 S. Decatur Truck Number: K-003
Las Vegas, NV 89103 Phone Number: (702) 353-4355

I certify no hazardous waste or other regulated substance was knowingly introduced to the waste while in my custody. The waste transported in this vehicle is the waste identified above, to the best of my knowledge.

Asencio
Name of Authorized Agent Signature Date Delivered 10/4/10

DISPOSAL SITE INFORMATION

Site Name: Apex Regional Landfill Phone No. (702) 599-5920
Address: 13550 U.S. Hwy 93 Las Vegas, NV

I hereby acknowledge receipt of the above described materials

JASON CARTER
Name (Print or Type) Signature Date Received 10/4/10

81 Environmental Tech
13550 N Highway 93
Las Vegas, NV 89165

Ticket Type: INBOUND INVOICE

Ticket Number: 1668
Date: 10/04/2010
Time In: 8:21 pm
Time Out: 8:43 pm

Customer: 001011 - NGE, LLC c/o Northgate Environ Mgmt

Vehicle/Container: 84598P
Contract: Northgate Env. On Site Soils 3825 11
Comment: 3825 10 11244

Gross Weight: 125,700 LB Manual In
Tare Weight: 52,360 LB Manual Out
Net Weight: 73340 LB
Net Tons: 36.67

BOL: 11766

Origin	Yards	Material	Billing Quantity
Not Applicable	0.00 YD	SW CONTAMINATED SOIL	36.67 TN

Driver: _____

Weighmaster: _____

HOLDENS

Indemnification. Customer agrees, by signature above, to indemnify, hold harmless, and defend Republic Services, Inc., its subsidiaries, affiliates, employees, officers and directors from and against any and all liabilities, claims, penalties, forfeitures, suits and the costs and expenses incident thereto, including costs of defense, settlement, and reasonable attorney's fees, which may be incurred, as a result of death or injuries to any person, or damage to any property, contamination of or adverse effects on the environment, caused in whole or in part by the Customer, its employees, or subcontractors in disposing waste at this Facility. In the event Customer delivers Unacceptable Waste (as determined by Republic) Customer agrees to assume all expenses and obligations with the removal and/or resolution of any effects caused by the delivery of such Unacceptable Waste.

Indemnización. Cliente acuerda indemnizar, mantener inmune, y defender Republic Services, Inc., sus subsidiarios, compañías, divisiones, empleados, oficiales y directores contra de cualquiera y de todas responsabilidades, demandas, penas, pérdidas, juicios, pleitos y los costos incidente además, incluyendo costos de defensa, de acuerdo judicial, y de honorarios razonables del abogado, que pueden ser incurridos en, o como resultado de, la muerte o herida personal a cualquier persona, o daños a cualquier característica, propiedad, contaminación de la tierra o efectos ilícitos en esta Facilidad, causado entero o en parte por el cliente, sus empleados, o sus subcontratistas en botar basura en esta Facilidad. En el caso que el Cliente entrega, bota, basura (según lo determinado por Republic) en este Establecimiento basura inaceptable en los reglamentos de este Establecimiento, el Cliente se compromete asumir todos los costos y obligaciones con el retiro y/o la resolución de cualquier dano(s) causado por la entrega de tal basura inaceptable.



NON-HAZARDOUS WASTE MANIFEST

MANIFEST # 11766

GENERATOR INFORMATION

Generator Name: Tronox LLC

Address: P.O. Box 55

City: Henderson County: Clark

State: NV Zip: 89009

Site Location (if different): 560 W. Lake Mead
Henderson, NV 89015 (702) 592-7727

CUSTOMER/BILLING INFORMATION

Billing Name: NGE LLC c/o Northgate Environment Management

Address: 300 Frank Ogawa Plaza, Ste 510

City: Oakland County: Alameda

State: CA Zip: 94612

Table with 5 columns: Republic Services Approval #, Description of Waste, Volume/Weight, Expiration Date, Container Type. Row 1: 38251011244, Soil for disposal, 36 47/107, 12-31-2011, Tractor with Dump Trailer(s).

*Attach Additional Sheet if necessary

I hereby certify that the above-described materials are non-hazardous wastes as defined by 40 CFR 261 or any applicable state law. Further, that the above named materials are properly classified, described, packaged, marked and labeled, and are in proper condition for transportation according to the applicable regulations of the Department of Transportation.

Susan Crowley (Name), [Signature] (Signature), Date Shipped

TRANSPORTER INFORMATION

Transporter Name: Las Vegas Paving

DOT # 191949

Address: 4420 S. Decatur

Truck Number: 28

Las Vegas, NV 89103

Phone Number: (702) 353-4355

I certify no hazardous waste or other regulated substance was knowingly introduced to the waste while in my custody. The waste transported in this vehicle is the waste identified above, to the best of my knowledge.

[Signature] (Name of Authorized Agent), [Signature] (Signature), 10-11-10 (Date Delivered)

DISPOSAL SITE INFORMATION

Site Name: Apex Regional Landfill

Phone No. (702) 599-5920

Address: 13550 U.S. Hwy 93 Las Vegas, NV

I hereby acknowledge receipt of the above described materials. Holden, Se' Der' ch (Name), [Signature] (Signature), 04 Oct 10 (Date Received)

81 Environmental Tech
13550 N Highway 93
Las Vegas, NV 89165

Ticket Type: INBOUND INVOICE

Ticket Number: 1669
Date: 10/04/2010
Time In: 8:21 pm
Time Out: 8:45 pm

Customer: 001011 - NGE, LLC c/o Northgate Environ Mgmt

Vehicle/Container: 76810P
Contract: Northgate Env. On Site Soils 3825 11
Comment: 3825 10 11244

Gross Weight: 126,120 LB Manual In
Tare Weight: 54,860 LB Manual Out
Net Weight: 71260 LB
Net Tons: 35.63

BOL: 11767

Origin	Yards	Material	Billing	Quantity
Not Applicable	0.00 YD	SW CONTAMINATED SOIL	35.63	TN

Driver:

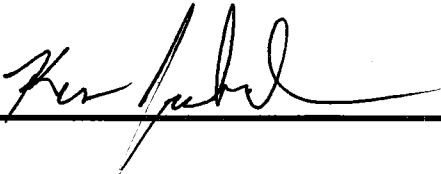

Weighmaster:

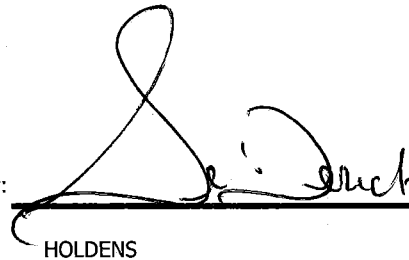

HOLDENS

Indemnification. Customer agrees, by signature above, to indemnify, hold harmless, and defend Republic Services, Inc., its subsidiaries, affiliates, employees, officers and directors from and against any and all liabilities, claims, penalties, forfeitures, suits and the costs and expenses incident thereto, including costs of defense, settlement, and reasonable attorney's fees, which may be incurred, as a result of death or injuries to any person, or damage to any property, contamination of or adverse effects on the environment, caused in whole or in part by the Customer, its employees, or subcontractors in disposing waste at this Facility. In the event Customer delivers Unacceptable Waste (as determined by Republic) Customer agrees to assume all expenses and obligations with the removal and/or resolution of any effects caused by the delivery of such Unacceptable Waste.

Indemnización. Cliente acuerda indemnizar, mantener inmune, y defender Republic Services, Inc., sus subsidiarios, companias, divisiones, empleados, oficiales y directores contra de cualquiera y de todas responsabilidades, demandas, penas, pérdidas, juicios, pleitos y los costos incidente además, incluyendo costos de defensa, de acuerdo judicial, y de honorarios razonables del abogado, que pueden ser incurridos en, o como resultado de, la muerte o herida personal a cualquier persona, o daños a cualquier característica, propiedad, contaminación de la tierra o efectos ilicitos en esta Facilidat, causado entero o en parte por el cliente, sus empleados, o sus subcontratistas en botar basura en esta Facilidat. En el caso que el Cliente entrega, bota, basura (según lo determinado por Republic) en este Establecimiento basura inaceptable en los reglamentos de este Establecimiento, el Cliente se compromete asumir todos los costos y obligaciones con el retiro y/o la resolución de cualquier dano(s) causado por la entrega de tal basura inaceptable.



NON-HAZARDOUS WASTE MANIFEST

MANIFEST # 11767

GENERATOR INFORMATION

Generator Name: Tronox LLC
Address: P.O. Box 55
City: Henderson County: Clark
State: NV Zip: 89009
Site Location (if different): 560 W. Lake Mead
Henderson, NV 89015 (702) 592-7727

CUSTOMER/BILLING INFORMATION

Billing Name: NGE LLC c/o Northgate Environment Management
Address: 300 Frank Ogawa Plaza, Ste 510
City: Oakland County: Alameda
State: CA Zip: 94612

Table with 5 columns: Republic Services Approval #, Description of Waste, Volume/Weight, Expiration Date, Container Type. Row 1: 38251011244, Soil for disposal, 12-31-2011, Tractor with Dump Trailer(s). Row 2: RZ- #

*Attach Additional Sheet if necessary

I hereby certify that the above-described materials are non-hazardous wastes as defined by 40 CFR 261 or any applicable state law. Further, that the above named materials are properly classified, described, packaged, marked and labeled, and are in proper condition for transportation according to the applicable regulations of the Department of Transportation.

Susan Crowley
Generator/Authorized Agent Name Signature Date Shipped

TRANSPORTER INFORMATION

Transporter Name: Las Vegas Paving DOT # 191949
Address: 4420 S. Decatur Truck Number: 241
Las Vegas, NV 89103 Phone Number: (702) 353-4355

I certify no hazardous waste or other regulated substance was knowingly introduced to the waste while in my custody. The waste transported in this vehicle is the waste identified above, to the best of my knowledge.

Name of Authorized Agent Signature Date Delivered

DISPOSAL SITE INFORMATION

Site Name: Apex Regional Landfill Phone No. (702) 599-5920
Address: 13550 U.S. Hwy 93 Las Vegas, NV

I hereby acknowledge receipt of the above described materials
Name (Print or Type) Signature Date Received

REPRINT

81 Environmental Tech
13550 N Highway 93
Las Vegas, NV 89165

Ticket Type: INBOUND INVOICE

Ticket Number: 1670
Date: 10/04/2010
Time In: 8:22 pm
Time Out: 8:45 pm

Customer: 001011 - NGE, LLC c/o Northgate Environ Mgmt

Vehicle/Container: 82418P
Contract: Northgate Env. On Site Soils 3825 11
Comment: 3825 10 11244

Gross Weight: 132,600 LB Manual In
Tare Weight: 61,480 LB Manual Out
Net Weight: 71120 LB
Net Tons: 35.56

BOL: 11768

Origin	Yards	Material	Billing	Quantity
Not Applicable	0.00 YD	SW CONTAMINATED SOIL	35.56	TN

Driver:

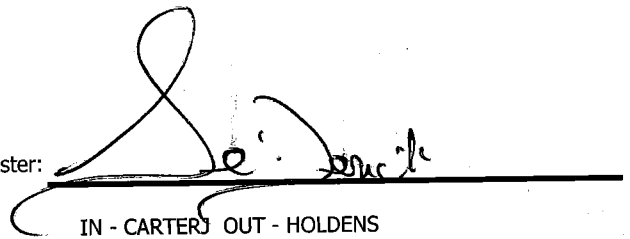

Weighmaster:

IN - CARTERJ OUT - HOLDENS

Indemnification. Customer agrees, by signature above, to indemnify, hold harmless, and defend Republic Services, Inc., its subsidiaries, affiliates, employees, officers and directors from and against any and all liabilities, claims, penalties, forfeitures, suits and the costs and expenses incident thereto, including costs of defense, settlement, and reasonable attorney's fees, which may be incurred, as a result of death or injuries to any person, or damage to any property, contamination of or adverse effects on the environment, caused in whole or in part by the Customer, its employees, or subcontractors in disposing waste at this Facility. In the event Customer delivers Unacceptable Waste (as determined by Republic) Customer agrees to assume all expenses and obligations with the removal and/or resolution of any effects caused by the delivery of such Unacceptable Waste.

Indemnización. Cliente acuerda indemnizar, mantener inmune, y defender Republic Services, Inc., sus subsidiarios, compañías, divisiones, empleados, oficiales y directores contra de cualquiera y de todas responsabilidades, demandas, penas, pérdidas, juicios, pleitos y los costos incidente además, incluyendo costos de defensa, de acuerdo judicial, y de honorarios razonables del abogado, que pueden ser incurridos en, o como resultado de, la muerte o herida personal a cualquier persona, o daños a cualquier característica, propiedad, contaminación de la tierra o efectos ilícitos en esta Facilidad, causado entero o en parte por el cliente, sus empleados, o sus subcontratistas en botar basura en esta Facilidad. En el caso que el Cliente entrega, bota, basura (según lo determinado por Republic) en este Establecimiento basura inaceptable en los reglamentos de este Establecimiento, el Cliente se compromete asumir todos los costos y obligaciones con el retiro y/o la resolución de cualquier dano(s) causado por la entrega de tal basura inaceptable.



NON-HAZARDOUS WASTE MANIFEST

MANIFEST # 11768

GENERATOR INFORMATION

Generator Name: Tronox LLC
Address: P.O. Box 55
City: Henderson County: Clark
State: NV Zip: 89009
Site Location (if different): 560 W. Lake Mead
Henderson, NV 89015 (702) 592-7727

CUSTOMER/BILLING INFORMATION

Billing Name: NGE LLC c/o Northgate Environment Management
Address: 300 Frank Ogawa Plaza, Ste 510
City: Oakland County: Alameda
State: CA Zip: 94612

Table with 5 columns: Republic Services Approval #, Description of Waste, Volume/Weight, Expiration Date, Container Type. Row 1: 38251011244, Soil for disposal, 12-31-2011, Tractor with Dump Trailer(s).

*Attach Additional Sheet if necessary

I hereby certify that the above-described materials are non-hazardous wastes as defined by 40 CFR 261 or any applicable state law. Further, that the above named materials are properly classified, described, packaged, marked and labeled, and are in proper condition for transportation according to the applicable regulations of the Department of Transportation.

Susan Crowley (Signature)
Generator/Authorized Agent Name Signature Date Shipped

TRANSPORTER INFORMATION

Transporter Name: Las Vegas Paving DOT # 191949
Address: 4420 S. Decatur Truck Number: 220
Las Vegas, NV 89103 Phone Number: (702) 353-4355

I certify no hazardous waste or other regulated substance was knowingly introduced to the waste while in my custody. The waste transported in this vehicle is the waste identified above, to the best of my knowledge.

STEVE TAYLOR (Signature)
Name of Authorized Agent Signature Date Delivered 10-4-10

DISPOSAL SITE INFORMATION

Site Name: Apex Regional Landfill Phone No. (702) 599-5920
Address: 13550 U.S. Hwy 93 Las Vegas, NV

I hereby acknowledge receipt of the above described materials
Holden, S. Derek (Signature)
Name (Print or Type) Signature Date Received 04 Oct 10

81 Environmental Tech
13550 N Highway 93
Las Vegas, NV 89165

Ticket Type: INBOUND INVOICE

Ticket Number: 1671
Date: 10/04/2010
Time In: 8:32 pm
Time Out: 8:55 pm

Customer: 001011 - NGE, LLC c/o Northgate Environ Mgmt

Vehicle/Container: 86053P
Contract: Northgate Env. On Site Soils 3825 11
Comment: 3825 10 11244

Gross Weight: 123,940 LB Manual In
Tare Weight: 54,640 LB Manual Out
Net Weight: 69300 LB
Net Tons: 34.65

BOL: 11770

Origin	Yards	Material	Billing	Quantity
Not Applicable	0.00 YD	SW CONTAMINATED SOIL	34.65	TN

Driver: _____



Weighmaster: _____

CARTERJ

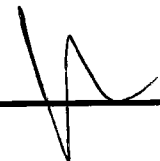

Indemnification. Customer agrees, by signature above, to indemnify, hold harmless, and defend Republic Services, Inc., its subsidiaries, affiliates, employees, officers and directors from and against any and all liabilities, claims, penalties, forfeitures, suits and the costs and expenses incident thereto, including costs of defense, settlement, and reasonable attorney's fees, which may be incurred, as a result of death or injuries to any person, or damage to any property, contamination of or adverse effects on the environment, caused in whole or in part by the Customer, its employees, or subcontractors in disposing waste at this Facility. In the event Customer delivers Unacceptable Waste (as determined by Republic) Customer agrees to assume all expenses and obligations with the removal and/or resolution of any effects caused by the delivery of such Unacceptable Waste.

Indemnización. Cliente acuerda indemnizar, mantener inmune, y defender Republic Services, Inc., sus subsidiarios, compañías, divisiones, empleados, oficiales y directores contra de cualquiera y de todas responsabilidades, demandas, penas, pérdidas, juicios, pleitos y los costos incidente además, incluyendo costos de defensa, de acuerdo judicial, y de honorarios razonables del abogado, que pueden ser incurridos en, o como resultado de, la muerte o herida personal a cualquier persona, o daños a cualquier característica, propiedad, contaminación de la tierra o efectos ilícitos en esta Facilidad, causado entero o en parte por el cliente, sus empleados, o sus subcontratistas en botar basura en esta Facilidad. En el caso que el Cliente entrega, bota, basura (según lo determinado por Republic) en este Establecimiento basura inaceptable en los reglamentos de este Establecimiento, el Cliente se compromete asumir todos los costos y obligaciones con el retiro y/o la resolución de cualquier dano(s) causado por la entrega de tal basura inaceptable.



NON-HAZARDOUS WASTE MANIFEST

MANIFEST # 11770

GENERATOR INFORMATION

Generator Name: Tronox LLC
Address: P.O. Box 55
City: Henderson County: Clark
State: NV Zip: 89009
Site Location (if different): 560 W. Lake Mead
Henderson, NV 89015 (702) 592-7727

CUSTOMER/BILLING INFORMATION

Billing Name: NGE LLC c/o Northgate Environment Management
Address: 300 Frank Ogawa Plaza, Ste 510
City: Oakland County: Alameda
State: CA Zip: 94612

Table with 5 columns: Republic Services Approval #, Description of Waste, Volume/Weight, Expiration Date, Container Type. Row 1: 38251011244, Soil for disposal, 34.65 TN, 12-31-2011, Tractor with Dump Trailer(s). Row 2: RZ- #

*Attach Additional Sheet if necessary

I hereby certify that the above-described materials are non-hazardous wastes as defined by 40 CFR 261 or any applicable state law. Further, that the above named materials are properly classified, described, packaged, marked and labeled, and are in proper condition for transportation according to the applicable regulations of the Department of Transportation.

Susan Crowley
Generator/Authorized Agent Name
Signature
Date Shipped

TRANSPORTER INFORMATION

Transporter Name: Las Vegas Paving DOT # 191949
Address: 4420 S. Decatur Truck Number: 261
Las Vegas, NV 89103 Phone Number: (702) 353-4355

I certify no hazardous waste or other regulated substance was knowingly introduced to the waste while in my custody. The waste transported in this vehicle is the waste identified above, to the best of my knowledge.

Name of Authorized Agent
Signature
Date Delivered

DISPOSAL SITE INFORMATION

Site Name: Apex Regional Landfill Phone No. (702) 599-5920
Address: 13550 U.S. Hwy 93 Las Vegas, NV

I hereby acknowledge receipt of the above described materials
Name (Print or Type) Signature Date Received

81 Environmental Tech
13550 N Highway 93
Las Vegas, NV 89165

Ticket Type: INBOUND INVOICE

Ticket Number: 1672
Date: 10/04/2010
Time In: 8:38 pm
Time Out: 9:04 pm

Customer: 001011 - NGE, LLC c/o Northgate Environ Mgmt

Vehicle/Container: 86113P
Contract: Northgate Env. On Site Soils 3825 11
Comment: 3825 10 11244

Gross Weight: 134,580 LB Manual In
Tare Weight: 55,740 LB Manual Out
Net Weight: 78840 LB
Net Tons: 39.42

BOL: 11771

Origin	Yards	Material	Billing Quantity
Not Applicable	0.00 YD	SW CONTAMINATED SOIL	39.42 TN

Driver:



Weighmaster:

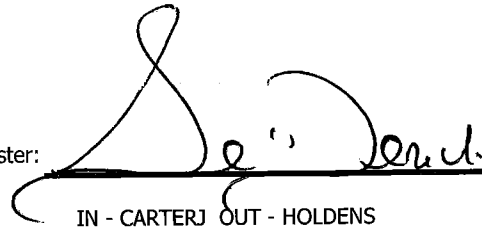

IN - CARTERJ OUT - HOLDENS

Indemnification. Customer agrees, by signature above, to indemnify, hold harmless, and defend Republic Services, Inc., its subsidiaries, affiliates, employees, officers and directors from and against any and all liabilities, claims, penalties, forfeitures, suits and the costs and expenses incident thereto, including costs of defense, settlement, and reasonable attorney's fees, which may be incurred, as a result of death or injuries to any person, or damage to any property, contamination of or adverse effects on the environment, caused in whole or in part by the Customer, its employees, or subcontractors in disposing waste at this Facility. In the event Customer delivers Unacceptable Waste (as determined by Republic) Customer agrees to assume all expenses and obligations with the removal and/or resolution of any effects caused by the delivery of such Unacceptable Waste.

Indemnización. Cliente acuerda indemnizar, mantener inmune, y defender Republic Services, Inc., sus subsidiarios, compañías, divisiones, empleados, oficiales y directores contra de cualquiera y de todas responsabilidades, demandas, penas, pérdidas, juicios, pleitos y los costos incidente además, incluyendo costos de defensa, de acuerdo judicial, y de honorarios razonables del abogado, que pueden ser incurridos en, o como resultado de, la muerte o herida personal a cualquier persona, o daños a cualquier característica, propiedad, contaminación de la tierra o efectos ilícitos en esta Facilidad, causado entero o en parte por el cliente, sus empleados, o sus subcontratistas en botar basura en esta Facilidad. En el caso que el Cliente entrega, bota, basura (según lo determinado por Republic) en este Establecimiento basura inaceptable en los reglamentos de este Establecimiento, el Cliente se compromete asumir todos los costos y obligaciones con el retiro y/o la resolución de cualquier dano(s) causado por la entrega de tal basura inaceptable.



NON-HAZARDOUS WASTE MANIFEST

MANIFEST # 11771

GENERATOR INFORMATION

Generator Name: Tronox LLC
Address: P.O. Box 55
City: Henderson County: Clark
State: NV Zip: 89009
Site Location (if different): 560 W. Lake Mead
Henderson, NV 89015 (702) 592-7727

CUSTOMER/BILLING INFORMATION

Billing Name: NGE LLC c/o Northgate Environment Management
Address: 300 Frank Ogawa Plaza, Ste 510
City: Oakland County: Alameda
State: CA Zip: 94612

Table with 5 columns: Republic Services Approval #, Description of Waste, Volume/Weight, Expiration Date, Container Type. Row 1: 38251011244, Soil for disposal, 39 42 lb, 12-31-2011, Tractor with Dump Trailer(s).

*Attach Additional Sheet if necessary

I hereby certify that the above-described materials are non-hazardous wastes as defined by 40 CFR 261 or any applicable state law. Further, that the above named materials are properly classified, described, packaged, marked and labeled, and are in proper condition for transportation according to the applicable regulations of the Department of Transportation.

Susan Crowley (Signature)
Generator/Authorized Agent Name Signature Date Shipped

TRANSPORTER INFORMATION

Transporter Name: Las Vegas Paving DOT # 191949
Address: 4420 S. Decatur Truck Number: K0019/7
Las Vegas, NV 89103 Phone Number: (702) 353-4355

I certify no hazardous waste or other regulated substance was knowingly introduced to the waste while in my custody. The waste transported in this vehicle is the waste identified above, to the best of my knowledge.

ALBERTO HERRERA (Signature)
Name of Authorized Agent Signature Date Delivered Oct 4, 2010

DISPOSAL SITE INFORMATION

Site Name: Apex Regional Landfill Phone No. (702) 599-5920
Address: 13550 U.S. Hwy 93 Las Vegas, NV

I hereby acknowledge receipt of the above described materials
Holden, Sr. Derek (Signature)
Name (Print or Type) Signature Date Received 04 Oct 2010

81 Environmental Tech
13550 N Highway 93
Las Vegas, NV 89165

Ticket Type: INBOUND INVOICE

Ticket Number: 1673
Date: 10/04/2010
Time In: 8:38 pm
Time Out: 9:06 pm

Customer: 001011 - NGE, LLC c/o Northgate Environ Mgmt

Vehicle/Container: 44165A
Contract: Northgate Env. On Site Soils 3825 11
Comment: 3825 10 11244

Gross Weight: 130,960 LB Manual In
Tare Weight: 48,920 LB Manual Out
Net Weight: 82040 LB
Net Tons: 41.02

BOL: 11769

Origin	Yards	Material	Billing	Quantity
Not Applicable	0.00 YD	SW CONTAMINATED SOIL	41.02	TN

Driver: _____



Weighmaster: _____

CARTERJ 

Indemnification. Customer agrees, by signature above, to indemnify, hold harmless, and defend Republic Services, Inc., its subsidiaries, affiliates, employees, officers and directors from and against any and all liabilities, claims, penalties, forfeitures, suits and the costs and expenses incident thereto, including costs of defense, settlement, and reasonable attorney's fees, which may be incurred, as a result of death or injuries to any person, or damage to any property, contamination of or adverse effects on the environment, caused in whole or in part by the Customer, its employees, or subcontractors in disposing waste at this Facility. In the event Customer delivers Unacceptable Waste (as determined by Republic) Customer agrees to assume all expenses and obligations with the removal and/or resolution of any effects caused by the delivery of such Unacceptable Waste.

Indemnización. Cliente acuerda indemnizar, mantener inmune, y defender Republic Services, Inc., sus subsidiarios, compañías, divisiones, empleados, oficiales y directores contra de cualquiera y de todas responsabilidades, demandas, penas, pérdidas, juicios, pleitos y los costos incidente además, incluyendo costos de defensa, de acuerdo judicial, y de honorarios razonables del abogado, que pueden ser incurridos en, o como resultado de, la muerte o herida personal a cualquier persona, o daños a cualquier característica, propiedad, contaminación de la tierra o efectos ilícitos en esta Facilidad, causado entero o en parte por el cliente, sus empleados, o sus subcontratistas en botar basura en esta Facilidad. En el caso que el Cliente entrega, bota, basura (según lo determinado por Republic) en este Establecimiento basura inaceptable en los reglamentos de este Establecimiento, el Cliente se compromete asumir todos los costos y obligaciones con el retiro y/o la resolución de cualquier dano(s) causado por la entrega de tal basura inaceptable.



NON-HAZARDOUS WASTE MANIFEST

MANIFEST # 11769

GENERATOR INFORMATION

Generator Name: Tronox LLC
Address: P.O. Box 55
City: Henderson County: Clark
State: NV Zip: 89009
Site Location (if different): 560 W. Lake Mead
Henderson, NV 89015 (702) 592-7727

CUSTOMER/BILLING INFORMATION

Billing Name: NGE LLC c/o Northgate Environment Management
Address: 300 Frank Ogawa Plaza, Ste 510
City: Oakland County: Alameda
State: CA Zip: 94612

Table with 5 columns: Republic Services Approval #, Description of Waste, Volume/Weight, Expiration Date, Container Type. Row 1: 38251011244, Soil for disposal, 41.02 TN, 12-31-2011, Tractor with Dump Trailer(s).

*Attach Additional Sheet if necessary

I hereby certify that the above-described materials are non-hazardous wastes as defined by 40 CFR 261 or any applicable state law. Further, that the above named materials are properly classified, described, packaged, marked and labeled, and are in proper condition for transportation according to the applicable regulations of the Department of Transportation.

Susan Crowley
Generator/Authorized Agent Name Signature Date Shipped

TRANSPORTER INFORMATION

Transporter Name: Las Vegas Paving DOT # 191949
Address: 4420 S. Decatur Truck Number: K001
Las Vegas, NV 89103 Phone Number: (702) 353-4355

I certify no hazardous waste or other regulated substance was knowingly introduced to the waste while in my custody. The waste transported in this vehicle is the waste identified above, to the best of my knowledge.

AREHARRC
Name of Authorized Agent Signature Date Delivered 10/04/10

DISPOSAL SITE INFORMATION

Site Name: Apex Regional Landfill Phone No. (702) 599-5920
Address: 13550 U.S. Hwy 93 Las Vegas, NV

I hereby acknowledge receipt of the above described materials
JASON CARTER
Name (Print or Type) Signature Date Received 10/4/10

81 Environmental Tech
13550 N Highway 93
Las Vegas, NV 89165

Ticket Type: INBOUND INVOICE

Ticket Number: 1674
Date: 10/04/2010
Time In: 8:41 pm
Time Out: 9:08 pm

Customer: 001011 - NGE, LLC c/o Northgate Environ Mgmt

Vehicle/Container: 68263P
Contract: Northgate Env. On Site Soils 3825 11
Comment: 3825 10 11244

Gross Weight: 127,520 LB Manual In
Tare Weight: 53,520 LB Manual Out
Net Weight: 74000 LB
Net Tons: 37.00

BOL: 11772

Origin	Yards	Material	Billing	Quantity
Not Applicable	0.00 YD	SW CONTAMINATED SOIL	37.00	TN

Driver:

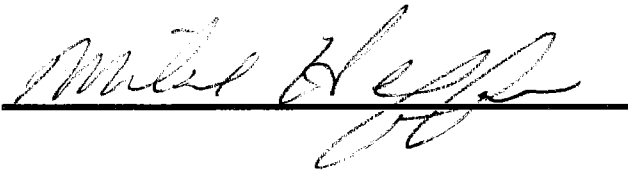

Weighmaster:



CARTERJ

Indemnification. Customer agrees, by signature above, to indemnify, hold harmless, and defend Republic Services, Inc., its subsidiaries, affiliates, employees, officers and directors from and against any and all liabilities, claims, penalties, forfeitures, suits and the costs and expenses incident thereto, including costs of defense, settlement, and reasonable attorney's fees, which may be incurred, as a result of death or injuries to any person, or damage to any property, contamination of or adverse effects on the environment, caused in whole or in part by the Customer, its employees, or subcontractors in disposing waste at this Facility. In the event Customer delivers Unacceptable Waste (as determined by Republic) Customer agrees to assume all expenses and obligations with the removal and/or resolution of any effects caused by the delivery of such Unacceptable Waste.

Indemnización. Cliente acuerda indemnizar, mantener inmune, y defender Republic Services, Inc., sus subsidiarios, compañías, divisiones, empleados, oficiales y directores contra de cualquiera y de todas responsabilidades, demandas, penas, pérdidas, juicios, pleitos y los costos incidente además, incluyendo costos de defensa, de acuerdo judicial, y de honorarios razonables del abogado, que pueden ser incurridos en, o como resultado de, la muerte o herida personal a cualquier persona, o daños a cualquier característica, propiedad, contaminación de la tierra o efectos ilícitos en esta Facilidad, causado entero o en parte por el cliente, sus empleados, o sus subcontratistas en botar basura en esta Facilidad. En el caso que el Cliente entrega, bota, basura (según lo determinado por Republic) en este Establecimiento basura inaceptable en los reglamentos de este Establecimiento, el Cliente se compromete asumir todos los costos y obligaciones con el retiro y/o la resolución de cualquier dano(s) causado por la entrega de tal basura inaceptable.



NON-HAZARDOUS WASTE MANIFEST

MANIFEST # 11772

GENERATOR INFORMATION

Generator Name: Tronox LLC

Address: P.O. Box 55

City: Henderson County: Clark

State: NV Zip: 89009

Site Location (if different): 560 W. Lake Mead
Henderson, NV 89015 (702) 592-7727

CUSTOMER/BILLING INFORMATION

Billing Name: NGE LLC c/o Northgate Environment Management

Address: 300 Frank Ogawa Plaza, Ste 510

City: Oakland County: Alameda

State: CA Zip: 94612

Table with 5 columns: Republic Services Approval #, Description of Waste, Volume/Weight, Expiration Date, Container Type. Row 1: 38251011244, Soil for disposal, 37.00 TN, 12-31-2011, Tractor with Dump Trailer(s). Row 2: RZ- #

*Attach Additional Sheet if necessary

I hereby certify that the above-described materials are non-hazardous wastes as defined by 40 CFR 261 or any applicable state law. Further, that the above named materials are properly classified, described, packaged, marked and labeled, and are in proper condition for transportation according to the applicable regulations of the Department of Transportation.

Susan Crowley (Signature)
Generator/Authorized Agent Name Signature Date Shipped

TRANSPORTER INFORMATION

Transporter Name: Las Vegas Paving

DOT # 191949

Address: 4420 S. Decatur

Truck Number: 2711

Las Vegas, NV 89103

Phone Number: (702) 353-4355

I certify no hazardous waste or other regulated substance was knowingly introduced to the waste while in my custody. The waste transported in this vehicle is the waste identified above, to the best of my knowledge.

Mike HeFERN (Signature)
Name of Authorized Agent Signature Date Delivered 10-11-10

DISPOSAL SITE INFORMATION

Site Name: Apex Regional Landfill

Phone No. (702) 599-5920

Address: 13550 U.S. Hwy 93 Las Vegas, NV

I hereby acknowledge receipt of the above described materials
JASON CARTER (Signature)
Name (Print or Type) Signature Date Received 10/11/10

81 Environmental Tech
13550 N Highway 93
Las Vegas, NV 89165

Ticket Type: INBOUND INVOICE

Ticket Number: 1675
Date: 10/04/2010
Time In: 8:45 pm
Time Out: 9:10 pm

Customer: 001011 - NGE, LLC c/o Northgate Environ Mgmt

Vehicle/Container: 76811P
Contract: Northgate Env. On Site Soils 3825 11
Comment: 3825 10 11244

Gross Weight: 123,200 LB Manual In
Tare Weight: 53,020 LB Manual Out
Net Weight: 70180 LB
Net Tons: 35.09

BOL: 11774

Origin	Yards	Material	Billing	Quantity
Not Applicable	0.00 YD	SW CONTAMINATED SOIL	35.09	TN

Driver: _____

Weighmaster: _____

IN - CARTERJ OUT - HOLDENS

Indemnification. Customer agrees, by signature above, to indemnify, hold harmless, and defend Republic Services, Inc., its subsidiaries, affiliates, employees, officers and directors from and against any and all liabilities, claims, penalties, forfeitures, suits and the costs and expenses incident thereto, including costs of defense, settlement, and reasonable attorney's fees, which may be incurred, as a result of death or injuries to any person, or damage to any property, contamination of or adverse effects on the environment, caused in whole or in part by the Customer, its employees, or subcontractors in disposing waste at this Facility. In the event Customer delivers Unacceptable Waste (as determined by Republic) Customer agrees to assume all expenses and obligations with the removal and/or resolution of any effects caused by the delivery of such Unacceptable Waste.

Indemnización. Cliente acuerda indemnizar, mantener inmune, y defender Republic Services, Inc., sus subsidiarios, compañías, divisiones, empleados, oficiales y directores contra de cualquiera y de todas responsabilidades, demandas, penas, pérdidas, juicios, pleitos y los costos incidente además, incluyendo costos de defensa, de acuerdo judicial, y de honorarios razonables del abogado, que pueden ser incurridos en, o como resultado de, la muerte o herida personal a cualquier persona, o daños a cualquier característica, propiedad, contaminación de la tierra o efectos ilícitos en esta Facilidad, causado entero o en parte por el cliente, sus empleados, o sus subcontratistas en botar basura en esta Facilidad. En el caso que el Cliente entrega, bota, basura (según lo determinado por Republic) en este Establecimiento basura inaceptable en los reglamentos de este Establecimiento, el Cliente se compromete asumir todos los costos y obligaciones con el retiro y/o la resolución de cualquier dano(s) causado por la entrega de tal basura inaceptable.



NON-HAZARDOUS WASTE MANIFEST

MANIFEST # 11774

GENERATOR INFORMATION

Generator Name: Tronox LLC
Address: P.O. Box 55
City: Henderson County: Clark
State: NV Zip: 89009
Site Location (if different): 560 W. Lake Mead
Henderson, NV 89015 (702) 592-7727

CUSTOMER/BILLING INFORMATION

Billing Name: NGE LLC c/o Northgate Environment Management
Address: 300 Frank Ogawa Plaza, Ste 510
City: Oakland County: Alameda
State: CA Zip: 94612

Table with 5 columns: Republic Services Approval #, Description of Waste, Volume/Weight, Expiration Date, Container Type. Row 1: 38251011244, Soil for disposal, 35 09/10n, 12-31-2011, Tractor with Dump Trailer(s).

*Attach Additional Sheet if necessary

I hereby certify that the above-described materials are non-hazardous wastes as defined by 40 CFR 261 or any applicable state law. Further, that the above named materials are properly classified, described, packaged, marked and labeled, and are in proper condition for transportation according to the applicable regulations of the Department of Transportation.

Susan Crowley
Generator/Authorized Agent Name Signature Date Shipped

TRANSPORTER INFORMATION

Transporter Name: Las Vegas Paving DOT # 191949
Address: 4420 S. Decatur Truck Number: 242
Las Vegas, NV 89103 Phone Number: (702) 353-4355

I certify no hazardous waste or other regulated substance was knowingly introduced to the waste while in my custody. The waste transported in this vehicle is the waste identified above, to the best of my knowledge.

STEVE NAYES
Name of Authorized Agent Signature Date Delivered 10-4-10

DISPOSAL SITE INFORMATION

Site Name: Apex Regional Landfill Phone No. (702) 599-5920
Address: 13550 U.S. Hwy 93 Las Vegas, NV

I hereby acknowledge receipt of the above described materials
Name (Print or Type) Signature Date Received 04 Oct 10

81 Environmental Tech
13550 N Highway 93
Las Vegas, NV 89165

Ticket Type: INBOUND INVOICE

Ticket Number: 1676
Date: 10/04/2010
Time In: 8:47 pm
Time Out: 9:16 pm

Customer: 001011 - NGE, LLC c/o Northgate Environ Mgmt

Vehicle/Container: 44166A
Contract: Northgate Env. On Site Soils 3825 10
Comment: 3825 10 11244

Gross Weight: 132,140 LB Manual In
Tare Weight: 57,360 LB Manual Out
Net Weight: 74780 LB
Net Tons: 37.39

BOL: 11773

Origin	Yards	Material	Billing Quantity
Not Applicable	0.00 YD	SW CONTAMINATED SOIL	37.39 TN

Driver: _____



Weighmaster: _____

CARTERJ

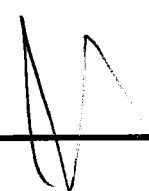

Indemnification. Customer agrees, by signature above, to indemnify, hold harmless, and defend Republic Services, Inc., its subsidiaries, affiliates, employees, officers and directors from and against any and all liabilities, claims, penalties, forfeitures, suits and the costs and expenses incident thereto, including costs of defense, settlement, and reasonable attorney's fees, which may be incurred, as a result of death or injuries to any person, or damage to any property, contamination of or adverse effects on the environment, caused in whole or in part by the Customer, its employees, or subcontractors in disposing waste at this Facility. In the event Customer delivers Unacceptable Waste (as determined by Republic) Customer agrees to assume all expenses and obligations with the removal and/or resolution of any effects caused by the delivery of such Unacceptable Waste.

Indemnización. Cliente acuerda indemnizar, mantener inmune, y defender Republic Services, Inc., sus subsidiarios, compañías, divisiones, empleados, oficiales y directores contra de cualquiera y de todas responsabilidades, demandas, penas, pérdidas, juicios, pleitos y los costos incidente además, incluyendo costos de defensa, de acuerdo judicial, y de honorarios razonables del abogado, que pueden ser incurridos en, o como resultado de, la muerte o herida personal a cualquier persona, o daños a cualquier característica, propiedad, contaminación de la tierra o efectos ilícitos en esta Facilidad, causado entero o en parte por el cliente, sus empleados, o sus subcontratistas en botar basura en esta Facilidad. En el caso que el Cliente entrega, bota, basura (según lo determinado por Republic) en este Establecimiento basura inaceptable en los reglamentos de este Establecimiento, el Cliente se compromete asumir todos los costos y obligaciones con el retiro y/o la resolución de cualquier dano(s) causado por la entrega de tal basura inaceptable.



NON-HAZARDOUS WASTE MANIFEST

MANIFEST # 11773

GENERATOR INFORMATION

Generator Name: Tronox LLC
Address: P.O. Box 55
City: Henderson County: Clark
State: NV Zip: 89009
Site Location (if different): 560 W. Lake Mead
Henderson, NV 89015 (702) 592-7727

CUSTOMER/BILLING INFORMATION

Billing Name: NGE LLC c/o Northgate Environment Management
Address: 300 Frank Ogawa Plaza, Ste 510
City: Oakland County: Alameda
State: CA Zip: 94612

Table with 5 columns: Republic Services Approval #, Description of Waste, Volume/Weight, Expiration Date, Container Type. Row 1: 38251011244, Soil for disposal, 37.39 TN, 12-31-2011, Tractor with Dump Trailer(s).

*Attach Additional Sheet if necessary

I hereby certify that the above-described materials are non-hazardous wastes as defined by 40 CFR 261 or any applicable state law. Further, that the above named materials are properly classified, described, packaged, marked and labeled, and are in proper condition for transportation according to the applicable regulations of the Department of Transportation.

Susan Crowley (Signature)
Generator/Authorized Agent Name Signature Date Shipped

TRANSPORTER INFORMATION

Transporter Name: Las Vegas Paving DOT # 191949
Address: 4420 S. Decatur Truck Number: 2002
Las Vegas, NV 89103 Phone Number: (702) 353-4355

I certify no hazardous waste or other regulated substance was knowingly introduced to the waste while in my custody. The waste transported in this vehicle is the waste identified above, to the best of my knowledge.

Angelo Castell (Signature)
Name of Authorized Agent Signature Date Delivered 10-4-10

DISPOSAL SITE INFORMATION

Site Name: Apex Regional Landfill Phone No. (702) 599-5920
Address: 13550 U.S. Hwy 93 Las Vegas, NV

I hereby acknowledge receipt of the above described materials
JASON CARTER (Signature)
Name (Print or Type) Signature Date Received 10/4/10

81 Environmental Tech
13550 N Highway 93
Las Vegas, NV 89165

Ticket Type: INBOUND INVOICE

Ticket Number: 1677
Date: 10/04/2010
Time In: 8:55 pm
Time Out: 9:28 pm

Customer: 001011 - NGE, LLC c/o Northgate Environ Mgmt

Vehicle/Container: 34330A
Contract: Northgate Env. On Site Soils 3825 11
Comment: 3825 10 11244

Gross Weight: 121,920 LB Manual In
Tare Weight: 53,020 LB Manual Out
Net Weight: 68900 LB
Net Tons: 34.45

BOL: 11776

Origin	Yards	Material	Billing	Quantity
Not Applicable	0.00 YD	SW CONTAMINATED SOIL	34.45	TN

Driver:

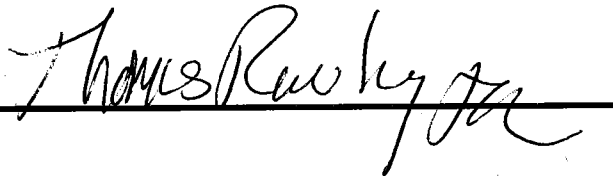

Weighmaster:

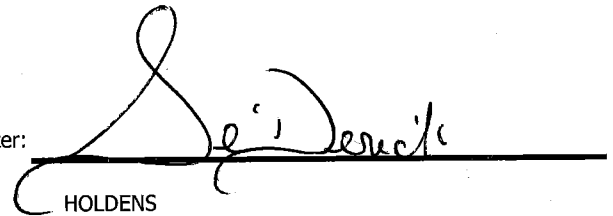

HOLDENS

Indemnification. Customer agrees, by signature above, to indemnify, hold harmless, and defend Republic Services, Inc., its subsidiaries, affiliates, employees, officers and directors from and against any and all liabilities, claims, penalties, forfeitures, suits and the costs and expenses incident thereto, including costs of defense, settlement, and reasonable attorney's fees, which may be incurred, as a result of death or injuries to any person, or damage to any property, contamination of or adverse effects on the environment, caused in whole or in part by the Customer, its employees, or subcontractors in disposing waste at this Facility. In the event Customer delivers Unacceptable Waste (as determined by Republic) Customer agrees to assume all expenses and obligations with the removal and/or resolution of any effects caused by the delivery of such Unacceptable Waste.

Indemnización. Cliente acuerda indemnizar, mantener inmune, y defender Republic Services, Inc., sus subsidiarios, compañías, divisiones, empleados, oficiales y directores contra de cualquiera y de todas responsabilidades, demandas, penas, pérdidas, juicios, pleitos y los costos incidente además, incluyendo costos de defensa, de acuerdo judicial, y de honorarios razonables del abogado, que pueden ser incurridos en, o como resultado de, la muerte o herida personal a cualquier persona, o daños a cualquier característica, propiedad, contaminación de la tierra o efectos ilícitos en esta Facilidad, causado entero o en parte por el cliente, sus empleados, o sus subcontratistas en botar basura en esta Facilidad. En el caso que el Cliente entrega, bota, basura (según lo determinado por Republic) en este Establecimiento basura inaceptable en los reglamentos de este Establecimiento, el Cliente se compromete asumir todos los costos y obligaciones con el retiro y/o la resolución de cualquier dano(s) causado por la entrega de tal basura inaceptable.



NON-HAZARDOUS WASTE MANIFEST

MANIFEST # 11776

GENERATOR INFORMATION

Generator Name: Tronox LLC
Address: P.O. Box 55
City: Henderson County: Clark
State: NV Zip: 89009
Site Location (if different): 560 W. Lake Mead
Henderson, NV 89015 (702) 592-7727

CUSTOMER/BILLING INFORMATION

Billing Name: NGE LLC c/o Northgate Environment Management
Address: 300 Frank Ogawa Plaza, Ste 510
City: Oakland County: Alameda
State: CA Zip: 94612

Table with 5 columns: Republic Services Approval #, Description of Waste, Volume/Weight, Expiration Date, Container Type. Row 1: 38251011244, Soil for disposal, 34 45 tons, 12-31-2011, Tractor with Dump Trailer(s).

*Attach Additional Sheet if necessary

I hereby certify that the above-described materials are non-hazardous wastes as defined by 40 CFR 261 or any applicable state law. Further, that the above named materials are properly classified, described, packaged, marked and labeled, and are in proper condition for transportation according to the applicable regulations of the Department of Transportation.

Susan Crowley (Signature)
Generator/Authorized Agent Name Signature Date Shipped

TRANSPORTER INFORMATION

Transporter Name: Las Vegas Paving DOT # 191949
Address: 4420 S. Decatur Truck Number: 981
Las Vegas, NV 89103 Phone Number: (702) 353-4355

I certify no hazardous waste or other regulated substance was knowingly introduced to the waste while in my custody. The waste transported in this vehicle is the waste identified above, to the best of my knowledge.

Tom Roeliga (Signature) Signature Date Delivered 10-4-10
Name of Authorized Agent Signature Date Delivered

DISPOSAL SITE INFORMATION

Site Name: Apex Regional Landfill Phone No. (702) 599-5920
Address: 13550 U.S. Hwy 93 Las Vegas, NV

I hereby acknowledge receipt of the above described materials
Holden, Se' Derrick (Signature) Signature Date Received 04 Oct 10
Name (Print or Type) Signature Date Received

81 Environmental Tech
13550 N Highway 93
Las Vegas, NV 89165

Ticket Type: INBOUND INVOICE

Ticket Number: 1678
Date: 10/04/2010
Time In: 8:57 pm
Time Out: 9:31 pm

Customer: 001011 - NGE, LLC c/o Northgate Environ Mgmt

Vehicle/Container: 44164A
Contract: Northgate Env. On Site Soils 3825 1I
Comment: 3825 10 11244

Gross Weight: 118,920 LB Manual In
Tare Weight: 56,220 LB Manual Out
Net Weight: 62,700 LB
Net Tons: 31.35

BOL: 11775

Origin	Yards	Material	Billing Quantity
Not Applicable	0.00 YD	SW CONTAMINATED SOIL	31.35 TN

Driver:

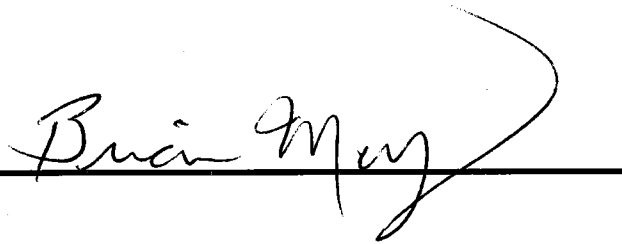

Weighmaster:

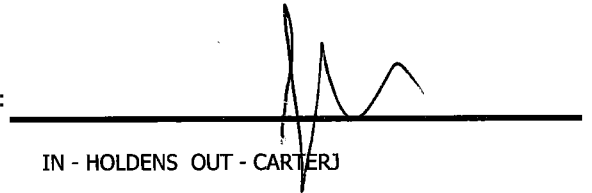

IN - HOLDENS OUT - CARTERJ

Indemnification. Customer agrees, by signature above, to indemnify, hold harmless, and defend Republic Services, Inc., its subsidiaries, affiliates, employees, officers and directors from and against any and all liabilities, claims, penalties, forfeitures, suits and the costs and expenses incident thereto, including costs of defense, settlement, and reasonable attorney's fees, which may be incurred, as a result of death or injuries to any person, or damage to any property, contamination of or adverse effects on the environment, caused in whole or in part by the Customer, its employees, or subcontractors in disposing waste at this Facility. In the event Customer delivers Unacceptable Waste (as determined by Republic) Customer agrees to assume all expenses and obligations with the removal and/or resolution of any effects caused by the delivery of such Unacceptable Waste.

Indemnización. Cliente acuerda indemnizar, mantener inmune, y defender Republic Services, Inc., sus subsidiarios, compañías, divisiones, empleados, oficiales y directores contra de cualquiera y de todas responsabilidades, demandas, penas, pérdidas, juicios, pleitos y los costos incidente además, incluyendo costos de defensa, de acuerdo judicial, y de honorarios razonables del abogado, que pueden ser incurridos en, o como resultado de, la muerte o herida personal a cualquier persona, o daños a cualquier característica, propiedad, contaminación de la tierra o efectos ilícitos en esta Facilidad, causado entero o en parte por el cliente, sus empleados, o sus subcontratistas en botar basura en esta Facilidad. En el caso que el Cliente entrega, bota, basura (según lo determinado por Republic) en este Establecimiento basura inaceptable en los reglamentos de este Establecimiento, el Cliente se compromete asumir todos los costos y obligaciones con el retiro y/o la resolución de cualquier dano(s) causado por la entrega de tal basura inaceptable.



NON-HAZARDOUS WASTE MANIFEST

MANIFEST # 11775

GENERATOR INFORMATION

Generator Name: Tronox LLC
Address: P.O. Box 55
City: Henderson County: Clark
State: NV Zip: 89009
Site Location (if different): 560 W. Lake Mead
Henderson, NV 89015 (702) 592-7727

CUSTOMER/BILLING INFORMATION

Billing Name: NGE LLC c/o Northgate Environment Management
Address: 300 Frank Ogawa Plaza, Ste 510
City: Oakland County: Alameda
State: CA Zip: 94612

Table with 5 columns: Republic Services Approval #, Description of Waste, Volume/Weight, Expiration Date, Container Type. Row 1: 38251011244, Soil for disposal, 31.35 TN, 12-31-2011, Tractor with Dump Trailer(s). Row 2: RZ- #

*Attach Additional Sheet if necessary

I hereby certify that the above-described materials are non-hazardous wastes as defined by 40 CFR 261 or any applicable state law. Further, that the above named materials are properly classified, described, packaged, marked and labeled, and are in proper condition for transportation according to the applicable regulations of the Department of Transportation.

Susan Crowley (Signature)
Generator/Authorized Agent Name Signature Date Shipped

TRANSPORTER INFORMATION

Transporter Name: Las Vegas Paving DOT # 191949
Address: 4420 S. Decatur Truck Number: K-006
Las Vegas, NV 89103 Phone Number: (702) 353-4355

I certify no hazardous waste or other regulated substance was knowingly introduced to the waste while in my custody. The waste transported in this vehicle is the waste identified above, to the best of my knowledge.

BRIAN Malvey (Signature)
Name of Authorized Agent Signature Date Delivered 10-9-10

DISPOSAL SITE INFORMATION

Site Name: Apex Regional Landfill Phone No. (702) 599-5920
Address: 13550 U.S. Hwy 93 Las Vegas, NV

I hereby acknowledge receipt of the above described materials
JASON CARTER (Signature)
Name (Print or Type) Signature Date Received 10/9/10

81 Environmental Tech
13550 N Highway 93
Las Vegas, NV 89165

Ticket Type: INBOUND INVOICE

Ticket Number: 1679
Date: 10/04/2010
Time In: 9:28 pm
Time Out: 9:51 pm

Customer: 001011 - NGE, LLC c/o Northgate Environ Mgmt

Vehicle/Container: 192457
Contract: Northgate Env. On Site Soils 3825 11
Comment: 3825 10 11244

Gross Weight: 124,160 LB Manual In
Tare Weight: 52,320 LB Manual Out
Net Weight: 71840 LB
Net Tons: 35.92

BOL 11777

Origin	Yards	Material	Billing Quantity
Not Applicable	0.00 YD	SW CONTAMINATED SOIL	35.92 TN

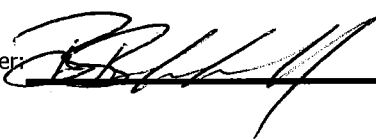
Driver: 

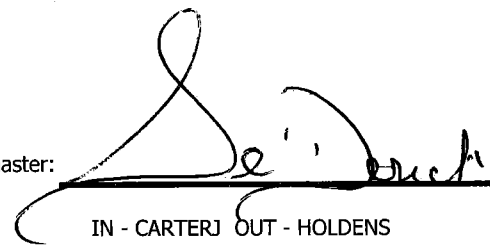
Weighmaster: 
IN - CARTERJ OUT - HOLDENS

Indemnification. Customer agrees, by signature above, to indemnify, hold harmless, and defend Republic Services, Inc., its subsidiaries, affiliates, employees, officers and directors from and against any and all liabilities, claims, penalties, forfeitures, suits and the costs and expenses incident thereto, including costs of defense, settlement, and reasonable attorney's fees, which may be incurred, as a result of death or injuries to any person, or damage to any property, contamination of or adverse effects on the environment, caused in whole or in part by the Customer, its employees, or subcontractors in disposing waste at this Facility. In the event Customer delivers Unacceptable Waste (as determined by Republic) Customer agrees to assume all expenses and obligations with the removal and/or resolution of any effects caused by the delivery of such Unacceptable Waste.

Indemnización. Cliente acuerda indemnizar, mantener inmune, y defender Republic Services, Inc., sus subsidiarios, compañías, divisiones, empleados, oficiales y directores contra de cualquiera y de todas responsabilidades, demandas, penas, pérdidas, juicios, pleitos y los costos incidente además, incluyendo costos de defensa, de acuerdo judicial, y de honorarios razonables del abogado, que pueden ser incurridos en, o como resultado de, la muerte o herida personal a cualquier persona, o daños a cualquier característica, propiedad, contaminación de la tierra o efectos ilícitos en esta Facilidad, causado entero o en parte por el cliente, sus empleados, o sus subcontratistas en botar basura en esta Facilidad. En el caso que el Cliente entrega, bota, basura (según lo determinado por Republic) en este Establecimiento basura inaceptable en los reglamentos de este Establecimiento, el Cliente se compromete asumir todos los costos y obligaciones con el retiro y/o la resolución de cualquier dano(s) causado por la entrega de tal basura inaceptable.



NON-HAZARDOUS WASTE MANIFEST

MANIFEST # 11777

GENERATOR INFORMATION

Generator Name: Tronox LLC
Address: P.O. Box 55
City: Henderson County: Clark
State: NV Zip: 89009
Site Location (if different): 560 W. Lake Mead
Henderson, NV 89015 (702) 592-7727

CUSTOMER/BILLING INFORMATION

Billing Name: NGE LLC c/o Northgate Environment Management
Address: 300 Frank Ogawa Plaza, Ste 510
City: Oakland County: Alameda
State: CA Zip: 94612

Table with 5 columns: Republic Services Approval #, Description of Waste, Volume/Weight, Expiration Date, Container Type. Row 1: 38251011244, Soil for disposal, 35 92/100, 12-31-2011, Tractor with Dump Trailer(s).

*Attach Additional Sheet if necessary

I hereby certify that the above-described materials are non-hazardous wastes as defined by 40 CFR 261 or any applicable state law. Further, that the above named materials are properly classified, described, packaged, marked and labeled, and are in proper condition for transportation according to the applicable regulations of the Department of Transportation.

Susan Crowley (Signature)
Generator/Authorized Agent Name Signature Date Shipped

TRANSPORTER INFORMATION

Transporter Name: Las Vegas Paving DOT # 191949
Address: 4420 S. Decatur Truck Number: 192457
Las Vegas, NV 89103 Phone Number: (702) 353-4355

I certify no hazardous waste or other regulated substance was knowingly introduced to the waste while in my custody. The waste transported in this vehicle is the waste identified above, to the best of my knowledge.

Brian Brinkhoff (Signature)
Name of Authorized Agent Signature Date Delivered 10-4-10

DISPOSAL SITE INFORMATION

Site Name: Apex Regional Landfill Phone No. (702) 599-5920
Address: 13550 U.S. Hwy 93 Las Vegas, NV

I hereby acknowledge receipt of the above described materials
Name (Print or Type) Signature Date Received 04 Oct 10

81 Environmental Tech
13550 N Highway 93
Las Vegas, NV 89165

Ticket Type: INBOUND INVOICE

Ticket Number: 1680
Date: 10/04/2010
Time In: 9:30 pm
Time Out: 9:56 pm

Customer: 001011 - NGE, LLC c/o Northgate Environ Mgmt

Vehicle/Container: 192456
Contract: Northgate Env. On Site Soils 3825 10
Comment: 3825 10 11244

Gross Weight: 124,020 LB Manual In
Tare Weight: 53,040 LB Manual Out
Net Weight: 70980 LB
Net Tons: 35.49

BOL: 11778

Origin	Yards	Material	Billing	Quantity
Not Applicable	0.00 YD	SW CONTAMINATED SOIL	35.49	TN

Driver: 

Weighmaster: 

IN - HOLDENS / OUT - CARTERJ

Indemnification. Customer agrees, by signature above, to indemnify, hold harmless, and defend Republic Services, Inc., its subsidiaries, affiliates, employees, officers and directors from and against any and all liabilities, claims, penalties, forfeitures, suits and the costs and expenses incident thereto, including costs of defense, settlement, and reasonable attorney's fees, which may be incurred, as a result of death or injuries to any person, or damage to any property, contamination of or adverse effects on the environment, caused in whole or in part by the Customer, its employees, or subcontractors in disposing waste at this Facility. In the event Customer delivers Unacceptable Waste (as determined by Republic) Customer agrees to assume all expenses and obligations with the removal and/or resolution of any effects caused by the delivery of such Unacceptable Waste.

Indemnización. Cliente acuerda indemnizar, mantener inmune, y defender Republic Services, Inc., sus subsidiarios, compañías, divisiones, empleados, oficiales y directores contra de cualquiera y de todas responsabilidades, demandas, penas, pérdidas, juicios, pleitos y los costos incidente además, incluyendo costos de defensa, de acuerdo judicial, y de honorarios razonables del abogado, que pueden ser incurridos en, o como resultado de, la muerte o herida personal a cualquier persona, o daños a cualquier característica, propiedad, contaminación de la tierra o efectos ilícitos en esta Facilidad, causado entero o en parte por el cliente, sus empleados, o sus subcontratistas en botar basura en esta Facilidad. En el caso que el Cliente entrega, bota, basura (según lo determinado por Republic) en este Establecimiento basura inaceptable en los reglamentos de este Establecimiento, el Cliente se compromete asumir todos los costos y obligaciones con el retiro y/o la resolución de cualquier dano(s) causado por la entrega de tal basura inaceptable.



NON-HAZARDOUS WASTE MANIFEST

MANIFEST # 11778

GENERATOR INFORMATION

Generator Name: Tronox LLC
Address: P.O. Box 55
City: Henderson County: Clark
State: NV Zip: 89009
Site Location (if different): 560 W. Lake Mead
Henderson, NV 89015 (702) 592-7727

CUSTOMER/BILLING INFORMATION

Billing Name: NGE LLC c/o Northgate Environment Management
Address: 300 Frank Ogawa Plaza, Ste 510
City: Oakland County: Alameda
State: CA Zip: 94612

Table with 5 columns: Republic Services Approval #, Description of Waste, Volume/Weight, Expiration Date, Container Type. Row 1: 38251011244, Soil for disposal, 35.49 TN, 12-31-2011, Tractor with Dump Trailer(s). Row 2: RZ- #

*Attach Additional Sheet if necessary

I hereby certify that the above-described materials are non-hazardous wastes as defined by 40 CFR-261 or any applicable state law. Further, that the above named materials are properly classified, described, packaged, marked and labeled, and are in proper condition for transportation according to the applicable regulations of the Department of Transportation.

Susan Crowley
Generator/Authorized Agent Name Signature Date Shipped

TRANSPORTER INFORMATION

Transporter Name: Las Vegas Paving DOT # 191949
Address: 4420 S. Decatur Truck Number: 192456
Las Vegas, NV 89103 Phone Number: (702) 353-4355

I certify no hazardous waste or other regulated substance was knowingly introduced to the waste while in my custody. The waste transported in this vehicle is the waste identified above, to the best of my knowledge.

Name of Authorized Agent Signature Date Delivered

DISPOSAL SITE INFORMATION

Site Name: Apex Regional Landfill Phone No. (702) 599-5920
Address: 13550 U.S. Hwy 93 Las Vegas, NV

I hereby acknowledge receipt of the above described materials

JASON CARTER
Name (Print or Type) Signature Date Received

81 Environmental Tech
13550 N Highway 93
Las Vegas, NV 89165

Ticket Type: INBOUND INVOICE

Ticket Number: 1681
Date: 10/04/2010
Time In: 9:33 pm
Time Out: 10:02 pm

Customer: 001011 - NGE, LLC c/o Northgate Environ Mgmt

Vehicle/Container: 192460
Contract: Northgate Env. On Site Soils 3825 11
Comment: 3825 10 11244

Gross Weight: 127,380 LB Manual In
Tare Weight: 53,380 LB Manual Out
Net Weight: 74000 LB
Net Tons: 37.00

BOL: 11779

Origin	Yards	Material	Billing	Quantity
Not Applicable	0.00 YD	SW CONTAMINATED SOIL	37.00	TN

Driver:

Arig Honish

Weighmaster:

Sei Duchi
IN - CARTERJ OUT - HOLDENS

Indemnification. Customer agrees, by signature above, to indemnify, hold harmless, and defend Republic Services, Inc., its subsidiaries, affiliates, employees, officers and directors from and against any and all liabilities, claims, penalties, forfeitures, suits and the costs and expenses incident thereto, including costs of defense, settlement, and reasonable attorney's fees, which may be incurred, as a result of death or injuries to any person, or damage to any property, contamination of or adverse effects on the environment, caused in whole or in part by the Customer, its employees, or subcontractors in disposing waste at this Facility. In the event Customer delivers Unacceptable Waste (as determined by Republic) Customer agrees to assume all expenses and obligations with the removal and/or resolution of any effects caused by the delivery of such Unacceptable Waste.

Indemnización. Cliente acuerda indemnizar, mantener inmune, y defender Republic Services, Inc., sus subsidiarios, compañías, divisiones, empleados, oficiales y directores contra de cualquiera y de todas responsabilidades, demandas, penas, pérdidas, juicios, pleitos y los costos incidente además, incluyendo costos de defensa, de acuerdo judicial, y de honorarios razonables del abogado, que pueden ser incurridos en, o como resultado de, la muerte o herida personal a cualquier persona, o daños a cualquier característica, propiedad, contaminación de la tierra o efectos ilícitos en esta Facilidad, causado entero o en parte por el cliente, sus empleados, o sus subcontratistas en botar basura en esta Facilidad. En el caso que el Cliente entrega, bota, basura (según lo determinado por Republic) en este Establecimiento basura inaceptable en los reglamentos de este Establecimiento, el Cliente se compromete asumir todos los costos y obligaciones con el retiro y/o la resolución de cualquier dano(s) causado por la entrega de tal basura inaceptable.



NON-HAZARDOUS WASTE MANIFEST

MANIFEST # 11779

GENERATOR INFORMATION

Generator Name: Tronox LLC
Address: P.O. Box 55
City: Henderson County: Clark
State: NV Zip: 89009
Site Location (if different): 560 W. Lake Mead
Henderson, NV 89015 (702) 592-7727

CUSTOMER/BILLING INFORMATION

Billing Name: NGE LLC c/o Northgate Environment Management
Address: 300 Frank Ogawa Plaza, Ste 510
City: Oakland County: Alameda
State: CA Zip: 94612

Table with 5 columns: Republic Services Approval #, Description of Waste, Volume/Weight, Expiration Date, Container Type. Row 1: 38251011244, Soil for disposal, 37.00 Ton, 12-31-2011, Tractor with Dump Trailer(s).

*Attach Additional Sheet if necessary

I hereby certify that the above-described materials are non-hazardous wastes as defined by 40 CFR 261 or any applicable state law. Further, that the above named materials are properly classified, described, packaged, marked and labeled, and are in proper condition for transportation according to the applicable regulations of the Department of Transportation.

Susan Crowley
Generator/Authorized Agent Name Signature Date Shipped

TRANSPORTER INFORMATION

Transporter Name: Las Vegas Paving DOT # 191949
Address: 4420 S. Decatur Truck Number: 2460
Las Vegas, NV 89103 Phone Number: (702) 353-4355

I certify no hazardous waste or other regulated substance was knowingly introduced to the waste while in my custody. The waste transported in this vehicle is the waste identified above, to the best of my knowledge.

Graig Honish
Name of Authorized Agent Signature Date Delivered 10-4-10

DISPOSAL SITE INFORMATION

Site Name: Apex Regional Landfill Phone No. (702) 599-5920
Address: 13550 U.S. Hwy 93 Las Vegas, NV

I hereby acknowledge receipt of the above described materials
Name (Print or Type) Signature Date Received 10/10/10

81 Environmental Tech
13550 N Highway 93
Las Vegas, NV 89165

Ticket Type: INBOUND INVOICE

Ticket Number: 1682
Date: 10/04/2010
Time In: 9:57 pm
Time Out: 10:18 pm

Customer: 001011 - NGE, LLC c/o Northgate Environ Mgmt

Vehicle/Container: 81494P
Contract: Northgate Env. On Site Soils 3825 1I
Comment: 3825 10 11244

Gross Weight: 125,060 LB Manual In
Tare Weight: 51,020 LB Manual Out
Net Weight: 74040 LB
Net Tons: 37.02

BOL: 11780

Origin	Yards	Material	Billing	Quantity
Not Applicable	0.00 YD	SW CONTAMINATED SOIL	37.02	TN

Driver: _____

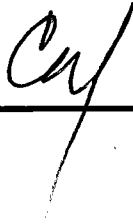

Weighmaster: _____

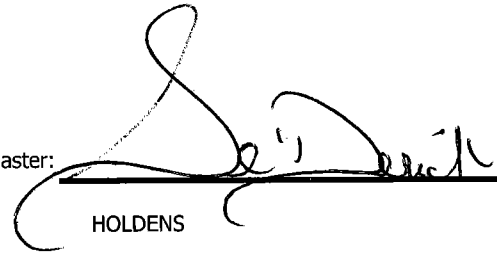

HOLDENS

Indemnification. Customer agrees, by signature above, to indemnify, hold harmless, and defend Republic Services, Inc., its subsidiaries, affiliates, employees, officers and directors from and against any and all liabilities, claims, penalties, forfeitures, suits and the costs and expenses incident thereto, including costs of defense, settlement, and reasonable attorney's fees, which may be incurred, as a result of death or injuries to any person, or damage to any property, contamination of or adverse effects on the environment, caused in whole or in part by the Customer, its employees, or subcontractors in disposing waste at this Facility. In the event Customer delivers Unacceptable Waste (as determined by Republic) Customer agrees to assume all expenses and obligations with the removal and/or resolution of any effects caused by the delivery of such Unacceptable Waste.

Indemnización. Cliente acuerda indemnizar, mantener inmune, y defender Republic Services, Inc., sus subsidiarios, compañías, divisiones, empleados, oficiales y directores contra de cualquiera y de todas responsabilidades, demandas, penas, pérdidas, juicios, pleitos y los costos incidente además, incluyendo costos de defensa, de acuerdo judicial, y de honorarios razonables del abogado, que pueden ser incurridos en, o como resultado de, la muerte o herida personal a cualquier persona, o daños a cualquier característica, propiedad, contaminación de la tierra o efectos ilícitos en esta Facilidad, causado entero o en parte por el cliente, sus empleados, o sus subcontratistas en botar basura en esta Facilidad. En el caso que el Cliente entrega, bota, basura (según lo determinado por Republic) en este Establecimiento basura inaceptable en los reglamentos de este Establecimiento, el Cliente se compromete asumir todos los costos y obligaciones con el retiro y/o la resolución de cualquier dano(s) causado por la entrega de tal basura inaceptable.



NON-HAZARDOUS WASTE MANIFEST

MANIFEST # 11780

GENERATOR INFORMATION

Generator Name: Tronox LLC

Address: P.O. Box 55

City: Henderson County: Clark

State: NV Zip: 89009

Site Location (if different): 560 W. Lake Mead

Henderson, NV 89015 (702) 592-7727

CUSTOMER/BILLING INFORMATION

Billing Name: NGE LLC c/o Northgate Environment Management

Address: 300 Frank Ogawa Plaza, Ste 510

City: Oakland County: Alameda

State: CA Zip: 94612

Republic Services Approval #	Description of Waste	Volume/Weight	Expiration Date	Container Type
38251011244	Soil for disposal	37 ⁰² _{ton}	12-31-2011	Tractor with Dump Trailer(s)
	RZ- _____ # _____			

*Attach Additional Sheet if necessary

I hereby certify that the above-described materials are non-hazardous wastes as defined by 40 CFR 261 or any applicable state law. Further, that the above named materials are properly classified, described, packaged, marked and labeled, and are in proper condition for transportation according to the applicable regulations of the Department of Transportation.

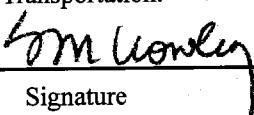
Susan Crowley 
 Generator/Authorized Agent Name Signature Date Shipped

TRANSPORTER INFORMATION

Transporter Name: Las Vegas Paving

DOT # 191949

Address: 4420 S. Decatur

Truck Number: 125

Las Vegas, NV 89103

Phone Number: (702) 353-4355

I certify no hazardous waste or other regulated substance was knowingly introduced to the waste while in my custody. The waste transported in this vehicle is the waste identified above, to the best of my knowledge.

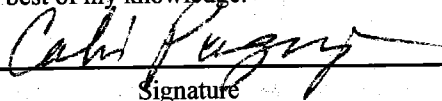
Calvin Puyyo 
 Name of Authorized Agent Signature Date Delivered 10-04-10

DISPOSAL SITE INFORMATION

Site Name: Apex Regional Landfill

Phone No. (702) 599-5920

Address: 13550 U.S. Hwy 93 Las Vegas, NV

I hereby acknowledge receipt of the above described materials

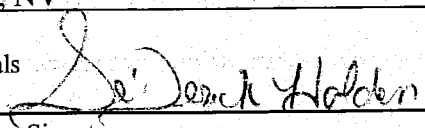
Holden, Se Derek 
 Name (Print or Type) Signature Date Received 04/04/10

81 Environmental Tech
13550 N Highway 93
Las Vegas, NV 89165

Ticket Type: INBOUND INVOICE

Ticket Number: 1683
Date: 10/04/2010
Time In: 10:12 pm
Time Out: 10:34 pm

Customer: 001011 - NGE, LLC c/o Northgate Environ Mgmt

Vehicle/Container: 81495P

Contract: Northgate Env. On Site Soils 3825 11
Comment: 3825 10 11244

Gross Weight: 130,960 LB Manual In
Tare Weight: 51,040 LB Manual Out
Net Weight: 79920 LB
Net Tons: 39.96

BOL: 11781

Origin	Yards	Material	Billing Quantity
Not Applicable	0.00 YD	SW CONTAMINATED SOIL	39.96 TN

Driver:

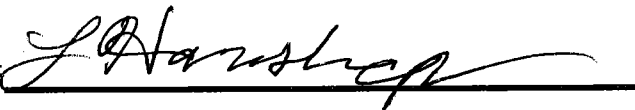

Weighmaster:



HOLDENS

Indemnification. Customer agrees, by signature above, to indemnify, hold harmless, and defend Republic Services, Inc., its subsidiaries, affiliates, employees, officers and directors from and against any and all liabilities, claims, penalties, forfeitures, suits and the costs and expenses incident thereto, including costs of defense, settlement, and reasonable attorney's fees, which may be incurred, as a result of death or injuries to any person, or damage to any property, contamination of or adverse effects on the environment, caused in whole or in part by the Customer, its employees, or subcontractors in disposing waste at this Facility. In the event Customer delivers Unacceptable Waste (as determined by Republic) Customer agrees to assume all expenses and obligations with the removal and/or resolution of any effects caused by the delivery of such Unacceptable Waste.

Indemnización. Cliente acuerda indemnizar, mantener inmune, y defender Republic Services, Inc., sus subsidiarios, compañías, divisiones, empleados, oficiales y directores contra de cualquiera y de todas responsabilidades, demandas, penas, pérdidas, juicios, pleitos y los costos incidente además, incluyendo costos de defensa, de acuerdo judicial, y de honorarios razonables del abogado, que pueden ser incurridos en, o como resultado de, la muerte o herida personal a cualquier persona, o daños a cualquier característica, propiedad, contaminación de la tierra o efectos ilícitos en esta Facilidad, causado entero o en parte por el cliente, sus empleados, o sus subcontratistas en botar basura en esta Facilidad. En el caso que el Cliente entrega, bota, basura (según lo determinado por Republic) en este Establecimiento basura inaceptable en los reglamentos de este Establecimiento, el Cliente se compromete asumir todos los costos y obligaciones con el retiro y/o la resolución de cualquier dano(s) causado por la entrega de tal basura inaceptable.



SR 40176

NON-HAZARDOUS WASTE MANIFEST

MANIFEST # 11781

GENERATOR INFORMATION

Generator Name: Tronox LLC
Address: P.O. Box 55
City: Henderson County: Clark
State: NV Zip: 89009
Site Location (if different): 560 W. Lake Mead
Henderson, NV 89015 (702) 592-7727

CUSTOMER/BILLING INFORMATION

Billing Name: NGE LLC c/o Northgate Environment Management
Address: 300 Frank Ogawa Plaza, Ste 510
City: Oakland County: Alameda
State: CA Zip: 94612

Table with 5 columns: Republic Services Approval #, Description of Waste, Volume/Weight, Expiration Date, Container Type. Row 1: 38251011244, Soil for disposal, 39 40/ton, 12-31-2011, Tractor with Dump Trailer(s).

*Attach Additional Sheet if necessary

I hereby certify that the above-described materials are non-hazardous wastes as defined by 40 CFR 261 or any applicable state law. Further, that the above named materials are properly classified, described, packaged, marked and labeled, and are in proper condition for transportation according to the applicable regulations of the Department of Transportation.

Susan Crowley
Generator/Authorized Agent Name Signature Date Shipped

TRANSPORTER INFORMATION

Transporter Name: Las Vegas Paving DOT # 191949
Address: 4420 S. Decatur Truck Number: 175
Las Vegas, NV 89103 Phone Number: (702) 353-4355

I certify no hazardous waste or other regulated substance was knowingly introduced to the waste while in my custody. The waste transported in this vehicle is the waste identified above, to the best of my knowledge.

Larry Harmsberger
Name of Authorized Agent Signature Date Delivered 10-4-10

DISPOSAL SITE INFORMATION

Site Name: Apex Regional Landfill Phone No. (702) 599-5920
Address: 13550 U.S. Hwy 93 Las Vegas, NV

I hereby acknowledge receipt of the above described materials
Name (Print or Type) Signature Date Received 04 Oct 10

81 Environmental Tech
13550 N Highway 93
Las Vegas, NV 89165

Ticket Type: INBOUND INVOICE

Ticket Number: 1684
Date: 10/04/2010
Time In: 10:13 pm
Time Out: 10:37 pm

Customer: 001011 - NGE, LLC c/o Northgate Environ Mgmt

Vehicle/Container: 81496P
Contract: Northgate Env. On Site Soils 3825 11
Comment: 3825 10 11244

Gross Weight: 127,600 LB Manual In
Tare Weight: 50,220 LB Manual Out
Net Weight: 77380 LB
Net Tons: 38.69

BOL: 11782

Origin	Yards	Material	Billing	Quantity
Not Applicable	0.00 YD	SW CONTAMINATED SOIL	38.69	TN

Driver: _____



Weighmaster: _____

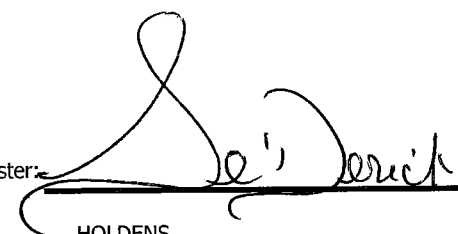

HOLDENS

Indemnification. Customer agrees, by signature above, to indemnify, hold harmless, and defend Republic Services, Inc., its subsidiaries, affiliates, employees, officers and directors from and against any and all liabilities, claims, penalties, forfeitures, suits and the costs and expenses incident thereto, including costs of defense, settlement, and reasonable attorney's fees, which may be incurred, as a result of death or injuries to any person, or damage to any property, contamination of or adverse effects on the environment, caused in whole or in part by the Customer, its employees, or subcontractors in disposing waste at this Facility. In the event Customer delivers Unacceptable Waste (as determined by Republic) Customer agrees to assume all expenses and obligations with the removal and/or resolution of any effects caused by the delivery of such Unacceptable Waste.

Indemnización. Cliente acuerda indemnizar, mantener inmune, y defender Republic Services, Inc., sus subsidiarios, compañías, divisiones, empleados, oficiales y directores contra de cualquiera y de todas responsabilidades, demandas, penas, pérdidas, juicios, pleitos y los costos incidente además, incluyendo costos de defensa, de acuerdo judicial, y de honorarios razonables del abogado, que pueden ser incurridos en, o como resultado de, la muerte o herida personal a cualquier persona, o daños a cualquier característica, propiedad, contaminación de la tierra o efectos ilícitos en esta Facilidad, causado entero o en parte por el cliente, sus empleados, o sus subcontratistas en botar basura en esta Facilidad. En el caso que el Cliente entrega, bota, basura (según lo determinado por Republic) en este Establecimiento basura inaceptable en los reglamentos de este Establecimiento, el Cliente se compromete asumir todos los costos y obligaciones con el retiro y/o la resolución de cualquier dano(s) causado por la entrega de tal basura inaceptable.



NON-HAZARDOUS WASTE MANIFEST

MANIFEST # 11782

GENERATOR INFORMATION

Generator Name: Tronox LLC
Address: P.O. Box 55
City: Henderson County: Clark
State: NV Zip: 89009
Site Location (if different): 560 W. Lake Mead
Henderson, NV 89015 (702) 592-7727

CUSTOMER/BILLING INFORMATION

Billing Name: NGE LLC c/o Northgate Environment Management
Address: 300 Frank Ogawa Plaza, Ste 510
City: Oakland County: Alameda
State: CA Zip: 94612

Table with 5 columns: Republic Services Approval #, Description of Waste, Volume/Weight, Expiration Date, Container Type. Row 1: 38251011244, Soil for disposal, 38 69/50, 12-31-2011, Tractor with Dump Trailer(s). Row 2: RZ- #

*Attach Additional Sheet if necessary

I hereby certify that the above-described materials are non-hazardous wastes as defined by 40 CFR 261 or any applicable state law. Further, that the above named materials are properly classified, described, packaged, marked and labeled, and are in proper condition for transportation according to the applicable regulations of the Department of Transportation.

Susan Crowley
Generator/Authorized Agent Name Signature Date Shipped

TRANSPORTER INFORMATION

Transporter Name: Las Vegas Paving DOT # 191949
Address: 4420 S. Decatur Truck Number: 145
Las Vegas, NV 89103 Phone Number: (702) 353-4355

I certify no hazardous waste or other regulated substance was knowingly introduced to the waste while in my custody. The waste transported in this vehicle is the waste identified above, to the best of my knowledge.

Henry McEul
Name of Authorized Agent Signature Date Delivered 10-4-10

DISPOSAL SITE INFORMATION

Site Name: Apex Regional Landfill Phone No. (702) 599-5920
Address: 13550 U.S. Hwy 93 Las Vegas, NV

I hereby acknowledge receipt of the above described materials
Name (Print or Type) Signature Date Received 04 Oct 10

81 Environmental Tech
13550 N Highway 93
Las Vegas, NV 89165

Ticket Type: INBOUND INVOICE

Ticket Number: 1685
Date: 10/04/2010
Time In: 10:20 pm
Time Out: 10:45 pm

Customer: 001011 - NGE, LLC c/o Northgate Environ Mgmt

Vehicle/Container: 81460P
Contract: Northgate Env. On Site Soils 3825 11
Comment: 3825 10 11244

Gross Weight: 129,880 LB Manual In
Tare Weight: 52,540 LB Manual Out
Net Weight: 77340 LB
Net Tons: 38.67

BOL: 11783

Origin	Yards	Material	Billing	Quantity
Not Applicable	0.00 YD	SW CONTAMINATED SOIL	38.67	TN

Driver: _____

Weighmaster: _____

HOLDENS

Indemnification. Customer agrees, by signature above, to indemnify, hold harmless, and defend Republic Services, Inc., its subsidiaries, affiliates, employees, officers and directors from and against any and all liabilities, claims, penalties, forfeitures, suits and the costs and expenses incident thereto, including costs of defense, settlement, and reasonable attorney's fees, which may be incurred, as a result of death or injuries to any person, or damage to any property, contamination of or adverse effects on the environment, caused in whole or in part by the Customer, its employees, or subcontractors in disposing waste at this Facility. In the event Customer delivers Unacceptable Waste (as determined by Republic) Customer agrees to assume all expenses and obligations with the removal and/or resolution of any effects caused by the delivery of such Unacceptable Waste.

Indemnización. Cliente acuerda indemnizar, mantener inmune, y defender Republic Services, Inc., sus subsidiarios, compañías, divisiones, empleados, oficiales y directores contra de cualquiera y de todas responsabilidades, demandas, penas, pérdidas, juicios, pleitos y los costos incidente además, incluyendo costos de defensa, de acuerdo judicial, y de honorarios razonables del abogado, que pueden ser incurridos en, o como resultado de, la muerte o herida personal a cualquier persona, o daños a cualquier característica, propiedad, contaminación de la tierra o efectos ilícitos en esta Facilidad, causado entero o en parte por el cliente, sus empleados, o sus subcontratistas en botar basura en esta Facilidad. En el caso que el Cliente entrega, bota, basura (según lo determinado por Republic) en este Establecimiento basura inaceptable en los reglamentos de este Establecimiento, el Cliente se compromete asumir todos los costos y obligaciones con el retiro y/o la resolución de cualquier dano(s) causado por la entrega de tal basura inaceptable.



NON-HAZARDOUS WASTE MANIFEST

MANIFEST # 11783

GENERATOR INFORMATION

Generator Name: Tronox LLC
Address: P.O. Box 55
City: Henderson County: Clark
State: NV Zip: 89009
Site Location (if different): 560 W. Lake Mead
Henderson, NV 89015 (702) 592-7727

CUSTOMER/BILLING INFORMATION

Billing Name: NGE LLC c/o Northgate Environment Management
Address: 300 Frank Ogawa Plaza, Ste 510
City: Oakland County: Alameda
State: CA Zip: 94612

Table with 5 columns: Republic Services Approval #, Description of Waste, Volume/Weight, Expiration Date, Container Type. Row 1: 38251011244, Soil for disposal, 38 67 ton, 12-31-2011, Tractor with Dump Trailer(s).

*Attach Additional Sheet if necessary

I hereby certify that the above-described materials are non-hazardous wastes as defined by 40 CFR 261 or any applicable state law. Further, that the above named materials are properly classified, described, packaged, marked and labeled, and are in proper condition for transportation according to the applicable regulations of the Department of Transportation.

Susan Crowley
Generator/Authorized Agent Name Signature Date Shipped

TRANSPORTER INFORMATION

Transporter Name: Las Vegas Paving DOT # 191949
Address: 4420 S. Decatur Truck Number: 27
Las Vegas, NV 89103 Phone Number: (702) 353-4355

I certify no hazardous waste or other regulated substance was knowingly introduced to the waste while in my custody. The waste transported in this vehicle is the waste identified above, to the best of my knowledge.

Daniel Cardenas
Name of Authorized Agent Signature Date Delivered 10-4-2010

DISPOSAL SITE INFORMATION

Site Name: Apex Regional Landfill Phone No. (702) 599-5920
Address: 13550 U.S. Hwy 93 Las Vegas, NV

I hereby acknowledge receipt of the above described materials
Hoblen Se'Derick
Name (Print or Type) Signature Date Received 04 Oct 10

81 Environmental Tech
13550 N Highway 93
Las Vegas, NV 89165

Ticket Type: INBOUND INVOICE

Ticket Number: 1686
Date: 10/04/2010
Time In: 10:25 pm
Time Out: 10:46 pm

Customer: 001011 - NGE, LLC c/o Northgate Environ Mgmt

Vehicle/Container: 84598P
Contract: Northgate Env. On Site Soils 3825 11
Comment: 3825 10 11244

Gross Weight: 130,420 LB Manual In
Tare Weight: 52,160 LB Manual Out
Net Weight: 78260 LB
Net Tons: 39.13

BOL: 11784

Origin	Yards	Material	Billing	Quantity
Not Applicable	0.00 YD	SW CONTAMINATED SOIL	39.13	TN

Driver:

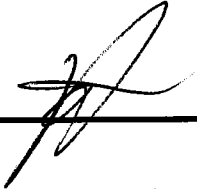

Weighmaster:

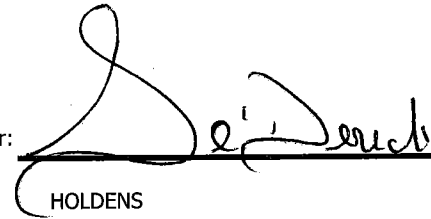
HOLDENS

Indemnification. Customer agrees, by signature above, to indemnify, hold harmless, and defend Republic Services, Inc., its subsidiaries, affiliates, employees, officers and directors from and against any and all liabilities, claims, penalties, forfeitures, suits and the costs and expenses incident thereto, including costs of defense, settlement, and reasonable attorney's fees, which may be incurred, as a result of death or injuries to any person, or damage to any property, contamination of or adverse effects on the environment, caused in whole or in part by the Customer, its employees, or subcontractors in disposing waste at this Facility. In the event Customer delivers Unacceptable Waste (as determined by Republic) Customer agrees to assume all expenses and obligations with the removal and/or resolution of any effects caused by the delivery of such Unacceptable Waste.

Indemnización. Cliente acuerda indemnizar, mantener inmune, y defender Republic Services, Inc., sus subsidiarios, compañías, divisiones, empleados, oficiales y directores contra de cualquiera y de todas responsabilidades, demandas, penas, pérdidas, juicios, pleitos y los costos incidente además, incluyendo costos de defensa, de acuerdo judicial, y de honorarios razonables del abogado, que pueden ser incurridos en, o como resultado de, la muerte o herida personal a cualquier persona, o daños a cualquier característica, propiedad, contaminación de la tierra o efectos ilícitos en esta Facilidad, causado entero o en parte por el cliente, sus empleados, o sus subcontratistas en botar basura en esta Facilidad. En el caso que el Cliente entrega, bota, basura (según lo determinado por Republic) en este Establecimiento basura inaceptable en los reglamentos de este Establecimiento, el Cliente se compromete asumir todos los costos y obligaciones con el retiro y/o la resolución de cualquier dano(s) causado por la entrega de tal basura inaceptable.



NON-HAZARDOUS WASTE MANIFEST

MANIFEST # 11784

GENERATOR INFORMATION

Generator Name: Tronox LLC

Address: P.O. Box 55

City: Henderson County: Clark

State: NV Zip: 89009

Site Location (if different): 560 W. Lake Mead

Henderson, NV 89015 (702) 592-7727

CUSTOMER/BILLING INFORMATION

Billing Name: NGE LLC c/o Northgate Environment Management

Address: 300 Frank Ogawa Plaza, Ste 510

City: Oakland County: Alameda

State: CA Zip: 94612

Republic Services Approval #	Description of Waste	Volume/Weight	Expiration Date	Container Type
38251011244	Soil for disposal	39 lbs	12-31-2011	Tractor with Dump Trailer(s)
	RZ- _____ # _____			

*Attach Additional Sheet if necessary

I hereby certify that the above-described materials are non-hazardous wastes as defined by 40 CFR 261 or any applicable state law. Further, that the above named materials are properly classified, described, packaged, marked and labeled, and are in proper condition for transportation according to the applicable regulations of the Department of Transportation.

Susan Crowley *S. Crowley*

Generator/Authorized Agent Name Signature Date Shipped

TRANSPORTER INFORMATION

Transporter Name: Las Vegas Paving

DOT # 191949

Address: 4420 S. Decatur

Truck Number: 28

Las Vegas, NV 89103

Phone Number: (702) 353-4355

I certify no hazardous waste or other regulated substance was knowingly introduced to the waste while in my custody. The waste transported in this vehicle is the waste identified above, to the best of my knowledge.

KANG *KANG* 10-4-10

Name of Authorized Agent Signature Date Delivered

DISPOSAL SITE INFORMATION

Site Name: Apex Regional Landfill

Phone No. (702) 599-5920

Address: 13550 U.S. Hwy 93 Las Vegas, NV

I hereby acknowledge receipt of the above described materials

DeDerick Holden

Name (Print or Type) Signature Date Received

81 Environmental Tech
13550 N Highway 93
Las Vegas, NV 89165

Ticket Type: INBOUND INVOICE

Ticket Number: 1687
Date: 10/04/2010
Time In: 10:27 pm
Time Out: 10:49 pm

Customer: 001011 - NGE, LLC c/o Northgate Environ Mgmt

Vehicle/Container: 76810P
Contract: Northgate Env. On Site Soils 3825 11
Comment: 3825 10 11244

Gross Weight: 131,420 LB Manual In
Tare Weight: 54,320 LB Manual Out
Net Weight: 77100 LB
Net Tons: 38.55

BOL: 11786

Origin	Yards	Material	Billing Quantity
Not Applicable	0.00 YD	SW CONTAMINATED SOIL	38.55 TN

Driver:

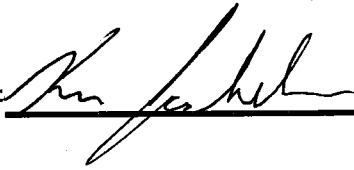

Weighmaster:

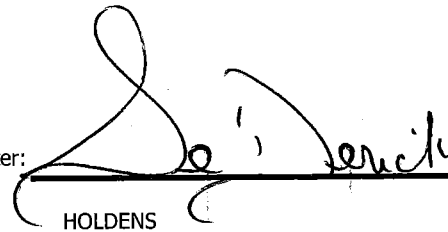
HOLDENS

Indemnification. Customer agrees, by signature above, to indemnify, hold harmless, and defend Republic Services, Inc., its subsidiaries, affiliates, employees, officers and directors from and against any and all liabilities, claims, penalties, forfeitures, suits and the costs and expenses incident thereto, including costs of defense, settlement, and reasonable attorney's fees, which may be incurred, as a result of death or injuries to any person, or damage to any property, contamination of or adverse effects on the environment, caused in whole or in part by the Customer, its employees, or subcontractors in disposing waste at this Facility. In the event Customer delivers Unacceptable Waste (as determined by Republic) Customer agrees to assume all expenses and obligations with the removal and/or resolution of any effects caused by the delivery of such Unacceptable Waste.

Indemnización. Cliente acuerda indemnizar, mantener inmune, y defender Republic Services, Inc., sus subsidiarios, compañías, divisiones, empleados, oficiales y directores contra de cualquiera y de todas responsabilidades, demandas, penas, pérdidas, juicios, pleitos y los costos incidente además, incluyendo costos de defensa, de acuerdo judicial, y de honorarios razonables del abogado, que pueden ser incurridos en, o como resultado de, la muerte o herida personal a cualquier persona, o daños a cualquier característica, propiedad, contaminación de la tierra o efectos ilícitos en esta Facilidad, causado entero o en parte por el cliente, sus empleados, o sus subcontratistas en botar basura en esta Facilidad. En el caso que el Cliente entrega, bota, basura (según lo determinado por Republic) en este Establecimiento basura inaceptable en los reglamentos de este Establecimiento, el Cliente se compromete asumir todos los costos y obligaciones con el retiro y/o la resolución de cualquier dano(s) causado por la entrega de tal basura inaceptable.



NON-HAZARDOUS WASTE MANIFEST

MANIFEST # 11786

GENERATOR INFORMATION

Generator Name: Tronox LLC
Address: P.O. Box 55
City: Henderson County: Clark
State: NV Zip: 89009
Site Location (if different): 560 W. Lake Mead
Henderson, NV 89015 (702) 592-7727

CUSTOMER/BILLING INFORMATION

Billing Name: NGE LLC c/o Northgate Environment Management
Address: 300 Frank Ogawa Plaza, Ste 510
City: Oakland County: Alameda
State: CA Zip: 94612

Table with 5 columns: Republic Services Approval #, Description of Waste, Volume/Weight, Expiration Date, Container Type. Row 1: 38251011244, Soil for disposal, 38 50/70n, 12-31-2011, Tractor with Dump Trailer(s). Row 2: RZ- #

*Attach Additional Sheet if necessary

I hereby certify that the above-described materials are non-hazardous wastes as defined by 40 CFR 261 or any applicable state law. Further, that the above named materials are properly classified, described, packaged, marked and labeled, and are in proper condition for transportation according to the applicable regulations of the Department of Transportation.

Susan Crowley (Signature)
Generator/Authorized Agent Name Signature Date Shipped

TRANSPORTER INFORMATION

Transporter Name: Las Vegas Paving DOT # 191949
Address: 4420 S. Decatur Truck Number: 241
Las Vegas, NV 89103 Phone Number: (702) 353-4355

I certify no hazardous waste or other regulated substance was knowingly introduced to the waste while in my custody. The waste transported in this vehicle is the waste identified above, to the best of my knowledge.

Ken Jacksta (Signature)
Name of Authorized Agent Signature Date Delivered 10-4-2010

DISPOSAL SITE INFORMATION

Site Name: Apex Regional Landfill Phone No. (702) 599-5920
Address: 13550 U.S. Hwy 93 Las Vegas, NV

I hereby acknowledge receipt of the above described materials

Holden Se' Derrick (Signature)
Name (Print or Type) Signature Date Received 04 Oct 10

81 Environmental Tech
13550 N Highway 93
Las Vegas, NV 89165

Ticket Type: INBOUND INVOICE

Ticket Number: 1688
Date: 10/04/2010
Time In: 10:30 pm
Time Out: 10:51 pm

Customer: 001011 - NGE, LLC c/o Northgate Environ Mgmt

Vehicle/Container: 82418P
Contract: Northgate Env. On Site Soils 3825 11
Comment: 3825 10 11244

Gross Weight: 140,260 LB Manual In
Tare Weight: 61,660 LB Manual Out
Net Weight: 78600 LB
Net Tons: 39.30

BOL: 11787

Origin	Yards	Material	Billing	Quantity
Not Applicable	0.00 YD	SW CONTAMINATED SOIL	39.30	TN

Driver: _____

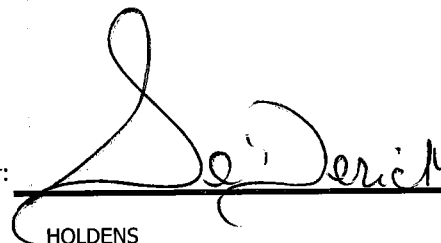

Weighmaster: _____

HOLDENS

Indemnification. Customer agrees, by signature above, to indemnify, hold harmless, and defend Republic Services, Inc., its subsidiaries, affiliates, employees, officers and directors from and against any and all liabilities, claims, penalties, forfeitures, suits and the costs and expenses incident thereto, including costs of defense, settlement, and reasonable attorney's fees, which may be incurred, as a result of death or injuries to any person, or damage to any property, contamination of or adverse effects on the environment, caused in whole or in part by the Customer, its employees, or subcontractors in disposing waste at this Facility. In the event Customer delivers Unacceptable Waste (as determined by Republic) Customer agrees to assume all expenses and obligations with the removal and/or resolution of any effects caused by the delivery of such Unacceptable Waste.

Indemnización. Cliente acuerda indemnizar, mantener inmune, y defender Republic Services, Inc., sus subsidiarios, compañías, divisiones, empleados, oficiales y directores contra de cualquiera y de todas responsabilidades, demandas, penas, pérdidas, juicios, pleitos y los costos incidente además, incluyendo costos de defensa, de acuerdo judicial, y de honorarios razonables del abogado, que pueden ser incurridos en, o como resultado de, la muerte o herida personal a cualquier persona, o daños a cualquier característica, propiedad, contaminación de la tierra o efectos ilícitos en esta Facilidad, causado entero o en parte por el cliente, sus empleados, o sus subcontratistas en botar basura en esta Facilidad. En el caso que el Cliente entrega, bota, basura (según lo determinado por Republic) en este Establecimiento basura inaceptable en los reglamentos de este Establecimiento, el Cliente se compromete asumir todos los costos y obligaciones con el retiro y/o la resolución de cualquier dano(s) causado por la entrega de tal basura inaceptable.



NON-HAZARDOUS WASTE MANIFEST

MANIFEST # 11787

GENERATOR INFORMATION

Generator Name: Tronox LLC
Address: P.O. Box 55
City: Henderson County: Clark
State: NV Zip: 89009
Site Location (if different): 560 W. Lake Mead
Henderson, NV 89015 (702) 592-7727

CUSTOMER/BILLING INFORMATION

Billing Name: NGE LLC c/o Northgate Environment Management
Address: 300 Frank Ogawa Plaza, Ste 510
City: Oakland County: Alameda
State: CA Zip: 94612

Table with 5 columns: Republic Services Approval #, Description of Waste, Volume/Weight, Expiration Date, Container Type. Row 1: 38251011244, Soil for disposal, 39-30 ton, 12-31-2011, Tractor with Dump Trailer(s).

*Attach Additional Sheet if necessary

I hereby certify that the above-described materials are non-hazardous wastes as defined by 40 CFR 261 or any applicable state law. Further, that the above named materials are properly classified, described, packaged, marked and labeled, and are in proper condition for transportation according to the applicable regulations of the Department of Transportation.

Susan Crowley (Signature)
Generator/Authorized Agent Name Signature Date Shipped

TRANSPORTER INFORMATION

Transporter Name: Las Vegas Paving DOT # 191949
Address: 4420 S. Decatur Truck Number: 220
Las Vegas, NV 89103 Phone Number: (702) 353-4355

I certify no hazardous waste or other regulated substance was knowingly introduced to the waste while in my custody. The waste transported in this vehicle is the waste identified above, to the best of my knowledge.

STEVE TAYLOR (Signature) 10-4-10
Name of Authorized Agent Signature Date Delivered

DISPOSAL SITE INFORMATION

Site Name: Apex Regional Landfill Phone No. (702) 599-5920
Address: 13550 U.S. Hwy 93 Las Vegas, NV

I hereby acknowledge receipt of the above described materials
Holden, Se/Derrick (Signature) 04 Oct 10
Name (Print or Type) Signature Date Received

81 Environmental Tech
13550 N Highway 93
Las Vegas, NV 89165

Ticket Type: INBOUND INVOICE

Ticket Number: 1689
Date: 10/04/2010
Time In: 10:30 pm
Time Out: 10:54 pm

Customer: 001011 - NGE, LLC c/o Northgate Environ Mgmt

Vehicle/Container: 44564A
Contract: Northgate Env. On Site Soils 3825 11
Comment: 3825 10 11244

Gross Weight: 125,720 LB Manual In
Tare Weight: 49,180 LB Manual Out
Net Weight: 76540 LB
Net Tons: 38.27

BOL: 11785

Origin	Yards	Material	Billing Quantity
Not Applicable	0.00 YD	SW CONTAMINATED SOIL	38.27 TN

Driver:

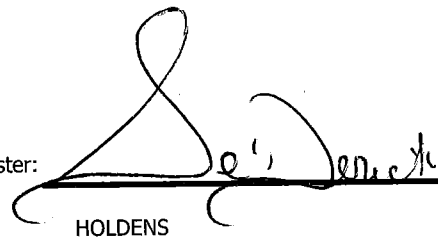

Weighmaster:

HOLDENS

Indemnification. Customer agrees, by signature above, to indemnify, hold harmless, and defend Republic Services, Inc., its subsidiaries, affiliates, employees, officers and directors from and against any and all liabilities, claims, penalties, forfeitures, suits and the costs and expenses incident thereto, including costs of defense, settlement, and reasonable attorney's fees, which may be incurred, as a result of death or injuries to any person, or damage to any property, contamination of or adverse effects on the environment, caused in whole or in part by the Customer, its employees, or subcontractors in disposing waste at this Facility. In the event Customer delivers Unacceptable Waste (as determined by Republic) Customer agrees to assume all expenses and obligations with the removal and/or resolution of any effects caused by the delivery of such Unacceptable Waste.

Indemnización. Cliente acuerda indemnizar, mantener inmune, y defender Republic Services, Inc., sus subsidiarios, compañías, divisiones, empleados, oficiales y directores contra de cualquiera y de todas responsabilidades, demandas, penas, pérdidas, juicios, pleitos y los costos incidente además, incluyendo costos de defensa, de acuerdo judicial, y de honorarios razonables del abogado, que pueden ser incurridos en, o como resultado de, la muerte o herida personal a cualquier persona, o daños a cualquier característica, propiedad, contaminación de la tierra o efectos ilícitos en esta Facilidad, causado entero o en parte por el cliente, sus empleados, o sus subcontratistas en botar basura en esta Facilidad. En el caso que el Cliente entrega, bota, basura (según lo determinado por Republic) en este Establecimiento basura inaceptable en los reglamentos de este Establecimiento, el Cliente se compromete asumir todos los costos y obligaciones con el retiro y/o la resolución de cualquier dano(s) causado por la entrega de tal basura inaceptable.



NON-HAZARDOUS WASTE MANIFEST

MANIFEST # 11785

GENERATOR INFORMATION

Generator Name: Tronox LLC
Address: P.O. Box 55
City: Henderson County: Clark
State: NV Zip: 89009
Site Location (if different): 560 W. Lake Mead
Henderson, NV 89015 (702) 592-7727

CUSTOMER/BILLING INFORMATION

Billing Name: NGE LLC c/o Northgate Environment Management
Address: 300 Frank Ogawa Plaza, Ste 510
City: Oakland County: Alameda
State: CA Zip: 94612

Table with 5 columns: Republic Services Approval #, Description of Waste, Volume/Weight, Expiration Date, Container Type. Row 1: 38251011244, Soil for disposal, 39 27 Ton, 12-31-2011, Tractor with Dump Trailer(s).

*Attach Additional Sheet if necessary

I hereby certify that the above-described materials are non-hazardous wastes as defined by 40 CFR 261 or any applicable state law. Further, that the above named materials are properly classified, described, packaged, marked and labeled, and are in proper condition for transportation according to the applicable regulations of the Department of Transportation.

Susan Crowley (Signature)
Generator/Authorized Agent Name Signature Date Shipped

TRANSPORTER INFORMATION

Transporter Name: Las Vegas Paving DOT # 191949
Address: 4420 S. Decatur Truck Number: K003
Las Vegas, NV 89103 Phone Number: (702) 353-4355

I certify no hazardous waste or other regulated substance was knowingly introduced to the waste while in my custody. The waste transported in this vehicle is the waste identified above, to the best of my knowledge.

Asencio (Signature) Miller (Signature) 10/09/10
Name of Authorized Agent Signature Date Delivered

DISPOSAL SITE INFORMATION

Site Name: Apex Regional Landfill Phone No. (702) 599-5920
Address: 13550 U.S. Hwy 93 Las Vegas, NV

I hereby acknowledge receipt of the above described materials
Halden, Se Derrick (Signature) 01 Oct 10
Name (Print or Type) Signature Date Received

81 Environmental Tech
13550 N Highway 93
Las Vegas, NV 89165

Ticket Type: INBOUND INVOICE

Ticket Number: 1690
Date: 10/04/2010
Time In: 10:35 pm
Time Out: 10:59 pm

Customer: 001011 - NGE, LLC c/o Northgate Environ Mgmt

Vehicle/Container: 86053P
Contract: Northgate Env. On Site Soils 3825 11
Comment: 3825 10 11244

Gross Weight: 129,360 LB Manual In
Tare Weight: 54,660 LB Manual Out
Net Weight: 74,700 LB
Net Tons: 37.35

BOL: 11788

Origin	Yards	Material	Billing	Quantity
Not Applicable	0.00 YD	SW CONTAMINATED SOIL	37.35	TN

Driver: _____

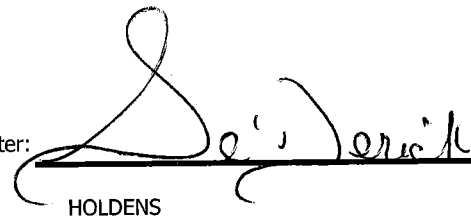

Weighmaster: _____

HOLDENS

Indemnification. Customer agrees, by signature above, to indemnify, hold harmless, and defend Republic Services, Inc., its subsidiaries, affiliates, employees, officers and directors from and against any and all liabilities, claims, penalties, forfeitures, suits and the costs and expenses incident thereto, including costs of defense, settlement, and reasonable attorney's fees, which may be incurred, as a result of death or injuries to any person, or damage to any property, contamination of or adverse effects on the environment, caused in whole or in part by the Customer, its employees, or subcontractors in disposing waste at this Facility. In the event Customer delivers Unacceptable Waste (as determined by Republic) Customer agrees to assume all expenses and obligations with the removal and/or resolution of any effects caused by the delivery of such Unacceptable Waste.

Indemnización. Cliente acuerda indemnizar, mantener inmune, y defender Republic Services, Inc., sus subsidiarios, compañías, divisiones, empleados, oficiales y directores contra de cualquiera y de todas responsabilidades, demandas, penas, pérdidas, juicios, pleitos y los costos incidente además, incluyendo costos de defensa, de acuerdo judicial, y de honorarios razonables del abogado, que pueden ser incurridos en, o como resultado de, la muerte o herida personal a cualquier persona, o daños a cualquier característica, propiedad, contaminación de la tierra o efectos ilícitos en esta Facilidad, causado entero o en parte por el cliente, sus empleados, o sus subcontratistas en botar basura en esta Facilidad. En el caso que el Cliente entrega, bota, basura (según lo determinado por Republic) en este Establecimiento basura inaceptable en los reglamentos de este Establecimiento, el Cliente se compromete asumir todos los costos y obligaciones con el retiro y/o la resolución de cualquier dano(s) causado por la entrega de tal basura inaceptable.



NON-HAZARDOUS WASTE MANIFEST

MANIFEST # 11788

GENERATOR INFORMATION

Generator Name: Tronox LLC

Address: P.O. Box 55

City: Henderson County: Clark

State: NV Zip: 89009

Site Location (if different): 560 W. Lake Mead

Henderson, NV 89015 (702) 592-7727

CUSTOMER/BILLING INFORMATION

Billing Name: NGE LLC c/o Northgate Environment Management

Address: 300 Frank Ogawa Plaza, Ste 510

City: Oakland County: Alameda

State: CA Zip: 94612

Republic Services Approval #	Description of Waste	Volume/Weight	Expiration Date	Container Type
38251011244	Soil for disposal	37 ³⁵ / _{ton}	12-31-2011	Tractor with Dump Trailer(s)
	RZ- #			

*Attach Additional Sheet if necessary

I hereby certify that the above-described materials are non-hazardous wastes as defined by 40 CFR 261 or any applicable state law. Further, that the above named materials are properly classified, described, packaged, marked and labeled, and are in proper condition for transportation according to the applicable regulations of the Department of Transportation.

Susan Crowley

Susan Crowley

Generator/Authorized Agent Name

Signature

Date Shipped

TRANSPORTER INFORMATION

Transporter Name: Las Vegas Paving

DOT # 191949

Address: 4420 S. Decatur

Truck Number: 261

Las Vegas, NV 89103

Phone Number: (702) 353-4355

I certify no hazardous waste or other regulated substance was knowingly introduced to the waste while in my custody. The waste transported in this vehicle is the waste identified above, to the best of my knowledge.

Patrick Jones

Name of Authorized Agent

Patrick Jones

Signature

4 OCT 10

Date Delivered

DISPOSAL SITE INFORMATION

Site Name: Apex Regional Landfill

Phone No. (702) 599-5920

Address: 13550 U.S. Hwy 93 Las Vegas, NV

I hereby acknowledge receipt of the above described materials

Holden, Se Derick

Se Derick Holden

Name (Print or Type)

Signature

04 Oct 10

Date Received

81 Environmental Tech
13550 N Highway 93
Las Vegas, NV 89165

Ticket Type: INBOUND INVOICE

Ticket Number: 1691
Date: 10/04/2010
Time In: 10:45 pm
Time Out: 11:08 pm

Customer: 001011 - NGE, LLC c/o Northgate Environ Mgmt

Vehicle/Container: 44165A
Contract: Northgate Env. On Site Soils 3825 11
Comment: 3825 10 11244

Gross Weight: 129,080 LB Manual In
Tare Weight: 48,640 LB Manual Out
Net Weight: 80440 LB
Net Tons: 40.22

BOL: 11789

Origin	Yards	Material	Billing Quantity
Not Applicable	0.00 YD	SW CONTAMINATED SOIL	40.22 TN

Driver:



Weighmaster:

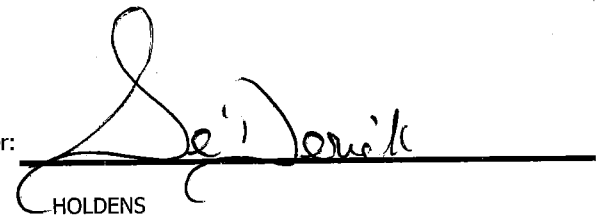

HOLDENS

Indemnification. Customer agrees, by signature above, to indemnify, hold harmless, and defend Republic Services, Inc., its subsidiaries, affiliates, employees, officers and directors from and against any and all liabilities, claims, penalties, forfeitures, suits and the costs and expenses incident thereto, including costs of defense, settlement, and reasonable attorney's fees, which may be incurred, as a result of death or injuries to any person, or damage to any property, contamination of or adverse effects on the environment, caused in whole or in part by the Customer, its employees, or subcontractors in disposing waste at this Facility. In the event Customer delivers Unacceptable Waste (as determined by Republic) Customer agrees to assume all expenses and obligations with the removal and/or resolution of any effects caused by the delivery of such Unacceptable Waste.

Indemnización. Cliente acuerda indemnizar, mantener inmune, y defender Republic Services, Inc., sus subsidiarios, compañías, divisiones, empleados, oficiales y directores contra de cualquiera y de todas responsabilidades, demandas, penas, pérdidas, juicios, pleitos y los costos incidente además, incluyendo costos de defensa, de acuerdo judicial, y de honorarios razonables del abogado, que pueden ser incurridos en, o como resultado de, la muerte o herida personal a cualquier persona, o daños a cualquier característica, propiedad, contaminación de la tierra o efectos ilícitos en esta Facilidad, causado entero o en parte por el cliente, sus empleados, o sus subcontratistas en botar basura en esta Facilidad. En el caso que el Cliente entrega, bota, basura (según lo determinado por Republic) en este Establecimiento basura inaceptable en los reglamentos de este Establecimiento, el Cliente se compromete asumir todos los costos y obligaciones con el retiro y/o la resolución de cualquier dano(s) causado por la entrega de tal basura inaceptable.



NON-HAZARDOUS WASTE MANIFEST

MANIFEST # 11789

GENERATOR INFORMATION

Generator Name: Tronox LLC
Address: P.O. Box 55
City: Henderson County: Clark
State: NV Zip: 89009
Site Location (if different): 560 W. Lake Mead
Henderson, NV 89015 (702) 592-7727

CUSTOMER/BILLING INFORMATION

Billing Name: NGE LLC c/o Northgate Environment Management
Address: 300 Frank Ogawa Plaza, Ste 510
City: Oakland County: Alameda
State: CA Zip: 94612

Table with 5 columns: Republic Services Approval #, Description of Waste, Volume/Weight, Expiration Date, Container Type. Row 1: 38251011244, Soil for disposal, 40 22/70n, 12-31-2011, Tractor with Dump Trailer(s)

*Attach Additional Sheet if necessary

I hereby certify that the above-described materials are non-hazardous wastes as defined by 40 CFR 261 or any applicable state law. Further, that the above named materials are properly classified, described, packaged, marked and labeled, and are in proper condition for transportation according to the applicable regulations of the Department of Transportation.

Susan Crowley
Generator/Authorized Agent Name Signature Date Shipped

TRANSPORTER INFORMATION

Transporter Name: Las Vegas Paving DOT # 191949
Address: 4420 S. Decatur Truck Number: K001
Las Vegas, NV 89103 Phone Number: (702) 353-4355

I certify no hazardous waste or other regulated substance was knowingly introduced to the waste while in my custody. The waste transported in this vehicle is the waste identified above, to the best of my knowledge.

ARELLANO
Name of Authorized Agent Signature Date Delivered 10/04/10

DISPOSAL SITE INFORMATION

Site Name: Apex Regional Landfill Phone No. (702) 599-5920
Address: 13550 U.S. Hwy 93 Las Vegas, NV

I hereby acknowledge receipt of the above described materials
Halden, Se'Derrick
Name (Print or Type) Signature Date Received 04 Oct 10

81 Environmental Tech
13550 N Highway 93
Las Vegas, NV 89165

Ticket Type: INBOUND INVOICE

Ticket Number: 1692
Date: 10/04/2010
Time In: 10:47 pm
Time Out: 11:10 pm

Customer: 001011 - NGE, LLC c/o Northgate Environ Mgmt

Vehicle/Container: 76811P
Contract: Northgate Env. On Site Soils 3825 11
Comment: 3825 10 11244

Gross Weight: 130,720 LB Manual In
Tare Weight: 52,860 LB Manual Out
Net Weight: 77860 LB
Net Tons: 38.93

BOL: 11790

Origin	Yards	Material	Billing Quantity
Not Applicable	0.00 YD	SW CONTAMINATED SOIL	38.93 TN

Driver:



Weighmaster:

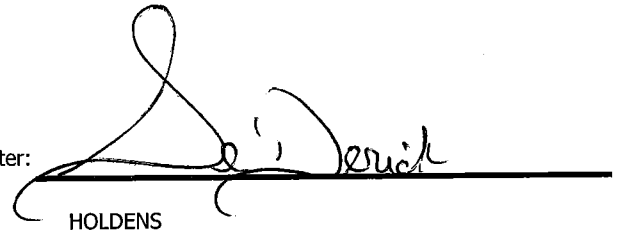

HOLDENS

Indemnification. Customer agrees, by signature above, to indemnify, hold harmless, and defend Republic Services, Inc., its subsidiaries, affiliates, employees, officers and directors from and against any and all liabilities, claims, penalties, forfeitures, suits and the costs and expenses incident thereto, including costs of defense, settlement, and reasonable attorney's fees, which may be incurred, as a result of death or injuries to any person, or damage to any property, contamination of or adverse effects on the environment, caused in whole or in part by the Customer, its employees, or subcontractors in disposing waste at this Facility. In the event Customer delivers Unacceptable Waste (as determined by Republic) Customer agrees to assume all expenses and obligations with the removal and/or resolution of any effects caused by the delivery of such Unacceptable Waste.

Indemnización. Cliente acuerda indemnizar, mantener inmune, y defender Republic Services, Inc., sus subsidiarios, compañías, divisiones, empleados, oficiales y directores contra de cualquiera y de todas responsabilidades, demandas, penas, pérdidas, juicios, pleitos y los costos incidente además, incluyendo costos de defensa, de acuerdo judicial, y de honorarios razonables del abogado, que pueden ser incurridos en, o como resultado de, la muerte o herida personal a cualquier persona, o daños a cualquier característica, propiedad, contaminación de la tierra o efectos ilícitos en esta Facilidad, causado entero o en parte por el cliente, sus empleados, o sus subcontratistas en botar basura en esta Facilidad. En el caso que el Cliente entrega, bota, basura (según lo determinado por Republic) en este Establecimiento basura inaceptable en los reglamentos de este Establecimiento, el Cliente se compromete asumir todos los costos y obligaciones con el retiro y/o la resolución de cualquier dano(s) causado por la entrega de tal basura inaceptable.



NON-HAZARDOUS WASTE MANIFEST

MANIFEST # 11790

GENERATOR INFORMATION

Generator Name: Tronox LLC

Address: P.O. Box 55

City: Henderson County: Clark

State: NV Zip: 89009

Site Location (if different): 560 W. Lake Mead

Henderson, NV 89015 (702) 592-7727

CUSTOMER/BILLING INFORMATION

Billing Name: NGE LLC c/o Northgate Environment Management

Address: 300 Frank Ogawa Plaza, Ste 510

City: Oakland County: Alameda

State: CA Zip: 94612

Republic Services Approval #	Description of Waste	Volume/Weight	Expiration Date	Container Type
38251011244	Soil for disposal	38 ⁹³ / ₁₀₁	12-31-2011	Tractor with Dump Trailer(s)
	RZ- #			

*Attach Additional Sheet if necessary

I hereby certify that the above-described materials are non-hazardous wastes as defined by 40 CFR 261 or any applicable state law. Further, that the above named materials are properly classified, described, packaged, marked and labeled, and are in proper condition for transportation according to the applicable regulations of the Department of Transportation.

Susan Crowley *Susan Crowley*

Generator/Authorized Agent Name Signature Date Shipped

TRANSPORTER INFORMATION

Transporter Name: Las Vegas Paving

DOT # 191949

Address: 4420 S. Decatur

Truck Number: 242

Las Vegas, NV 89103

Phone Number: (702) 353-4355

I certify no hazardous waste or other regulated substance was knowingly introduced to the waste while in my custody. The waste transported in this vehicle is the waste identified above, to the best of my knowledge.

STEVEN WAYES *Steven Wayes* 10-4-10

Name of Authorized Agent Signature Date Delivered

DISPOSAL SITE INFORMATION

Site Name: Apex Regional Landfill

Phone No. (702) 599-5920

Address: 13550 U.S. Hwy 93 Las Vegas, NV

I hereby acknowledge receipt of the above described materials

Holden, S. Derek *S. Derek Holden* 04 Oct 10

Name (Print or Type) Signature Date Received

81 Environmental Tech
13550 N Highway 93
Las Vegas, NV 89165

Ticket Type: INBOUND INVOICE

Ticket Number: 1693
Date: 10/04/2010
Time In: 10:54 pm
Time Out: 11:19 pm

Customer: 001011 - NGE, LLC c/o Northgate Environ Mgmt

Vehicle/Container: 68263P
Contract: Northgate Env. On Site Soils 3825 11
Comment: 3825 10 11244

Gross Weight: 129,720 LB Manual In
Tare Weight: 53,380 LB Manual Out
Net Weight: 76340 LB
Net Tons: 38.17

BOL: 11791

Origin	Yards	Material	Billing	Quantity
Not Applicable	0.00 YD	SW CONTAMINATED SOIL	38.17	TN

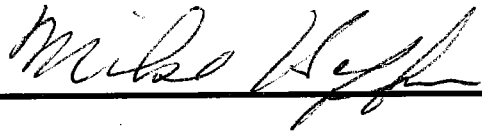
Driver: 

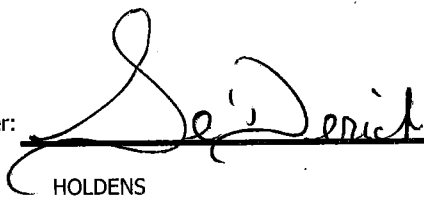
Weighmaster: 
HOLDENS

Indemnification. Customer agrees, by signature above, to indemnify, hold harmless, and defend Republic Services, Inc., its subsidiaries, affiliates, employees, officers and directors from and against any and all liabilities, claims, penalties, forfeitures, suits and the costs and expenses incident thereto, including costs of defense, settlement, and reasonable attorney's fees, which may be incurred, as a result of death or injuries to any person, or damage to any property, contamination of or adverse effects on the environment, caused in whole or in part by the Customer, its employees, or subcontractors in disposing waste at this Facility. In the event Customer delivers Unacceptable Waste (as determined by Republic) Customer agrees to assume all expenses and obligations with the removal and/or resolution of any effects caused by the delivery of such Unacceptable Waste.

Indemnización. Cliente acuerda indemnizar, mantener inmune, y defender Republic Services, Inc., sus subsidiarios, compañías, divisiones, empleados, oficiales y directores contra de cualquiera y de todas responsabilidades, demandas, penas, pérdidas, juicios, pleitos y los costos incidente además, incluyendo costos de defensa, de acuerdo judicial, y de honorarios razonables del abogado, que pueden ser incurridos en, o como resultado de, la muerte o herida personal a cualquier persona, o daños a cualquier característica, propiedad, contaminación de la tierra o efectos ilícitos en esta Facilidad, causado entero o en parte por el cliente, sus empleados, o sus subcontratistas en botar basura en esta Facilidad. En el caso que el Cliente entrega, bota, basura (según lo determinado por Republic) en este Establecimiento basura inaceptable en los reglamentos de este Establecimiento, el Cliente se compromete asumir todos los costos y obligaciones con el retiro y/o la resolución de cualquier dano(s) causado por la entrega de tal basura inaceptable.



NON-HAZARDOUS WASTE MANIFEST

MANIFEST # 11791

GENERATOR INFORMATION

Generator Name: Tronox LLC
Address: P.O. Box 55
City: Henderson County: Clark
State: NV Zip: 89009
Site Location (if different): 560 W. Lake Mead
Henderson, NV 89015 (702) 592-7727

CUSTOMER/BILLING INFORMATION

Billing Name: NGE LLC c/o Northgate Environment Management
Address: 300 Frank Ogawa Plaza, Ste 510
City: Oakland County: Alameda
State: CA Zip: 94612

Table with 5 columns: Republic Services Approval #, Description of Waste, Volume/Weight, Expiration Date, Container Type. Row 1: 38251011244, Soil for disposal, 38 17/100, 12-31-2011, Tractor with Dump Trailer(s).

*Attach Additional Sheet if necessary

I hereby certify that the above-described materials are non-hazardous wastes as defined by 40 CFR 261 or any applicable state law. Further, that the above named materials are properly classified, described, packaged, marked and labeled, and are in proper condition for transportation according to the applicable regulations of the Department of Transportation.

Susan Crowley (Signature)
Generator/Authorized Agent Name Signature Date Shipped

TRANSPORTER INFORMATION

Transporter Name: Las Vegas Paving DOT # 191949
Address: 4420 S. Decatur Truck Number: 2211
Las Vegas, NV 89103 Phone Number: (702) 353-4355

I certify no hazardous waste or other regulated substance was knowingly introduced to the waste while in my custody. The waste transported in this vehicle is the waste identified above, to the best of my knowledge.

Mike Haffern (Signature) Date Delivered: 10-4-10
Name of Authorized Agent Signature Date Delivered

DISPOSAL SITE INFORMATION

Site Name: Apex Regional Landfill Phone No. (702) 599-5920
Address: 13550 U.S. Hwy 93 Las Vegas, NV

I hereby acknowledge receipt of the above described materials
Holden, Seidman (Signature) Date Received: 04 Oct 10
Name (Print or Type) Signature Date Received

81 Environmental Tech
13550 N Highway 93
Las Vegas, NV 89165

Ticket Type: INBOUND INVOICE

Ticket Number: 1694
Date: 10/04/2010
Time In: 11:02 pm
Time Out: 11:24 pm

Customer: 001011 - NGE, LLC c/o Northgate Environ Mgmt

Vehicle/Container: 86113P
Contract: Northgate Env. On Site Soils 3825 11
Comment: 3825 10 11244

Gross Weight: 134,540 LB Manual In
Tare Weight: 55,500 LB Manual Out
Net Weight: 79040 LB
Net Tons: 39.52

BOL: 11792

Origin	Yards	Material	Billing	Quantity
Not Applicable	0.00 YD	SW CONTAMINATED SOIL	39.52	TN

Driver: _____

J. A. H.

Weighmaster: _____

Sei Derrick
HOLDENS

Indemnification. Customer agrees, by signature above, to indemnify, hold harmless, and defend Republic Services, Inc., its subsidiaries, affiliates, employees, officers and directors from and against any and all liabilities, claims, penalties, forfeitures, suits and the costs and expenses incident thereto, including costs of defense, settlement, and reasonable attorney's fees, which may be incurred, as a result of death or injuries to any person, or damage to any property, contamination of or adverse effects on the environment, caused in whole or in part by the Customer, its employees, or subcontractors in disposing waste at this Facility. In the event Customer delivers Unacceptable Waste (as determined by Republic) Customer agrees to assume all expenses and obligations with the removal and/or resolution of any effects caused by the delivery of such Unacceptable Waste.

Indemnización. Cliente acuerda indemnizar, mantener inmune, y defender Republic Services, Inc., sus subsidiarios, compañías, divisiones, empleados, oficiales y directores contra de cualquiera y de todas responsabilidades, demandas, penas, pérdidas, juicios, pleitos y los costos incidente además, incluyendo costos de defensa, de acuerdo judicial, y de honorarios razonables del abogado, que pueden ser incurridos en, o como resultado de, la muerte o herida personal a cualquier persona, o daños a cualquier característica, propiedad, contaminación de la tierra o efectos ilícitos en esta Facilidad, causado entero o en parte por el cliente, sus empleados, o sus subcontratistas en botar basura en esta Facilidad. En el caso que el Cliente entrega, bota, basura (según lo determinado por Republic) en este Establecimiento basura inaceptable en los reglamentos de este Establecimiento, el Cliente se compromete asumir todos los costos y obligaciones con el retiro y/o la resolución de cualquier dano(s) causado por la entrega de tal basura inaceptable.



NON-HAZARDOUS WASTE MANIFEST

MANIFEST # 11792

GENERATOR INFORMATION

Generator Name: Tronox LLC
Address: P.O. Box 55
City: Henderson County: Clark
State: NV Zip: 89009
Site Location (if different): 560 W. Lake Mead
Henderson, NV 89015 (702) 592-7727

CUSTOMER/BILLING INFORMATION

Billing Name: NGE LLC c/o Northgate Environment Management
Address: 300 Frank Ogawa Plaza, Ste 510
City: Oakland County: Alameda
State: CA Zip: 94612

Table with 5 columns: Republic Services Approval #, Description of Waste, Volume/Weight, Expiration Date, Container Type. Row 1: 38251011244, Soil for disposal, 39.52, 12-31-2011, Tractor with Dump Trailer(s).

*Attach Additional Sheet if necessary

I hereby certify that the above-described materials are non-hazardous wastes as defined by 40 CFR 261 or any applicable state law. Further, that the above named materials are properly classified, described, packaged, marked and labeled, and are in proper condition for transportation according to the applicable regulations of the Department of Transportation.

Susan Crowley (Signature)
Generator/Authorized Agent Name Signature Date Shipped

TRANSPORTER INFORMATION

Transporter Name: Las Vegas Paving DOT # 191949
Address: 4420 S. Decatur Truck Number: K0019/7
Las Vegas, NV 89103 Phone Number: (702) 353-4355

I certify no hazardous waste or other regulated substance was knowingly introduced to the waste while in my custody. The waste transported in this vehicle is the waste identified above, to the best of my knowledge.

ALBERTO HERRERA (Signature)
Name of Authorized Agent Signature Date Delivered Oct 4, 2010

DISPOSAL SITE INFORMATION

Site Name: Apex Regional Landfill Phone No. (702) 599-5920
Address: 13550 U.S. Hwy 93 Las Vegas, NV

I hereby acknowledge receipt of the above described materials
Holden, S. (Signature)
Name (Print or Type) Signature Date Received 04/Oct/10

81 Environmental Tech
13550 N Highway 93
Las Vegas, NV 89165

Ticket Type: INBOUND INVOICE

Ticket Number: 1695
Date: 10/04/2010
Time In: 11:06 pm
Time Out: 11:32 pm

Customer: 001011 - NGE, LLC c/o Northgate Environ Mgmt

Vehicle/Container: 44166A
Contract: Northgate Env. On Site Soils 3825 11
Comment: 3825 10 11244 1

Gross Weight: 136,980 LB Manual In
Tare Weight: 57,200 LB Manual Out
Net Weight: 79,780 LB
Net Tons: 39.89

BOL: 1 1793

Origin	Yards	Material	Billing	Quantity
Not Applicable	0.00 YD	SW CONTAMINATED SOIL	39.89	TN

Driver: _____

Weighmaster: _____

HOLDENS

Indemnification. Customer agrees, by signature above, to indemnify, hold harmless, and defend Republic Services, Inc., its subsidiaries, affiliates, employees, officers and directors from and against any and all liabilities, claims, penalties, forfeitures, suits and the costs and expenses incident thereto, including costs of defense, settlement, and reasonable attorney's fees, which may be incurred, as a result of death or injuries to any person, or damage to any property, contamination of or adverse effects on the environment, caused in whole or in part by the Customer, its employees, or subcontractors in disposing waste at this Facility. In the event Customer delivers Unacceptable Waste (as determined by Republic) Customer agrees to assume all expenses and obligations with the removal and/or resolution of any effects caused by the delivery of such Unacceptable Waste.

Indemnización. Cliente acuerda indemnizar, mantener inmune, y defender Republic Services, Inc., sus subsidiarios, compañías, divisiones, empleados, oficiales y directores contra de cualquiera y de todas responsabilidades, demandas, penas, pérdidas, juicios, pleitos y los costos incidente además, incluyendo costos de defensa, de acuerdo judicial, y de honorarios razonables del abogado, que pueden ser incurridos en, o como resultado de, la muerte o herida personal a cualquier persona, o daños a cualquier característica, propiedad, contaminación de la tierra o efectos ilícitos en esta Facilidad, causado entero o en parte por el cliente, sus empleados, o sus subcontratistas en botar basura en esta Facilidad. En el caso que el Cliente entrega, bota, basura (según lo determinado por Republic) en este Establecimiento basura inaceptable en los reglamentos de este Establecimiento, el Cliente se compromete asumir todos los costos y obligaciones con el retiro y/o la resolución de cualquier dano(s) causado por la entrega de tal basura inaceptable.



NON-HAZARDOUS WASTE MANIFEST

MANIFEST # 11793

GENERATOR INFORMATION

Generator Name: Tronox LLC
Address: P.O. Box 55
City: Henderson County: Clark
State: NV Zip: 89009
Site Location (if different): 560 W. Lake Mead
Henderson, NV 89015 (702) 592-7727

CUSTOMER/BILLING INFORMATION

Billing Name: NGE LLC c/o Northgate Environment Management
Address: 300 Frank Ogawa Plaza, Ste 510
City: Oakland County: Alameda
State: CA Zip: 94612

Table with 5 columns: Republic Services Approval #, Description of Waste, Volume/Weight, Expiration Date, Container Type. Row 1: 38251011244, Soil for disposal, 39 89/100, 12-31-2011, Tractor with Dump Trailer(s).

*Attach Additional Sheet if necessary

I hereby certify that the above-described materials are non-hazardous wastes as defined by 40 CFR 261 or any applicable state law. Further, that the above named materials are properly classified, described, packaged, marked and labeled, and are in proper condition for transportation according to the applicable regulations of the Department of Transportation.

Susan Crowley
Generator/Authorized Agent Name Signature Date Shipped

TRANSPORTER INFORMATION

Transporter Name: Las Vegas Paving DOT # 191949
Address: 4420 S. Decatur Truck Number: K002
Las Vegas, NV 89103 Phone Number: (702) 353-4355

I certify no hazardous waste or other regulated substance was knowingly introduced to the waste while in my custody. The waste transported in this vehicle is the waste identified above, to the best of my knowledge.

Hugo Costell
Name of Authorized Agent Signature Date Delivered 10-4-10

DISPOSAL SITE INFORMATION

Site Name: Apex Regional Landfill Phone No. (702) 599-5920
Address: 13550 U.S. Hwy 93 Las Vegas, NV

I hereby acknowledge receipt of the above described materials

Holden S. Jordan
Name (Print or Type) Signature Date Received 04 Oct 10

81 Environmental Tech
13550 N Highway 93
Las Vegas, NV 89165

Ticket Type: INBOUND INVOICE

Ticket Number: 1696
Date: 10/04/2010
Time In: 11:07 pm
Time Out: 11:42 pm

Customer: 001011 - NGE, LLC c/o Northgate Environ Mgmt

Vehicle/Container: 34330A
Contract: Northgate Env. On Site Soils 3825 11
Comment: 3825 10 11244

Gross Weight: 129,880 LB Manual In
Tare Weight: 52,900 LB Manual Out
Net Weight: 76980 LB
Net Tons: 38.49

BOL: 11794

Origin	Yards	Material	Billing	Quantity
Not Applicable	0.00 YD	SW CONTAMINATED SOIL	38.49	TN

Driver:

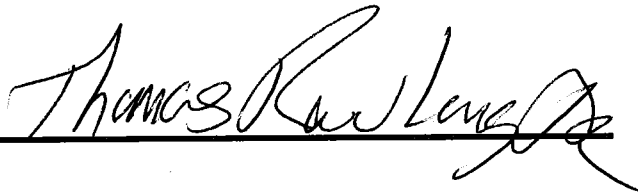

Weighmaster:

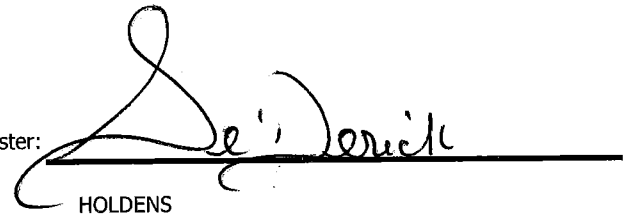

HOLDENS

Indemnification. Customer agrees, by signature above, to indemnify, hold harmless, and defend Republic Services, Inc., its subsidiaries, affiliates, employees, officers and directors from and against any and all liabilities, claims, penalties, forfeitures, suits and the costs and expenses incident thereto, including costs of defense, settlement, and reasonable attorney's fees, which may be incurred, as a result of death or injuries to any person, or damage to any property, contamination of or adverse effects on the environment, caused in whole or in part by the Customer, its employees, or subcontractors in disposing waste at this Facility. In the event Customer delivers Unacceptable Waste (as determined by Republic) Customer agrees to assume all expenses and obligations with the removal and/or resolution of any effects caused by the delivery of such Unacceptable Waste.

Indemnización. Cliente acuerda indemnizar, mantener inmune, y defender Republic Services, Inc., sus subsidiarios, compañías, divisiones, empleados, oficiales y directores contra de cualquiera y de todas responsabilidades, demandas, penas, pérdidas, juicios, pleitos y los costos incidente además, incluyendo costos de defensa, de acuerdo judicial, y de honorarios razonables del abogado, que pueden ser incurridos en, o como resultado de, la muerte o herida personal a cualquier persona, o daños a cualquier característica, propiedad, contaminación de la tierra o efectos ilícitos en esta Facilidad, causado entero o en parte por el cliente, sus empleados, o sus subcontratistas en botar basura en esta Facilidad. En el caso que el Cliente entrega, bota, basura (según lo determinado por Republic) en este Establecimiento basura inaceptable en los reglamentos de este Establecimiento, el Cliente se compromete asumir todos los costos y obligaciones con el retiro y/o la resolución de cualquier dano(s) causado por la entrega de tal basura inaceptable.



NON-HAZARDOUS WASTE MANIFEST

MANIFEST # 11794

GENERATOR INFORMATION

Generator Name: Tronox LLC
Address: P.O. Box 55
City: Henderson County: Clark
State: NV Zip: 89009
Site Location (if different): 560 W. Lake Mead
Henderson, NV 89015 (702) 592-7727

CUSTOMER/BILLING INFORMATION

Billing Name: NGE LLC c/o Northgate Environment Management
Address: 300 Frank Ogawa Plaza, Ste 510
City: Oakland County: Alameda
State: CA Zip: 94612

Table with 5 columns: Republic Services Approval #, Description of Waste, Volume/Weight, Expiration Date, Container Type. Row 1: 38251011244, Soil for disposal, 38 7/10 tons, 12-31-2011, Tractor with Dump Trailer(s).

*Attach Additional Sheet if necessary

I hereby certify that the above-described materials are non-hazardous wastes as defined by 40 CFR 261 or any applicable state law. Further, that the above named materials are properly classified, described, packaged, marked and labeled, and are in proper condition for transportation according to the applicable regulations of the Department of Transportation.

Susan Crowley
Generator/Authorized Agent Name Signature Date Shipped

TRANSPORTER INFORMATION

Transporter Name: Las Vegas Paving DOT # 191949
Address: 4420 S. Decatur Truck Number: 981
Las Vegas, NV 89103 Phone Number: (702) 353-4355

I certify no hazardous waste or other regulated substance was knowingly introduced to the waste while in my custody. The waste transported in this vehicle is the waste identified above, to the best of my knowledge.

Tom Kauling Jr. Signature Date Delivered 10-4-10
Name of Authorized Agent Signature Date Delivered

DISPOSAL SITE INFORMATION

Site Name: Apex Regional Landfill Phone No. (702) 599-5920
Address: 13550 U.S. Hwy 93 Las Vegas, NV

I hereby acknowledge receipt of the above described materials
Name (Print or Type) Signature Date Received 04 Oct 10

81 Environmental Tech
13550 N Highway 93
Las Vegas, NV 89165

Ticket Type: INBOUND INVOICE

Ticket Number: 1697
Date: 10/04/2010
Time In: 11:22 pm
Time Out: 11:50 pm

Customer: 001011 - NGE, LLC c/o Northgate Environ Mgmt

Vehicle/Container: 44164A
Contract: Northgate Env. On Site Soils 3825 11
Comment: 3825 10 11244

Gross Weight: 124,800 LB Manual In
Tare Weight: 55,740 LB Manual Out
Net Weight: 69060 LB
Net Tons: 34.53

BOL: 11795

Origin	Yards	Material	Billing	Quantity
Not Applicable	0.00 YD	SW CONTAMINATED SOIL	34.53	TN

Driver:

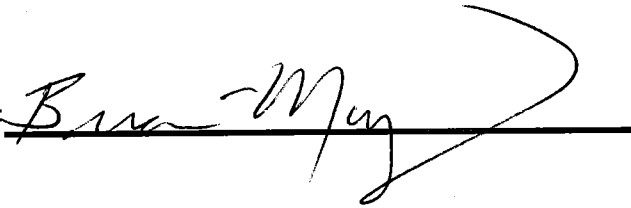

Weighmaster:

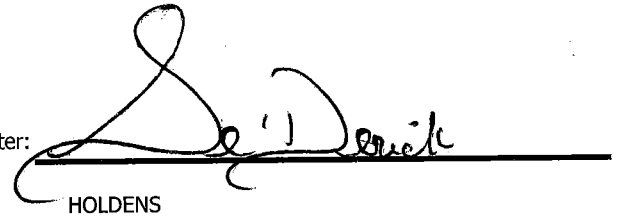

HOLDENS

Indemnification. Customer agrees, by signature above, to indemnify, hold harmless, and defend Republic Services, Inc., its subsidiaries, affiliates, employees, officers and directors from and against any and all liabilities, claims, penalties, forfeitures, suits and the costs and expenses incident thereto, including costs of defense, settlement, and reasonable attorney's fees, which may be incurred, as a result of death or injuries to any person, or damage to any property, contamination of or adverse effects on the environment, caused in whole or in part by the Customer, its employees, or subcontractors in disposing waste at this Facility. In the event Customer delivers Unacceptable Waste (as determined by Republic) Customer agrees to assume all expenses and obligations with the removal and/or resolution of any effects caused by the delivery of such Unacceptable Waste.

Indemnización. Cliente acuerda indemnizar, mantener inmune, y defender Republic Services, Inc., sus subsidiarios, compañías, divisiones, empleados, oficiales y directores contra de cualquiera y de todas responsabilidades, demandas, penas, pérdidas, juicios, pleitos y los costos incidente además, incluyendo costos de defensa, de acuerdo judicial, y de honorarios razonables del abogado, que pueden ser incurridos en, o como resultado de, la muerte o herida personal a cualquier persona, o daños a cualquier característica, propiedad, contaminación de la tierra o efectos ilícitos en esta Facilidad, causado entero o en parte por el cliente, sus empleados, o sus subcontratistas en botar basura en esta Facilidad. En el caso que el Cliente entrega, bota, basura (según lo determinado por Republic) en este Establecimiento basura inaceptable en los reglamentos de este Establecimiento, el Cliente se compromete asumir todos los costos y obligaciones con el retiro y/o la resolución de cualquier dano(s) causado por la entrega de tal basura inaceptable.



NON-HAZARDOUS WASTE MANIFEST

MANIFEST # 11795

GENERATOR INFORMATION

Generator Name: Tronox LLC
Address: P.O. Box 55
City: Henderson County: Clark
State: NV Zip: 89009
Site Location (if different): 560 W. Lake Mead
Henderson, NV 89015 (702) 592-7727

CUSTOMER/BILLING INFORMATION

Billing Name: NGE LLC c/o Northgate Environment Management
Address: 300 Frank Ogawa Plaza, Ste 510
City: Oakland County: Alameda
State: CA Zip: 94612

Table with 5 columns: Republic Services Approval #, Description of Waste, Volume/Weight, Expiration Date, Container Type. Row 1: 38251011244, Soil for disposal, 34 53/150, 12-31-2011, Tractor with Dump Trailer(s).

*Attach Additional Sheet if necessary

I hereby certify that the above-described materials are non-hazardous wastes as defined by 40 CFR 261 or any applicable state law. Further, that the above named materials are properly classified, described, packaged, marked and labeled, and are in proper condition for transportation according to the applicable regulations of the Department of Transportation.

Susan Crowley
Generator/Authorized Agent Name Signature Date Shipped

TRANSPORTER INFORMATION

Transporter Name: Las Vegas Paving DOT # 191949
Address: 4420 S. Decatur Truck Number: K-006
Las Vegas, NV 89103 Phone Number: (702) 353-4355

I certify no hazardous waste or other regulated substance was knowingly introduced to the waste while in my custody. The waste transported in this vehicle is the waste identified above, to the best of my knowledge.

Brian Malvey
Name of Authorized Agent Signature Date Delivered 10-4-10

DISPOSAL SITE INFORMATION

Site Name: Apex Regional Landfill Phone No. (702) 599-5920
Address: 13550 U.S. Hwy 93 Las Vegas, NV

I hereby acknowledge receipt of the above described materials
Holden, S. D. etc
Name (Print or Type) Signature Date Received 04 Oct 10

81 Environmental Tech
13550 N Highway 93
Las Vegas, NV 89165

Ticket Type: INBOUND INVOICE

Ticket Number: 1698
Date: 10/04/2010
Time In: 11:29 pm
Time Out: 11:55 pm

Customer: 001011 - NGE, LLC c/o Northgate Environ Mgmt

Vehicle/Container: 192457
Contract: Northgate Env. On Site Soils 3825 11
Comment: 3825 10 11244

Gross Weight: 130,620 LB Manual In
Tare Weight: 52,340 LB Manual Out
Net Weight: 78,280 LB
Net Tons: 39.14

BOL: 11796

Origin	Yards	Material	Billing	Quantity
Not Applicable	0.00 YD	SW CONTAMINATED SOIL	39.14	TN

Driver: 

Weighmaster: 

HOLDENS

Indemnification. Customer agrees, by signature above, to indemnify, hold harmless, and defend Republic Services, Inc., its subsidiaries, affiliates, employees, officers and directors from and against any and all liabilities, claims, penalties, forfeitures, suits and the costs and expenses incident thereto, including costs of defense, settlement, and reasonable attorney's fees, which may be incurred, as a result of death or injuries to any person, or damage to any property, contamination of or adverse effects on the environment, caused in whole or in part by the Customer, its employees, or subcontractors in disposing waste at this Facility. In the event Customer delivers Unacceptable Waste (as determined by Republic) Customer agrees to assume all expenses and obligations with the removal and/or resolution of any effects caused by the delivery of such Unacceptable Waste.

Indemnización. Cliente acuerda indemnizar, mantener inmune, y defender Republic Services, Inc., sus subsidiarios, compañías, divisiones, empleados, oficiales y directores contra de cualquiera y de todas responsabilidades, demandas, penas, pérdidas, juicios, pleitos y los costos incidente además, incluyendo costos de defensa, de acuerdo judicial, y de honorarios razonables del abogado, que pueden ser incurridos en, o como resultado de, la muerte o herida personal a cualquier persona, o daños a cualquier característica, propiedad, contaminación de la tierra o efectos ilícitos en esta Facilidad, causado entero o en parte por el cliente, sus empleados, o sus subcontratistas en botar basura en esta Facilidad. En el caso que el Cliente entrega, bota, basura (según lo determinado por Republic) en este Establecimiento basura inaceptable en los reglamentos de este Establecimiento, el Cliente se compromete asumir todos los costos y obligaciones con el retiro y/o la resolución de cualquier dano(s) causado por la entrega de tal basura inaceptable.



NON-HAZARDOUS WASTE MANIFEST

MANIFEST # 11796

GENERATOR INFORMATION

Generator Name: Tronox LLC
Address: P.O. Box 55
City: Henderson County: Clark
State: NV Zip: 89009
Site Location (if different): 560 W. Lake Mead
Henderson, NV 89015 (702) 592-7727

CUSTOMER/BILLING INFORMATION

Billing Name: NGE LLC c/o Northgate Environment Management
Address: 300 Frank Ogawa Plaza, Ste 510
City: Oakland County: Alameda
State: CA Zip: 94612

Table with 5 columns: Republic Services Approval #, Description of Waste, Volume/Weight, Expiration Date, Container Type. Row 1: 38251011244, Soil for disposal, 39 1/4 ton, 12-31-2011, Tractor with Dump Trailer(s).

*Attach Additional Sheet if necessary

I hereby certify that the above-described materials are non-hazardous wastes as defined by 40 CFR 261 or any applicable state law. Further, that the above named materials are properly classified, described, packaged, marked and labeled, and are in proper condition for transportation according to the applicable regulations of the Department of Transportation.

Susan Crowley
Generator/Authorized Agent Name Signature Date Shipped

TRANSPORTER INFORMATION

Transporter Name: Las Vegas Paving DOT # 191949
Address: 4420 S. Decatur Truck Number: 192457
Las Vegas, NV 89103 Phone Number: (702) 353-4355

I certify no hazardous waste or other regulated substance was knowingly introduced to the waste while in my custody. The waste transported in this vehicle is the waste identified above, to the best of my knowledge.

Brian Brinkelhoff
Name of Authorized Agent Signature Date Delivered 10-21-10

DISPOSAL SITE INFORMATION

Site Name: Apex Regional Landfill Phone No. (702) 599-5920
Address: 13550 U.S. Hwy 93 Las Vegas, NV

I hereby acknowledge receipt of the above described materials
Holden, Derrick
Name (Print or Type) Signature Date Received 04 Oct 10

81 Environmental Tech
13550 N Highway 93
Las Vegas, NV 89165

Ticket Type: INBOUND INVOICE

Ticket Number: 1699
Date: 10/04/2010
Time In: 11:35 pm
Time Out: 12:00 am

Customer: 001011 - NGE, LLC c/o Northgate Environ Mgmt

Vehicle/Container: 192456
Contract: Northgate Env. On Site Soils 3825 11
Comment: 3825 10 11244

Gross Weight: 127,040 LB Manual In
Tare Weight: 52,840 LB Manual Out
Net Weight: 74200 LB
Net Tons: 37.10

BOL: 11797

Origin	Yards	Material	Billing Quantity
Not Applicable	0.00 YD	SW CONTAMINATED SOIL	37.10 TN

Driver: 

Weighmaster: 

HOLDENS

Indemnification. Customer agrees, by signature above, to indemnify, hold harmless, and defend Republic Services, Inc., its subsidiaries, affiliates, employees, officers and directors from and against any and all liabilities, claims, penalties, forfeitures, suits and the costs and expenses incident thereto, including costs of defense, settlement, and reasonable attorney's fees, which may be incurred, as a result of death or injuries to any person, or damage to any property, contamination of or adverse effects on the environment, caused in whole or in part by the Customer, its employees, or subcontractors in disposing waste at this Facility. In the event Customer delivers Unacceptable Waste (as determined by Republic) Customer agrees to assume all expenses and obligations with the removal and/or resolution of any effects caused by the delivery of such Unacceptable Waste.

Indemnización. Cliente acuerda indemnizar, mantener inmune, y defender Republic Services, Inc., sus subsidiarios, compañías, divisiones, empleados, oficiales y directores contra de cualquiera y de todas responsabilidades, demandas, penas, pérdidas, juicios, pleitos y los costos incidente además, incluyendo costos de defensa, de acuerdo judicial, y de honorarios razonables del abogado, que pueden ser incurridos en, o como resultado de, la muerte o herida personal a cualquier persona, o daños a cualquier característica, propiedad, contaminación de la tierra o efectos ilícitos en esta Facilidad, causado entero o en parte por el cliente, sus empleados, o sus subcontratistas en botar basura en esta Facilidad. En el caso que el Cliente entrega, bota, basura (según lo determinado por Republic) en este Establecimiento basura inaceptable en los reglamentos de este Establecimiento, el Cliente se compromete asumir todos los costos y obligaciones con el retiro y/o la resolución de cualquier dano(s) causado por la entrega de tal basura inaceptable.



NON-HAZARDOUS WASTE MANIFEST

MANIFEST # 11797

GENERATOR INFORMATION

Generator Name: Tronox LLC

Address: P.O. Box 55

City: Henderson County: Clark

State: NV Zip: 89009

Site Location (if different): 560 W. Lake Mead
Henderson, NV 89015 (702) 592-7727

CUSTOMER/BILLING INFORMATION

Billing Name: NGE LLC c/o Northgate Environment Management

Address: 300 Frank Ogawa Plaza, Ste 510

City: Oakland County: Alameda

State: CA Zip: 94612

Republic Services Approval #	Description of Waste	Volume/Weight	Expiration Date	Container Type
38251011244	Soil for disposal	37 ⁷⁰ / _{ton}	12-31-2011	Tractor with Dump Trailer(s)
	RZ- _____ # _____			

*Attach Additional Sheet if necessary

I hereby certify that the above-described materials are non-hazardous wastes as defined by 40 CFR 261 or any applicable state law. Further, that the above named materials are properly classified, described, packaged, marked and labeled, and are in proper condition for transportation according to the applicable regulations of the Department of Transportation.

Susan Crowley *Tom Crowley*
 Generator/Authorized Agent Name Signature Date Shipped

TRANSPORTER INFORMATION

Transporter Name: Las Vegas Paving

DOT # 191949

Address: 4420 S. Decatur

Truck Number: 192456

Las Vegas, NV 89103

Phone Number: (702) 353-4355

I certify no hazardous waste or other regulated substance was knowingly introduced to the waste while in my custody. The waste transported in this vehicle is the waste identified above, to the best of my knowledge.

Blee *[Signature]* 10/4/10
 Name of Authorized Agent Signature Date Delivered

DISPOSAL SITE INFORMATION

Site Name: Apex Regional Landfill

Phone No. (702) 599-5920

Address: 13550 U.S. Hwy 93 Las Vegas, NV

I hereby acknowledge receipt of the above described materials
Holder, Se'Daniel *Se'Daniel Holder* 04 Oct 10
 Name (Print or Type) Signature Date Received

81 Environmental Tech
13550 N Highway 93
Las Vegas, NV 89165

Ticket Type: INBOUND INVOICE

Ticket Number: 1700
Date: 10/04/2010
Time In: 11:39 pm
Time Out: 12:07 am

Customer: 001011 - NGE, LLC c/o Northgate Environ Mgmt

Vehicle/Container: 192460
Contract: Northgate Env. On Site Soils 3825 11
Comment: 3825 10 11244

Gross Weight: 129,500 LB Manual In
Tare Weight: 53,220 LB Manual Out
Net Weight: 76280 LB
Net Tons: 38.14

BOL: 11798

Origin	Yards	Material	Billing	Quantity
Not Applicable	0.00 YD	SW CONTAMINATED SOIL	38.14	TN

Driver:

David Honish

Weighmaster:

Se' Denis
HOLDENS

Indemnification. Customer agrees, by signature above, to indemnify, hold harmless, and defend Republic Services, Inc., its subsidiaries, affiliates, employees, officers and directors from and against any and all liabilities, claims, penalties, forfeitures, suits and the costs and expenses incident thereto, including costs of defense, settlement, and reasonable attorney's fees, which may be incurred, as a result of death or injuries to any person, or damage to any property, contamination of or adverse effects on the environment, caused in whole or in part by the Customer, its employees, or subcontractors in disposing waste at this Facility. In the event Customer delivers Unacceptable Waste (as determined by Republic) Customer agrees to assume all expenses and obligations with the removal and/or resolution of any effects caused by the delivery of such Unacceptable Waste.

Indemnización. Cliente acuerda indemnizar, mantener inmune, y defender Republic Services, Inc., sus subsidiarios, compañías, divisiones, empleados, oficiales y directores contra de cualquiera y de todas responsabilidades, demandas, penas, pérdidas, juicios, pleitos y los costos incidente además, incluyendo costos de defensa, de acuerdo judicial, y de honorarios razonables del abogado, que pueden ser incurridos en, o como resultado de, la muerte o herida personal a cualquier persona, o daños a cualquier característica, propiedad, contaminación de la tierra o efectos ilícitos en esta Facilidad, causado entero o en parte por el cliente, sus empleados, o sus subcontratistas en botar basura en esta Facilidad. En el caso que el Cliente entrega, bota, basura (según lo determinado por Republic) en este Establecimiento basura inaceptable en los reglamentos de este Establecimiento, el Cliente se compromete asumir todos los costos y obligaciones con el retiro y/o la resolución de cualquier dano(s) causado por la entrega de tal basura inaceptable.



NON-HAZARDOUS WASTE MANIFEST

MANIFEST # 11798

GENERATOR INFORMATION

Generator Name: Tronox LLC
Address: P.O. Box 55
City: Henderson County: Clark
State: NV Zip: 89009
Site Location (if different): 560 W. Lake Mead
Henderson, NV 89015 (702) 592-7727

CUSTOMER/BILLING INFORMATION

Billing Name: NGE LLC c/o Northgate Environment Management
Address: 300 Frank Ogawa Plaza, Ste 510
City: Oakland County: Alameda
State: CA Zip: 94612

Table with 5 columns: Republic Services Approval #, Description of Waste, Volume/Weight, Expiration Date, Container Type. Row 1: 38251011244, Soil for disposal, 38 1/2 tons, 12-31-2011, Tractor with Dump Trailer(s).

*Attach Additional Sheet if necessary

I hereby certify that the above-described materials are non-hazardous wastes as defined by 40 CFR 261 or any applicable state law. Further, that the above named materials are properly classified, described, packaged, marked and labeled, and are in proper condition for transportation according to the applicable regulations of the Department of Transportation.

Susan Crowley (Signature)
Generator/Authorized Agent Name Signature Date Shipped

TRANSPORTER INFORMATION

Transporter Name: Las Vegas Paving DOT # 191949
Address: 4420 S. Decatur Truck Number: 2460
Las Vegas, NV 89103 Phone Number: (702) 353-4355

I certify no hazardous waste or other regulated substance was knowingly introduced to the waste while in my custody. The waste transported in this vehicle is the waste identified above, to the best of my knowledge.

Graig Honish (Signature)
Name of Authorized Agent Signature Date Delivered 10-4-10

DISPOSAL SITE INFORMATION

Site Name: Apex Regional Landfill Phone No. (702) 599-5920
Address: 13550 U.S. Hwy 93 Las Vegas, NV

I hereby acknowledge receipt of the above described materials
Name (Print or Type) Signature Date Received 04 Oct 10

81 Environmental Tech
13550 N Highway 93
Las Vegas, NV 89165

Ticket Type: INBOUND INVOICE

Ticket Number: 1701
Date: 10/04/2010
Time In: 11:53 pm
Time Out: 12:13 am

Customer: 001011 - NGE, LLC c/o Northgate Environ Mgmt

Vehicle/Container: 81494P
Contract: Northgate Env. On Site Soils 3825 11
Comment: 3825 10 11244

Gross Weight: 123,240 LB Manual In
Tare Weight: 51,020 LB Manual Out
Net Weight: 72220 LB
Net Tons: 36.11

BOL: 11799

Origin	Yards	Material	Billing	Quantity
Not Applicable	0.00 YD	SW CONTAMINATED SOIL	36.11	TN

Driver: _____

Weighmaster: _____

HOLDENS

Indemnification. Customer agrees, by signature above, to indemnify, hold harmless, and defend Republic Services, Inc., its subsidiaries, affiliates, employees, officers and directors from and against any and all liabilities, claims, penalties, forfeitures, suits and the costs and expenses incident thereto, including costs of defense, settlement, and reasonable attorney's fees, which may be incurred, as a result of death or injuries to any person, or damage to any property, contamination of or adverse effects on the environment, caused in whole or in part by the Customer, its employees, or subcontractors in disposing waste at this Facility. In the event Customer delivers Unacceptable Waste (as determined by Republic) Customer agrees to assume all expenses and obligations with the removal and/or resolution of any effects caused by the delivery of such Unacceptable Waste.

Indemnización. Cliente acuerda indemnizar, mantener inmune, y defender Republic Services, Inc., sus subsidiarios, compañías, divisiones, empleados, oficiales y directores contra de cualquiera y de todas responsabilidades, demandas, penas, pérdidas, juicios, pleitos y los costos incidente además, incluyendo costos de defensa, de acuerdo judicial, y de honorarios razonables del abogado, que pueden ser incurridos en, o como resultado de, la muerte o herida personal a cualquier persona, o daños a cualquier característica, propiedad, contaminación de la tierra o efectos ilícitos en esta Facilidad. En el caso que el Cliente entrega, bota, basura (según lo determinado por Republic) en este Establecimiento basura inaceptable en los reglamentos de este Establecimiento, el Cliente se compromete asumir todos los costos y obligaciones con el retiro y/o la resolución de cualquier dano(s) causado por la entrega de tal basura inaceptable.



NON-HAZARDOUS WASTE MANIFEST

MANIFEST # 11799

GENERATOR INFORMATION

Generator Name: Tronox LLC

Address: P.O. Box 55

City: Henderson County: Clark

State: NV Zip: 89009

Site Location (if different): 560 W. Lake Mead

Henderson, NV 89015 (702) 592-7727

CUSTOMER/BILLING INFORMATION

Billing Name: NGE LLC c/o Northgate Environment Management

Address: 300 Frank Ogawa Plaza, Ste 510

City: Oakland County: Alameda

State: CA Zip: 94612

Republic Services Approval #	Description of Waste	Volume/Weight	Expiration Date	Container Type
38251011244	Soil for disposal	36 ¹¹ / _{ton}	12-31-2011	Tractor with Dump Trailer(s)
	RZ- _____ # _____			

*Attach Additional Sheet if necessary

I hereby certify that the above-described materials are non-hazardous wastes as defined by 40 CFR 261 or any applicable state law. Further, that the above named materials are properly classified, described, packaged, marked and labeled, and are in proper condition for transportation according to the applicable regulations of the Department of Transportation.

Susan Crowley (Signature) Generator/Authorized Agent Name Date Shipped

TRANSPORTER INFORMATION

Transporter Name: Las Vegas Paving

DOT # 191949

Address: 4420 S. Decatur

Truck Number: 125

Las Vegas, NV 89103

Phone Number: (702) 353-4355

I certify no hazardous waste or other regulated substance was knowingly introduced to the waste while in my custody. The waste transported in this vehicle is the waste identified above, to the best of my knowledge.

Calvin Paguyo (Signature) Name of Authorized Agent Date Delivered 10-04-10

DISPOSAL SITE INFORMATION

Site Name: Apex Regional Landfill

Phone No. (702) 599-5920

Address: 13550 U.S. Hwy 93 Las Vegas, NV

I hereby acknowledge receipt of the above described materials

Holden, Se' Derrick (Signature) Name (Print or Type) Date Received 04 Oct 10

81 Environmental Tech
13550 N Highway 93
Las Vegas, NV 89165

Ticket Type: INBOUND INVOICE

Ticket Number: 1702
Date: 10/05/2010
Time In: 12:13 am
Time Out: 12:35 am

Customer: 001011 - NGE, LLC c/o Northgate Environ Mgmt

Vehicle/Container: 81495P
Contract: Northgate Env. On Site Soils 3825 11
Comment: 3825 10 11244

Gross Weight: 127,880 LB Manual In
Tare Weight: 51,040 LB Manual Out
Net Weight: 76840 LB
Net Tons: 38.42

BOL: 11800

Origin	Yards	Material	Billing Quantity
Not Applicable	0.00 YD	SW CONTAMINATED SOIL	38.42 TN

Driver:



Weighmaster:

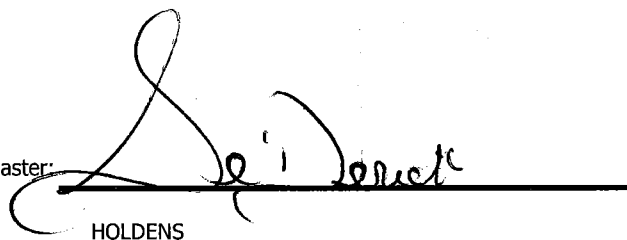

HOLDENS

Indemnification. Customer agrees, by signature above, to indemnify, hold harmless, and defend Republic Services, Inc., its subsidiaries, affiliates, employees, officers and directors from and against any and all liabilities, claims, penalties, forfeitures, suits and the costs and expenses incident thereto, including costs of defense, settlement, and reasonable attorney's fees, which may be incurred, as a result of death or injuries to any person, or damage to any property, contamination of or adverse effects on the environment, caused in whole or in part by the Customer, its employees, or subcontractors in disposing waste at this Facility. In the event Customer delivers Unacceptable Waste (as determined by Republic) Customer agrees to assume all expenses and obligations with the removal and/or resolution of any effects caused by the delivery of such Unacceptable Waste.

Indemnización. Cliente acuerda indemnizar, mantener inmune, y defender Republic Services, Inc., sus subsidiarios, compañías, divisiones, empleados, oficiales y directores contra de cualquiera y de todas responsabilidades, demandas, penas, pérdidas, juicios, pleitos y los costos incidente además, incluyendo costos de defensa, de acuerdo judicial, y de honorarios razonables del abogado, que pueden ser incurridos en, o como resultado de, la muerte o herida personal a cualquier persona, o daños a cualquier característica, propiedad, contaminación de la tierra o efectos ilícitos en esta Facilidad, causado entero o en parte por el cliente, sus empleados, o sus subcontratistas en botar basura en esta Facilidad. En el caso que el Cliente entrega, bota, basura (según lo determinado por Republic) en este Establecimiento basura inaceptable en los reglamentos de este Establecimiento, el Cliente se compromete asumir todos los costos y obligaciones con el retiro y/o la resolución de cualquier dano(s) causado por la entrega de tal basura inaceptable.



SR40176

NON-HAZARDOUS WASTE MANIFEST

MANIFEST # 11800

GENERATOR INFORMATION

Generator Name: Tronox LLC

Address: P.O. Box 55

City: Henderson County: Clark

State: NV Zip: 89009

Site Location (if different): 560 W. Lake Mead

Henderson, NV 89015 (702) 592-7727

CUSTOMER/BILLING INFORMATION

Billing Name: NGE LLC c/o Northgate Environment Management

Address: 300 Frank Ogawa Plaza, Ste 510

City: Oakland County: Alameda

State: CA Zip: 94612

Republic Services Approval #	Description of Waste	Volume/Weight	Expiration Date	Container Type
38251011244	Soil for disposal	38 ⁴⁰ / _{ton}	12-31-2011	Tractor with Dump Trailer(s)
	RZ- _____ # _____			

*Attach Additional Sheet if necessary

I hereby certify that the above-described materials are non-hazardous wastes as defined by 40 CFR 261 or any applicable state law. Further, that the above named materials are properly classified, described, packaged, marked and labeled, and are in proper condition for transportation according to the applicable regulations of the Department of Transportation.

Susan Crowley S. Crowley _____
 Generator/Authorized Agent Name Signature Date Shipped

TRANSPORTER INFORMATION

Transporter Name: Las Vegas Paving

DOT # 191949

Address: 4420 S. Decatur

Truck Number: 175

Las Vegas, NV 89103

Phone Number: (702) 353-4355

I certify no hazardous waste or other regulated substance was knowingly introduced to the waste while in my custody. The waste transported in this vehicle is the waste identified above, to the best of my knowledge.

Larry Harnsteiger [Signature] 10-4-10
 Name of Authorized Agent Signature Date Delivered

DISPOSAL SITE INFORMATION

Site Name: Apex Regional Landfill

Phone No. (702) 599-5920

Address: 13550 U.S. Hwy 93 Las Vegas, NV

I hereby acknowledge receipt of the above described materials

Holden, Se Derrick [Signature] 04 Oct 10
 Name (Print or Type) Signature Date Received

81 Environmental Tech
13550 N Highway 93
Las Vegas, NV 89165

Ticket Type: INBOUND INVOICE

Ticket Number: 1703
Date: 10/05/2010
Time In: 12:14 am
Time Out: 12:36 am

Customer: 001011 - NGE, LLC c/o Northgate Environ Mgmt

Vehicle/Container: 81496P
Contract: Northgate Env. On Site Soils 3825 11
Comment: 3825 10 11244

Gross Weight: 127,380 LB Manual In
Tare Weight: 50,220 LB Manual Out
Net Weight: 77160 LB
Net Tons: 38.58

BOL: 11801

Origin	Yards	Material	Billing Quantity
Not Applicable	0.00 YD	SW CONTAMINATED SOIL	38.58 TN

Driver:

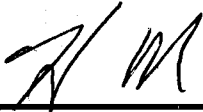

Weighmaster:

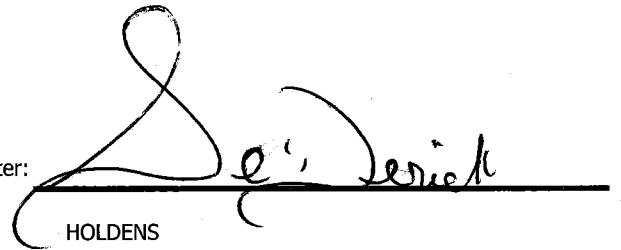

HOLDENS

Indemnification. Customer agrees, by signature above, to indemnify, hold harmless, and defend Republic Services, Inc., its subsidiaries, affiliates, employees, officers and directors from and against any and all liabilities, claims, penalties, forfeitures, suits and the costs and expenses incident thereto, including costs of defense, settlement, and reasonable attorney's fees, which may be incurred, as a result of death or injuries to any person, or damage to any property, contamination of or adverse effects on the environment, caused in whole or in part by the Customer, its employees, or subcontractors in disposing waste at this Facility. In the event Customer delivers Unacceptable Waste (as determined by Republic) Customer agrees to assume all expenses and obligations with the removal and/or resolution of any effects caused by the delivery of such Unacceptable Waste.

Indemnización. Cliente acuerda indemnizar, mantener inmune, y defender Republic Services, Inc., sus subsidiarios, compañías, divisiones, empleados, oficiales y directores contra de cualquiera y de todas responsabilidades, demandas, penas, pérdidas, juicios, pleitos y los costos incidente además, incluyendo costos de defensa, de acuerdo judicial, y de honorarios razonables del abogado, que pueden ser incurridos en, o como resultado de, la muerte o herida personal a cualquier persona, o daños a cualquier característica, propiedad, contaminación de la tierra o efectos ilícitos en esta Facilidad, causado entero o en parte por el cliente, sus empleados, o sus subcontratistas en botar basura en esta Facilidad. En el caso que el Cliente entrega, bota, basura (según lo determinado por Republic) en este Establecimiento basura inaceptable en los reglamentos de este Establecimiento, el Cliente se compromete asumir todos los costos y obligaciones con el retiro y/o la resolución de cualquier dano(s) causado por la entrega de tal basura inaceptable.



NON-HAZARDOUS WASTE MANIFEST

MANIFEST # 11801

GENERATOR INFORMATION

Generator Name: Tronox LLC
Address: P.O. Box 55
City: Henderson County: Clark
State: NV Zip: 89009
Site Location (if different): 560 W. Lake Mead
Henderson, NV 89015 (702) 592-7727

CUSTOMER/BILLING INFORMATION

Billing Name: NGE LLC c/o Northgate Environment Management
Address: 300 Frank Ogawa Plaza, Ste 510
City: Oakland County: Alameda
State: CA Zip: 94612

Table with 5 columns: Republic Services Approval #, Description of Waste, Volume/Weight, Expiration Date, Container Type. Row 1: 38251011244, Soil for disposal, 39 50/10n, 12-31-2011, Tractor with Dump Trailer(s).

*Attach Additional Sheet if necessary

I hereby certify that the above-described materials are non-hazardous wastes as defined by 40 CFR 261 or any applicable state law. Further, that the above named materials are properly classified, described, packaged, marked and labeled, and are in proper condition for transportation according to the applicable regulations of the Department of Transportation.

Susan Crowley (Signature)
Generator/Authorized Agent Name Signature Date Shipped

TRANSPORTER INFORMATION

Transporter Name: Las Vegas Paving DOT # 191949
Address: 4420 S. Decatur Truck Number: 145
Las Vegas, NV 89103 Phone Number: (702) 353-4355

I certify no hazardous waste or other regulated substance was knowingly introduced to the waste while in my custody. The waste transported in this vehicle is the waste identified above, to the best of my knowledge.

Harry M. Bral (Signature)
Name of Authorized Agent Signature Date Delivered 10-4-10

DISPOSAL SITE INFORMATION

Site Name: Apex Regional Landfill Phone No. (702) 599-5920
Address: 13550 U.S. Hwy 93 Las Vegas, NV

I hereby acknowledge receipt of the above described materials
Holden, Se... (Signature)
Name (Print or Type) Signature Date Received 04 Oct 10

81 Environmental Tech
13550 N Highway 93
Las Vegas, NV 89165

Ticket Type: INBOUND INVOICE

Ticket Number: 1704
Date: 10/05/2010
Time In: 12:23 am
Time Out: 12:46 am

Customer: 001011 - NGE, LLC c/o Northgate Environ Mgmt

Vehicle/Container: 81460P
Contract: Northgate Env. On Site Soils 3825 11
Comment: 3825 10 11244

Gross Weight: 130,800 LB Manual In
Tare Weight: 52,440 LB Manual Out
Net Weight: 78360 LB
Net Tons: 39.18

BOL: 11802

Origin	Yards	Material	Billing	Quantity
Not Applicable	0.00 YD	SW CONTAMINATED SOIL	39.18	TN

Driver: _____

Weighmaster: _____

HOLDENS

Indemnification. Customer agrees, by signature above, to indemnify, hold harmless, and defend Republic Services, Inc., its subsidiaries, affiliates, employees, officers and directors from and against any and all liabilities, claims, penalties, forfeitures, suits and the costs and expenses incident thereto, including costs of defense, settlement, and reasonable attorney's fees, which may be incurred, as a result of death or injuries to any person, or damage to any property, contamination of or adverse effects on the environment, caused in whole or in part by the Customer, its employees, or subcontractors in disposing waste at this Facility. In the event Customer delivers Unacceptable Waste (as determined by Republic) Customer agrees to assume all expenses and obligations with the removal and/or resolution of any effects caused by the delivery of such Unacceptable Waste.

Indemnización. Cliente acuerda indemnizar, mantener inmune, y defender Republic Services, Inc., sus subsidiarios, compañías, divisiones, empleados, oficiales y directores contra de cualquiera y de todas responsabilidades, demandas, penas, pérdidas, juicios, pleitos y los costos incidente además, incluyendo costos de defensa, de acuerdo judicial, y de honorarios razonables del abogado, que pueden ser incurridos en, o como resultado de, la muerte o herida personal a cualquier persona, o daños a cualquier característica, propiedad, contaminación de la tierra o efectos ilícitos en esta Facilidad, causado entero o en parte por el cliente, sus empleados, o sus subcontratistas en botar basura en esta Facilidad. En el caso que el Cliente entrega, bota, basura (según lo determinado por Republic) en este Establecimiento basura inaceptable en los reglamentos de este Establecimiento, el Cliente se compromete asumir todos los costos y obligaciones con el retiro y/o la resolución de cualquier dano(s) causado por la entrega de tal basura inaceptable.

81 Environmental Tech
13550 N Highway 93
Las Vegas, NV 89165

Ticket Type: INBOUND INVOICE

Ticket Number: 1705
Date: 10/05/2010
Time In: 12:26 am
Time Out: 12:48 am

Customer: 001011 - NGE, LLC c/o Northgate Environ Mgmt

Vehicle/Container: 84598P
Contract: Northgate Env. On Site Soils 3825 11
Comment: 3825 10 11244

Gross Weight: 130,340 LB Manual In
Tare Weight: 52,000 LB Manual Out
Net Weight: 78340 LB
Net Tons: 39.17

BOL: 11803

Origin	Yards	Material	Billing	Quantity
Not Applicable	0.00 YD	SW CONTAMINATED SOIL	39.17	TN

Driver: _____

Weighmaster: _____

HOLDENS

Indemnification. Customer agrees, by signature above, to indemnify, hold harmless, and defend Republic Services, Inc., its subsidiaries, affiliates, employees, officers and directors from and against any and all liabilities, claims, penalties, forfeitures, suits and the costs and expenses incident thereto, including costs of defense, settlement, and reasonable attorney's fees, which may be incurred, as a result of death or injuries to any person, or damage to any property, contamination of or adverse effects on the environment, caused in whole or in part by the Customer, its employees, or subcontractors in disposing waste at this Facility. In the event Customer delivers Unacceptable Waste (as determined by Republic) Customer agrees to assume all expenses and obligations with the removal and/or resolution of any effects caused by the delivery of such Unacceptable Waste.

Indemnización. Cliente acuerda indemnizar, mantener inmune, y defender Republic Services, Inc., sus subsidiarios, compañías, divisiones, empleados, oficiales y directores contra de cualquiera y de todas responsabilidades, demandas, penas, pérdidas, juicios, pleitos y los costos incidente además, incluyendo costos de defensa, de acuerdo judicial, y de honorarios razonables del abogado, que pueden ser incurridos en, o como resultado de, la muerte o herida personal a cualquier persona, o daños a cualquier característica, propiedad, contaminación de la tierra o efectos ilícitos en esta Facilidad, causado entero o en parte por el cliente, sus empleados, o sus subcontratistas en botar basura en esta Facilidad. En el caso que el Cliente entrega, bota, basura (según lo determinado por Republic) en este Establecimiento basura inaceptable en los reglamentos de este Establecimiento, el Cliente se compromete asumir todos los costos y obligaciones con el retiro y/o la resolución de cualquier dano(s) causado por la entrega de tal basura inaceptable.



NON-HAZARDOUS WASTE MANIFEST

MANIFEST # 11803

GENERATOR INFORMATION

Generator Name: Tronox LLC
Address: P.O. Box 55
City: Henderson County: Clark
State: NV Zip: 89009
Site Location (if different): 560 W. Lake Mead
Henderson, NV 89015 (702) 592-7727

CUSTOMER/BILLING INFORMATION

Billing Name: NGE LLC c/o Northgate Environment Management
Address: 300 Frank Ogawa Plaza, Ste 510
City: Oakland County: Alameda
State: CA Zip: 94612

Table with 5 columns: Republic Services Approval #, Description of Waste, Volume/Weight, Expiration Date, Container Type. Row 1: 38251011244, Soil for disposal, 39 1/2 Ton, 12-31-2011, Tractor with Dump Trailer(s).

*Attach Additional Sheet if necessary

I hereby certify that the above-described materials are non-hazardous wastes as defined by 40 CFR 261 or any applicable state law. Further, that the above named materials are properly classified, described, packaged, marked and labeled, and are in proper condition for transportation according to the applicable regulations of the Department of Transportation.

Susan Crowley (Name) tom crowley (Signature) Date Shipped

TRANSPORTER INFORMATION

Transporter Name: Las Vegas Paving DOT # 191949
Address: 4420 S. Decatur Truck Number: 28
Las Vegas, NV 89103 Phone Number: (702) 353-4355

I certify no hazardous waste or other regulated substance was knowingly introduced to the waste while in my custody. The waste transported in this vehicle is the waste identified above, to the best of my knowledge.

KALGI (Name) [Signature] (Signature) 12-4-10 (Date Delivered)

DISPOSAL SITE INFORMATION

Site Name: Apex Regional Landfill Phone No. (702) 599-5920
Address: 13550 U.S. Hwy 93 Las Vegas, NV

I hereby acknowledge receipt of the above described materials
Holden, Se... (Name) [Signature] (Signature) 0504 2010 (Date Received)

81 Environmental Tech
13550 N Highway 93
Las Vegas, NV 89165

Ticket Type: INBOUND INVOICE

Ticket Number: 1706
Date: 10/05/2010
Time In: 12:32 am
Time Out: 12:52 am

Customer: 001011 - NGE, LLC c/o Northgate Environ Mgmt

Vehicle/Container: 76810P
Contract: Northgate Env. On Site Soils 3825 1f
Comment: 3825 10 11244

Gross Weight: 133,940 LB Manual In
Tare Weight: 54,240 LB Manual Out
Net Weight: 79700 LB
Net Tons: 39.85

BOL: 11804

Origin	Yards	Material	Billing Quantity
Not Applicable	0.00 YD	SW CONTAMINATED SOIL	39.85 TN

Driver:



Weighmaster:

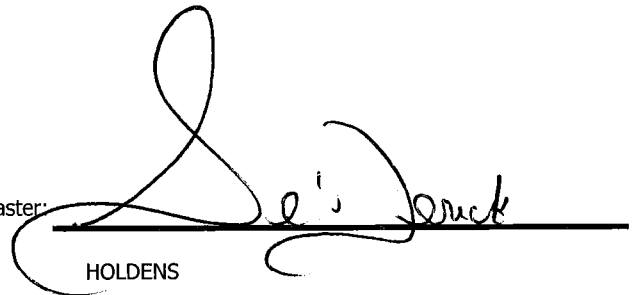

HOLDENS

Indemnification. Customer agrees, by signature above, to indemnify, hold harmless, and defend Republic Services, Inc., its subsidiaries, affiliates, employees, officers and directors from and against any and all liabilities, claims, penalties, forfeitures, suits and the costs and expenses incident thereto, including costs of defense, settlement, and reasonable attorney's fees, which may be incurred, as a result of death or injuries to any person, or damage to any property, contamination of or adverse effects on the environment, caused in whole or in part by the Customer, its employees, or subcontractors in disposing waste at this Facility. In the event Customer delivers Unacceptable Waste (as determined by Republic) Customer agrees to assume all expenses and obligations with the removal and/or resolution of any effects caused by the delivery of such Unacceptable Waste.

Indemnización. Cliente acuerda indemnizar, mantener inmune, y defender Republic Services, Inc., sus subsidiarios, compañías, divisiones, empleados, oficiales y directores contra de cualquiera y de todas responsabilidades, demandas, penas, pérdidas, juicios, pleitos y los costos incidente además, incluyendo costos de defensa, de acuerdo judicial, y de honorarios razonables del abogado, que pueden ser incurridos en, o como resultado de, la muerte o herida personal a cualquier persona, o daños a cualquier característica, propiedad, contaminación de la tierra o efectos ilícitos en esta Facilidad, causado entero o en parte por el cliente, sus empleados, o sus subcontratistas en botar basura en esta Facilidad. En el caso que el Cliente entrega, bota, basura (según lo determinado por Republic) en este Establecimiento basura inaceptable en los reglamentos de este Establecimiento, el Cliente se compromete asumir todos los costos y obligaciones con el retiro y/o la resolución de cualquier dano(s) causado por la entrega de tal basura inaceptable.



NON-HAZARDOUS WASTE MANIFEST

MANIFEST # 11804

GENERATOR INFORMATION

Generator Name: Tronox LLC

Address: P.O. Box 55

City: Henderson County: Clark

State: NV Zip: 89009

Site Location (if different): 560 W. Lake Mead

Henderson, NV 89015 (702) 592-7727

CUSTOMER/BILLING INFORMATION

Billing Name: NGE LLC c/o Northgate Environment Management

Address: 300 Frank Ogawa Plaza, Ste 510

City: Oakland County: Alameda

State: CA Zip: 94612

Republic Services Approval #	Description of Waste	Volume/Weight	Expiration Date	Container Type
38251011244	Soil for disposal	39 ⁹⁵ ton	12-31-2011	Tractor with Dump Trailer(s)
	RZ- #			

*Attach Additional Sheet if necessary

I hereby certify that the above-described materials are non-hazardous wastes as defined by 40 CFR 261 or any applicable state law. Further, that the above named materials are properly classified, described, packaged, marked and labeled, and are in proper condition for transportation according to the applicable regulations of the Department of Transportation.

Susan Crowley

Susan Crowley

Generator/Authorized Agent Name

Signature

Date Shipped

TRANSPORTER INFORMATION

Transporter Name: Las Vegas Paving

DOT # 191949

Address: 4420 S. Decatur

Truck Number: 241

Las Vegas, NV 89103

Phone Number: (702) 353-4355

I certify no hazardous waste or other regulated substance was knowingly introduced to the waste while in my custody. The waste transported in this vehicle is the waste identified above, to the best of my knowledge.

KEVIN JACKSON

[Signature]

10-4-2010

Name of Authorized Agent

Signature

Date Delivered

DISPOSAL SITE INFORMATION

Site Name: Apex Regional Landfill

Phone No. (702) 599-5920

Address: 13550 U.S. Hwy 93 Las Vegas, NV

I hereby acknowledge receipt of the above described materials

Hoblen, Se' Derrell

[Signature]

09/30/10

Name (Print or Type)

Signature

Date Received

81 Environmental Tech
13550 N Highway 93
Las Vegas, NV 89165

Ticket Type: INBOUND INVOICE

Ticket Number: 1707
Date: 10/05/2010
Time In: 12:34 am
Time Out: 12:54 am

Customer: 001011 - NGE, LLC c/o Northgate Environ Mgmt

Vehicle/Container: 82418P
Contract: Northgate Env. On Site Soils 3825 11
Comment: 3825 10 11244

Gross Weight: 137,660 LB Manual In
Tare Weight: 66,140 LB Manual Out
Net Weight: 71520 LB
Net Tons: 35.76

BOL: 11805

Origin	Yards	Material	Billing	Quantity
Not Applicable	0.00 YD	SW CONTAMINATED SOIL	35.76	TN

Driver: _____

Weighmaster: _____

HOLDENS

Indemnification. Customer agrees, by signature above, to indemnify, hold harmless, and defend Republic Services, Inc., its subsidiaries, affiliates, employees, officers and directors from and against any and all liabilities, claims, penalties, forfeitures, suits and the costs and expenses incident thereto, including costs of defense, settlement, and reasonable attorney's fees, which may be incurred, as a result of death or injuries to any person, or damage to any property, contamination of or adverse effects on the environment, caused in whole or in part by the Customer, its employees, or subcontractors in disposing waste at this Facility. In the event Customer delivers Unacceptable Waste (as determined by Republic) Customer agrees to assume all expenses and obligations with the removal and/or resolution of any effects caused by the delivery of such Unacceptable Waste.

Indemnización. Cliente acuerda indemnizar, mantener inmune, y defender Republic Services, Inc., sus subsidiarios, compañías, divisiones, empleados, oficiales y directores contra de cualquiera y de todas responsabilidades, demandas, penas, pérdidas, juicios, pleitos y los costos incidente además, incluyendo costos de defensa, de acuerdo judicial, y de honorarios razonables del abogado, que pueden ser incurridos en, o como resultado de, la muerte o herida personal a cualquier persona, o daños a cualquier característica, propiedad, contaminación de la tierra o efectos ilícitos en esta Facilidad, causado entero o en parte por el cliente, sus empleados, o sus subcontratistas en botar basura en esta Facilidad. En el caso que el Cliente entrega, bota, basura (según lo determinado por Republic) en este Establecimiento basura inaceptable en los reglamentos de este Establecimiento, el Cliente se compromete asumir todos los costos y obligaciones con el retiro y/o la resolución de cualquier dano(s) causado por la entrega de tal basura inaceptable.



NON-HAZARDOUS WASTE MANIFEST

MANIFEST # 11805

GENERATOR INFORMATION

Generator Name: Tronox LLC
Address: P.O. Box 55
City: Henderson County: Clark
State: NV Zip: 89009
Site Location (if different): 560 W. Lake Mead
Henderson, NV 89015 (702) 592-7727

CUSTOMER/BILLING INFORMATION

Billing Name: NGE LLC c/o Northgate Environment Management
Address: 300 Frank Ogawa Plaza, Ste 510
City: Oakland County: Alameda
State: CA Zip: 94612

Table with 5 columns: Republic Services Approval #, Description of Waste, Volume/Weight, Expiration Date, Container Type. Row 1: 38251011244, Soil for disposal, 35 70 ton, 12-31-2011, Tractor with Dump Trailer(s).

*Attach Additional Sheet if necessary

I hereby certify that the above-described materials are non-hazardous wastes as defined by 40 CFR 261 or any applicable state law. Further, that the above named materials are properly classified, described, packaged, marked and labeled, and are in proper condition for transportation according to the applicable regulations of the Department of Transportation.

Susan Crowley (Signature)
Generator/Authorized Agent Name Signature Date Shipped

TRANSPORTER INFORMATION

Transporter Name: Las Vegas Paving DOT # 191949
Address: 4420 S. Decatur Truck Number: 220
Las Vegas, NV 89103 Phone Number: (702) 353-4355

I certify no hazardous waste or other regulated substance was knowingly introduced to the waste while in my custody. The waste transported in this vehicle is the waste identified above, to the best of my knowledge.

STEVE TAYLOR (Signature) 10-4-10
Name of Authorized Agent Signature Date Delivered

DISPOSAL SITE INFORMATION

Site Name: Apex Regional Landfill Phone No. (702) 599-5920
Address: 13550 U.S. Hwy 93 Las Vegas, NV

I hereby acknowledge receipt of the above described materials
Hobbs, Se' Derrick (Signature) Le'Derrick Holden (Signature) 04 Oct 10
Name (Print or Type) Signature Date Received

81 Environmental Tech
13550 N Highway 93
Las Vegas, NV 89165

Ticket Type: INBOUND INVOICE

Ticket Number: 1708
Date: 10/05/2010
Time In: 12:45 am
Time Out: 1:09 am

Customer: 001011 - NGE, LLC c/o Northgate Environ Mgmt

Vehicle/Container: 82418P
Contract: Northgate Env. On Site Soils 3825 11
Comment: 3825 10 11244

Gross Weight: 132,420 LB Manual In
Tare Weight: 54,620 LB Manual Out
Net Weight: 77800 LB
Net Tons: 38.90

BOL: 11807

Origin	Yards	Material	Billing	Quantity
Not Applicable	0.00 YD	SW CONTAMINATED SOIL	38.90	TN

Driver:

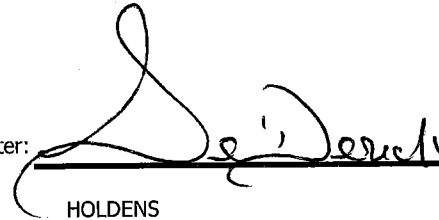

Weighmaster:

HOLDENS

Indemnification. Customer agrees, by signature above, to indemnify, hold harmless, and defend Republic Services, Inc., its subsidiaries, affiliates, employees, officers and directors from and against any and all liabilities, claims, penalties, forfeitures, suits and the costs and expenses incident thereto, including costs of defense, settlement, and reasonable attorney's fees, which may be incurred, as a result of death or injuries to any person, or damage to any property, contamination of or adverse effects on the environment, caused in whole or in part by the Customer, its employees, or subcontractors in disposing waste at this Facility. In the event Customer delivers Unacceptable Waste (as determined by Republic) Customer agrees to assume all expenses and obligations with the removal and/or resolution of any effects caused by the delivery of such Unacceptable Waste.

Indemnización. Cliente acuerda indemnizar, mantener inmune, y defender Republic Services, Inc., sus subsidiarios, compañías, divisiones, empleados, oficiales y directores contra de cualquiera y de todas responsabilidades, demandas, penas, pérdidas, juicios, pleitos y los costos incidente además, incluyendo costos de defensa, de acuerdo judicial, y de honorarios razonables del abogado, que pueden ser incurridos en, o como resultado de, la muerte o herida personal a cualquier persona, o daños a cualquier característica, propiedad, contaminación de la tierra o efectos ilícitos en esta Facilidad, causado entero o en parte por el cliente, sus empleados, o sus subcontratistas en botar basura en esta Facilidad. En el caso que el Cliente entrega, bota, basura (según lo determinado por Republic) en este Establecimiento basura inaceptable en los reglamentos de este Establecimiento, el Cliente se compromete asumir todos los costos y obligaciones con el retiro y/o la resolución de cualquier dano(s) causado por la entrega de tal basura inaceptable.



NON-HAZARDOUS WASTE MANIFEST

MANIFEST # 11807

GENERATOR INFORMATION

Generator Name: Tronox LLC

Address: P.O. Box 55

City: Henderson County: Clark

State: NV Zip: 89009

Site Location (if different): 560 W. Lake Mead

Henderson, NV 89015 (702) 592-7727

CUSTOMER/BILLING INFORMATION

Billing Name: NGE LLC c/o Northgate Environment Management

Address: 300 Frank Ogawa Plaza, Ste 510

City: Oakland County: Alameda

State: CA Zip: 94612

Republic Services Approval #	Description of Waste	Volume/Weight	Expiration Date	Container Type
38251011244	Soil for disposal	38 ⁹⁰ / _{ton}	12-31-2011	Tractor with Dump Trailer(s)
	RZ- #			

*Attach Additional Sheet if necessary

I hereby certify that the above-described materials are non-hazardous wastes as defined by 40 CFR 261 or any applicable state law. Further, that the above named materials are properly classified, described, packaged, marked and labeled, and are in proper condition for transportation according to the applicable regulations of the Department of Transportation.

Susan Crowley

Susan Crowley

Generator/Authorized Agent Name

Signature

Date Shipped

TRANSPORTER INFORMATION

Transporter Name: Las Vegas Paving

DOT # 191949

Address: 4420 S. Decatur

Truck Number: 261

Las Vegas, NV 89103

Phone Number: (702) 353-4355

I certify no hazardous waste or other regulated substance was knowingly introduced to the waste while in my custody. The waste transported in this vehicle is the waste identified above, to the best of my knowledge.

Patrick Miller

Patrick Miller

400710

Name of Authorized Agent

Signature

Date Delivered

DISPOSAL SITE INFORMATION

Site Name: Apex Regional Landfill

Phone No. (702) 599-5920

Address: 13550 U.S. Hwy 93 Las Vegas, NV

I hereby acknowledge receipt of the above described materials

De' Derrick Holden

05 Oct 10

Name (Print or Type)

Signature

Date Received

81 Environmental Tech
13550 N Highway 93
Las Vegas, NV 89165

Ticket Type: INBOUND INVOICE

Ticket Number: 1709
Date: 10/05/2010
Time In: 12:45 am
Time Out: 1:15 am

Customer: 001011 - NGE, LLC c/o Northgate Environ Mgmt

Vehicle/Container: 44564A
Contract: Northgate Env. On Site Soils 3825 11
Comment: 3825 10 11244

Gross Weight: 130,860 LB Manual In
Tare Weight: 49,040 LB Manual Out
Net Weight: 81820 LB
Net Tons: 40.91

BOL: 11806

Origin	Yards	Material	Billing	Quantity
Not Applicable	0.00 YD	SW CONTAMINATED SOIL	40.91	TN

Driver:

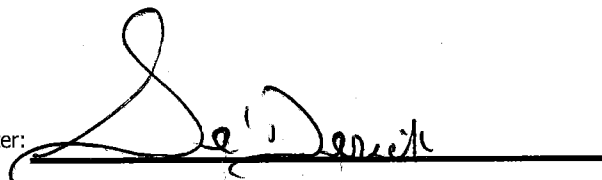

Weighmaster:

HOLDENS

Indemnification. Customer agrees, by signature above, to indemnify, hold harmless, and defend Republic Services, Inc., its subsidiaries, affiliates, employees, officers and directors from and against any and all liabilities, claims, penalties, forfeitures, suits and the costs and expenses incident thereto, including costs of defense, settlement, and reasonable attorney's fees, which may be incurred, as a result of death or injuries to any person, or damage to any property, contamination of or adverse effects on the environment, caused in whole or in part by the Customer, its employees, or subcontractors in disposing waste at this Facility. In the event Customer delivers Unacceptable Waste (as determined by Republic) Customer agrees to assume all expenses and obligations with the removal and/or resolution of any effects caused by the delivery of such Unacceptable Waste.

Indemnización. Cliente acuerda indemnizar, mantener inmune, y defender Republic Services, Inc., sus subsidiarios, compañías, divisiones, empleados, oficiales y directores contra de cualquiera y de todas responsabilidades, demandas, penas, pérdidas, juicios, pleitos y los costos incidente además, incluyendo costos de defensa, de acuerdo judicial, y de honorarios razonables del abogado, que pueden ser incurridos en, o como resultado de, la muerte o herida personal a cualquier persona, o daños a cualquier característica, propiedad, contaminación de la tierra o efectos ilícitos en esta Facilidad, causado entero o en parte por el cliente, sus empleados, o sus subcontratistas en botar basura en esta Facilidad. En el caso que el Cliente entrega, bota, basura (según lo determinado por Republic) en este Establecimiento basura inaceptable en los reglamentos de este Establecimiento, el Cliente se compromete asumir todos los costos y obligaciones con el retiro y/o la resolución de cualquier dano(s) causado por la entrega de tal basura inaceptable.



NON-HAZARDOUS WASTE MANIFEST

MANIFEST # 11806

GENERATOR INFORMATION

Generator Name: Tronox LLC
Address: P.O. Box 55
City: Henderson County: Clark
State: NV Zip: 89009
Site Location (if different): 560 W. Lake Mead
Henderson, NV 89015 (702) 592-7727

CUSTOMER/BILLING INFORMATION

Billing Name: NGE LLC c/o Northgate Environment Management
Address: 300 Frank Ogawa Plaza, Ste 510
City: Oakland County: Alameda
State: CA Zip: 94612

Table with 5 columns: Republic Services Approval #, Description of Waste, Volume/Weight, Expiration Date, Container Type. Row 1: 38251011244, Soil for disposal, 40 91/ton, 12-31-2011, Tractor with Dump Trailer(s).

*Attach Additional Sheet if necessary

I hereby certify that the above-described materials are non-hazardous wastes as defined by 40 CFR 261 or any applicable state law. Further, that the above named materials are properly classified, described, packaged, marked and labeled, and are in proper condition for transportation according to the applicable regulations of the Department of Transportation.

Susan Crowley
Generator/Authorized Agent Name Signature Date Shipped

TRANSPORTER INFORMATION

Transporter Name: Las Vegas Paving DOT # 191949
Address: 4420 S. Decatur Truck Number: K003
Las Vegas, NV 89103 Phone Number: (702) 353-4355

I certify no hazardous waste or other regulated substance was knowingly introduced to the waste while in my custody. The waste transported in this vehicle is the waste identified above, to the best of my knowledge.

Asepcion
Name of Authorized Agent Signature Date Delivered

DISPOSAL SITE INFORMATION

Site Name: Apex Regional Landfill Phone No. (702) 599-5920
Address: 13550 U.S. Hwy 93 Las Vegas, NV

I hereby acknowledge receipt of the above described materials
Name (Print or Type) Signature Date Received

81 Environmental Tech
13550 N Highway 93
Las Vegas, NV 89165

Ticket Type: INBOUND INVOICE

Ticket Number: 1710
Date: 10/05/2010
Time In: 12:54 am
Time Out: 1:15 am

Customer: 001011 - NGE, LLC c/o Northgate Environ Mgmt

Vehicle/Container: 76811P
Contract: Northgate Env. On Site Soils 3825 11
Comment: 3825 10 11244

Gross Weight: 131,940 LB Manual In
Tare Weight: 52,760 LB Manual Out
Net Weight: 79180 LB
Net Tons: 39.59

BOL: 11809

Origin	Yards	Material	Billing	Quantity
Not Applicable	0.00 YD	SW CONTAMINATED SOIL	39.59	TN

Driver: _____

Weighmaster: _____

HOLDENS

Indemnification. Customer agrees, by signature above, to indemnify, hold harmless, and defend Republic Services, Inc., its subsidiaries, affiliates, employees, officers and directors from and against any and all liabilities, claims, penalties, forfeitures, suits and the costs and expenses incident thereto, including costs of defense, settlement, and reasonable attorney's fees, which may be incurred, as a result of death or injuries to any person, or damage to any property, contamination of or adverse effects on the environment, caused in whole or in part by the Customer, its employees, or subcontractors in disposing waste at this Facility. In the event Customer delivers Unacceptable Waste (as determined by Republic) Customer agrees to assume all expenses and obligations with the removal and/or resolution of any effects caused by the delivery of such Unacceptable Waste.

Indemnización. Cliente acuerda indemnizar, mantener inmune, y defender Republic Services, Inc., sus subsidiarios, compañías, divisiones, empleados, oficiales y directores contra de cualquiera y de todas responsabilidades, demandas, penas, pérdidas, juicios, pleitos y los costos incidente además, incluyendo costos de defensa, de acuerdo judicial, y de honorarios razonables del abogado, que pueden ser incurridos en, o como resultado de, la muerte o herida personal a cualquier persona, o daños a cualquier característica, propiedad, contaminación de la tierra o efectos ilícitos en esta Facilidad, causado entero o en parte por el cliente, sus empleados, o sus subcontratistas en botar basura en esta Facilidad. En el caso que el Cliente entrega, bota, basura (según lo determinado por Republic) en este Establecimiento basura inaceptable en los reglamentos de este Establecimiento, el Cliente se compromete asumir todos los costos y obligaciones con el retiro y/o la resolución de cualquier dano(s) causado por la entrega de tal basura inaceptable.



NON-HAZARDOUS WASTE MANIFEST

MANIFEST # 11809

GENERATOR INFORMATION

Generator Name: Tronox LLC

Address: P.O. Box 55

City: Henderson County: Clark

State: NV Zip: 89009

Site Location (if different): 560 W. Lake Mead

Henderson, NV 89015 (702) 592-7727

CUSTOMER/BILLING INFORMATION

Billing Name: NGE LLC c/o Northgate Environment Management

Address: 300 Frank Ogawa Plaza, Ste 510

City: Oakland County: Alameda

State: CA Zip: 94612

Republic Services Approval #	Description of Waste	Volume/Weight	Expiration Date	Container Type
38251011244	Soil for disposal	39 ⁵⁵ / ₁₀₀	12-31-2011	Tractor with Dump Trailer(s)
	RZ- _____ # _____			

*Attach Additional Sheet if necessary

I hereby certify that the above-described materials are non-hazardous wastes as defined by 40 CFR 261 or any applicable state law. Further, that the above named materials are properly classified, described, packaged, marked and labeled, and are in proper condition for transportation according to the applicable regulations of the Department of Transportation.

Susan Crowley

Susan Crowley

Generator/Authorized Agent Name

Signature

Date Shipped

TRANSPORTER INFORMATION

Transporter Name: Las Vegas Paving

DOT # 191949

Address: 4420 S. Decatur

Truck Number: 242

Las Vegas, NV 89103

Phone Number: (702) 353-4355

I certify no hazardous waste or other regulated substance was knowingly introduced to the waste while in my custody. The waste transported in this vehicle is the waste identified above, to the best of my knowledge.

STEVEN ADYES

Steven Adyes

10-4-10

Name of Authorized Agent

Signature

Date Delivered

DISPOSAL SITE INFORMATION

Site Name: Apex Regional Landfill

Phone No. (702) 599-5920

Address: 13550 U.S. Hwy 93 Las Vegas, NV

I hereby acknowledge receipt of the above described materials

Holden, S. Derrick

S. Derrick Holden

05 Oct 10

Name (Print or Type)

Signature

Date Received

81 Environmental Tech
13550 N Highway 93
Las Vegas, NV 89165

Ticket Type: INBOUND INVOICE

Ticket Number: 1711
Date: 10/05/2010
Time In: 12:56 am
Time Out: 1:21 am

Customer: 001011 - NGE, LLC c/o Northgate Environ Mgmt

Vehicle/Container: 44165A
Contract: Northgate Env. On Site Soils 3825 11
Comment: 3825 10 11244

Gross Weight: 133,520 LB Manual In
Tare Weight: 48,540 LB Manual Out
Net Weight: 84980 LB
Net Tons: 42.49

BOL: 11808

Origin	Yards	Material	Billing Quantity
Not Applicable	0.00 YD	SW CONTAMINATED SOIL	42.49 TN

Driver:

CEBU

Weighmaster:

[Signature]
HOLDENS

Indemnification. Customer agrees, by signature above, to indemnify, hold harmless, and defend Republic Services, Inc., its subsidiaries, affiliates, employees, officers and directors from and against any and all liabilities, claims, penalties, forfeitures, suits and the costs and expenses incident thereto, including costs of defense, settlement, and reasonable attorney's fees, which may be incurred, as a result of death or injuries to any person, or damage to any property, contamination of or adverse effects on the environment, caused in whole or in part by the Customer, its employees, or subcontractors in disposing waste at this Facility. In the event Customer delivers Unacceptable Waste (as determined by Republic) Customer agrees to assume all expenses and obligations with the removal and/or resolution of any effects caused by the delivery of such Unacceptable Waste.

Indemnización. Cliente acuerda indemnizar, mantener inmune, y defender Republic Services, Inc., sus subsidiarios, compañías, divisiones, empleados, oficiales y directores contra de cualquiera y de todas responsabilidades, demandas, penas, pérdidas, juicios, pleitos y los costos incidente además, incluyendo costos de defensa, de acuerdo judicial, y de honorarios razonables del abogado, que pueden ser incurridos en, o como resultado de, la muerte o herida personal a cualquier persona, o daños a cualquier característica, propiedad, contaminación de la tierra o efectos ilícitos en esta Facilidad, causado entero o en parte por el cliente, sus empleados, o sus subcontratistas en botar basura en esta Facilidad. En el caso que el Cliente entrega, bota, basura (según lo determinado por Republic) en este Establecimiento basura inaceptable en los reglamentos de este Establecimiento, el Cliente se compromete asumir todos los costos y obligaciones con el retiro y/o la resolución de cualquier dano(s) causado por la entrega de tal basura inaceptable.



NON-HAZARDOUS WASTE MANIFEST

MANIFEST # 11808

GENERATOR INFORMATION

Generator Name: Tronox LLC
Address: P.O. Box 55
City: Henderson County: Clark
State: NV Zip: 89009
Site Location (if different): 560 W. Lake Mead
Henderson, NV 89015 (702) 592-7727

CUSTOMER/BILLING INFORMATION

Billing Name: NGE LLC c/o Northgate Environment Management
Address: 300 Frank Ogawa Plaza, Ste 510
City: Oakland County: Alameda
State: CA Zip: 94612

Table with 5 columns: Republic Services Approval #, Description of Waste, Volume/Weight, Expiration Date, Container Type. Row 1: 38251011244, Soil for disposal, 412.99 ton, 12-31-2011, Tractor with Dump Trailer(s). Row 2: RZ- #

*Attach Additional Sheet if necessary

I hereby certify that the above-described materials are non-hazardous wastes as defined by 40 CFR 261 or any applicable state law. Further, that the above named materials are properly classified, described, packaged, marked and labeled, and are in proper condition for transportation according to the applicable regulations of the Department of Transportation.

Susan Crowley
Generator/Authorized Agent Name Signature Date Shipped

TRANSPORTER INFORMATION

Transporter Name: Las Vegas Paving DOT # 191949
Address: 4420 S. Decatur Truck Number: K002
Las Vegas, NV 89103 Phone Number: (702) 353-4355

I certify no hazardous waste or other regulated substance was knowingly introduced to the waste while in my custody. The waste transported in this vehicle is the waste identified above, to the best of my knowledge.

ABELLANO
Name of Authorized Agent Signature Date Delivered 10/04/10

DISPOSAL SITE INFORMATION

Site Name: Apex Regional Landfill Phone No. (702) 599-5920
Address: 13550 U.S. Hwy 93 Las Vegas, NV

I hereby acknowledge receipt of the above described materials
Name (Print or Type) Signature Date Received 05 Oct 10

81 Environmental Tech
13550 N Highway 93
Las Vegas, NV 89165

Ticket Type: INBOUND INVOICE

Ticket Number: 1712
Date: 10/05/2010
Time In: 1:00 am
Time Out: 1:24 am

Customer: 001011 - NGE, LLC c/o Northgate Environ Mgmt

Vehicle/Container: 68263P
Contract: Northgate Env. On Site Soils 3825 11
Comment: 3825 10 11244

Gross Weight: 126,580 LB Manual In
Tare Weight: 53,340 LB Manual Out
Net Weight: 73240 LB
Net Tons: 36.62

BOL: 11810

Origin	Yards	Material	Billing	Quantity
Not Applicable	0.00 YD	SW CONTAMINATED SOIL	36.62	TN

Driver:

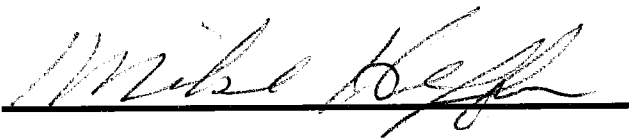

Weighmaster:

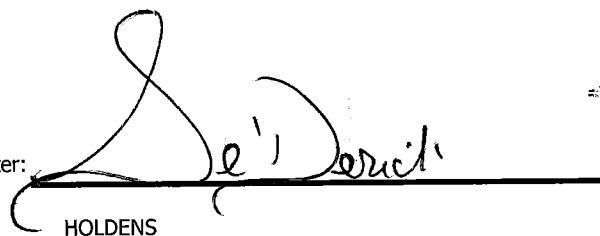

HOLDENS

Indemnification. Customer agrees, by signature above, to indemnify, hold harmless, and defend Republic Services, Inc., its subsidiaries, affiliates, employees, officers and directors from and against any and all liabilities, claims, penalties, forfeitures, suits and the costs and expenses incident thereto, including costs of defense, settlement, and reasonable attorney's fees, which may be incurred, as a result of death or injuries to any person, or damage to any property, contamination of or adverse effects on the environment, caused in whole or in part by the Customer, its employees, or subcontractors in disposing waste at this Facility. In the event Customer delivers Unacceptable Waste (as determined by Republic) Customer agrees to assume all expenses and obligations with the removal and/or resolution of any effects caused by the delivery of such Unacceptable Waste.

Indemnización. Cliente acuerda indemnizar, mantener inmune, y defender Republic Services, Inc., sus subsidiarios, compañías, divisiones, empleados, oficiales y directores contra de cualquiera y de todas responsabilidades, demandas, penas, pérdidas, juicios, pleitos y los costos incidente además, incluyendo costos de defensa, de acuerdo judicial, y de honorarios razonables del abogado, que pueden ser incurridos en, o como resultado de, la muerte o herida personal a cualquier persona, o daños a cualquier característica, propiedad, contaminación de la tierra o efectos ilícitos en esta Facilidad, causado entero o en parte por el cliente, sus empleados, o sus subcontratistas en botar basura en esta Facilidad. En el caso que el Cliente entrega, bota, basura (según lo determinado por Republic) en este Establecimiento basura inaceptable en los reglamentos de este Establecimiento, el Cliente se compromete asumir todos los costos y obligaciones con el retiro y/o la resolución de cualquier dano(s) causado por la entrega de tal basura inaceptable.



NON-HAZARDOUS WASTE MANIFEST

MANIFEST # 11810

GENERATOR INFORMATION

Generator Name: Tronox LLC
Address: P.O. Box 55
City: Henderson County: Clark
State: NV Zip: 89009
Site Location (if different): 560 W. Lake Mead
Henderson, NV 89015 (702) 592-7727

CUSTOMER/BILLING INFORMATION

Billing Name: NGE LLC c/o Northgate Environment Management
Address: 300 Frank Ogawa Plaza, Ste 510
City: Oakland County: Alameda
State: CA Zip: 94612

Table with 5 columns: Republic Services Approval #, Description of Waste, Volume/Weight, Expiration Date, Container Type. Row 1: 38251011244, Soil for disposal, 36 4/5 ton, 12-31-2011, Tractor with Dump Trailer(s).

*Attach Additional Sheet if necessary

I hereby certify that the above-described materials are non-hazardous wastes as defined by 40 CFR 261 or any applicable state law. Further, that the above named materials are properly classified, described, packaged, marked and labeled, and are in proper condition for transportation according to the applicable regulations of the Department of Transportation.

Susan Crowley (Signature)
Generator/Authorized Agent Name Signature Date Shipped

TRANSPORTER INFORMATION

Transporter Name: Las Vegas Paving DOT # 191949
Address: 4420 S. Decatur Truck Number: 2711
Las Vegas, NV 89103 Phone Number: (702) 353-4355

I certify no hazardous waste or other regulated substance was knowingly introduced to the waste while in my custody. The waste transported in this vehicle is the waste identified above, to the best of my knowledge.

Mike DeFren (Signature)
Name of Authorized Agent Signature Date Delivered 10-4-10

DISPOSAL SITE INFORMATION

Site Name: Apex Regional Landfill Phone No. (702) 599-5920
Address: 13550 U.S. Hwy 93 Las Vegas, NV

I hereby acknowledge receipt of the above described materials
Hilden, Se'wende (Signature)
Name (Print or Type) Signature Date Received 05 Oct 10

81 Environmental Tech
13550 N Highway 93
Las Vegas, NV 89165

Ticket Type: INBOUND INVOICE

Ticket Number: 1713
Date: 10/05/2010
Time In: 1:08 am
Time Out: 1:37 am

Customer: 001011 - NGE, LLC c/o Northgate Environ Mgmt

Vehicle/Container: 86113P
Contract: Northgate Env. On Site Soils 3825 10
Comment: 3825 10 11244

Gross Weight: 138,980 LB Manual In
Tare Weight: 55,340 LB Manual Out
Net Weight: 83640 LB
Net Tons: 41.82

BOL: 11811

Origin	Yards	Material	Billing Quantity
Not Applicable	0.00 YD	SW CONTAMINATED SOIL	41.82 TN

Driver:

J. A. H.

Weighmaster:

Sei Jenik

HOLDENS

Indemnification. Customer agrees, by signature above, to indemnify, hold harmless, and defend Republic Services, Inc., its subsidiaries, affiliates, employees, officers and directors from and against any and all liabilities, claims, penalties, forfeitures, suits and the costs and expenses incident thereto, including costs of defense, settlement, and reasonable attorney's fees, which may be incurred, as a result of death or injuries to any person, or damage to any property, contamination of or adverse effects on the environment, caused in whole or in part by the Customer, its employees, or subcontractors in disposing waste at this Facility. In the event Customer delivers Unacceptable Waste (as determined by Republic) Customer agrees to assume all expenses and obligations with the removal and/or resolution of any effects caused by the delivery of such Unacceptable Waste.

Indemnización. Cliente acuerda indemnizar, mantener inmune, y defender Republic Services, Inc., sus subsidiarios, compañías, divisiones, empleados, oficiales y directores contra de cualquiera y de todas responsabilidades, demandas, penas, pérdidas, juicios, pleitos y los costos incidente además, incluyendo costos de defensa, de acuerdo judicial, y de honorarios razonables del abogado, que pueden ser incurridos en, o como resultado de, la muerte o herida personal a cualquier persona, o daños a cualquier característica, propiedad, contaminación de la tierra o efectos ilícitos en esta Facilidad, causado entero o en parte por el cliente, sus empleados, o sus subcontratistas en botar basura en esta Facilidad. En el caso que el Cliente entrega, bota, basura (según lo determinado por Republic) en este Establecimiento basura inaceptable en los reglamentos de este Establecimiento, el Cliente se compromete asumir todos los costos y obligaciones con el retiro y/o la resolución de cualquier dano(s) causado por la entrega de tal basura inaceptable.



NON-HAZARDOUS WASTE MANIFEST

MANIFEST # 11811

GENERATOR INFORMATION

Generator Name: Tronox LLC
Address: P.O. Box 55
City: Henderson County: Clark
State: NV Zip: 89009
Site Location (if different): 560 W. Lake Mead
Henderson, NV 89015 (702) 592-7727

CUSTOMER/BILLING INFORMATION

Billing Name: NGE LLC c/o Northgate Environment Management
Address: 300 Frank Ogawa Plaza, Ste 510
City: Oakland County: Alameda
State: CA Zip: 94612

Table with 5 columns: Republic Services Approval #, Description of Waste, Volume/Weight, Expiration Date, Container Type. Row 1: 38251011244, Soil for disposal, 41 32/ton, 12-31-2011, Tractor with Dump Trailer(s). Row 2: RZ- #

*Attach Additional Sheet if necessary

I hereby certify that the above-described materials are non-hazardous wastes as defined by 40 CFR 261 or any applicable state law. Further, that the above named materials are properly classified, described, packaged, marked and labeled, and are in proper condition for transportation according to the applicable regulations of the Department of Transportation.

Susan Crowley (Signature)
Generator/Authorized Agent Name Signature Date Shipped

TRANSPORTER INFORMATION

Transporter Name: Las Vegas Paving DOT # 191949
Address: 4420 S. Decatur Truck Number: K0019/7
Las Vegas, NV 89103 Phone Number: (702) 353-4355

I certify no hazardous waste or other regulated substance was knowingly introduced to the waste while in my custody. The waste transported in this vehicle is the waste identified above, to the best of my knowledge.

ALBERTO HERIZERA (Signature) Date Delivered: Oct 4, 2010
Name of Authorized Agent Signature Date Delivered

DISPOSAL SITE INFORMATION

Site Name: Apex Regional Landfill Phone No. (702) 599-5920
Address: 13550 U.S. Hwy 93 Las Vegas, NV

I hereby acknowledge receipt of the above described materials
Holden, S. Derick (Signature) Date Received: 5 Oct 2010
Name (Print or Type) Signature Date Received

81 Environmental Tech
13550 N Highway 93
Las Vegas, NV 89165

Ticket Type: INBOUND INVOICE

Ticket Number: 1714
Date: 10/05/2010
Time In: 1:17 am
Time Out: 1:46 am

Customer: 001011 - NGE, LLC c/o Northgate Environ Mgmt

Vehicle/Container: 44166A
Contract: Northgate Env. On Site Soils 3825 11
Comment: 3825 10 11244

Gross Weight: 141,960 LB Manual In
Tare Weight: 57,040 LB Manual Out
Net Weight: 84920 LB
Net Tons: 42.46

BOL: 11812

Origin	Yards	Material	Billing Quantity
Not Applicable	0.00 YD	SW CONTAMINATED SOIL	42.46 TN

Driver: _____

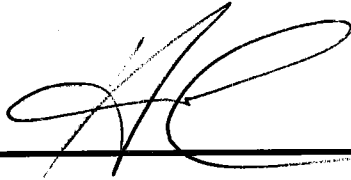

Weighmaster: _____

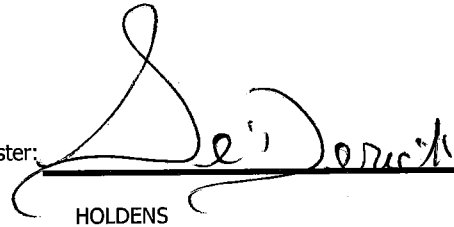
HOLDENS

Indemnification. Customer agrees, by signature above, to indemnify, hold harmless, and defend Republic Services, Inc., its subsidiaries, affiliates, employees, officers and directors from and against any and all liabilities, claims, penalties, forfeitures, suits and the costs and expenses incident thereto, including costs of defense, settlement, and reasonable attorney's fees, which may be incurred, as a result of death or injuries to any person, or damage to any property, contamination of or adverse effects on the environment, caused in whole or in part by the Customer, its employees, or subcontractors in disposing waste at this Facility. In the event Customer delivers Unacceptable Waste (as determined by Republic) Customer agrees to assume all expenses and obligations with the removal and/or resolution of any effects caused by the delivery of such Unacceptable Waste.

Indemnización. Cliente acuerda indemnizar, mantener inmune, y defender Republic Services, Inc., sus subsidiarios, compañías, divisiones, empleados, oficiales y directores contra de cualquiera y de todas responsabilidades, demandas, penas, pérdidas, juicios, pleitos y los costos incidente además, incluyendo costos de defensa, de acuerdo judicial, y de honorarios razonables del abogado, que pueden ser incurridos en, o como resultado de, la muerte o herida personal a cualquier persona, o daños a cualquier característica, propiedad, contaminación de la tierra o efectos ilícitos en esta Facilidad, causado entero o en parte por el cliente, sus empleados, o sus subcontratistas en botar basura en esta Facilidad. En el caso que el Cliente entrega, bota, basura (según lo determinado por Republic) en este Establecimiento basura inaceptable en los reglamentos de este Establecimiento, el Cliente se compromete asumir todos los costos y obligaciones con el retiro y/o la resolución de cualquier dano(s) causado por la entrega de tal basura inaceptable.



NON-HAZARDOUS WASTE MANIFEST

MANIFEST # 11812

GENERATOR INFORMATION

Generator Name: Tronox LLC
Address: P.O. Box 55
City: Henderson County: Clark
State: NV Zip: 89009
Site Location (if different): 560 W. Lake Mead
Henderson, NV 89015 (702) 592-7727

CUSTOMER/BILLING INFORMATION

Billing Name: NGE LLC c/o Northgate Environment Management
Address: 300 Frank Ogawa Plaza, Ste 510
City: Oakland County: Alameda
State: CA Zip: 94612

Table with 5 columns: Republic Services Approval #, Description of Waste, Volume/Weight, Expiration Date, Container Type. Row 1: 38251011244, Soil for disposal, 42 40/100, 12-31-2011, Tractor with Dump Trailer(s). Row 2: RZ- #

*Attach Additional Sheet if necessary

I hereby certify that the above-described materials are non-hazardous wastes as defined by 40 CFR 261 or any applicable state law. Further, that the above named materials are properly classified, described, packaged, marked and labeled, and are in proper condition for transportation according to the applicable regulations of the Department of Transportation.

Susan Crowley
Generator/Authorized Agent Name Signature Date Shipped

TRANSPORTER INFORMATION

Transporter Name: Las Vegas Paving DOT # 191949
Address: 4420 S. Decatur Truck Number: K002
Las Vegas, NV 89103 Phone Number: (702) 353-4355

I certify no hazardous waste or other regulated substance was knowingly introduced to the waste while in my custody. The waste transported in this vehicle is the waste identified above, to the best of my knowledge.

Hugo Castillo
Name of Authorized Agent Signature Date Delivered 10-4-10

DISPOSAL SITE INFORMATION

Site Name: Apex Regional Landfill Phone No. (702) 599-5920
Address: 13550 U.S. Hwy 93 Las Vegas, NV

I hereby acknowledge receipt of the above described materials
Name (Print or Type) Signature Date Received 05 Oct 10

81 Environmental Tech
13550 N Highway 93
Las Vegas, NV 89165

Ticket Type: INBOUND INVOICE

Ticket Number: 1715
Date: 10/05/2010
Time In: 1:22 am
Time Out: 1:50 am

Customer: 001011 - NGE, LLC c/o Northgate Environ Mgmt

Vehicle/Container: 34330A
Contract: Northgate Env. On Site Soils 3825 11
Comment: 3825 10 11244

Gross Weight: 124,260 LB Manual In
Tare Weight: 54,100 LB Manual Out
Net Weight: 70160 LB
Net Tons: 35.08

BOL: 11813

Origin	Yards	Material	Billing	Quantity
Not Applicable	0.00 YD	SW CONTAMINATED SOIL	35.08	TN

Driver:

Weighmaster:

HOLDENS

Indemnification. Customer agrees, by signature above, to indemnify, hold harmless, and defend Republic Services, Inc., its subsidiaries, affiliates, employees, officers and directors from and against any and all liabilities, claims, penalties, forfeitures, suits and the costs and expenses incident thereto, including costs of defense, settlement, and reasonable attorney's fees, which may be incurred, as a result of death or injuries to any person, or damage to any property, contamination of or adverse effects on the environment, caused in whole or in part by the Customer, its employees, or subcontractors in disposing waste at this Facility. In the event Customer delivers Unacceptable Waste (as determined by Republic) Customer agrees to assume all expenses and obligations with the removal and/or resolution of any effects caused by the delivery of such Unacceptable Waste.

Indemnización. Cliente acuerda indemnizar, mantener inmune, y defender Republic Services, Inc., sus subsidiarios, compañías, divisiones, empleados, oficiales y directores contra de cualquiera y de todas responsabilidades, demandas, penas, pérdidas, juicios, pleitos y los costos incidente además, incluyendo costos de defensa, de acuerdo judicial, y de honorarios razonables del abogado, que pueden ser incurridos en, o como resultado de, la muerte o herida personal a cualquier persona, o daños a cualquier característica, propiedad, contaminación de la tierra o efectos ilícitos en esta Facilidad, causado entero o en parte por el cliente, sus empleados, o sus subcontratistas en botar basura en esta Facilidad. En el caso que el Cliente entrega, bota, basura (según lo determinado por Republic) en este Establecimiento basura inaceptable en los reglamentos de este Establecimiento, el Cliente se compromete asumir todos los costos y obligaciones con el retiro y/o la resolución de cualquier dano(s) causado por la entrega de tal basura inaceptable.



NON-HAZARDOUS WASTE MANIFEST

MANIFEST # 11813

GENERATOR INFORMATION

Generator Name: Tronox LLC
Address: P.O. Box 55
City: Henderson County: Clark
State: NV Zip: 89009
Site Location (if different): 560 W. Lake Mead
Henderson, NV 89015 (702) 592-7727

CUSTOMER/BILLING INFORMATION

Billing Name: NGE LLC c/o Northgate Environment Management
Address: 300 Frank Ogawa Plaza, Ste 510
City: Oakland County: Alameda
State: CA Zip: 94612

Table with 5 columns: Republic Services Approval #, Description of Waste, Volume/Weight, Expiration Date, Container Type. Row 1: 38251011244, Soil for disposal, 35 cu yd, 12-31-2011, Tractor with Dump Trailer(s).

*Attach Additional Sheet if necessary

I hereby certify that the above-described materials are non-hazardous wastes as defined by 40 CFR 261 or any applicable state law. Further, that the above named materials are properly classified, described, packaged, marked and labeled, and are in proper condition for transportation according to the applicable regulations of the Department of Transportation.

Susan Crowley (Signature)
Generator/Authorized Agent Name Signature Date Shipped

TRANSPORTER INFORMATION

Transporter Name: Las Vegas Paving DOT # 191949
Address: 4420 S. Decatur Truck Number: 981
Las Vegas, NV 89103 Phone Number: (702) 353-4355

I certify no hazardous waste or other regulated substance was knowingly introduced to the waste while in my custody. The waste transported in this vehicle is the waste identified above, to the best of my knowledge.

bm Kauling JR (Signature)
Name of Authorized Agent Signature Date Delivered 10-5-10

DISPOSAL SITE INFORMATION

Site Name: Apex Regional Landfill Phone No. (702) 599-5920
Address: 13550 U.S. Hwy 93 Las Vegas, NV

I hereby acknowledge receipt of the above described materials
Holden, Se Service (Signature)
Name (Print or Type) Signature Date Received 05 Oct 10

81 Environmental Tech
13550 N Highway 93
Las Vegas, NV 89165

Ticket Type: INBOUND INVOICE

Ticket Number: 1716
Date: 10/05/2010
Time In: 1:33 am
Time Out: 1:59 am

Customer: 001011 - NGE, LLC c/o Northgate Environ Mgmt

Vehicle/Container: 44164A
Contract: Northgate Env. On Site Soils 3825 1f
Comment: 3825 10 11244

Gross Weight: 131,460 LB Manual In
Tare Weight: 56,120 LB Manual Out
Net Weight: 75340 LB
Net Tons: 37.67

BOL: 11814

Origin	Yards	Material	Billing	Quantity
Not Applicable	0.00 YD	SW CONTAMINATED SOIL	37.67	TN

Driver:

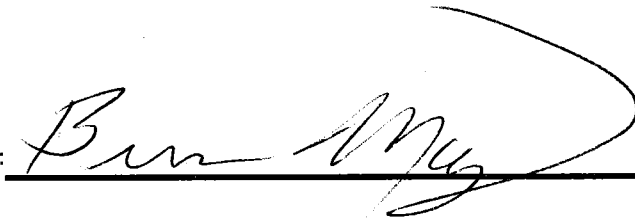

Weighmaster:

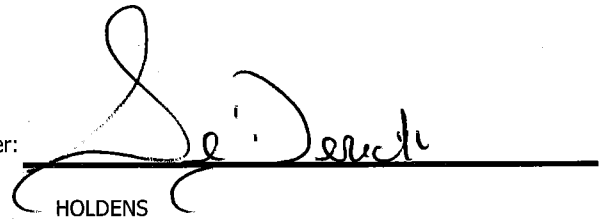

HOLDENS

Indemnification. Customer agrees, by signature above, to indemnify, hold harmless, and defend Republic Services, Inc., its subsidiaries, affiliates, employees, officers and directors from and against any and all liabilities, claims, penalties, forfeitures, suits and the costs and expenses incident thereto, including costs of defense, settlement, and reasonable attorney's fees, which may be incurred, as a result of death or injuries to any person, or damage to any property, contamination of or adverse effects on the environment, caused in whole or in part by the Customer, its employees, or subcontractors in disposing waste at this Facility. In the event Customer delivers Unacceptable Waste (as determined by Republic) Customer agrees to assume all expenses and obligations with the removal and/or resolution of any effects caused by the delivery of such Unacceptable Waste.

Indemnización. Cliente acuerda indemnizar, mantener inmune, y defender Republic Services, Inc., sus subsidiarios, compañías, divisiones, empleados, oficiales y directores contra de cualquiera y de todas responsabilidades, demandas, penas, pérdidas, juicios, pleitos y los costos incidente además, incluyendo costos de defensa, de acuerdo judicial, y de honorarios razonables del abogado, que pueden ser incurridos en, o como resultado de, la muerte o herida personal a cualquier persona, o daños a cualquier característica, propiedad, contaminación de la tierra o efectos ilícitos en esta Facilidad, causado entero o en parte por el cliente, sus empleados, o sus subcontratistas en botar basura en esta Facilidad. En el caso que el Cliente entrega, bota, basura (según lo determinado por Republic) en este Establecimiento basura inaceptable en los reglamentos de este Establecimiento, el Cliente se compromete asumir todos los costos y obligaciones con el retiro y/o la resolución de cualquier dano(s) causado por la entrega de tal basura inaceptable.



NON-HAZARDOUS WASTE MANIFEST

MANIFEST # 11814

GENERATOR INFORMATION

Generator Name: Tronox LLC
Address: P.O. Box 55
City: Henderson County: Clark
State: NV Zip: 89009
Site Location (if different): 560 W. Lake Mead
Henderson, NV 89015 (702) 592-7727

CUSTOMER/BILLING INFORMATION

Billing Name: NGE LLC c/o Northgate Environment Management
Address: 300 Frank Ogawa Plaza, Ste 510
City: Oakland County: Alameda
State: CA Zip: 94612

Table with 5 columns: Republic Services Approval #, Description of Waste, Volume/Weight, Expiration Date, Container Type. Row 1: 38251011244, Soil for disposal, 37 67/70n, 12-31-2011, Tractor with Dump Trailer(s).

*Attach Additional Sheet if necessary

I hereby certify that the above-described materials are non-hazardous wastes as defined by 40 CFR 261 or any applicable state law. Further, that the above named materials are properly classified, described, packaged, marked and labeled, and are in proper condition for transportation according to the applicable regulations of the Department of Transportation.

Susan Crowley
Generator/Authorized Agent Name Signature Date Shipped

TRANSPORTER INFORMATION

Transporter Name: Las Vegas Paving DOT # 191949
Address: 4420 S. Decatur Truck Number: K-006
Las Vegas, NV 89103 Phone Number: (702) 353-4355

I certify no hazardous waste or other regulated substance was knowingly introduced to the waste while in my custody. The waste transported in this vehicle is the waste identified above, to the best of my knowledge.

Brian Mulvey
Name of Authorized Agent Signature Date Delivered 10-8-10

DISPOSAL SITE INFORMATION

Site Name: Apex Regional Landfill Phone No. (702) 599-5920
Address: 13550 U.S. Hwy 93 Las Vegas, NV

I hereby acknowledge receipt of the above described materials
Holden, Se Derick
Name (Print or Type) Signature Date Received 05 Oct 10

81 Environmental Tech
13550 N Highway 93
Las Vegas, NV 89165

Ticket Type: INBOUND INVOICE

Ticket Number: 1717
Date: 10/05/2010
Time In: 1:34 am
Time Out: 2:00 am

Customer: 001011 - NGE, LLC c/o Northgate Environ Mgmt

Vehicle/Container: 192457
Contract: Northgate Env. On Site Soils 3825 11
Comment: 3825 10 11244

Gross Weight: 127,620 LB Manual In
Tare Weight: 53,200 LB Manual Out
Net Weight: 74420 LB
Net Tons: 37.21

BOL: 11815

Origin	Yards	Material	Billing Quantity
Not Applicable	0.00 YD	SW CONTAMINATED SOIL	37.21 TN

Driver: _____

Weighmaster: _____

HOLDENS

Indemnification. Customer agrees, by signature above, to indemnify, hold harmless, and defend Republic Services, Inc., its subsidiaries, affiliates, employees, officers and directors from and against any and all liabilities, claims, penalties, forfeitures, suits and the costs and expenses incident thereto, including costs of defense, settlement, and reasonable attorney's fees, which may be incurred, as a result of death or injuries to any person, or damage to any property, contamination of or adverse effects on the environment, caused in whole or in part by the Customer, its employees, or subcontractors in disposing waste at this Facility. In the event Customer delivers Unacceptable Waste (as determined by Republic) Customer agrees to assume all expenses and obligations with the removal and/or resolution of any effects caused by the delivery of such Unacceptable Waste.

Indemnización. Cliente acuerda indemnizar, mantener inmune, y defender Republic Services, Inc., sus subsidiarios, compañías, divisiones, empleados, oficiales y directores contra de cualquiera y de todas responsabilidades, demandas, penas, pérdidas, juicios, pleitos y los costos incidente además, incluyendo costos de defensa, de acuerdo judicial, y de honorarios razonables del abogado, que pueden ser incurridos en, o como resultado de, la muerte o herida personal a cualquier persona, o daños a cualquier característica, propiedad, contaminación de la tierra o efectos ilícitos en esta Facilidad, causado entero o en parte por el cliente, sus empleados, o sus subcontratistas en botar basura en esta Facilidad. En el caso que el Cliente entrega, bota, basura (según lo determinado por Republic) en este Establecimiento basura inaceptable en los reglamentos de este Establecimiento, el Cliente se compromete asumir todos los costos y obligaciones con el retiro y/o la resolución de cualquier dano(s) causado por la entrega de tal basura inaceptable.



NON-HAZARDOUS WASTE MANIFEST

MANIFEST # 11815

GENERATOR INFORMATION

Generator Name: Tronox LLC
Address: P.O. Box 55
City: Henderson County: Clark
State: NV Zip: 89009
Site Location (if different): 560 W. Lake Mead
Henderson, NV 89015 (702) 592-7727

CUSTOMER/BILLING INFORMATION

Billing Name: NGE LLC c/o Northgate Environment Management
Address: 300 Frank Ogawa Plaza, Ste 510
City: Oakland County: Alameda
State: CA Zip: 94612

Table with 5 columns: Republic Services Approval #, Description of Waste, Volume/Weight, Expiration Date, Container Type. Row 1: 38251011244, Soil for disposal, 37 2/700, 12-31-2011, Tractor with Dump Trailer(s).

*Attach Additional Sheet if necessary

I hereby certify that the above-described materials are non-hazardous wastes as defined by 40 CFR 261 or any applicable state law. Further, that the above named materials are properly classified, described, packaged, marked and labeled, and are in proper condition for transportation according to the applicable regulations of the Department of Transportation.

Susan Crowley
Generator/Authorized Agent Name Signature Date Shipped

TRANSPORTER INFORMATION

Transporter Name: Las Vegas Paving DOT # 191949
Address: 4420 S. Decatur Truck Number: 192457
Las Vegas, NV 89103 Phone Number: (702) 353-4355

I certify no hazardous waste or other regulated substance was knowingly introduced to the waste while in my custody. The waste transported in this vehicle is the waste identified above, to the best of my knowledge.

Brian Brinkhoff
Name of Authorized Agent Signature Date Delivered 10-9-10

DISPOSAL SITE INFORMATION

Site Name: Apex Regional Landfill Phone No. (702) 599-5920
Address: 13550 U.S. Hwy 93 Las Vegas, NV

I hereby acknowledge receipt of the above described materials
Name (Print or Type) Signature Date Received 05 Oct 10

81 Environmental Tech
13550 N Highway 93
Las Vegas, NV 89165

Ticket Type: INBOUND INVOICE

Ticket Number: 1718
Date: 10/05/2010
Time In: 1:41 am
Time Out: 2:09 am

Customer: 001011 - NGE, LLC c/o Northgate Environ Mgmt

Vehicle/Container: 192456
Contract: Northgate Env. On Site Soils 3825 11
Comment: 3825 10 11244

Gross Weight: 126,660 LB Manual In
Tare Weight: 52,700 LB Manual Out
Net Weight: 73960 LB
Net Tons: 36.98

BOL: 11816

Origin	Yards	Material	Billing Quantity
Not Applicable	0.00 YD	SW CONTAMINATED SOIL	36.98 TN

Driver: _____



Weighmaster: _____

HOLDENS

Indemnification. Customer agrees, by signature above, to indemnify, hold harmless, and defend Republic Services, Inc., its subsidiaries, affiliates, employees, officers and directors from and against any and all liabilities, claims, penalties, forfeitures, suits and the costs and expenses incident thereto, including costs of defense, settlement, and reasonable attorney's fees, which may be incurred, as a result of death or injuries to any person, or damage to any property, contamination of or adverse effects on the environment, caused in whole or in part by the Customer, its employees, or subcontractors in disposing waste at this Facility. In the event Customer delivers Unacceptable Waste (as determined by Republic) Customer agrees to assume all expenses and obligations with the removal and/or resolution of any effects caused by the delivery of such Unacceptable Waste.

Indemnización. Cliente acuerda indemnizar, mantener inmune, y defender Republic Services, Inc., sus subsidiarios, compañías, divisiones, empleados, oficiales y directores contra de cualquiera y de todas responsabilidades, demandas, penas, pérdidas, juicios, pleitos y los costos incidente además, incluyendo costos de defensa, de acuerdo judicial, y de honorarios razonables del abogado, que pueden ser incurridos en, o como resultado de, la muerte o herida personal a cualquier persona, o daños a cualquier característica, propiedad, contaminación de la tierra o efectos ilícitos en esta Facilidad, causado entero o en parte por el cliente, sus empleados, o sus subcontratistas en botar basura en esta Facilidad. En el caso que el Cliente entrega, bota, basura (según lo determinado por Republic) en este Establecimiento basura inaceptable en los reglamentos de este Establecimiento, el Cliente se compromete asumir todos los costos y obligaciones con el retiro y/o la resolución de cualquier dano(s) causado por la entrega de tal basura inaceptable.



NON-HAZARDOUS WASTE MANIFEST

MANIFEST # 11816

GENERATOR INFORMATION

Generator Name: Tronox LLC

Address: P.O. Box 55

City: Henderson County: Clark

State: NV Zip: 89009

Site Location (if different): 560 W. Lake Mead
Henderson, NV 89015 (702) 592-7727

CUSTOMER/BILLING INFORMATION

Billing Name: NGE LLC c/o Northgate Environment Management

Address: 300 Frank Ogawa Plaza, Ste 510

City: Oakland County: Alameda

State: CA Zip: 94612

Table with 5 columns: Republic Services Approval #, Description of Waste, Volume/Weight, Expiration Date, Container Type. Row 1: 38251011244, Soil for disposal, 36.98 ton, 12-31-2011, Tractor with Dump Trailer(s).

*Attach Additional Sheet if necessary

I hereby certify that the above-described materials are non-hazardous wastes as defined by 40 CFR 261 or any applicable state law. Further, that the above named materials are properly classified, described, packaged, marked and labeled, and are in proper condition for transportation according to the applicable regulations of the Department of Transportation.

Susan Crowley (Signature)
Generator/Authorized Agent Name Signature Date Shipped

TRANSPORTER INFORMATION

Transporter Name: Las Vegas Paving

DOT # 191949

Address: 4420 S. Decatur

Truck Number: 192456

Las Vegas, NV 89103

Phone Number: (702) 353-4355

I certify no hazardous waste or other regulated substance was knowingly introduced to the waste while in my custody. The waste transported in this vehicle is the waste identified above, to the best of my knowledge.

(Signature) (Signature) 10/4/10
Name of Authorized Agent Signature Date Delivered

DISPOSAL SITE INFORMATION

Site Name: Apex Regional Landfill

Phone No. (702) 599-5920

Address: 13550 U.S. Hwy 93 Las Vegas, NV

I hereby acknowledge receipt of the above described materials

Hobson So Decatur (Signature) 05 Oct 10
Name (Print or Type) Signature Date Received

81 Environmental Tech
13550 N Highway 93
Las Vegas, NV 89165

Ticket Type: INBOUND INVOICE

Ticket Number: 1719
Date: 10/05/2010
Time In: 1:41 am
Time Out: 2:09 am

Customer: 001011 - NGE, LLC c/o Northgate Environ Mgmt

Vehicle/Container: 192460
Contract: Northgate Env. On Site Soils 3825 11
Comment: 3825 10 11244

Gross Weight: 124,560 LB Manual In
Tare Weight: 53,140 LB Manual Out
Net Weight: 71420 LB
Net Tons: 35.71

BOL: 11817

Origin	Yards	Material	Billing	Quantity
Not Applicable	0.00 YD	SW CONTAMINATED SOIL	35.71	TN

Driver:

Dirig Hainish

Weighmaster:

Sei Derch

HOLDENS

Indemnification. Customer agrees, by signature above, to indemnify, hold harmless, and defend Republic Services, Inc., its subsidiaries, affiliates, employees, officers and directors from and against any and all liabilities, claims, penalties, forfeitures, suits and the costs and expenses incident thereto, including costs of defense, settlement, and reasonable attorney's fees, which may be incurred, as a result of death or injuries to any person, or damage to any property, contamination of or adverse effects on the environment, caused in whole or in part by the Customer, its employees, or subcontractors in disposing waste at this Facility. In the event Customer delivers Unacceptable Waste (as determined by Republic) Customer agrees to assume all expenses and obligations with the removal and/or resolution of any effects caused by the delivery of such Unacceptable Waste.

Indemnización. Cliente acuerda indemnizar, mantener inmune, y defender Republic Services, Inc., sus subsidiarios, compañías, divisiones, empleados, oficiales y directores contra de cualquiera y de todas responsabilidades, demandas, penas, pérdidas, juicios, pleitos y los costos incidente además, incluyendo costos de defensa, de acuerdo judicial, y de honorarios razonables del abogado, que pueden ser incurridos en, o como resultado de, la muerte o herida personal a cualquier persona, o daños a cualquier característica, propiedad, contaminación de la tierra o efectos ilícitos en esta Facilidad, causado entero o en parte por el cliente, sus empleados, o sus subcontratistas en botar basura en esta Facilidad. En el caso que el Cliente entrega, bota, basura (según lo determinado por Republic) en este Establecimiento basura inaceptable en los reglamentos de este Establecimiento, el Cliente se compromete asumir todos los costos y obligaciones con el retiro y/o la resolución de cualquier dano(s) causado por la entrega de tal basura inaceptable.



NON-HAZARDOUS WASTE MANIFEST

MANIFEST # 11817

GENERATOR INFORMATION

Generator Name: Tronox LLC
Address: P.O. Box 55
City: Henderson County: Clark
State: NV Zip: 89009
Site Location (if different): 560 W. Lake Mead
Henderson, NV 89015 (702) 592-7727

CUSTOMER/BILLING INFORMATION

Billing Name: NGE LLC c/o Northgate Environment Management
Address: 300 Frank Ogawa Plaza, Ste 510
City: Oakland County: Alameda
State: CA Zip: 94612

Table with 5 columns: Republic Services Approval #, Description of Waste, Volume/Weight, Expiration Date, Container Type. Row 1: 38251011244, Soil for disposal, 35 7/10, 12-31-2011, Tractor with Dump Trailer(s).

*Attach Additional Sheet if necessary

I hereby certify that the above-described materials are non-hazardous wastes as defined by 40 CFR 261 or any applicable state law. Further, that the above named materials are properly classified, described, packaged, marked and labeled, and are in proper condition for transportation according to the applicable regulations of the Department of Transportation.

Susan Crowley (Signature)
Generator/Authorized Agent Name Signature Date Shipped

TRANSPORTER INFORMATION

Transporter Name: Las Vegas Paving DOT # 191949
Address: 4420 S. Decatur Truck Number: 2460
Las Vegas, NV 89103 Phone Number: (702) 353-4355

I certify no hazardous waste or other regulated substance was knowingly introduced to the waste while in my custody. The waste transported in this vehicle is the waste identified above, to the best of my knowledge.

Graig Honish (Signature) 10-4-10
Name of Authorized Agent Signature Date Delivered

DISPOSAL SITE INFORMATION

Site Name: Apex Regional Landfill Phone No. (702) 599-5920
Address: 13550 U.S. Hwy 93 Las Vegas, NV

Hollen So Derek (Signature) 05 Oct 10
Name (Print or Type) Signature Date Received

81 Environmental Tech
13550 N Highway 93
Las Vegas, NV 89165

Ticket Type: INBOUND INVOICE

Ticket Number: 1720
Date: 10/05/2010
Time In: 1:53 am
Time Out: 2:29 am

Customer: 001011 - NGE, LLC c/o Northgate Environ Mgmt

Vehicle/Container: 81494P
Contract: Northgate Env. On Site Soils 3825 11
Comment: 3825 10 11244

Gross Weight: 128,060 LB Manual In
Tare Weight: 51,020 LB Manual Out
Net Weight: 77040 LB
Net Tons: 38.52

BOL: 11818

Origin	Yards	Material	Billing Quantity
Not Applicable	0.00 YD	SW CONTAMINATED SOIL	38.52 TN

Driver: _____

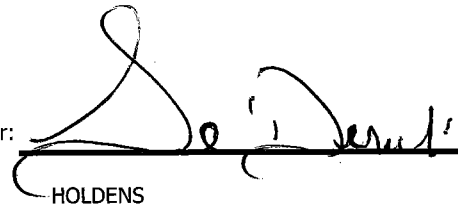

Weighmaster: _____

HOLDENS

Indemnification. Customer agrees, by signature above, to indemnify, hold harmless, and defend Republic Services, Inc., its subsidiaries, affiliates, employees, officers and directors from and against any and all liabilities, claims, penalties, forfeitures, suits and the costs and expenses incident thereto, including costs of defense, settlement, and reasonable attorney's fees, which may be incurred, as a result of death or injuries to any person, or damage to any property, contamination of or adverse effects on the environment, caused in whole or in part by the Customer, its employees, or subcontractors in disposing waste at this Facility. In the event Customer delivers Unacceptable Waste (as determined by Republic) Customer agrees to assume all expenses and obligations with the removal and/or resolution of any effects caused by the delivery of such Unacceptable Waste.

Indemnización. Cliente acuerda indemnizar, mantener inmune, y defender Republic Services, Inc., sus subsidiarios, compañías, divisiones, empleados, oficiales y directores contra de cualquiera y de todas responsabilidades, demandas, penas, pérdidas, juicios, pleitos y los costos incidente además, incluyendo costos de defensa, de acuerdo judicial, y de honorarios razonables del abogado, que pueden ser incurridos en, o como resultado de, la muerte o herida personal a cualquier persona, o daños a cualquier característica, propiedad, contaminación de la tierra o efectos ilícitos en esta Facilidad, causado entero o en parte por el cliente, sus empleados, o sus subcontratistas en botar basura en esta Facilidad. En el caso que el Cliente entrega, bota, basura (según lo determinado por Republic) en este Establecimiento basura inaceptable en los reglamentos de este Establecimiento, el Cliente se compromete asumir todos los costos y obligaciones con el retiro y/o la resolución de cualquier dano(s) causado por la entrega de tal basura inaceptable.



NON-HAZARDOUS WASTE MANIFEST

MANIFEST # 11818

GENERATOR INFORMATION

Generator Name: Tronox LLC
Address: P.O. Box 55
City: Henderson County: Clark
State: NV Zip: 89009
Site Location (if different): 560 W. Lake Mead
Henderson, NV 89015 (702) 592-7727

CUSTOMER/BILLING INFORMATION

Billing Name: NGE LLC c/o Northgate Environment Management
Address: 300 Frank Ogawa Plaza, Ste 510
City: Oakland County: Alameda
State: CA Zip: 94612

Table with 5 columns: Republic Services Approval #, Description of Waste, Volume/Weight, Expiration Date, Container Type. Row 1: 38251011244, Soil for disposal, 38 sa, 12-31-2011, Tractor with Dump Trailer(s).

*Attach Additional Sheet if necessary

I hereby certify that the above-described materials are non-hazardous wastes as defined by 40 CFR 261 or any applicable state law. Further, that the above named materials are properly classified, described, packaged, marked and labeled, and are in proper condition for transportation according to the applicable regulations of the Department of Transportation.

Susan Crowley
Generator/Authorized Agent Name Signature Date Shipped

TRANSPORTER INFORMATION

Transporter Name: Las Vegas Paving DOT # 191949
Address: 4420 S. Decatur Truck Number: 125
Las Vegas, NV 89103 Phone Number: (702) 353-4355

I certify no hazardous waste or other regulated substance was knowingly introduced to the waste while in my custody. The waste transported in this vehicle is the waste identified above, to the best of my knowledge.

Calvin Paguyo
Name of Authorized Agent Signature Date Delivered 10-04-10

DISPOSAL SITE INFORMATION

Site Name: Apex Regional Landfill Phone No. (702) 599-5920
Address: 13550 U.S. Hwy 93 Las Vegas, NV

I hereby acknowledge receipt of the above described materials
DeDerrick Holden
Name (Print or Type) Signature Date Received 05 Oct 10

81 Environmental Tech
13550 N Highway 93
Las Vegas, NV 89165

Ticket Type: INBOUND INVOICE

Ticket Number: 1721
Date: 10/05/2010
Time In: 2:13 am
Time Out: 2:35 am

Customer: 001011 - NGE, LLC c/o Northgate Environ Mgmt

Vehicle/Container: 81495P
Contract: Northgate Env. On Site Soils 3825 11
Comment: 3825 10 11244

Gross Weight: 126,680 LB Manual In
Tare Weight: 51,040 LB Manual Out
Net Weight: 75640 LB
Net Tons: 37.82

BOL: 11819

Origin	Yards	Material	Billing	Quantity
Not Applicable	0.00 YD	SW CONTAMINATED SOIL	37.82	TN

Driver:

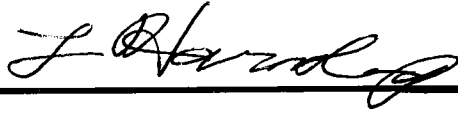

Weighmaster:

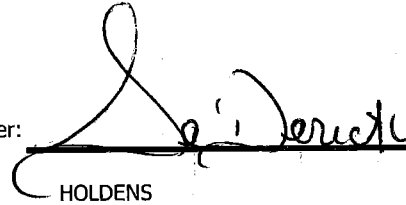

HOLDENS

Indemnification. Customer agrees, by signature above, to indemnify, hold harmless, and defend Republic Services, Inc., its subsidiaries, affiliates, employees, officers and directors from and against any and all liabilities, claims, penalties, forfeitures, suits and the costs and expenses incident thereto, including costs of defense, settlement, and reasonable attorney's fees, which may be incurred, as a result of death or injuries to any person, or damage to any property, contamination of or adverse effects on the environment, caused in whole or in part by the Customer, its employees, or subcontractors in disposing waste at this Facility. In the event Customer delivers Unacceptable Waste (as determined by Republic) Customer agrees to assume all expenses and obligations with the removal and/or resolution of any effects caused by the delivery of such Unacceptable Waste.

Indemnización. Cliente acuerda indemnizar, mantener inmune, y defender Republic Services, Inc., sus subsidiarios, compañías, divisiones, empleados, oficiales y directores contra de cualquiera y de todas responsabilidades, demandas, penas, pérdidas, juicios, pleitos y los costos incidente además, incluyendo costos de defensa, de acuerdo judicial, y de honorarios razonables del abogado, que pueden ser incurridos en, o como resultado de, la muerte o herida personal a cualquier persona, o daños a cualquier característica, propiedad, contaminación de la tierra o efectos ilícitos en esta Facilidad, causado entero o en parte por el cliente, sus empleados, o sus subcontratistas en botar basura en esta Facilidad. En el caso que el Cliente entrega, bota, basura (según lo determinado por Republic) en este Establecimiento basura inaceptable en los reglamentos de este Establecimiento, el Cliente se compromete asumir todos los costos y obligaciones con el retiro y/o la resolución de cualquier dano(s) causado por la entrega de tal basura inaceptable.



SR 4076
NON-HAZARDOUS WASTE MANIFEST

MANIFEST # 11819

GENERATOR INFORMATION

Generator Name: Tronox LLC
 Address: P.O. Box 55
 City: Henderson County: Clark
 State: NV Zip: 89009
 Site Location (if different): 560 W. Lake Mead
Henderson, NV 89015 (702) 592-7727

CUSTOMER/BILLING INFORMATION

Billing Name: NGE LLC c/o Northgate Environment Management
 Address: 300 Frank Ogawa Plaza, Ste 510
 City: Oakland County: Alameda
 State: CA Zip: 94612

Republic Services Approval #	Description of Waste	Volume/Weight	Expiration Date	Container Type
38251011244	Soil for disposal	37 ⁹² / ₁₀₀	12-31-2011	Tractor with Dump Trailer(s)
	RZ- _____ # _____			

*Attach Additional Sheet if necessary

I hereby certify that the above-described materials are non-hazardous wastes as defined by 40 CFR 261 or any applicable state law. Further, that the above named materials are properly classified, described, packaged, marked and labeled, and are in proper condition for transportation according to the applicable regulations of the Department of Transportation.

Susan Crowley *Susan Crowley*
 Generator/Authorized Agent Name Signature Date Shipped

TRANSPORTER INFORMATION

Transporter Name: Las Vegas Paving DOT # 191949
 Address: 4420 S. Decatur Truck Number: 175
Las Vegas, NV 89103 Phone Number: (702) 353-4355

I certify no hazardous waste or other regulated substance was knowingly introduced to the waste while in my custody. The waste transported in this vehicle is the waste identified above, to the best of my knowledge.

Larry Harnsberger *Larry Harnsberger* 10-4-10
 Name of Authorized Agent Signature Date Delivered

DISPOSAL SITE INFORMATION

Site Name: Apex Regional Landfill Phone No. (702) 599-5920
 Address: 13550 U.S. Hwy 93 Las Vegas, NV

I hereby acknowledge receipt of the above described materials.
Holden Se'Denic *Se'Denic Holden* 05 Oct 10
 Name (Print or Type) Signature Date Received

81 Environmental Tech
13550 N Highway 93
Las Vegas, NV 89165

Ticket Type: INBOUND INVOICE

Ticket Number: 1722
Date: 10/05/2010
Time In: 2:15 am
Time Out: 2:38 am

Customer: 001011 - NGE, LLC c/o Northgate Environ Mgmt

Vehicle/Container: 81496P
Contract: Northgate Env. On Site Soils 3825 11
Comment: 3825 10 11244

Gross Weight: 131,120 LB Manual In
Tare Weight: 50,220 LB Manual Out
Net Weight: 80900 LB
Net Tons: 40.45

BOL: 11820

Origin	Yards	Material	Billing Quantity
Not Applicable	0.00 YD	SW CONTAMINATED SOIL	40.45 TN

Driver:

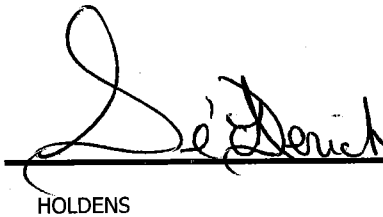

Weighmaster:

HOLDENS

Indemnification. Customer agrees, by signature above, to indemnify, hold harmless, and defend Republic Services, Inc., its subsidiaries, affiliates, employees, officers and directors from and against any and all liabilities, claims, penalties, forfeitures, suits and the costs and expenses incident thereto, including costs of defense, settlement, and reasonable attorney's fees, which may be incurred, as a result of death or injuries to any person, or damage to any property, contamination of or adverse effects on the environment, caused in whole or in part by the Customer, its employees, or subcontractors in disposing waste at this Facility. In the event Customer delivers Unacceptable Waste (as determined by Republic) Customer agrees to assume all expenses and obligations with the removal and/or resolution of any effects caused by the delivery of such Unacceptable Waste.

Indemnización. Cliente acuerda indemnizar, mantener inmune, y defender Republic Services, Inc., sus subsidiarios, compañías, divisiones, empleados, oficiales y directores contra de cualquiera y de todas responsabilidades, demandas, penas, pérdidas, juicios, pleitos y los costos incidente además, incluyendo costos de defensa, de acuerdo judicial, y de honorarios razonables del abogado, que pueden ser incurridos en, o como resultado de, la muerte o herida personal a cualquier persona, o daños a cualquier característica, propiedad, contaminación de la tierra o efectos ilícitos en esta Facilidad, causado entero o en parte por el cliente, sus empleados, o sus subcontratistas en botar basura en esta Facilidad. En el caso que el Cliente entrega, bota, basura (según lo determinado por Republic) en este Establecimiento basura inaceptable en los reglamentos de este Establecimiento, el Cliente se compromete asumir todos los costos y obligaciones con el retiro y/o la resolución de cualquier dano(s) causado por la entrega de tal basura inaceptable.



NON-HAZARDOUS WASTE MANIFEST

MANIFEST # 11820

GENERATOR INFORMATION

Generator Name: Tronox LLC
Address: P.O. Box 55
City: Henderson County: Clark
State: NV Zip: 89009
Site Location (if different): 560 W. Lake Mead
Henderson, NV 89015 (702) 592-7727

CUSTOMER/BILLING INFORMATION

Billing Name: NGE LLC c/o Northgate Environment Management
Address: 300 Frank Ogawa Plaza, Ste 510
City: Oakland County: Alameda
State: CA Zip: 94612

Table with 5 columns: Republic Services Approval #, Description of Waste, Volume/Weight, Expiration Date, Container Type. Row 1: 38251011244, Soil for disposal, 4/10 45/ton, 12-31-2011, Tractor with Dump Trailer(s).

*Attach Additional Sheet if necessary

I hereby certify that the above-described materials are non-hazardous wastes as defined by 40 CFR 261 or any applicable state law. Further, that the above named materials are properly classified, described, packaged, marked and labeled, and are in proper condition for transportation according to the applicable regulations of the Department of Transportation.

Susan Crowley
Generator/Authorized Agent Name Signature Date Shipped

TRANSPORTER INFORMATION

Transporter Name: Las Vegas Paving DOT # 191949
Address: 4420 S. Decatur Truck Number: 145
Las Vegas, NV 89103 Phone Number: (702) 353-4355

I certify no hazardous waste or other regulated substance was knowingly introduced to the waste while in my custody. The waste transported in this vehicle is the waste identified above, to the best of my knowledge.

Harry M Seal
Name of Authorized Agent Signature Date Delivered 10-4-10

DISPOSAL SITE INFORMATION

Site Name: Apex Regional Landfill Phone No. (702) 599-5920
Address: 13550 U.S. Hwy 93 Las Vegas, NV

I hereby acknowledge receipt of the above described materials

Holden, Se...
Name (Print or Type) Signature Date Received 05 Oct 10

81 Environmental Tech
13550 N Highway 93
Las Vegas, NV 89165

Ticket Type: INBOUND INVOICE

Ticket Number: 1723
Date: 10/05/2010
Time In: 2:27 am
Time Out: 2:49 am

Customer: 001011 - NGE, LLC c/o Northgate Environ Mgmt

Vehicle/Container: 81460P
Contract: Northgate Env. On Site Soils 3825 11
Comment: 3825 10 11244

Gross Weight: 132,240 LB Manual In
Tare Weight: 52,220 LB Manual Out
Net Weight: 80020 LB
Net Tons: 40.01

BOL: 11821

Origin	Yards	Material	Billing Quantity
Not Applicable	0.00 YD	SW CONTAMINATED SOIL	40.01 TN

Driver: _____

Weighmaster: _____

HOLDENS

Indemnification. Customer agrees, by signature above, to indemnify, hold harmless, and defend Republic Services, Inc., its subsidiaries, affiliates, employees, officers and directors from and against any and all liabilities, claims, penalties, forfeitures, suits and the costs and expenses incident thereto, including costs of defense, settlement, and reasonable attorney's fees, which may be incurred, as a result of death or injuries to any person, or damage to any property, contamination of or adverse effects on the environment, caused in whole or in part by the Customer, its employees, or subcontractors in disposing waste at this Facility. In the event Customer delivers Unacceptable Waste (as determined by Republic) Customer agrees to assume all expenses and obligations with the removal and/or resolution of any effects caused by the delivery of such Unacceptable Waste.

Indemnización. Cliente acuerda indemnizar, mantener inmune, y defender Republic Services, Inc., sus subsidiarios, compañías, divisiones, empleados, oficiales y directores contra de cualquiera y de todas responsabilidades, demandas, penas, pérdidas, juicios, pleitos y los costos incidente además, incluyendo costos de defensa, de acuerdo judicial, y de honorarios razonables del abogado, que pueden ser incurridos en, o como resultado de, la muerte o herida personal a cualquier persona, o daños a cualquier característica, propiedad, contaminación de la tierra o efectos ilícitos en esta Facilidad, causado entero o en parte por el cliente, sus empleados, o sus subcontratistas en botar basura en esta Facilidad. En el caso que el Cliente entrega, bota, basura (según lo determinado por Republic) en este Establecimiento, basura inaceptable en los reglamentos de este Establecimiento, el Cliente se compromete asumir todos los costos y obligaciones con el retiro y/o la resolución de cualquier dano(s) causado por la entrega de tal basura inaceptable.



NON-HAZARDOUS WASTE MANIFEST

MANIFEST # 11821

GENERATOR INFORMATION

Generator Name: Tronox LLC
Address: P.O. Box 55
City: Henderson County: Clark
State: NV Zip: 89009
Site Location (if different): 560 W. Lake Mead
Henderson, NV 89015 (702) 592-7727

CUSTOMER/BILLING INFORMATION

Billing Name: NGE LLC c/o Northgate Environment Management
Address: 300 Frank Ogawa Plaza, Ste 510
City: Oakland County: Alameda
State: CA Zip: 94612

Table with 5 columns: Republic Services Approval #, Description of Waste, Volume/Weight, Expiration Date, Container Type. Row 1: 38251011244, Soil for disposal, $10 \frac{qt}{ton}$, 12-31-2011, Tractor with Dump Trailer(s). Row 2: RZ- #

*Attach Additional Sheet if necessary

I hereby certify that the above-described materials are non-hazardous wastes as defined by 40 CFR 261 or any applicable state law. Further, that the above named materials are properly classified, described, packaged, marked and labeled, and are in proper condition for transportation according to the applicable regulations of the Department of Transportation.

Susan Crowley
Generator/Authorized Agent Name Signature Date Shipped

TRANSPORTER INFORMATION

Transporter Name: Las Vegas Paving DOT # 191949
Address: 4420 S. Decatur Truck Number: 27
Las Vegas, NV 89103 Phone Number: (702) 353-4355

I certify no hazardous waste or other regulated substance was knowingly introduced to the waste while in my custody. The waste transported in this vehicle is the waste identified above, to the best of my knowledge.

Daniel Cardenas
Name of Authorized Agent Signature Date Delivered 10-4-2010

DISPOSAL SITE INFORMATION

Site Name: Apex Regional Landfill Phone No. (702) 599-5920
Address: 13550 U.S. Hwy 93 Las Vegas, NV

I hereby acknowledge receipt of the above described materials
Name (Print or Type) Signature Date Received 05 Oct 10

81 Environmental Tech
13550 N Highway 93
Las Vegas, NV 89165

Ticket Type: INBOUND INVOICE

Ticket Number: 1724
Date: 10/05/2010
Time In: 2:29 am
Time Out: 2:50 am

Customer: 001011 - NGE, LLC c/o Northgate Environ Mgmt

Vehicle/Container: 84598P
Contract: Northgate Env. On Site Soils 3825 11
Comment: 3825 10 11244

Gross Weight: 133,960 LB Manual In
Tare Weight: 51,840 LB Manual Out
Net Weight: 82120 LB
Net Tons: 41.06

BOL: 11822

Origin	Yards	Material	Billing Quantity
Not Applicable	0.00 YD	SW CONTAMINATED SOIL	41.06 TN

Driver:

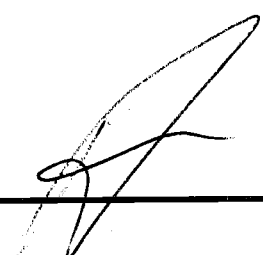

Weighmaster:

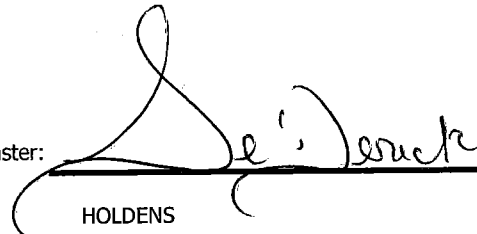

HOLDENS

Indemnification. Customer agrees, by signature above, to indemnify, hold harmless, and defend Republic Services, Inc., its subsidiaries, affiliates, employees, officers and directors from and against any and all liabilities, claims, penalties, forfeitures, suits and the costs and expenses incident thereto, including costs of defense, settlement, and reasonable attorney's fees, which may be incurred, as a result of death or injuries to any person, or damage to any property, contamination of or adverse effects on the environment, caused in whole or in part by the Customer, its employees, or subcontractors in disposing waste at this Facility. In the event Customer delivers Unacceptable Waste (as determined by Republic) Customer agrees to assume all expenses and obligations with the removal and/or resolution of any effects caused by the delivery of such Unacceptable Waste.

Indemnización. Cliente acuerda indemnizar, mantener inmune, y defender Republic Services, Inc., sus subsidiarios, compañías, divisiones, empleados, oficiales y directores contra de cualquiera y de todas responsabilidades, demandas, penas, pérdidas, juicios, pleitos y los costos incidente además, incluyendo costos de defensa, de acuerdo judicial, y de honorarios razonables del abogado, que pueden ser incurridos en, o como resultado de, la muerte o herida personal a cualquier persona, o daños a cualquier característica, propiedad, contaminación de la tierra o efectos ilícitos en esta Facilidat, causado entero o en parte por el cliente, sus empleados, o sus subcontratistas en botar basura en esta Facilidat. En el caso que el Cliente entrega, bota, basura (según lo determinado por Republic) en este Establecimiento basura inaceptable en los reglamentos de este Establecimiento, el Cliente se compromete asumir todos los costos y obligaciones con el retiro y/o la resolución de cualquier dano(s) causado por la entrega de tal basura inaceptable.



NON-HAZARDOUS WASTE MANIFEST

MANIFEST # 11822

GENERATOR INFORMATION

Generator Name: Tronox LLC
Address: P.O. Box 55
City: Henderson County: Clark
State: NV Zip: 89009
Site Location (if different): 560 W. Lake Mead
Henderson, NV 89015 (702) 592-7727

CUSTOMER/BILLING INFORMATION

Billing Name: NGE LLC c/o Northgate Environment Management
Address: 300 Frank Ogawa Plaza, Ste 510
City: Oakland County: Alameda
State: CA Zip: 94612

Table with 5 columns: Republic Services Approval #, Description of Waste, Volume/Weight, Expiration Date, Container Type. Row 1: 38251011244, Soil for disposal, 41 26/107, 12-31-2011, Tractor with Dump Trailer(s)

*Attach Additional Sheet if necessary

I hereby certify that the above-described materials are non-hazardous wastes as defined by 40 CFR 261 or any applicable state law. Further, that the above named materials are properly classified, described, packaged, marked and labeled, and are in proper condition for transportation according to the applicable regulations of the Department of Transportation.

Susan Crowley (Signature)
Generator/Authorized Agent Name Signature Date Shipped

TRANSPORTER INFORMATION

Transporter Name: Las Vegas Paving DOT # 191949
Address: 4420 S. Decatur Truck Number: 28
Las Vegas, NV 89103 Phone Number: (702) 353-4355

I certify no hazardous waste or other regulated substance was knowingly introduced to the waste while in my custody. The waste transported in this vehicle is the waste identified above, to the best of my knowledge.

KRANC (Signature)
Name of Authorized Agent Signature Date Delivered 10-5-10

DISPOSAL SITE INFORMATION

Site Name: Apex Regional Landfill Phone No. (702) 599-5920
Address: 13550 U.S. Hwy 93 Las Vegas, NV

I hereby acknowledge receipt of the above described materials
Holden, Se'Dorrell (Signature)
Name (Print or Type) Signature Date Received 05 Oct 10

81 Environmental Tech
13550 N Highway 93
Las Vegas, NV 89165

Ticket Type: INBOUND INVOICE

Ticket Number: 1725
Date: 10/05/2010
Time In: 2:42 am
Time Out: 3:05 am

Customer: 001011 - NGE, LLC c/o Northgate Environ Mgmt

Vehicle/Container: 86053P
Contract: Northgate Env. On Site Soils 3825 11
Comment: 3825 10 11244

Gross Weight: 131,720 LB Manual In
Tare Weight: 54,620 LB Manual Out
Net Weight: 77100 LB
Net Tons: 38.55

BOL: 11825

Origin	Yards	Material	Billing Quantity
Not Applicable	0.00 YD	SW CONTAMINATED SOIL	38.55 TN

Driver: _____

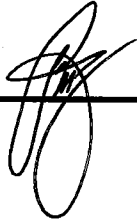

Weighmaster: _____

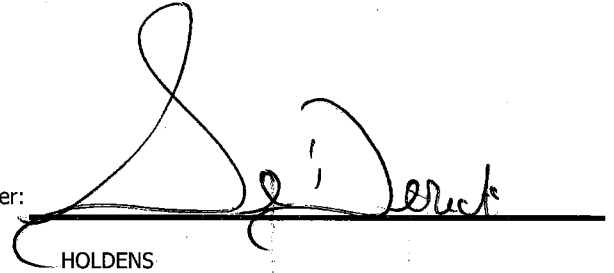

HOLDENS

Indemnification. Customer agrees, by signature above, to indemnify, hold harmless, and defend Republic Services, Inc., its subsidiaries, affiliates, employees, officers and directors from and against any and all liabilities, claims, penalties, forfeitures, suits and the costs and expenses incident thereto, including costs of defense, settlement, and reasonable attorney's fees, which may be incurred, as a result of death or injuries to any person, or damage to any property, contamination of or adverse effects on the environment, caused in whole or in part by the Customer, its employees, or subcontractors in disposing waste at this Facility. In the event Customer delivers Unacceptable Waste (as determined by Republic) Customer agrees to assume all expenses and obligations with the removal and/or resolution of any effects caused by the delivery of such Unacceptable Waste.

Indemnización. Cliente acuerda indemnizar, mantener inmune, y defender Republic Services, Inc., sus subsidiarios, compañías, divisiones, empleados, oficiales y directores contra de cualquiera y de todas responsabilidades, demandas, penas, pérdidas, juicios, pleitos y los costos incidente además, incluyendo costos de defensa, de acuerdo judicial, y de honorarios razonables del abogado, que pueden ser incurridos en, o como resultado de, la muerte o herida personal a cualquier persona, o daños a cualquier característica, propiedad, contaminación de la tierra o efectos ilícitos en esta Facilidad, causado entero o en parte por el cliente, sus empleados, o sus subcontratistas en botar basura en esta Facilidad. En el caso que el Cliente entrega, bota, basura (según lo determinado por Republic) en este Establecimiento basura inaceptable en los reglamentos de este Establecimiento, el Cliente se compromete asumir todos los costos y obligaciones con el retiro y/o la resolución de cualquier dano(s) causado por la entrega de tal basura inaceptable.



NON-HAZARDOUS WASTE MANIFEST

MANIFEST # 11825

GENERATOR INFORMATION

Generator Name: Tronox LLC
Address: P.O. Box 55
City: Henderson County: Clark
State: NV Zip: 89009
Site Location (if different): 560 W. Lake Mead
Henderson, NV 89015 (702) 592-7727

CUSTOMER/BILLING INFORMATION

Billing Name: NGE LLC c/o Northgate Environment Management
Address: 300 Frank Ogawa Plaza, Ste 510
City: Oakland County: Alameda
State: CA Zip: 94612

Table with 5 columns: Republic Services Approval #, Description of Waste, Volume/Weight, Expiration Date, Container Type. Row 1: 38251011244, Soil for disposal, 39 25/70n, 12-31-2011, Tractor with Dump Trailer(s). Row 2: RZ- #

*Attach Additional Sheet if necessary

I hereby certify that the above-described materials are non-hazardous wastes as defined by 40 CFR 261 or any applicable state law. Further, that the above named materials are properly classified, described, packaged, marked and labeled, and are in proper condition for transportation according to the applicable regulations of the Department of Transportation.

Susan Crowley
Generator/Authorized Agent Name Signature Date Shipped

TRANSPORTER INFORMATION

Transporter Name: Las Vegas Paving DOT # 191949
Address: 4420 S. Decatur Truck Number: 261
Las Vegas, NV 89103 Phone Number: (702) 353-4355

I certify no hazardous waste or other regulated substance was knowingly introduced to the waste while in my custody. The waste transported in this vehicle is the waste identified above, to the best of my knowledge.

Name of Authorized Agent Signature Date Delivered
Patrick Jones 4 OCT 10

DISPOSAL SITE INFORMATION

Site Name: Apex Regional Landfill Phone No. (702) 599-5920
Address: 13550 U.S. Hwy 93 Las Vegas, NV

I hereby acknowledge receipt of the above described materials
Name (Print or Type) Signature Date Received
Holden, Se Derrick Holden 05 Oct 10

81 Environmental Tech
13550 N Highway 93
Las Vegas, NV 89165

Ticket Type: INBOUND INVOICE

Ticket Number: 1726
Date: 10/05/2010
Time In: 2:58 am
Time Out: 3:20 am

Customer: 001011 - NGE, LLC c/o Northgate Environ Mgmt

Vehicle/Container: 76810P
Contract: Northgate Env. On Site Soils 3825 11
Comment: 3825 10 11244

Gross Weight: 129,680 LB Manual In
Tare Weight: 54,640 LB Manual Out
Net Weight: 75040 LB
Net Tons: 37.52

BOL: 11823

Origin	Yards	Material	Billing	Quantity
Not Applicable	0.00 YD	SW CONTAMINATED SOIL	37.52	TN

Driver:

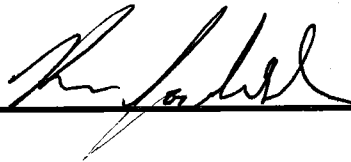

Weighmaster:

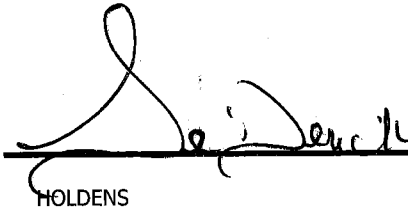
HOLDENS

Indemnification. Customer agrees, by signature above, to indemnify, hold harmless, and defend Republic Services, Inc., its subsidiaries, affiliates, employees, officers and directors from and against any and all liabilities, claims, penalties, forfeitures, suits and the costs and expenses incident thereto, including costs of defense, settlement, and reasonable attorney's fees, which may be incurred, as a result of death or injuries to any person, or damage to any property, contamination of or adverse effects on the environment, caused in whole or in part by the Customer, its employees, or subcontractors in disposing waste at this Facility. In the event Customer delivers Unacceptable Waste (as determined by Republic) Customer agrees to assume all expenses and obligations with the removal and/or resolution of any effects caused by the delivery of such Unacceptable Waste.

Indemnización. Cliente acuerda indemnizar, mantener inmune, y defender Republic Services, Inc., sus subsidiarios, compañías, divisiones, empleados, oficiales y directores contra de cualquiera y de todas responsabilidades, demandas, penas, pérdidas, juicios, pleitos y los costos incidente además, incluyendo costos de defensa, de acuerdo judicial, y de honorarios razonables del abogado, que pueden ser incurridos en, o como resultado de, la muerte o herida personal a cualquier persona, o daños a cualquier característica, propiedad, contaminación de la tierra o efectos ilícitos en esta Facilidad, causado entero o en parte por el cliente, sus empleados, o sus subcontratistas en botar basura en esta Facilidad. En el caso que el Cliente entrega, bota, basura (según lo determinado por Republic) en este Establecimiento basura inaceptable en los reglamentos de este Establecimiento, el Cliente se compromete asumir todos los costos y obligaciones con el retiro y/o la resolución de cualquier dano(s) causado por la entrega de tal basura inaceptable.



NON-HAZARDOUS WASTE MANIFEST

MANIFEST # 11823

GENERATOR INFORMATION

Generator Name: Tronox LLC
Address: P.O. Box 55
City: Henderson County: Clark
State: NV Zip: 89009
Site Location (if different): 560 W. Lake Mead
Henderson, NV 89015 (702) 592-7727

CUSTOMER/BILLING INFORMATION

Billing Name: NGE LLC c/o Northgate Environment Management
Address: 300 Frank Ogawa Plaza, Ste 510
City: Oakland County: Alameda
State: CA Zip: 94612

Table with 5 columns: Republic Services Approval #, Description of Waste, Volume/Weight, Expiration Date, Container Type. Row 1: 38251011244, Soil for disposal, 37 tons, 12-31-2011, Tractor with Dump Trailer(s).

*Attach Additional Sheet if necessary

I hereby certify that the above-described materials are non-hazardous wastes as defined by 40 CFR 261 or any applicable state law. Further, that the above named materials are properly classified, described, packaged, marked and labeled, and are in proper condition for transportation according to the applicable regulations of the Department of Transportation.

Susan Crowley (Signature)
Generator/Authorized Agent Name Signature Date Shipped

TRANSPORTER INFORMATION

Transporter Name: Las Vegas Paving DOT # 191949
Address: 4420 S. Decatur Truck Number: 241
Las Vegas, NV 89103 Phone Number: (702) 353-4355

I certify no hazardous waste or other regulated substance was knowingly introduced to the waste while in my custody. The waste transported in this vehicle is the waste identified above, to the best of my knowledge.

Ken Jackstan (Signature)
Name of Authorized Agent Signature Date Delivered 10-4-2010

DISPOSAL SITE INFORMATION

Site Name: Apex Regional Landfill Phone No. (702) 599-5920
Address: 13550 U.S. Hwy 93 Las Vegas, NV

I hereby acknowledge receipt of the above described materials
Holder, Se Small (Signature)
Name (Print or Type) Signature Date Received 05 Oct 10

81 Environmental Tech
13550 N Highway 93
Las Vegas, NV 89165

Ticket Type: INBOUND INVOICE

Ticket Number: 1727
Date: 10/05/2010
Time In: 2:56 am
Time Out: 3:22 am

Customer: 001011 - NGE, LLC c/o Northgate Environ Mgmt

Vehicle/Container: 82418P
Contract: Northgate Env. On Site Soils 3825 11
Comment: 3825 10 11244

Gross Weight: 141,320 LB Manual In
Tare Weight: 66,460 LB Manual Out
Net Weight: 74860 LB
Net Tons: 37.43

BOL: 11824

Origin	Yards	Material	Billing	Quantity
Not Applicable	0.00 YD	SW CONTAMINATED SOIL	37.43	TN

Driver:

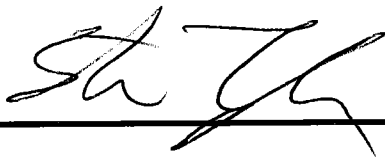

Weighmaster:

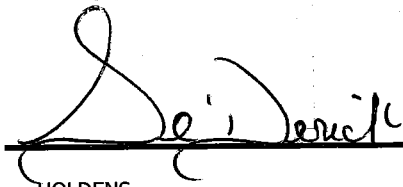

HOLDENS

Indemnification. Customer agrees, by signature above, to indemnify, hold harmless, and defend Republic Services, Inc., its subsidiaries, affiliates, employees, officers and directors from and against any and all liabilities, claims, penalties, forfeitures, suits and the costs and expenses incident thereto, including costs of defense, settlement, and reasonable attorney's fees, which may be incurred, as a result of death or injuries to any person, or damage to any property, contamination of or adverse effects on the environment, caused in whole or in part by the Customer, its employees, or subcontractors in disposing waste at this Facility. In the event Customer delivers Unacceptable Waste (as determined by Republic) Customer agrees to assume all expenses and obligations with the removal and/or resolution of any effects caused by the delivery of such Unacceptable Waste.

Indemnización. Cliente acuerda indemnizar, mantener inmune, y defender Republic Services, Inc., sus subsidiarios, compañías, divisiones, empleados, oficiales y directores contra de cualquiera y de todas responsabilidades, demandas, penas, pérdidas, juicios, pleitos y los costos incidente además, incluyendo costos de defensa, de acuerdo judicial, y de honorarios razonables del abogado, que pueden ser incurridos en, o como resultado de, la muerte o herida personal a cualquier persona, o daños a cualquier característica, propiedad, contaminación de la tierra o efectos ilícitos en esta Facilidad, causado entero o en parte por el cliente, sus empleados, o sus subcontratistas en botar basura en esta Facilidad. En el caso que el Cliente entrega, bota, basura (según lo determinado por Republic) en este Establecimiento basura inaceptable en los reglamentos de este Establecimiento, el Cliente se compromete asumir todos los costos y obligaciones con el retiro y/o la resolución de cualquier dano(s) causado por la entrega de tal basura inaceptable.



NON-HAZARDOUS WASTE MANIFEST

MANIFEST # 11824

GENERATOR INFORMATION

Generator Name: Tronox LLC
Address: P.O. Box 55
City: Henderson County: Clark
State: NV Zip: 89009
Site Location (if different): 560 W. Lake Mead
Henderson, NV 89015 (702) 592-7727

CUSTOMER/BILLING INFORMATION

Billing Name: NGE LLC c/o Northgate Environment Management
Address: 300 Frank Ogawa Plaza, Ste 510
City: Oakland County: Alameda
State: CA Zip: 94612

Table with 5 columns: Republic Services Approval #, Description of Waste, Volume/Weight, Expiration Date, Container Type. Row 1: 38251011244, Soil for disposal, 37 43/100, 12-31-2011, Tractor with Dump Trailer(s).

*Attach Additional Sheet if necessary

I hereby certify that the above-described materials are non-hazardous wastes as defined by 40 CFR 261 or any applicable state law. Further, that the above named materials are properly classified, described, packaged, marked and labeled, and are in proper condition for transportation according to the applicable regulations of the Department of Transportation.

Susan Crowley (Signature)
Generator/Authorized Agent Name Signature Date Shipped

TRANSPORTER INFORMATION

Transporter Name: Las Vegas Paving DOT # 191949
Address: 4420 S. Decatur Truck Number: 220
Las Vegas, NV 89103 Phone Number: (702) 353-4355

I certify no hazardous waste or other regulated substance was knowingly introduced to the waste while in my custody. The waste transported in this vehicle is the waste identified above, to the best of my knowledge.

STEVE TAYLOR (Signature)
Name of Authorized Agent Signature Date Delivered 10-4-10

DISPOSAL SITE INFORMATION

Site Name: Apex Regional Landfill Phone No. (702) 599-5920
Address: 13550 U.S. Hwy 93 Las Vegas, NV

I hereby acknowledge receipt of the above described materials
Holden, Se' Derrick (Signature)
Name (Print or Type) Signature Date Received 05 Oct 10

81 Environmental Tech
13550 N Highway 93
Las Vegas, NV 89165

Ticket Type: INBOUND INVOICE

Ticket Number: 1728
Date: 10/05/2010
Time In: 2:58 am
Time Out: 3:28 am

Customer: 001011 - NGE, LLC c/o Northgate Environ Mgmt

Vehicle/Container: 44564A
Contract: Northgate Env. On Site Soils 3825 11
Comment: 3825 10 11244

Gross Weight: 129,580 LB Manual In
Tare Weight: 48,980 LB Manual Out
Net Weight: 80600 LB
Net Tons: 40.30

BOL: 11826

Origin	Yards	Material	Billing	Quantity
Not Applicable	0.00 YD	SW CONTAMINATED SOIL	40.30	TN

Driver:

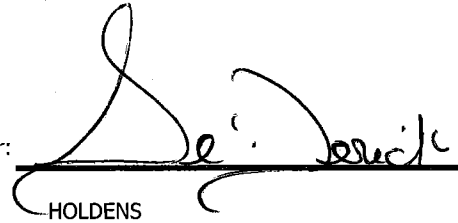

Weighmaster:

HOLDENS

Indemnification. Customer agrees, by signature above, to indemnify, hold harmless, and defend Republic Services, Inc., its subsidiaries, affiliates, employees, officers and directors from and against any and all liabilities, claims, penalties, forfeitures, suits and the costs and expenses incident thereto, including costs of defense, settlement, and reasonable attorney's fees, which may be incurred, as a result of death or injuries to any person, or damage to any property, contamination of or adverse effects on the environment, caused in whole or in part by the Customer, its employees, or subcontractors in disposing waste at this Facility. In the event Customer delivers Unacceptable Waste (as determined by Republic) Customer agrees to assume all expenses and obligations with the removal and/or resolution of any effects caused by the delivery of such Unacceptable Waste.

Indemnización. Cliente acuerda indemnizar, mantener inmune, y defender Republic Services, Inc., sus subsidiarios, compañías, divisiones, empleados, oficiales y directores contra de cualquiera y de todas responsabilidades, demandas, penas, pérdidas, juicios, pleitos y los costos incidente además, incluyendo costos de defensa, de acuerdo judicial, y de honorarios razonables del abogado, que pueden ser incurridos en, o como resultado de, la muerte o herida personal a cualquier persona, o daños a cualquier característica, propiedad, contaminación de la tierra o efectos ilícitos en esta Facilidad, causado entero o en parte por el cliente, sus empleados, o sus subcontratistas en botar basura en esta Facilidad. En el caso que el Cliente entrega, bota, basura (según lo determinado por Republic) en este Establecimiento basura inaceptable en los reglamentos de este Establecimiento, el Cliente se compromete asumir todos los costos y obligaciones con el retiro y/o la resolución de cualquier dano(s) causado por la entrega de tal basura inaceptable.



NON-HAZARDOUS WASTE MANIFEST

MANIFEST # 11826

GENERATOR INFORMATION

Generator Name: Tronox LLC

Address: P.O. Box 55

City: Henderson County: Clark

State: NV Zip: 89009

Site Location (if different): 560 W. Lake Mead

Henderson, NV 89015 (702) 592-7727

CUSTOMER/BILLING INFORMATION

Billing Name: NGE LLC c/o Northgate Environment Management

Address: 300 Frank Ogawa Plaza, Ste 510

City: Oakland County: Alameda

State: CA Zip: 94612

Republic Services Approval #	Description of Waste	Volume/Weight	Expiration Date	Container Type
38251011244	Soil for disposal	410 ³⁰ / _{ton}	12-31-2011	Tractor with Dump Trailer(s)
	RZ- #			

*Attach Additional Sheet if necessary

I hereby certify that the above-described materials are non-hazardous wastes as defined by 40 CFR 261 or any applicable state law. Further, that the above named materials are properly classified, described, packaged, marked and labeled, and are in proper condition for transportation according to the applicable regulations of the Department of Transportation.

Susan Crowley (Signature)
Generator/Authorized Agent Name Signature Date Shipped

TRANSPORTER INFORMATION

Transporter Name: Las Vegas Paving

DOT # 191949

Address: 4420 S. Decatur

Truck Number: K003

Las Vegas, NV 89103

Phone Number: (702) 353-4355

I certify no hazardous waste or other regulated substance was knowingly introduced to the waste while in my custody. The waste transported in this vehicle is the waste identified above, to the best of my knowledge.

Asencio (Signature)
Name of Authorized Agent Signature Date Delivered 10/04/10

DISPOSAL SITE INFORMATION

Site Name: Apex Regional Landfill

Phone No. (702) 599-5920

Address: 13550 U.S. Hwy 93 Las Vegas, NV

I hereby acknowledge receipt of the above described materials

Holden, Sr. Dennis (Signature)
Name (Print or Type) Signature Date Received 05 Oct 10

81 Environmental Tech
13550 N Highway 93
Las Vegas, NV 89165

Ticket Type: INBOUND INVOICE

Ticket Number: 1729
Date: 10/05/2010
Time In: 3:02 am
Time Out: 3:30 am

Customer: 001011 - NGE, LLC c/o Northgate Environ Mgmt

Vehicle/Container: 68263P
Contract: Northgate Env. On Site Soils 3825 11
Comment: 3825 10 11244

Gross Weight: 129,640 LB Manual In
Tare Weight: 53,440 LB Manual Out
Net Weight: 76200 LB
Net Tons: 38.10

BOL: 11827

Origin	Yards	Material	Billing	Quantity
Not Applicable	0.00 YD	SW CONTAMINATED SOIL	38.10	TN

Driver:

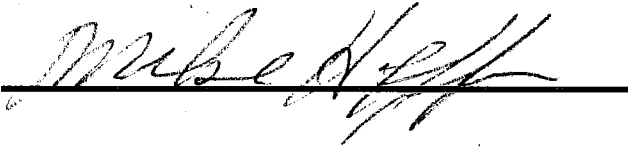

Weighmaster:

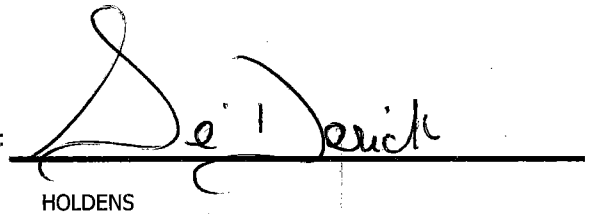

HOLDENS

Indemnification. Customer agrees, by signature above, to indemnify, hold harmless, and defend Republic Services, Inc., its subsidiaries, affiliates, employees, officers and directors from and against any and all liabilities, claims, penalties, forfeitures, suits and the costs and expenses incident thereto, including costs of defense, settlement, and reasonable attorney's fees, which may be incurred, as a result of death or injuries to any person, or damage to any property, contamination of or adverse effects on the environment, caused in whole or in part by the Customer, its employees, or subcontractors in disposing waste at this Facility. In the event Customer delivers Unacceptable Waste (as determined by Republic) Customer agrees to assume all expenses and obligations with the removal and/or resolution of any effects caused by the delivery of such Unacceptable Waste.

Indemnización. Cliente acuerda indemnizar, mantener inmune, y defender Republic Services, Inc., sus subsidiarios, compañías, divisiones, empleados, oficiales y directores contra de cualquiera y de todas responsabilidades, demandas, penas, pérdidas, juicios, pleitos y los costos incidente además, incluyendo costos de defensa, de acuerdo judicial, y de honorarios razonables del abogado, que pueden ser incurridos en, o como resultado de, la muerte o herida personal a cualquier persona, o daños a cualquier característica, propiedad, contaminación de la tierra o efectos ilícitos en esta Facilidad, causado entero o en parte por el cliente, sus empleados, o sus subcontratistas en botar basura en esta Facilidad. En el caso que el Cliente entrega, bota, basura (según lo determinado por Republic) en este Establecimiento basura inaceptable en los reglamentos de este Establecimiento, el Cliente se compromete asumir todos los costos y obligaciones con el retiro y/o la resolución de cualquier dano(s) causado por la entrega de tal basura inaceptable.



NON-HAZARDOUS WASTE MANIFEST

MANIFEST # 11827

GENERATOR INFORMATION

Generator Name: Tronox LLC
Address: P.O. Box 55
City: Henderson County: Clark
State: NV Zip: 89009
Site Location (if different): 560 W. Lake Mead
Henderson, NV 89015 (702) 592-7727

CUSTOMER/BILLING INFORMATION

Billing Name: NGE LLC c/o Northgate Environment Management
Address: 300 Frank Ogawa Plaza, Ste 510
City: Oakland County: Alameda
State: CA Zip: 94612

Table with 5 columns: Republic Services Approval #, Description of Waste, Volume/Weight, Expiration Date, Container Type. Row 1: 38251011244, Soil for disposal, 38 tons, 12-31-2011, Tractor with Dump Trailer(s).

*Attach Additional Sheet if necessary

I hereby certify that the above-described materials are non-hazardous wastes as defined by 40 CFR 261 or any applicable state law. Further, that the above named materials are properly classified, described, packaged, marked and labeled, and are in proper condition for transportation according to the applicable regulations of the Department of Transportation.

Susan Crowley
Generator/Authorized Agent Name Signature Date Shipped

TRANSPORTER INFORMATION

Transporter Name: Las Vegas Paving DOT # 191949
Address: 4420 S. Decatur Truck Number: 2711
Las Vegas, NV 89103 Phone Number: (702) 353-4355

I certify no hazardous waste or other regulated substance was knowingly introduced to the waste while in my custody. The waste transported in this vehicle is the waste identified above, to the best of my knowledge.

Mike Heffer
Name of Authorized Agent Signature Date Delivered

DISPOSAL SITE INFORMATION

Site Name: Apex Regional Landfill Phone No. (702) 599-5920
Address: 13550 U.S. Hwy 93 Las Vegas, NV

I hereby acknowledge receipt of the above described materials
Name (Print or Type) Signature Date Received

81 Environmental Tech
13550 N Highway 93
Las Vegas, NV 89165

Ticket Type: INBOUND INVOICE

Ticket Number: 1730
Date: 10/05/2010
Time In: 3:23 am
Time Out: 3:46 am

Customer: 001011 - NGE, LLC c/o Northgate Environ Mgmt

Vehicle/Container: 86113P
Contract: Northgate Env. On Site Soils 3825 11
Comment: 3825 10 11244

Gross Weight: 137,660 LB Manual In
Tare Weight: 55,200 LB Manual Out
Net Weight: 82460 LB
Net Tons: 41.23

BOL: 11828

Origin	Yards	Material	Billing Quantity
Not Applicable	0.00 YD	SW CONTAMINATED SOIL	41.23 TN

Driver:

J. A. H.

Weighmaster:

[Signature]
HOLDENS

Indemnification. Customer agrees, by signature above, to indemnify, hold harmless, and defend Republic Services, Inc., its subsidiaries, affiliates, employees, officers and directors from and against any and all liabilities, claims, penalties, forfeitures, suits and the costs and expenses incident thereto, including costs of defense, settlement, and reasonable attorney's fees, which may be incurred, as a result of death or injuries to any person, or damage to any property, contamination of or adverse effects on the environment, caused in whole or in part by the Customer, its employees, or subcontractors in disposing waste at this Facility. In the event Customer delivers Unacceptable Waste (as determined by Republic) Customer agrees to assume all expenses and obligations with the removal and/or resolution of any effects caused by the delivery of such Unacceptable Waste.

Indemnización. Cliente acuerda indemnizar, mantener inmune, y defender Republic Services, Inc., sus subsidiarios, compañías, divisiones, empleados, oficiales y directores contra de cualquiera y de todas responsabilidades, demandas, penas, pérdidas, juicios, pleitos y los costos incidente además, incluyendo costos de defensa, de acuerdo judicial, y de honorarios razonables del abogado, que pueden ser incurridos en, o como resultado de, la muerte o herida personal a cualquier persona, o daños a cualquier característica, propiedad, contaminación de la tierra o efectos ilícitos en esta Facilidad, causado entero o en parte por el cliente, sus empleados, o sus subcontratistas en botar basura en esta Facilidad. En el caso que el Cliente entrega, bota, basura (según lo determinado por Republic) en este Establecimiento basura inaceptable en los reglamentos de este Establecimiento, el Cliente se compromete asumir todos los costos y obligaciones con el retiro y/o la resolución de cualquier dano(s) causado por la entrega de tal basura inaceptable.



NON-HAZARDOUS WASTE MANIFEST

MANIFEST # 11828

GENERATOR INFORMATION

Generator Name: Tronox LLC

Address: P.O. Box 55

City: Henderson County: Clark

State: NV Zip: 89009

Site Location (if different): 560 W. Lake Mead

Henderson, NV 89015 (702) 592-7727

CUSTOMER/BILLING INFORMATION

Billing Name: NGE LLC c/o Northgate Environment Management

Address: 300 Frank Ogawa Plaza, Ste 510

City: Oakland County: Alameda

State: CA Zip: 94612

Republic Services Approval #	Description of Waste	Volume/Weight	Expiration Date	Container Type
38251011244	Soil for disposal	4/1 23/100	12-31-2011	Tractor with Dump Trailer(s)
	RZ- #			

*Attach Additional Sheet if necessary

I hereby certify that the above-described materials are non-hazardous wastes as defined by 40 CFR 261 or any applicable state law. Further, that the above named materials are properly classified, described, packaged, marked and labeled, and are in proper condition for transportation according to the applicable regulations of the Department of Transportation.

Susan Crowley
Generator/Authorized Agent Name Signature Date Shipped

TRANSPORTER INFORMATION

Transporter Name: Las Vegas Paving

DOT # 191949

Address: 4420 S. Decatur

Truck Number: K0019A

Las Vegas, NV 89103

Phone Number: (702) 353-4355

I certify no hazardous waste or other regulated substance was knowingly introduced to the waste while in my custody. The waste transported in this vehicle is the waste identified above, to the best of my knowledge.

ALBERTO
Name of Authorized Agent Signature Date Delivered Oct 4, 2010

DISPOSAL SITE INFORMATION

Site Name: Apex Regional Landfill

Phone No. (702) 599-5920

Address: 13550 U.S. Hwy 93 Las Vegas, NV

I hereby acknowledge receipt of the above described materials
Name (Print or Type) Signature Date Received 05 Oct 10

81 Environmental Tech
13550 N Highway 93
Las Vegas, NV 89165

Ticket Type: INBOUND INVOICE

Ticket Number: 1731
Date: 10/05/2010
Time In: 3:26 am
Time Out: 3:53 am

Customer: 001011 - NGE, LLC c/o Northgate Environ Mgmt

Vehicle/Container: 44166A
Contract: Northgate Env. On Site Soils 3825 11
Comment: 3825 10 11244

Gross Weight: 135,620 LB Manual In
Tare Weight: 56,900 LB Manual Out
Net Weight: 78720 LB
Net Tons: 39.36

BOL: 11829

Origin	Yards	Material	Billing Quantity
Not Applicable	0.00 YD	SW CONTAMINATED SOIL	39.36 TN

Driver: _____

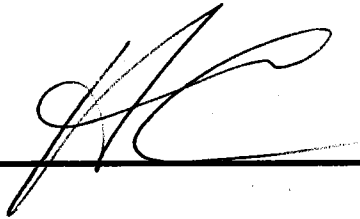

Weighmaster: _____

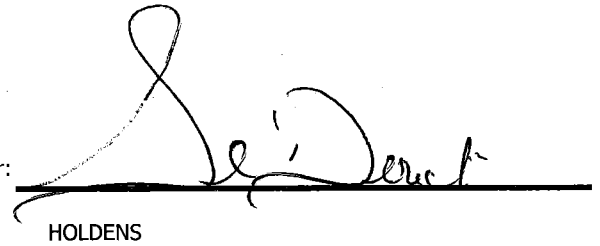

HOLDENS

Indemnification. Customer agrees, by signature above, to indemnify, hold harmless, and defend Republic Services, Inc., its subsidiaries, affiliates, employees, officers and directors from and against any and all liabilities, claims, penalties, forfeitures, suits and the costs and expenses incident thereto, including costs of defense, settlement, and reasonable attorney's fees, which may be incurred, as a result of death or injuries to any person, or damage to any property, contamination of or adverse effects on the environment, caused in whole or in part by the Customer, its employees, or subcontractors in disposing waste at this Facility. In the event Customer delivers Unacceptable Waste (as determined by Republic) Customer agrees to assume all expenses and obligations with the removal and/or resolution of any effects caused by the delivery of such Unacceptable Waste.

Indemnización. Cliente acuerda indemnizar, mantener inmune, y defender Republic Services, Inc., sus subsidiarios, compañías, divisiones, empleados, oficiales y directores contra de cualquiera y de todas responsabilidades, demandas, penas, pérdidas, juicios, pleitos y los costos incidente además, incluyendo costos de defensa, de acuerdo judicial, y de honorarios razonables del abogado, que pueden ser incurridos en, o como resultado de, la muerte o herida personal a cualquier persona, o daños a cualquier característica, propiedad, contaminación de la tierra o efectos ilícitos en esta Facilidad, causado entero o en parte por el cliente, sus empleados, o sus subcontratistas en botar basura en esta Facilidad. En el caso que el Cliente entrega, bota, basura (según lo determinado por Republic) en este Establecimiento basura inaceptable en los reglamentos de este Establecimiento, el Cliente se compromete asumir todos los costos y obligaciones con el retiro y/o la resolución de cualquier dano(s) causado por la entrega de tal basura inaceptable.



NON-HAZARDOUS WASTE MANIFEST

MANIFEST # 11829

GENERATOR INFORMATION

Generator Name: Tronox LLC

Address: P.O. Box 55

City: Henderson County: Clark

State: NV Zip: 89009

Site Location (if different): 560 W. Lake Mead

Henderson, NV 89015 (702) 592-7727

CUSTOMER/BILLING INFORMATION

Billing Name: NGE LLC c/o Northgate Environment Management

Address: 300 Frank Ogawa Plaza, Ste 510

City: Oakland County: Alameda

State: CA Zip: 94612

Republic Services Approval #	Description of Waste	Volume/Weight	Expiration Date	Container Type
38251011244	Soil for disposal	39 ³⁰ / ₁₀₀ ton	12-31-2011	Tractor with Dump Trailer(s)
	RZ- _____ # _____			

*Attach Additional Sheet if necessary

I hereby certify that the above-described materials are non-hazardous wastes as defined by 40 CFR 261 or any applicable state law. Further, that the above named materials are properly classified, described, packaged, marked and labeled, and are in proper condition for transportation according to the applicable regulations of the Department of Transportation.

Susan Crowley

Susan Crowley

Generator/Authorized Agent Name

Signature

Date Shipped

TRANSPORTER INFORMATION

Transporter Name: Las Vegas Paving

DOT # 191949

Address: 4420 S. Decatur

Truck Number: K002

Las Vegas, NV 89103

Phone Number: (702) 353-4355

I certify no hazardous waste or other regulated substance was knowingly introduced to the waste while in my custody. The waste transported in this vehicle is the waste identified above, to the best of my knowledge.

Hugo Castell

[Signature]

10-4-10

Name of Authorized Agent

Signature

Date Delivered

DISPOSAL SITE INFORMATION

Site Name: Apex Regional Landfill

Phone No. (702) 599-5920

Address: 13550 U.S. Hwy 93 Las Vegas, NV

I hereby acknowledge receipt of the above described materials

Holden, Sr. Jenck

[Signature]

05 Oct 10

Name (Print or Type)

Signature

Date Received

81 Environmental Tech
13550 N Highway 93
Las Vegas, NV 89165

Ticket Type: INBOUND INVOICE

Ticket Number: 1732
Date: 10/05/2010
Time In: 3:28 am
Time Out: 3:55 am

Customer: 001011 - NGE, LLC c/o Northgate Environ Mgmt

Vehicle/Container: 34330A
Contract: Northgate Env. On Site Soils 3825 11
Comment: 3825 10 11244

Gross Weight: 124,720 LB Manual In
Tare Weight: 52,620 LB Manual Out
Net Weight: 72100 LB
Net Tons: 36.05

BOL: 11830

Origin	Yards	Material	Billing	Quantity
Not Applicable	0.00 YD	SW CONTAMINATED SOIL	36.05	TN

Driver:

Weighmaster:

HOLDENS

Indemnification. Customer agrees, by signature above, to indemnify, hold harmless, and defend Republic Services, Inc., its subsidiaries, affiliates, employees, officers and directors from and against any and all liabilities, claims, penalties, forfeitures, suits and the costs and expenses incident thereto, including costs of defense, settlement, and reasonable attorney's fees, which may be incurred, as a result of death or injuries to any person, or damage to any property, contamination of or adverse effects on the environment, caused in whole or in part by the Customer, its employees, or subcontractors in disposing waste at this Facility. In the event Customer delivers Unacceptable Waste (as determined by Republic) Customer agrees to assume all expenses and obligations with the removal and/or resolution of any effects caused by the delivery of such Unacceptable Waste.

Indemnización. Cliente acuerda indemnizar, mantener inmune, y defender Republic Services, Inc., sus subsidiarios, compañías, divisiones, empleados, oficiales y directores contra de cualquiera y de todas responsabilidades, demandas, penas, pérdidas, juicios, pleitos y los costos incidente además, incluyendo costos de defensa, de acuerdo judicial, y de honorarios razonables del abogado, que pueden ser incurridos en, o como resultado de, la muerte o herida personal a cualquier persona, o daños a cualquier característica, propiedad, contaminación de la tierra o efectos ilícitos en esta Facilidad, causado entero o en parte por el cliente, sus empleados, o sus subcontratistas en botar basura en esta Facilidad. En el caso que el Cliente entrega, bota, basura (según lo determinado por Republic) en este Establecimiento basura inaceptable en los reglamentos de este Establecimiento, el Cliente se compromete asumir todos los costos y obligaciones con el retiro y/o la resolución de cualquier dano(s) causado por la entrega de tal basura inaceptable.



NON-HAZARDOUS WASTE MANIFEST

MANIFEST # 11830

GENERATOR INFORMATION

Generator Name: Tronox LLC

Address: P.O. Box 55

City: Henderson County: Clark

State: NV Zip: 89009

Site Location (if different): 560 W. Lake Mead
Henderson, NV 89015 (702) 592-7727

CUSTOMER/BILLING INFORMATION

Billing Name: NGE LLC c/o Northgate Environment Management

Address: 300 Frank Ogawa Plaza, Ste 510

City: Oakland County: Alameda

State: CA Zip: 94612

Table with 5 columns: Republic Services Approval #, Description of Waste, Volume/Weight, Expiration Date, Container Type. Row 1: 38251011244, Soil for disposal, 36 tons, 12-31-2011, Tractor with Dump Trailer(s).

*Attach Additional Sheet if necessary

I hereby certify that the above-described materials are non-hazardous wastes as defined by 40 CFR 261 or any applicable state law. Further, that the above named materials are properly classified, described, packaged, marked and labeled, and are in proper condition for transportation according to the applicable regulations of the Department of Transportation.

Susan Crowley (Signature)
Generator/Authorized Agent Name Signature Date Shipped

TRANSPORTER INFORMATION

Transporter Name: Las Vegas Paving

DOT # 191949

Address: 4420 S. Decatur

Truck Number: 981

Las Vegas, NV 89103

Phone Number: (702) 353-4355

I certify no hazardous waste or other regulated substance was knowingly introduced to the waste while in my custody. The waste transported in this vehicle is the waste identified above, to the best of my knowledge.

TOM KAWLING JR (Signature) Thomas Crowley JR (Signature) 10-5-10
Name of Authorized Agent Signature Date Delivered

DISPOSAL SITE INFORMATION

Site Name: Apex Regional Landfill

Phone No. (702) 599-5920

Address: 13550 U.S. Hwy 93 Las Vegas, NV

I hereby acknowledge receipt of the above described materials

Holden Se' Derrick (Signature) De' Derrick Holden (Signature) 05 Oct 10
Name (Print or Type) Signature Date Received

81 Environmental Tech
13550 N Highway 93
Las Vegas, NV 89165

Ticket Type: INBOUND INVOICE

Ticket Number: 1733
Date: 10/05/2010
Time In: 3:42 am
Time Out: 4:12 am

Customer: 001011 - NGE, LLC c/o Northgate Environ Mgmt

Vehicle/Container: 192457
Contract: Northgate Env. On Site Soils 3825 11
Comment: 3825 10 11244

Gross Weight: 128,680 LB Manual In
Tare Weight: 52,080 LB Manual Out
Net Weight: 76600 LB
Net Tons: 38.30

BOL: 11831

Origin	Yards	Material	Billing Quantity
Not Applicable	0.00 YD	SW CONTAMINATED SOIL	38.30 TN

Driver: 

Weighmaster: 

HOLDENS

Indemnification. Customer agrees, by signature above, to indemnify, hold harmless, and defend Republic Services, Inc., its subsidiaries, affiliates, employees, officers and directors from and against any and all liabilities, claims, penalties, forfeitures, suits and the costs and expenses incident thereto, including costs of defense, settlement, and reasonable attorney's fees, which may be incurred, as a result of death or injuries to any person, or damage to any property, contamination of or adverse effects on the environment, caused in whole or in part by the Customer, its employees, or subcontractors in disposing waste at this Facility. In the event Customer delivers Unacceptable Waste (as determined by Republic) Customer agrees to assume all expenses and obligations with the removal and/or resolution of any effects caused by the delivery of such Unacceptable Waste.

Indemnización. Cliente acuerda indemnizar, mantener inmune, y defender Republic Services, Inc., sus subsidiarios, compañías, divisiones, empleados, oficiales y directores contra de cualquiera y de todas responsabilidades, demandas, penas, pérdidas, juicios, pleitos y los costos incidente además, incluyendo costos de defensa, de acuerdo judicial, y de honorarios razonables del abogado, que pueden ser incurridos en, o como resultado de, la muerte o herida personal a cualquier persona, o daños a cualquier característica, propiedad, contaminación de la tierra o efectos ilícitos en esta Facilidad, causado entero o en parte por el cliente, sus empleados, o sus subcontratistas en botar basura en esta Facilidad. En el caso que el Cliente entrega, bota, basura (según lo determinado por Republic) en este Establecimiento basura inaceptable en los reglamentos de este Establecimiento, el Cliente se compromete asumir todos los costos y obligaciones con el retiro y/o la resolución de cualquier dano(s) causado por la entrega de tal basura inaceptable.



NON-HAZARDOUS WASTE MANIFEST

MANIFEST # 11831

GENERATOR INFORMATION

Generator Name: Tronox LLC
Address: P.O. Box 55
City: Henderson County: Clark
State: NV Zip: 89009
Site Location (if different): 560 W. Lake Mead
Henderson, NV 89015 (702) 592-7727

CUSTOMER/BILLING INFORMATION

Billing Name: NGE LLC c/o Northgate Environment Management
Address: 300 Frank Ogawa Plaza, Ste 510
City: Oakland County: Alameda
State: CA Zip: 94612

Table with 5 columns: Republic Services Approval #, Description of Waste, Volume/Weight, Expiration Date, Container Type. Row 1: 38251011244, Soil for disposal, 38 30/100, 12-31-2011, Tractor with Dump Trailer(s).

*Attach Additional Sheet if necessary

I hereby certify that the above-described materials are non-hazardous wastes as defined by 40 CFR 261 or any applicable state law. Further, that the above named materials are properly classified, described, packaged, marked and labeled, and are in proper condition for transportation according to the applicable regulations of the Department of Transportation.

Susan Crowley
Generator/Authorized Agent Name Signature Date Shipped

TRANSPORTER INFORMATION

Transporter Name: Las Vegas Paving DOT # 191949
Address: 4420 S. Decatur Truck Number: 192457
Las Vegas, NV 89103 Phone Number: (702) 353-4355

I certify no hazardous waste or other regulated substance was knowingly introduced to the waste while in my custody. The waste transported in this vehicle is the waste identified above, to the best of my knowledge.

Brian Brinkerhoff
Name of Authorized Agent Signature Date Delivered 10-4-10

DISPOSAL SITE INFORMATION

Site Name: Apex Regional Landfill Phone No. (702) 599-5920
Address: 13550 U.S. Hwy 93 Las Vegas, NV

I hereby acknowledge receipt of the above described materials
Name (Print or Type) Signature Date Received 05 Oct 10

81 Environmental Tech
13550 N Highway 93
Las Vegas, NV 89165

Ticket Type: INBOUND INVOICE

Ticket Number: 1734
Date: 10/05/2010
Time In: 3:54 am
Time Out: 4:24 am

Customer: 001011 - NGE, LLC c/o Northgate Environ Mgmt

Vehicle/Container: 44164A
Contract: Northgate Env. On Site Soils 3825 11
Comment: 3825 10 11244

Gross Weight: 124,060 LB Manual In
Tare Weight: 55,620 LB Manual Out
Net Weight: 68440 LB
Net Tons: 34.22

BOL: 11832

Origin	Yards	Material	Billing Quantity
Not Applicable	0.00 YD	SW CONTAMINATED SOIL	34.22 TN

Driver:

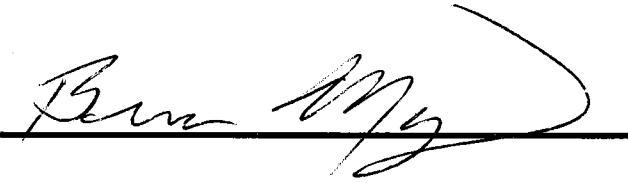

Weighmaster:

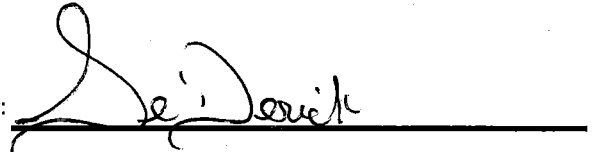

HOLDENS

Indemnification. Customer agrees, by signature above, to indemnify, hold harmless, and defend Republic Services, Inc., its subsidiaries, affiliates, employees, officers and directors from and against any and all liabilities, claims, penalties, forfeitures, suits and the costs and expenses incident thereto, including costs of defense, settlement, and reasonable attorney's fees, which may be incurred, as a result of death or injuries to any person, or damage to any property, contamination of or adverse effects on the environment, caused in whole or in part by the Customer, its employees, or subcontractors in disposing waste at this Facility. In the event Customer delivers Unacceptable Waste (as determined by Republic) Customer agrees to assume all expenses and obligations with the removal and/or resolution of any effects caused by the delivery of such Unacceptable Waste.

Indemnización. Cliente acuerda indemnizar, mantener inmune, y defender Republic Services, Inc., sus subsidiarios, compañías, divisiones, empleados, oficiales y directores contra de cualquiera y de todas responsabilidades, demandas, penas, pérdidas, juicios, pleitos y los costos incidente además, incluyendo costos de defensa, de acuerdo judicial, y de honorarios razonables del abogado, que pueden ser incurridos en, o como resultado de, la muerte o herida personal a cualquier persona, o daños a cualquier característica, propiedad, contaminación de la tierra o efectos ilícitos en esta Facilidad, causado entero o en parte por el cliente, sus empleados, o sus subcontratistas en botar basura en esta Facilidad. En el caso que el Cliente entrega, bota, basura (según lo determinado por Republic) en este Establecimiento basura inaceptable en los reglamentos de este Establecimiento, el Cliente se compromete asumir todos los costos y obligaciones con el retiro y/o la resolución de cualquier dano(s) causado por la entrega de tal basura inaceptable.



NON-HAZARDOUS WASTE MANIFEST

MANIFEST # 11832

GENERATOR INFORMATION

Generator Name: Tronox LLC

Address: P.O. Box 55

City: Henderson County: Clark

State: NV Zip: 89009

Site Location (if different): 560 W. Lake Mead

Henderson, NV 89015 (702) 592-7727

CUSTOMER/BILLING INFORMATION

Billing Name: NGE LLC c/o Northgate Environment Management

Address: 300 Frank Ogawa Plaza, Ste 510

City: Oakland County: Alameda

State: CA Zip: 94612

Republic Services Approval #	Description of Waste	Volume/Weight	Expiration Date	Container Type
38251011244	Soil for disposal	34 ²³ / _{ton}	12-31-2011	Tractor with Dump Trailer(s)
	RZ- #			

*Attach Additional Sheet if necessary

I hereby certify that the above-described materials are non-hazardous wastes as defined by 40 CFR 261 or any applicable state law. Further, that the above named materials are properly classified, described, packaged, marked and labeled, and are in proper condition for transportation according to the applicable regulations of the Department of Transportation.

Susan Crowley *Susan Crowley*
 Generator/Authorized Agent Name Signature Date Shipped

TRANSPORTER INFORMATION

Transporter Name: Las Vegas Paving

DOT # 191949

Address: 4420 S. Decatur

Truck Number: K-006

Las Vegas, NV 89103

Phone Number: (702) 353-4355

I certify no hazardous waste or other regulated substance was knowingly introduced to the waste while in my custody. The waste transported in this vehicle is the waste identified above, to the best of my knowledge.

Brian Maloney *Brian Maloney* 10-8-10
 Name of Authorized Agent Signature Date Delivered

DISPOSAL SITE INFORMATION

Site Name: Apex Regional Landfill

Phone No. (702) 599-5920

Address: 13550 U.S. Hwy 93 Las Vegas, NV

I hereby acknowledge receipt of the above described materials

Holden, Se... *Se...* 05 Oct 10
 Name (Print or Type) Signature Date Received

81 Environmental Tech
13550 N Highway 93
Las Vegas, NV 89165

Ticket Type: INBOUND INVOICE

Ticket Number: 1735
Date: 10/05/2010
Time In: 3:49 am
Time Out: 4:28 am

Customer: 001011 - NGE, LLC c/o Northgate Environ Mgmt

Vehicle/Container: 192456
Contract: Northgate Env. On Site Soils 3825 11
Comment: 3825 10 11244

Gross Weight: 127,300 LB Manual In
Tare Weight: 52,540 LB Manual Out
Net Weight: 74760 LB
Net Tons: 37.38

BOL: 11833

Origin	Yards	Material	Billing Quantity
Not Applicable	0.00 YD	SW CONTAMINATED SOIL	37.38 TN

Driver: _____



Weighmaster: _____

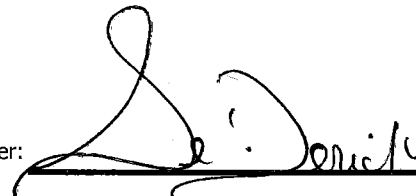

HOLDENS

Indemnification. Customer agrees, by signature above, to indemnify, hold harmless, and defend Republic Services, Inc., its subsidiaries, affiliates, employees, officers and directors from and against any and all liabilities, claims, penalties, forfeitures, suits and the costs and expenses incident thereto, including costs of defense, settlement, and reasonable attorney's fees, which may be incurred, as a result of death or injuries to any person, or damage to any property, contamination of or adverse effects on the environment, caused in whole or in part by the Customer, its employees, or subcontractors in disposing waste at this Facility. In the event Customer delivers Unacceptable Waste (as determined by Republic) Customer agrees to assume all expenses and obligations with the removal and/or resolution of any effects caused by the delivery of such Unacceptable Waste.

Indemnización. Cliente acuerda indemnizar, mantener inmune, y defender Republic Services, Inc., sus subsidiarios, compañías, divisiones, empleados, oficiales y directores contra de cualquiera y de todas responsabilidades, demandas, penas, pérdidas, juicios, pleitos y los costos incidente además, incluyendo costos de defensa, de acuerdo judicial, y de honorarios razonables del abogado, que pueden ser incurridos en, o como resultado de, la muerte o herida personal a cualquier persona, o daños a cualquier característica, propiedad, contaminación de la tierra o efectos ilícitos en esta Facilidad, causado entero o en parte por el cliente, sus empleados, o sus subcontratistas en botar basura en esta Facilidad. En el caso que el Cliente entrega, bota, basura (según lo determinado por Republic) en este Establecimiento basura inaceptable en los reglamentos de este Establecimiento, el Cliente se compromete asumir todos los costos y obligaciones con el retiro y/o la resolución de cualquier dano(s) causado por la entrega de tal basura inaceptable.



NON-HAZARDOUS WASTE MANIFEST

MANIFEST # 11833

GENERATOR INFORMATION

Generator Name: Tronox LLC

Address: P.O. Box 55

City: Henderson County: Clark

State: NV Zip: 89009

Site Location (if different): 560 W. Lake Mead
Henderson, NV 89015 (702) 592-7727

CUSTOMER/BILLING INFORMATION

Billing Name: NGE LLC c/o Northgate Environment Management

Address: 300 Frank Ogawa Plaza, Ste 510

City: Oakland County: Alameda

State: CA Zip: 94612

Table with 5 columns: Republic Services Approval #, Description of Waste, Volume/Weight, Expiration Date, Container Type. Row 1: 38251011244, Soil for disposal, 37 38/100, 12-31-2011, Tractor with Dump Trailer(s).

*Attach Additional Sheet if necessary

I hereby certify that the above-described materials are non-hazardous wastes as defined by 40 CFR 261 or any applicable state law. Further, that the above named materials are properly classified, described, packaged, marked and labeled, and are in proper condition for transportation according to the applicable regulations of the Department of Transportation.

Susan Crowley (Signature)
Generator/Authorized Agent Name Signature Date Shipped

TRANSPORTER INFORMATION

Transporter Name: Las Vegas Paving

DOT # 191949

Address: 4420 S. Decatur

Truck Number: 192486

Las Vegas, NV 89103

Phone Number: (702) 353-4355

I certify no hazardous waste or other regulated substance was knowingly introduced to the waste while in my custody. The waste transported in this vehicle is the waste identified above, to the best of my knowledge.

(Signature)
Name of Authorized Agent Signature Date Delivered 10/4/10

DISPOSAL SITE INFORMATION

Site Name: Apex Regional Landfill

Phone No. (702) 599-5920

Address: 13550 U.S. Hwy 93 Las Vegas, NV

I hereby acknowledge receipt of the above described materials

Holden, Sa Derick (Signature)
Name (Print or Type) Signature Date Received 05 Oct 10

81 Environmental Tech
13550 N Highway 93
Las Vegas, NV 89165

Ticket Type: INBOUND INVOICE

Ticket Number: 1736
Date: 10/05/2010
Time In: 3:55 am
Time Out: 4:29 am

Customer: 001011 - NGE, LLC c/o Northgate Environ Mgmt

Vehicle/Container: 192460
Contract: Northgate Env. On Site Soils 3825 11
Comment: 3825 10 11244

Gross Weight: 127,580 LB Manual In
Tare Weight: 52,980 LB Manual Out
Net Weight: 74600 LB
Net Tons: 37.30

BOL: 11834

Origin	Yards	Material	Billing Quantity
Not Applicable	0.00 YD	SW CONTAMINATED SOIL	37.30 TN

Driver:

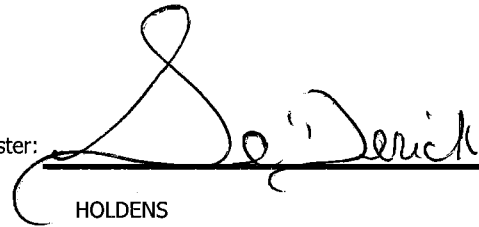

Weighmaster:

HOLDENS

Indemnification. Customer agrees, by signature above, to indemnify, hold harmless, and defend Republic Services, Inc., its subsidiaries, affiliates, employees, officers and directors from and against any and all liabilities, claims, penalties, forfeitures, suits and the costs and expenses incident thereto, including costs of defense, settlement, and reasonable attorney's fees, which may be incurred, as a result of death or injuries to any person, or damage to any property, contamination of or adverse effects on the environment, caused in whole or in part by the Customer, its employees, or subcontractors in disposing waste at this Facility. In the event Customer delivers Unacceptable Waste (as determined by Republic) Customer agrees to assume all expenses and obligations with the removal and/or resolution of any effects caused by the delivery of such Unacceptable Waste.

Indemnización. Cliente acuerda indemnizar, mantener inmune, y defender Republic Services, Inc., sus subsidiarios, compañías, divisiones, empleados, oficiales y directores contra de cualquiera y de todas responsabilidades, demandas, penas, pérdidas, juicios, pleitos y los costos incidente además, incluyendo costos de defensa, de acuerdo judicial, y de honorarios razonables del abogado, que pueden ser incurridos en, o como resultado de, la muerte o herida personal a cualquier persona, o daños a cualquier característica, propiedad, contaminación de la tierra o efectos ilícitos en esta Facilidad, causado entero o en parte por el cliente, sus empleados, o sus subcontratistas en botar basura en esta Facilidad. En el caso que el Cliente entrega, bota, basura (según lo determinado por Republic) en este Establecimiento basura inaceptable en los reglamentos de este Establecimiento, el Cliente se compromete asumir todos los costos y obligaciones con el retiro y/o la resolución de cualquier dano(s) causado por la entrega de tal basura inaceptable.



NON-HAZARDOUS WASTE MANIFEST

MANIFEST # 11834

GENERATOR INFORMATION

Generator Name: Tronox LLC
Address: P.O. Box 55
City: Henderson County: Clark
State: NV Zip: 89009
Site Location (if different): 560 W. Lake Mead
Henderson, NV 89015 (702) 592-7727

CUSTOMER/BILLING INFORMATION

Billing Name: NGE LLC c/o Northgate Environment Management
Address: 300 Frank Ogawa Plaza, Ste 510
City: Oakland County: Alameda
State: CA Zip: 94612

Table with 5 columns: Republic Services Approval #, Description of Waste, Volume/Weight, Expiration Date, Container Type. Row 1: 38251011244, Soil for disposal, 37 30/101, 12-31-2011, Tractor with Dump Trailer(s).

*Attach Additional Sheet if necessary

I hereby certify that the above-described materials are non-hazardous wastes as defined by 40 CFR 261 or any applicable state law. Further, that the above named materials are properly classified, described, packaged, marked and labeled, and are in proper condition for transportation according to the applicable regulations of the Department of Transportation.

Susan Crowley
Generator/Authorized Agent Name Signature Date Shipped

TRANSPORTER INFORMATION

Transporter Name: Las Vegas Paving DOT # 191949
Address: 4420 S. Decatur Truck Number: 2460
Las Vegas, NV 89103 Phone Number: (702) 353-4355

I certify no hazardous waste or other regulated substance was knowingly introduced to the waste while in my custody. The waste transported in this vehicle is the waste identified above, to the best of my knowledge.

Greig Honish
Name of Authorized Agent Signature Date Delivered 10-4-10

DISPOSAL SITE INFORMATION

Site Name: Apex Regional Landfill Phone No. (702) 599-5920
Address: 13550 U.S. Hwy 93 Las Vegas, NV

I hereby acknowledge receipt of the above described materials
Name (Print or Type) Signature Date Received 05 Oct 10

81 Environmental Tech
13550 N Highway 93
Las Vegas, NV 89165

Ticket Type: INBOUND INVOICE

Ticket Number: 1737
Date: 10/05/2010
Time In: 4:13 am
Time Out: 4:38 am

Customer: 001011 - NGE, LLC c/o Northgate Environ Mgmt

Vehicle/Container: 81495P
Contract: Northgate Env. On Site Soils 3825 11
Comment: 3825 10 11244

Gross Weight: 122,760 LB Manual In
Tare Weight: 51,040 LB Manual Out
Net Weight: 71,720 LB
Net Tons: 35.86

BOL: 11836

Origin	Yards	Material	Billing Quantity
Not Applicable	0.00 YD	SW CONTAMINATED SOIL	35.86 TN

Driver:



Weighmaster:

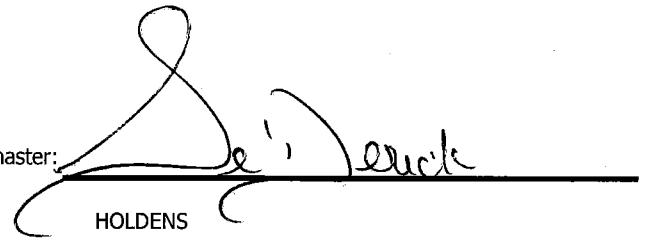

HOLDENS

Indemnification. Customer agrees, by signature above, to indemnify, hold harmless, and defend Republic Services, Inc., its subsidiaries, affiliates, employees, officers and directors from and against any and all liabilities, claims, penalties, forfeitures, suits and the costs and expenses incident thereto, including costs of defense, settlement, and reasonable attorney's fees, which may be incurred, as a result of death or injuries to any person, or damage to any property, contamination of or adverse effects on the environment, caused in whole or in part by the Customer, its employees, or subcontractors in disposing waste at this Facility. In the event Customer delivers Unacceptable Waste (as determined by Republic) Customer agrees to assume all expenses and obligations with the removal and/or resolution of any effects caused by the delivery of such Unacceptable Waste.

Indemnización. Cliente acuerda indemnizar, mantener inmune, y defender Republic Services, Inc., sus subsidiarios, compañías, divisiones, empleados, oficiales y directores contra de cualquiera y de todas responsabilidades, demandas, penas, pérdidas, juicios, pleitos y los costos incidente además, incluyendo costos de defensa, de acuerdo judicial, y de honorarios razonables del abogado, que pueden ser incurridos en, o como resultado de, la muerte o herida personal a cualquier persona, o daños a cualquier característica, propiedad, contaminación de la tierra o efectos ilícitos en esta Facilidad, causado entero o en parte por el cliente, sus empleados, o sus subcontratistas en botar basura en esta Facilidad. En el caso que el Cliente entrega, bota, basura (según lo determinado por Republic) en este Establecimiento basura inaceptable en los reglamentos de este Establecimiento, el Cliente se compromete asumir todos los costos y obligaciones con el retiro y/o la resolución de cualquier dano(s) causado por la entrega de tal basura inaceptable.



NON-HAZARDOUS WASTE MANIFEST

MANIFEST # 11836

GENERATOR INFORMATION

Generator Name: Tronox LLC
Address: P.O. Box 55
City: Henderson County: Clark
State: NV Zip: 89009
Site Location (if different): 560 W. Lake Mead
Henderson, NV 89015 (702) 592-7727

CUSTOMER/BILLING INFORMATION

Billing Name: NGE LLC c/o Northgate Environment Management
Address: 300 Frank Ogawa Plaza, Ste 510
City: Oakland County: Alameda
State: CA Zip: 94612

Table with 5 columns: Republic Services Approval #, Description of Waste, Volume/Weight, Expiration Date, Container Type. Row 1: 38251011244, Soil for disposal, 35 ton, 12-31-2011, Tractor with Dump Trailer(s). Row 2: RZ- #

*Attach Additional Sheet if necessary

I hereby certify that the above-described materials are non-hazardous wastes as defined by 40 CFR 261 or any applicable state law. Further, that the above named materials are properly classified, described, packaged, marked and labeled, and are in proper condition for transportation according to the applicable regulations of the Department of Transportation.

Susan Crowley (Signature)
Generator/Authorized Agent Name Signature Date Shipped

TRANSPORTER INFORMATION

Transporter Name: Las Vegas Paving DOT # 191949
Address: 4420 S. Decatur Truck Number: 175
Las Vegas, NV 89103 Phone Number: (702) 353-4355

I certify no hazardous waste or other regulated substance was knowingly introduced to the waste while in my custody. The waste transported in this vehicle is the waste identified above, to the best of my knowledge.

Larry Harnsberger (Signature)
Name of Authorized Agent Signature Date Delivered 10-1-10

DISPOSAL SITE INFORMATION

Site Name: Apex Regional Landfill Phone No. (702) 599-5920
Address: 13550 U.S. Hwy 93 Las Vegas, NV

I hereby acknowledge receipt of the above described materials
Name (Print or Type) Signature Date Received 05 Oct 10

81 Environmental Tech
13550 N Highway 93
Las Vegas, NV 89165

Ticket Type: INBOUND INVOICE

Ticket Number: 1738
Date: 10/05/2010
Time In: 4:16 am
Time Out: 4:39 am

Customer: 001011 - NGE, LLC c/o Northgate Environ Mgmt

Vehicle/Container: 81496P
Contract: Northgate Env. On Site Soils 3825 11
Comment: 3825 10 11244

Gross Weight: 120,380 LB Manual In
Tare Weight: 50,220 LB Manual Out
Net Weight: 70160 LB
Net Tons: 35.08

BOL: 11837

Origin	Yards	Material	Billing	Quantity
Not Applicable	0.00 YD	SW CONTAMINATED SOIL	35.08	TN

Driver:

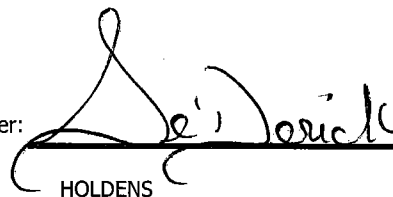

Weighmaster:

HOLDENS

Indemnification. Customer agrees, by signature above, to indemnify, hold harmless, and defend Republic Services, Inc., its subsidiaries, affiliates, employees, officers and directors from and against any and all liabilities, claims, penalties, forfeitures, suits and the costs and expenses incident thereto, including costs of defense, settlement, and reasonable attorney's fees, which may be incurred, as a result of death or injuries to any person, or damage to any property, contamination of or adverse effects on the environment, caused in whole or in part by the Customer, its employees, or subcontractors in disposing waste at this Facility. In the event Customer delivers Unacceptable Waste (as determined by Republic) Customer agrees to assume all expenses and obligations with the removal and/or resolution of any effects caused by the delivery of such Unacceptable Waste.

Indemnización. Cliente acuerda indemnizar, mantener inmune, y defender Republic Services, Inc., sus subsidiarios, compañías, divisiones, empleados, oficiales y directores contra de cualquiera y de todas responsabilidades, demandas, penas, pérdidas, juicios, pleitos y los costos incidente además, incluyendo costos de defensa, de acuerdo judicial, y de honorarios razonables del abogado, que pueden ser incurridos en, o como resultado de, la muerte o herida personal a cualquier persona, o daños a cualquier característica, propiedad, contaminación de la tierra o efectos ilícitos en esta Facilidad, causado entero o en parte por el cliente, sus empleados, o sus subcontratistas en botar basura en esta Facilidad. En el caso que el Cliente entrega, bota, basura (según lo determinado por Republic) en este Establecimiento basura inaceptable en los reglamentos de este Establecimiento, el Cliente se compromete asumir todos los costos y obligaciones con el retiro y/o la resolución de cualquier dano(s) causado por la entrega de tal basura inaceptable.



NON-HAZARDOUS WASTE MANIFEST

MANIFEST # 11837

GENERATOR INFORMATION

Generator Name: Tronox LLC

Address: P.O. Box 55

City: Henderson County: Clark

State: NV Zip: 89009

Site Location (if different): 560 W. Lake Mead
Henderson, NV 89015 (702) 592-7727

CUSTOMER/BILLING INFORMATION

Billing Name: NGE LLC c/o Northgate Environment Management

Address: 300 Frank Ogawa Plaza, Ste 510

City: Oakland County: Alameda

State: CA Zip: 94612

Table with 5 columns: Republic Services Approval #, Description of Waste, Volume/Weight, Expiration Date, Container Type. Row 1: 38251011244, Soil for disposal, 35 00/101, 12-31-2011, Tractor with Dump Trailer(s).

*Attach Additional Sheet if necessary

I hereby certify that the above-described materials are non-hazardous wastes as defined by 40 CFR 261 or any applicable state law. Further, that the above named materials are properly classified, described, packaged, marked and labeled, and are in proper condition for transportation according to the applicable regulations of the Department of Transportation.

Susan Crowley (Signature) Generator/Authorized Agent Name Signature Date Shipped

TRANSPORTER INFORMATION

Transporter Name: Las Vegas Paving

DOT # 191949

Address: 4420 S. Decatur

Truck Number: 145

Las Vegas, NV 89103

Phone Number: (702) 353-4355

I certify no hazardous waste or other regulated substance was knowingly introduced to the waste while in my custody. The waste transported in this vehicle is the waste identified above, to the best of my knowledge.

Harry M. Biel (Signature) Name of Authorized Agent Signature Date Delivered 10-4-10

DISPOSAL SITE INFORMATION

Site Name: Apex Regional Landfill

Phone No. (702) 599-5920

Address: 13550 U.S. Hwy 93 Las Vegas, NV

I hereby acknowledge receipt of the above described materials

Holden, Se' Derek (Signature) Name (Print or Type) Signature Date Received 05 Oct 10

81 Environmental Tech
13550 N Highway 93
Las Vegas, NV 89165

Ticket Type: INBOUND INVOICE

Ticket Number: 1739
Date: 10/05/2010
Time In: 4:08 am
Time Out: 4:48 am

Customer: 001011 - NGE, LLC c/o Northgate Environ Mgmt

Vehicle/Container: 81494P
Contract: Northgate Env. On Site Soils 3825 10
Comment: 3825 10 11244

Gross Weight: 124,980 LB Manual In
Tare Weight: 51,020 LB Manual Out
Net Weight: 73960 LB
Net Tons: 36.98

BOL: 11835

Origin	Yards	Material	Billing Quantity
Not Applicable	0.00 YD	SW CONTAMINATED SOIL	36.98 TN

Driver: _____

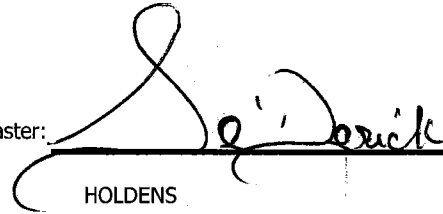

Weighmaster: _____

HOLDENS

Indemnification. Customer agrees, by signature above, to indemnify, hold harmless, and defend Republic Services, Inc., its subsidiaries, affiliates, employees, officers and directors from and against any and all liabilities, claims, penalties, forfeitures, suits and the costs and expenses incident thereto, including costs of defense, settlement, and reasonable attorney's fees, which may be incurred, as a result of death or injuries to any person, or damage to any property, contamination of or adverse effects on the environment, caused in whole or in part by the Customer, its employees, or subcontractors in disposing waste at this Facility. In the event Customer delivers Unacceptable Waste (as determined by Republic) Customer agrees to assume all expenses and obligations with the removal and/or resolution of any effects caused by the delivery of such Unacceptable Waste.

Indemnización. Cliente acuerda indemnizar, mantener inmune, y defender Republic Services, Inc., sus subsidiarios, compañías, divisiones, empleados, oficiales y directores contra de cualquiera y de todas responsabilidades, demandas, penas, pérdidas, juicios, pleitos y los costos incidente además, incluyendo costos de defensa, de acuerdo judicial, y de honorarios razonables del abogado, que pueden ser incurridos en, o como resultado de, la muerte o herida personal a cualquier persona, o daños a cualquier característica, propiedad, contaminación de la tierra o efectos ilícitos en esta Facilidad, causado entero o en parte por el cliente, sus empleados, o sus subcontratistas en botar basura en esta Facilidad. En el caso que el Cliente entrega, bota, basura (según lo determinado por Republic) en este Establecimiento basura inaceptable en los reglamentos de este Establecimiento, el Cliente se compromete asumir todos los costos y obligaciones con el retiro y/o la resolución de cualquier dano(s) causado por la entrega de tal basura inaceptable.



NON-HAZARDOUS WASTE MANIFEST

MANIFEST # 11835

GENERATOR INFORMATION

Generator Name: Tronox LLC

Address: P.O. Box 55

City: Henderson County: Clark

State: NV Zip: 89009

Site Location (if different): 560 W. Lake Mead
Henderson, NV 89015 (702) 592-7727

CUSTOMER/BILLING INFORMATION

Billing Name: NGE LLC c/o Northgate Environment Management

Address: 300 Frank Ogawa Plaza, Ste 510

City: Oakland County: Alameda

State: CA Zip: 94612

Table with 5 columns: Republic Services Approval #, Description of Waste, Volume/Weight, Expiration Date, Container Type. Row 1: 38251011244, Soil for disposal, 36 99/100, 12-31-2011, Tractor with Dump Trailer(s).

*Attach Additional Sheet if necessary

I hereby certify that the above-described materials are non-hazardous wastes as defined by 40 CFR 261 or any applicable state law. Further, that the above named materials are properly classified, described, packaged, marked and labeled, and are in proper condition for transportation according to the applicable regulations of the Department of Transportation.

Susan Crowley
Generator/Authorized Agent Name Signature Date Shipped

TRANSPORTER INFORMATION

Transporter Name: Las Vegas Paving

DOT # 191949

Address: 4420 S. Decatur

Truck Number: 125

Las Vegas, NV 89103

Phone Number: (702) 353-4355

I certify no hazardous waste or other regulated substance was knowingly introduced to the waste while in my custody. The waste transported in this vehicle is the waste identified above, to the best of my knowledge.

Calvin Paguyo
Name of Authorized Agent Signature Date Delivered 10-04-10

DISPOSAL SITE INFORMATION

Site Name: Apex Regional Landfill

Phone No. (702) 599-5920

Address: 13550 U.S. Hwy 93 Las Vegas, NV

I hereby acknowledge receipt of the above described materials
Name (Print or Type) Signature Date Received 05 Oct 10

81 Environmental Tech
13550 N Highway 93
Las Vegas, NV 89165

Ticket Type: INBOUND INVOICE

Ticket Number: 1740
Date: 10/05/2010
Time In: 7:11 am
Time Out: 7:35 am

Customer: 001011 - NGE, LLC c/o Northgate Environ Mgmt

Vehicle/Container: 192391
Contract: Northgate Env. On Site Soils 3825 11
Comment: 3825 10 21144

Gross Weight: 89,580 LB Scale In
Tare Weight: 39,160 LB Scale Out
Net Weight: 50420 LB
Net Tons: 25.21

BOL: 11838

Origin	Yards	Material	Billing	Quantity
Not Applicable	0.00 YD	SW CONTAMINATED SOIL	25.21	TN

Driver: _____



Weighmaster: _____

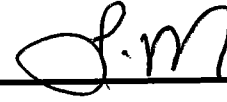

MORENOJ

Indemnification. Customer agrees, by signature above, to indemnify, hold harmless, and defend Republic Services, Inc., its subsidiaries, affiliates, employees, officers and directors from and against any and all liabilities, claims, penalties, forfeitures, suits and the costs and expenses incident thereto, including costs of defense, settlement, and reasonable attorney's fees, which may be incurred, as a result of death or injuries to any person, or damage to any property, contamination of or adverse effects on the environment, caused in whole or in part by the Customer, its employees, or subcontractors in disposing waste at this Facility. In the event Customer delivers Unacceptable Waste (as determined by Republic) Customer agrees to assume all expenses and obligations with the removal and/or resolution of any effects caused by the delivery of such Unacceptable Waste.

Indemnización. Cliente acuerda indemnizar, mantener inmune, y defender Republic Services, Inc., sus subsidiarios, compañías, divisiones, empleados, oficiales y directores contra de cualquiera y de todas responsabilidades, demandas, penas, pérdidas, juicios, pleitos y los costos incidente además, incluyendo costos de defensa, de acuerdo judicial, y de honorarios razonables del abogado, que pueden ser incurridos en, o como resultado de, la muerte o herida personal a cualquier persona, o daños a cualquier característica, propiedad, contaminación de la tierra o efectos ilícitos en esta Facilidad, causado entero o en parte por el cliente, sus empleados, o sus subcontratistas en botar basura en esta Facilidad. En el caso que el Cliente entrega, bota, basura (según lo determinado por Republic) en este Establecimiento basura inaceptable en los reglamentos de este Establecimiento, el Cliente se compromete asumir todos los costos y obligaciones con el retiro y/o la resolución de cualquier dano(s) causado por la entrega de tal basura inaceptable.



NON-HAZARDOUS WASTE MANIFEST

MANIFEST # 11838

GENERATOR INFORMATION

Generator Name: Tronox LLC
Address: P.O. Box 55
City: Henderson County: Clark
State: NV Zip: 89009
Site Location (if different): 560 W. Lake Mead
Henderson, NV 89015 (702) 592-7727

CUSTOMER/BILLING INFORMATION

Billing Name: NGE LLC c/o Northgate Environment Management
Address: 300 Frank Ogawa Plaza, Ste 510
City: Oakland County: Alameda
State: CA Zip: 94612

Table with 5 columns: Republic Services Approval #, Description of Waste, Volume/Weight, Expiration Date, Container Type. Row 1: 38251011244, Soil for disposal, 25.21 TM, 12-31-2011, Tractor with Dump Trailer(s).

*Attach Additional Sheet if necessary

I hereby certify that the above-described materials are non-hazardous wastes as defined by 40 CFR 261 or any applicable state law. Further, that the above named materials are properly classified, described, packaged, marked and labeled, and are in proper condition for transportation according to the applicable regulations of the Department of Transportation.

Susan Crowley (Signature)
Generator/Authorized Agent Name Signature Date Shipped

TRANSPORTER INFORMATION

Transporter Name: Las Vegas Paving DOT # 191949
Address: 4420 S. Decatur Truck Number: 192391
Las Vegas, NV 89103 Phone Number: (702) 353-4355

I certify no hazardous waste or other regulated substance was knowingly introduced to the waste while in my custody. The waste transported in this vehicle is the waste identified above, to the best of my knowledge.

(Signature) 10-05-10
Name of Authorized Agent Signature Date Delivered

DISPOSAL SITE INFORMATION

Site Name: Apex Regional Landfill Phone No. (702) 599-5920
Address: 13550 U.S. Hwy 93 Las Vegas, NV

I hereby acknowledge receipt of the above described materials
Juan Moreno (Signature) 10-5-10
Name (Print or Type) Signature Date Received

81 Environmental Tech
13550 N Highway 93
Las Vegas, NV 89165

Ticket Type: INBOUND INVOICE

Ticket Number: 1741
Date: 10/05/2010
Time In: 7:20 am
Time Out: 7:50 am

Customer: 001011 - NGE, LLC c/o Northgate Environ Mgmt

Vehicle/Container: 192346
Contract: Northgate Env Asbestos Soils 3825 1
Comment: 3825 10 11244

Gross Weight: 96,040 LB Scale In
Tare Weight: 37,060 LB Scale Out
Net Weight: 58980 LB
Net Tons: 29.49

BOL: 11839

Origin	Yards	Material	Billing Quantity
Not Applicable	0.00 YD	ASBESTOS NONFRIABLE <i>cont soil</i>	29.49 TN

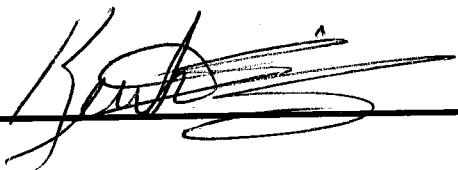
Driver: 

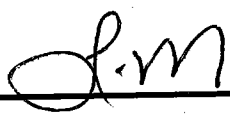
Weighmaster: 
MORENOJ

Indemnification. Customer agrees, by signature above, to indemnify, hold harmless, and defend Republic Services, Inc., its subsidiaries, affiliates, employees, officers and directors from and against any and all liabilities, claims, penalties, forfeitures, suits and the costs and expenses incident thereto, including costs of defense, settlement, and reasonable attorney's fees, which may be incurred, as a result of death or injuries to any person, or damage to any property, contamination of or adverse effects on the environment, caused in whole or in part by the Customer, its employees, or subcontractors in disposing waste at this Facility. In the event Customer delivers Unacceptable Waste (as determined by Republic) Customer agrees to assume all expenses and obligations with the removal and/or resolution of any effects caused by the delivery of such Unacceptable Waste.

Indemnización. Cliente acuerda indemnizar, mantener inmune, y defender Republic Services, Inc., sus subsidiarios, compañías, divisiones, empleados, oficiales y directores contra de cualquiera y de todas responsabilidades, demandas, penas, pérdidas, juicios, pleitos y los costos incidente además, incluyendo costos de defensa, de acuerdo judicial, y de honorarios razonables del abogado, que pueden ser incurridos en, o como resultado de, la muerte o herida personal a cualquier persona, o daños a cualquier característica, propiedad, contaminación de la tierra o efectos ilícitos en esta Facilidad, causado entero o en parte por el cliente, sus empleados, o sus subcontratistas en botar basura en esta Facilidad. En el caso que el Cliente entrega, bota, basura (según lo determinado por Republic) en este Establecimiento basura inaceptable en los reglamentos de este Establecimiento, el Cliente se compromete asumir todos los costos y obligaciones con el retiro y/o la resolución de cualquier dano(s) causado por la entrega de tal basura inaceptable.



NON-HAZARDOUS WASTE MANIFEST

MANIFEST # 11839

GENERATOR INFORMATION

Generator Name: Tronox LLC
Address: P.O. Box 55
City: Henderson County: Clark
State: NV Zip: 89009
Site Location (if different): 560 W. Lake Mead
Henderson, NV 89015 (702) 592-7727

CUSTOMER/BILLING INFORMATION

Billing Name: NGE LLC c/o Northgate Environment Management
Address: 300 Frank Ogawa Plaza, Ste 510
City: Oakland County: Alameda
State: CA Zip: 94612

Table with 5 columns: Republic Services Approval #, Description of Waste, Volume/Weight, Expiration Date, Container Type. Row 1: 38251011244, Soil for disposal, 29.49 TN, 12-31-2011, Tractor with Dump Trailer(s).

*Attach Additional Sheet if necessary

I hereby certify that the above-described materials are non-hazardous wastes as defined by 40 CFR 261 or any applicable state law. Further, that the above named materials are properly classified, described, packaged, marked and labeled, and are in proper condition for transportation according to the applicable regulations of the Department of Transportation.

Susan Crowley (Signature)
Generator/Authorized Agent Name Signature Date Shipped

TRANSPORTER INFORMATION

Transporter Name: Las Vegas Paving DOT # 191949
Address: 4420 S. Decatur Truck Number: 192346
Las Vegas, NV 89103 Phone Number: (702) 353-4355

I certify no hazardous waste or other regulated substance was knowingly introduced to the waste while in my custody. The waste transported in this vehicle is the waste identified above, to the best of my knowledge.

(Signature) 10-05-10
Name of Authorized Agent Signature Date Delivered

DISPOSAL SITE INFORMATION

Site Name: Apex Regional Landfill Phone No. (702) 599-5920
Address: 13550 U.S. Hwy 93 Las Vegas, NV

I hereby acknowledge receipt of the above described materials
Juan Moreno (Signature) 10-5-10
Name (Print or Type) Signature Date Received

81 Environmental Tech
13550 N Highway 93
Las Vegas, NV 89165

Ticket Type: INBOUND INVOICE

Ticket Number: 1742
Date: 10/05/2010
Time In: 7:26 am
Time Out: 7:52 am

Customer: 001011 - NGE, LLC c/o Northgate Environ Mgmt

Vehicle/Container: 192364
Contract: Northgate Env Asbestos Soils 3825 1
Comment: 3825 10 11244

Gross Weight: 94,260 LB Scale In
Tare Weight: 38,480 LB Manual Out
Net Weight: 55780 LB
Net Tons: 27.89

BOL: 11840

Origin	Yards	Material	Billing	Quantity
Not Applicable	0.00 YD	ASBESTOS NONFRIABLE <i>Cont soil</i>	27.89	TN

Driver: 

Weighmaster: 

MORENOJ

Indemnification. Customer agrees, by signature above, to indemnify, hold harmless, and defend Republic Services, Inc., its subsidiaries, affiliates, employees, officers and directors from and against any and all liabilities, claims, penalties, forfeitures, suits and the costs and expenses incident thereto, including costs of defense, settlement, and reasonable attorney's fees, which may be incurred, as a result of death or injuries to any person, or damage to any property, contamination of or adverse effects on the environment, caused in whole or in part by the Customer, its employees, or subcontractors in disposing waste at this Facility. In the event Customer delivers Unacceptable Waste (as determined by Republic) Customer agrees to assume all expenses and obligations with the removal and/or resolution of any effects caused by the delivery of such Unacceptable Waste.

Indemnización. Cliente acuerda indemnizar, mantener inmune, y defender Republic Services, Inc., sus subsidiarios, compañías, divisiones, empleados, oficiales y directores contra de cualquiera y de todas responsabilidades, demandas, penas, pérdidas, juicios, pleitos y los costos incidente además, incluyendo costos de defensa, de acuerdo judicial, y de honorarios razonables del abogado, que pueden ser incurridos en, o como resultado de, la muerte o herida personal a cualquier persona, o daños a cualquier característica, propiedad, contaminación de la tierra o efectos ilícitos en esta Facilidad, causado entero o en parte por el cliente, sus empleados, o sus subcontratistas en botar basura en esta Facilidad. En el caso que el Cliente entrega, bota, basura (según lo determinado por Republic) en este Establecimiento basura inaceptable en los reglamentos de este Establecimiento, el Cliente se compromete asumir todos los costos y obligaciones con el retiro y/o la resolución de cualquier dano(s) causado por la entrega de tal basura inaceptable.



NON-HAZARDOUS WASTE MANIFEST

MANIFEST # 11840

GENERATOR INFORMATION

Generator Name: Tronox LLC

Address: P.O. Box 55

City: Henderson County: Clark

State: NV Zip: 89009

Site Location (if different): 560 W. Lake Mead

Henderson, NV 89015 (702) 592-7727

CUSTOMER/BILLING INFORMATION

Billing Name: NGE LLC c/o Northgate Environment Management

Address: 300 Frank Ogawa Plaza, Ste 510

City: Oakland County: Alameda

State: CA Zip: 94612

Republic Services Approval #	Description of Waste	Volume/Weight	Expiration Date	Container Type
38251011244	Soil for disposal		12-31-2011	Tractor with Dump Trailer(s)
	RZ- #	27.89 TN		

*Attach Additional Sheet if necessary

I hereby certify that the above-described materials are non-hazardous wastes as defined by 40 CFR 261 or any applicable state law. Further, that the above named materials are properly classified, described, packaged, marked and labeled, and are in proper condition for transportation according to the applicable regulations of the Department of Transportation.

Susan Crowley (Signature) Generator/Authorized Agent Name Date Shipped

TRANSPORTER INFORMATION

Transporter Name: Las Vegas Paving

DOT # 191949

Address: 4420 S. Decatur

Truck Number: 192364

Las Vegas, NV 89103

Phone Number: (702) 353-4355

I certify no hazardous waste or other regulated substance was knowingly introduced to the waste while in my custody. The waste transported in this vehicle is the waste identified above, to the best of my knowledge.

(Signature) Name of Authorized Agent Signature Date Delivered 10-05-10

DISPOSAL SITE INFORMATION

Site Name: Apex Regional Landfill

Phone No. (702) 599-5920

Address: 13550 U.S. Hwy 93 Las Vegas, NV

I hereby acknowledge receipt of the above described materials (Signature) Name (Print or Type) Signature Date Received 10-5-10

81 Environmental Tech
13550 N Highway 93
Las Vegas, NV 89165

Ticket Type: INBOUND INVOICE

Ticket Number: 1744
Date: 10/05/2010
Time In: 9:12 am
Time Out: 9:37 am

Customer: 001011 - NGE, LLC c/o Northgate Environ Mgmt

Vehicle/Container: 192391
Contract: Northgate Env. On Site Soils 3825 11
Comment: 3825 10 11244

Gross Weight: 88,160 LB Scale In
Tare Weight: 39,020 LB Scale Out
Net Weight: 49140 LB
Net Tons: 24.57

BOL: 11841

Origin	Yards	Material	Billing	Quantity
Not Applicable	0.00 YD	SW CONTAMINATED SOIL	24.57	TN

Driver: 

Weighmaster: 

IN - MORENOJ OUT - WALKERA

Indemnification. Customer agrees, by signature above, to indemnify, hold harmless, and defend Republic Services, Inc., its subsidiaries, affiliates, employees, officers and directors from and against any and all liabilities, claims, penalties, forfeitures, suits and the costs and expenses incident thereto, including costs of defense, settlement, and reasonable attorney's fees, which may be incurred, as a result of death or injuries to any person, or damage to any property, contamination of or adverse effects on the environment, caused in whole or in part by the Customer, its employees, or subcontractors in disposing waste at this Facility. In the event Customer delivers Unacceptable Waste (as determined by Republic) Customer agrees to assume all expenses and obligations with the removal and/or resolution of any effects caused by the delivery of such Unacceptable Waste.

Indemnización. Cliente acuerda indemnizar, mantener inmune, y defender Republic Services, Inc., sus subsidiarios, compañías, divisiones, empleados, oficiales y directores contra de cualquiera y de todas responsabilidades, demandas, penas, pérdidas, juicios, pleitos y los costos incidente además, incluyendo costos de defensa, de acuerdo judicial, y de honorarios razonables del abogado, que pueden ser incurridos en, o como resultado de, la muerte o herida personal a cualquier persona, o daños a cualquier característica, propiedad, contaminación de la tierra o efectos ilícitos en esta Facilidad, causado entero o en parte por el cliente, sus empleados, o sus subcontratistas en botar basura en esta Facilidad. En el caso que el Cliente entrega, bota, basura (según lo determinado por Republic) en este Establecimiento basura inaceptable en los reglamentos de este Establecimiento, el Cliente se compromete asumir todos los costos y obligaciones con el retiro y/o la resolución de cualquier dano(s) causado por la entrega de tal basura inaceptable.



NON-HAZARDOUS WASTE MANIFEST

MANIFEST # 11841

GENERATOR INFORMATION

Generator Name: Tronox LLC
Address: P.O. Box 55
City: Henderson County: Clark
State: NV Zip: 89009
Site Location (if different): 560 W. Lake Mead
Henderson, NV 89015 (702) 592-7727

CUSTOMER/BILLING INFORMATION

Billing Name: NGE LLC c/o Northgate Environment Management
Address: 300 Frank Ogawa Plaza, Ste 510
City: Oakland County: Alameda
State: CA Zip: 94612

Table with 5 columns: Republic Services Approval #, Description of Waste, Volume/Weight, Expiration Date, Container Type. Row 1: 38251011244, Soil for disposal, 24.57 TN, 12-31-2011, Tractor with Dump Trailer(s).

*Attach Additional Sheet if necessary

I hereby certify that the above-described materials are non-hazardous wastes as defined by 40 CFR 261 or any applicable state law. Further, that the above named materials are properly classified, described, packaged, marked and labeled, and are in proper condition for transportation according to the applicable regulations of the Department of Transportation.

Susan Crowley
Generator/Authorized Agent Name Signature Date Shipped

TRANSPORTER INFORMATION

Transporter Name: Las Vegas Paving DOT # 191949
Address: 4420 S. Decatur Truck Number: 192391
Las Vegas, NV 89103 Phone Number: (702) 353-4355

I certify no hazardous waste or other regulated substance was knowingly introduced to the waste while in my custody. The waste transported in this vehicle is the waste identified above, to the best of my knowledge.

Name of Authorized Agent Signature Date Delivered

DISPOSAL SITE INFORMATION

Site Name: Apex Regional Landfill Phone No. (702) 599-5920
Address: 13550 U.S. Hwy 93 Las Vegas, NV

I hereby acknowledge receipt of the above described materials

Name (Print or Type) Signature Date Received

81 Environmental Tech
13550 N Highway 93
Las Vegas, NV 89165

Ticket Type: INBOUND INVOICE

Ticket Number: 1745
Date: 10/05/2010
Time In: 9:36 am
Time Out: 9:58 am

Customer: 001011 - NGE, LLC c/o Northgate Environ Mgmt

Vehicle/Container: 192346
Contract: Northgate Env. On Site Soils 3825 11
Comment: 3825-10-11244

Gross Weight: 86,960 LB Scale In
Tare Weight: 36,960 LB Scale Out
Net Weight: 50000 LB
Net Tons: 25.00

BOL: 11842

Origin	Yards	Material	Billing	Quantity
Not Applicable	0.00 YD	SW CONTAMINATED SOIL	25.00	TN

Driver: 

Weighmaster: 

WALKERA

Indemnification. Customer agrees, by signature above, to indemnify, hold harmless, and defend Republic Services, Inc., its subsidiaries, affiliates, employees, officers and directors from and against any and all liabilities, claims, penalties, forfeitures, suits and the costs and expenses incident thereto, including costs of defense, settlement, and reasonable attorney's fees, which may be incurred, as a result of death or injuries to any person, or damage to any property, contamination of or adverse effects on the environment, caused in whole or in part by the Customer, its employees, or subcontractors in disposing waste at this Facility. In the event Customer delivers Unacceptable Waste (as determined by Republic) Customer agrees to assume all expenses and obligations with the removal and/or resolution of any effects caused by the delivery of such Unacceptable Waste.

Indemnización. Cliente acuerda indemnizar, mantener inmune, y defender Republic Services, Inc., sus subsidiarios, compañías, divisiones, empleados, oficiales y directores contra de cualquiera y de todas responsabilidades, demandas, penas, pérdidas, juicios, pleitos y los costos incidente además, incluyendo costos de defensa, de acuerdo judicial, y de honorarios razonables del abogado, que pueden ser incurridos en, o como resultado de, la muerte o herida personal a cualquier persona, o daños a cualquier característica, propiedad, contaminación de la tierra o efectos ilícitos en esta Facilidad, causado entero o en parte por el cliente, sus empleados, o sus subcontratistas en botar basura en esta Facilidad. En el caso que el Cliente entrega, bota, basura (según lo determinado por Republic) en este Establecimiento basura inaceptable en los reglamentos de este Establecimiento, el Cliente se compromete asumir todos los costos y obligaciones con el retiro y/o la resolución de cualquier dano(s) causado por la entrega de tal basura inaceptable.



NON-HAZARDOUS WASTE MANIFEST

MANIFEST # 11842

GENERATOR INFORMATION

Generator Name: Tronox LLC

Address: P.O. Box 55

City: Henderson County: Clark

State: NV Zip: 89009

Site Location (if different): 560 W. Lake Mead

Henderson, NV 89015 (702) 592-7727

CUSTOMER/BILLING INFORMATION

Billing Name: NGE LLC c/o Northgate Environment Management

Address: 300 Frank Ogawa Plaza, Ste 510

City: Oakland County: Alameda

State: CA Zip: 94612

Republic Services Approval #	Description of Waste	Volume/Weight	Expiration Date	Container Type
38251011244	Soil for disposal		12-31-2011	Tractor with Dump Trailer(s)
	RZ- #	25.00 TN	25.00	

*Attach Additional Sheet if necessary

I hereby certify that the above-described materials are non-hazardous wastes as defined by 40 CFR 261 or any applicable state law. Further, that the above named materials are properly classified, described, packaged, marked and labeled, and are in proper condition for transportation according to the applicable regulations of the Department of Transportation.

Susan Crowley Generator/Authorized Agent Name Signature Date Shipped

TRANSPORTER INFORMATION

Transporter Name: Las Vegas Paving

DOT # 191949

Address: 4420 S. Decatur

Truck Number: 192346

Las Vegas, NV 89103

Phone Number: (702) 353-4355

I certify no hazardous waste or other regulated substance was knowingly introduced to the waste while in my custody. The waste transported in this vehicle is the waste identified above, to the best of my knowledge.

Name of Authorized Agent Signature Date Delivered 10-05-10

DISPOSAL SITE INFORMATION

Site Name: Apex Regional Landfill

Phone No. (702) 599-5920

Address: 13550 U.S. Hwy 93 Las Vegas, NV

I hereby acknowledge receipt of the above described materials Name (Print or Type) Signature Date Received 10/5/10

81 Environmental Tech
13550 N Highway 93
Las Vegas, NV 89165

Ticket Type: INBOUND INVOICE

Ticket Number: 1746
Date: 10/05/2010
Time In: 9:43 am
Time Out: 10:12 am

Customer: 001011 - NGE, LLC c/o Northgate Environ Mgmt

Vehicle/Container: 192364
Contract: Northgate Env Asbestos Soils 3825 1
Comment: 3825-10-11244

Gross Weight: 88,500 LB Scale In
Tare Weight: 38,300 LB Scale Out
Net Weight: 50200 LB
Net Tons: 25.10

BOL: 11843

Origin	Yards	Material	Billing	Quantity
Not Applicable	0.00 YD	ASBESTOS NONFRIABLE	25.10	TN

Driver: 

Weighmaster: 

WALKERA

Indemnification. Customer agrees, by signature above, to indemnify, hold harmless, and defend Republic Services, Inc., its subsidiaries, affiliates, employees, officers and directors from and against any and all liabilities, claims, penalties, forfeitures, suits and the costs and expenses incident thereto, including costs of defense, settlement, and reasonable attorney's fees, which may be incurred, as a result of death or injuries to any person, or damage to any property, contamination of or adverse effects on the environment, caused in whole or in part by the Customer, its employees, or subcontractors in disposing waste at this Facility. In the event Customer delivers Unacceptable Waste (as determined by Republic) Customer agrees to assume all expenses and obligations with the removal and/or resolution of any effects caused by the delivery of such Unacceptable Waste.

Indemnización. Cliente acuerda indemnizar, mantener inmune, y defender Republic Services, Inc., sus subsidiarios, compañías, divisiones, empleados, oficiales y directores contra de cualquiera y de todas responsabilidades, demandas, penas, pérdidas, juicios, pleitos y los costos incidente además, incluyendo costos de defensa, de acuerdo judicial, y de honorarios razonables del abogado, que pueden ser incurridos en, o como resultado de, la muerte o herida personal a cualquier persona, o daños a cualquier característica, propiedad, contaminación de la tierra o efectos ilícitos en esta Facilidad, causado entero o en parte por el cliente, sus empleados, o sus subcontratistas en botar basura en esta Facilidad. En el caso que el Cliente entrega, bota, basura (según lo determinado por Republic) en este Establecimiento basura inaceptable en los reglamentos de este Establecimiento, el Cliente se compromete asumir todos los costos y obligaciones con el retiro y/o la resolución de cualquier dano(s) causado por la entrega de tal basura inaceptable.



NON-HAZARDOUS WASTE MANIFEST

MANIFEST # 11843

GENERATOR INFORMATION

Generator Name: Tronox LLC
Address: P.O. Box 55
City: Henderson County: Clark
State: NV Zip: 89009
Site Location (if different): 560 W. Lake Mead
Henderson, NV 89015 (702) 592-7727

CUSTOMER/BILLING INFORMATION

Billing Name: NGE LLC c/o Northgate Environment Management
Address: 300 Frank Ogawa Plaza, Ste 510
City: Oakland County: Alameda
State: CA Zip: 94612

Table with 5 columns: Republic Services Approval #, Description of Waste, Volume/Weight, Expiration Date, Container Type. Row 1: 38251011244, Soil for disposal, 12-31-2011, Tractor with Dump Trailer(s). Row 2: RZ- #, 0510.

*Attach Additional Sheet if necessary

I hereby certify that the above-described materials are non-hazardous wastes as defined by 40 CFR 261 or any applicable state law. Further, that the above named materials are properly classified, described, packaged, marked and labeled, and are in proper condition for transportation according to the applicable regulations of the Department of Transportation.

Susan Crowley (Signature)
Generator/Authorized Agent Name Signature Date Shipped

TRANSPORTER INFORMATION

Transporter Name: Las Vegas Paving DOT # 191949
Address: 4420 S. Decatur Truck Number: 192364
Las Vegas, NV 89103 Phone Number: (702) 353-4355

I certify no hazardous waste or other regulated substance was knowingly introduced to the waste while in my custody. The waste transported in this vehicle is the waste identified above, to the best of my knowledge.

(Signature)
Name of Authorized Agent Signature Date Delivered 10-05-10

DISPOSAL SITE INFORMATION

Site Name: Apex Regional Landfill Phone No. (702) 599-5920
Address: 13550 U.S. Hwy 93 Las Vegas, NV

I hereby acknowledge receipt of the above described materials
(Signature)
Name (Print or Type) Signature Date Received 10/5/10

81 Environmental Tech
13550 N Highway 93
Las Vegas, NV 89165

Ticket Type: INBOUND INVOICE

Ticket Number: 1747
Date: 10/05/2010
Time In: 11:35 am
Time Out: 12:00 pm

Customer: 001011 - NGE, LLC c/o Northgate Environ Mgmt

Vehicle/Container: 192391
Contract: Northgate Env. On Site Soils 3825 11
Comment: 3825-10-11244

Gross Weight: 89,140 LB Scale In
Tare Weight: 38,900 LB Scale Out
Net Weight: 50240 LB
Net Tons: 25.12

BOL: 11844

Origin	Yards	Material	Billing	Quantity
Not Applicable	0.00 YD	SW CONTAMINATED SOIL	25.12	TN

Driver: _____

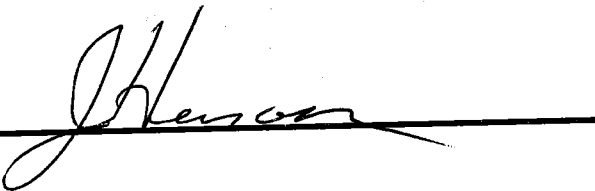

Weighmaster: _____

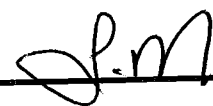

IN - GUILFDE OUT - MORENOJ

Indemnification. Customer agrees, by signature above, to indemnify, hold harmless, and defend Republic Services, Inc., its subsidiaries, affiliates, employees, officers and directors from and against any and all liabilities, claims, penalties, forfeitures, suits and the costs and expenses incident thereto, including costs of defense, settlement, and reasonable attorney's fees, which may be incurred, as a result of death or injuries to any person, or damage to any property, contamination of or adverse effects on the environment, caused in whole or in part by the Customer, its employees, or subcontractors in disposing waste at this Facility. In the event Customer delivers Unacceptable Waste (as determined by Republic) Customer agrees to assume all expenses and obligations with the removal and/or resolution of any effects caused by the delivery of such Unacceptable Waste.

Indemnización. Cliente acuerda indemnizar, mantener inmune, y defender Republic Services, Inc., sus subsidiarios, compañías, divisiones, empleados, oficiales y directores contra de cualquiera y de todas responsabilidades, demandas, penas, pérdidas, juicios, pleitos y los costos incidente además, incluyendo costos de defensa, de acuerdo judicial, y de honorarios razonables del abogado, que pueden ser incurridos en, o como resultado de, la muerte o herida personal a cualquier persona, o daños a cualquier característica, propiedad, contaminación de la tierra o efectos ilícitos en esta Facilidad, causado entero o en parte por el cliente, sus empleados, o sus subcontratistas en botar basura en esta Facilidad. En el caso que el Cliente entrega, bota, basura (según lo determinado por Republic) en este Establecimiento basura inaceptable en los reglamentos de este Establecimiento, el Cliente se compromete asumir todos los costos y obligaciones con el retiro y/o la resolución de cualquier dano(s) causado por la entrega de tal basura inaceptable.



NON-HAZARDOUS WASTE MANIFEST

MANIFEST # 11844

GENERATOR INFORMATION

Generator Name: Tronox LLC

Address: P.O. Box 55

City: Henderson County: Clark

State: NV Zip: 89009

Site Location (if different): 560 W. Lake Mead

Henderson, NV 89015 (702) 592-7727

CUSTOMER/BILLING INFORMATION

Billing Name: NGE LLC c/o Northgate Environment Management

Address: 300 Frank Ogawa Plaza, Ste 510

City: Oakland County: Alameda

State: CA Zip: 94612

Republic Services Approval #	Description of Waste	Volume/Weight	Expiration Date	Container Type
38251011244	Soil for disposal		12-31-2011	Tractor with Dump Trailer(s)
	RZ- #	25.12 TN		

*Attach Additional Sheet if necessary

I hereby certify that the above-described materials are non-hazardous wastes as defined by 40 CFR 261 or any applicable state law. Further, that the above named materials are properly classified, described, packaged, marked and labeled, and are in proper condition for transportation according to the applicable regulations of the Department of Transportation.

Susan Crowley Generator/Authorized Agent Name Signature Date Shipped

TRANSPORTER INFORMATION

Transporter Name: Las Vegas Paving

DOT # 191949

Address: 4420 S. Decatur

Truck Number: 192391

Las Vegas, NV 89103

Phone Number: (702) 353-4355

I certify no hazardous waste or other regulated substance was knowingly introduced to the waste while in my custody. The waste transported in this vehicle is the waste identified above, to the best of my knowledge.

Name of Authorized Agent Signature Date Delivered 10-05-10

DISPOSAL SITE INFORMATION

Site Name: Apex Regional Landfill

Phone No. (702) 599-5920

Address: 13550 U.S. Hwy 93 Las Vegas, NV

I hereby acknowledge receipt of the above described materials Juan Moreno Signature Date Received 10-05-10

81 Environmental Tech
13550 N Highway 93
Las Vegas, NV 89165

Ticket Type: INBOUND INVOICE

Ticket Number: 1748
Date: 10/05/2010
Time In: 11:44 am
Time Out: 12:09 pm

Customer: 001011 - NGE, LLC c/o Northgate Environ Mgmt

Vehicle/Container: 192346

Gross Weight: 88,580 LB Scale In
Tare Weight: 36,580 LB Scale Out
Net Weight: 52000 LB
Net Tons: 26.00

Contract: Northgate Env. On Site Soils 3825 11

Comment: 3825 10 11244

BOL: 11845

Origin	Yards	Material	Billing Quantity
Not Applicable	0.00 YD	SW CONTAMINATED SOIL	26.00 TN

Driver: _____



Weighmaster: _____

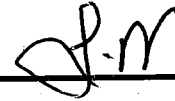

MORENOJ

Indemnification. Customer agrees, by signature above, to indemnify, hold harmless, and defend Republic Services, Inc., its subsidiaries, affiliates, employees, officers and directors from and against any and all liabilities, claims, penalties, forfeitures, suits and the costs and expenses incident thereto, including costs of defense, settlement, and reasonable attorney's fees, which may be incurred, as a result of death or injuries to any person, or damage to any property, contamination of or adverse effects on the environment, caused in whole or in part by the Customer, its employees, or subcontractors in disposing waste at this Facility. In the event Customer delivers Unacceptable Waste (as determined by Republic) Customer agrees to assume all expenses and obligations with the removal and/or resolution of any effects caused by the delivery of such Unacceptable Waste.

Indemnización. Cliente acuerda indemnizar, mantener inmune, y defender Republic Services, Inc., sus subsidiarios, compañías, divisiones, empleados, oficiales y directores contra de cualquiera y de todas responsabilidades, demandas, penas, pérdidas, juicios, pleitos y los costos incidente además, incluyendo costos de defensa, de acuerdo judicial, y de honorarios razonables del abogado, que pueden ser incurridos en, o como resultado de, la muerte o herida personal a cualquier persona, o daños a cualquier característica, propiedad, contaminación de la tierra o efectos ilícitos en esta Facilidad, causado entero o en parte por el cliente, sus empleados, o sus subcontratistas en botar basura en esta Facilidad. En el caso que el Cliente entrega, bota, basura (según lo determinado por Republic) en este Establecimiento basura inaceptable en los reglamentos de este Establecimiento, el Cliente se compromete asumir todos los costos y obligaciones con el retiro y/o la resolución de cualquier dano(s) causado por la entrega de tal basura inaceptable.



NON-HAZARDOUS WASTE MANIFEST

MANIFEST # 11845

GENERATOR INFORMATION

Generator Name: Tronox LLC
Address: P.O. Box 55
City: Henderson County: Clark
State: NV Zip: 89009
Site Location (if different): 560 W. Lake Mead
Henderson, NV 89015 (702) 592-7727

CUSTOMER/BILLING INFORMATION

Billing Name: NGE LLC c/o Northgate Environment Management
Address: 300 Frank Ogawa Plaza, Ste 510
City: Oakland County: Alameda
State: CA Zip: 94612

Table with 5 columns: Republic Services Approval #, Description of Waste, Volume/Weight, Expiration Date, Container Type. Row 1: 38251011244, Soil for disposal, 26.00 TN, 12-31-2011, Tractor with Dump Trailer(s).

*Attach Additional Sheet if necessary

I hereby certify that the above-described materials are non-hazardous wastes as defined by 40 CFR 261 or any applicable state law. Further, that the above named materials are properly classified, described, packaged, marked and labeled, and are in proper condition for transportation according to the applicable regulations of the Department of Transportation.

Susan Crowley (Signature)
Generator/Authorized Agent Name Signature Date Shipped

TRANSPORTER INFORMATION

Transporter Name: Las Vegas Paving DOT # 191949
Address: 4420 S. Decatur Truck Number: 192346
Las Vegas, NV 89103 Phone Number: (702) 353-4355

I certify no hazardous waste or other regulated substance was knowingly introduced to the waste while in my custody. The waste transported in this vehicle is the waste identified above, to the best of my knowledge.

(Signature)
Name of Authorized Agent Signature Date Delivered 10-05-10

DISPOSAL SITE INFORMATION

Site Name: Apex Regional Landfill Phone No. (702) 599-5920
Address: 13550 U.S. Hwy 93 Las Vegas, NV

I hereby acknowledge receipt of the above described materials
Juan Moreno (Signature)
Name (Print or Type) Signature Date Received 10-5-10

81 Environmental Tech
13550 N Highway 93
Las Vegas, NV 89165

Ticket Type: INBOUND INVOICE

Ticket Number: 1749
Date: 10/05/2010
Time In: 11:53 am
Time Out: 12:17 pm

Customer: 001011 - NGE, LLC c/o Northgate Environ Mgmt

Vehicle/Container: 192364
Contract: Northgate Env Asbestos Soils 3825 1
Comment: 3825-10-11244

Gross Weight: 91,780 LB Scale In
Tare Weight: 38,140 LB Scale Out
Net Weight: 53640 LB
Net Tons: 26.82

BOL: 11846

Origin	Yards	Material	Billing	Quantity
Not Applicable	0.00 YD	ASBESTOS NONFRIABLE <i>cont soil</i>	26.82	TN

Driver: _____

Weighmaster: _____

IN - WALKERA OUT - MORENOJ

Indemnification. Customer agrees, by signature above, to indemnify, hold harmless, and defend Republic Services, Inc., its subsidiaries, affiliates, employees, officers and directors from and against any and all liabilities, claims, penalties, forfeitures, suits and the costs and expenses incident thereto, including costs of defense, settlement, and reasonable attorney's fees, which may be incurred, as a result of death or injuries to any person, or damage to any property, contamination of or adverse effects on the environment, caused in whole or in part by the Customer, its employees, or subcontractors in disposing waste at this Facility. In the event Customer delivers Unacceptable Waste (as determined by Republic) Customer agrees to assume all expenses and obligations with the removal and/or resolution of any effects caused by the delivery of such Unacceptable Waste.

Indemnización. Cliente acuerda indemnizar, mantener inmune, y defender Republic Services, Inc., sus subsidiarios, compañías, divisiones, empleados, oficiales y directores contra de cualquiera y de todas responsabilidades, demandas, penas, pérdidas, juicios, pleitos y los costos incidente además, incluyendo costos de defensa, de acuerdo judicial, y de honorarios razonables del abogado, que pueden ser incurridos en, o como resultado de, la muerte o herida personal a cualquier persona, o daños a cualquier característica, propiedad, contaminación de la tierra o efectos ilícitos en esta Facilidad, causado entero o en parte por el cliente, sus empleados, o sus subcontratistas en botar basura en esta Facilidad. En el caso que el Cliente entrega, bota, basura (según lo determinado por Republic) en este Establecimiento basura inaceptable en los reglamentos de este Establecimiento, el Cliente se compromete asumir todos los costos y obligaciones con el retiro y/o la resolución de cualquier dano(s) causado por la entrega de tal basura inaceptable.



NON-HAZARDOUS WASTE MANIFEST

MANIFEST # 11846

GENERATOR INFORMATION

Generator Name: Tronox LLC

Address: P.O. Box 55

City: Henderson County: Clark

State: NV Zip: 89009

Site Location (if different): 560 W. Lake Mead

Henderson, NV 89015 (702) 592-7727

CUSTOMER/BILLING INFORMATION

Billing Name: NGE LLC c/o Northgate Environment Management

Address: 300 Frank Ogawa Plaza, Ste 510

City: Oakland County: Alameda

State: CA Zip: 94612

Republic Services Approval #	Description of Waste	Volume/Weight	Expiration Date	Container Type
38251011244	Soil for disposal		12-31-2011	Tractor with Dump Trailer(s)
	RZ- #	26.82 TN		

*Attach Additional Sheet if necessary

I hereby certify that the above-described materials are non-hazardous wastes as defined by 40 CFR 261 or any applicable state law. Further, that the above named materials are properly classified, described, packaged, marked and labeled, and are in proper condition for transportation according to the applicable regulations of the Department of Transportation.

Susan Crowley Generator/Authorized Agent Name Signature Date Shipped

TRANSPORTER INFORMATION

Transporter Name: Las Vegas Paving

DOT # 191949

Address: 4420 S. Decatur

Truck Number: 192364

Las Vegas, NV 89103

Phone Number: (702) 353-4355

I certify no hazardous waste or other regulated substance was knowingly introduced to the waste while in my custody. The waste transported in this vehicle is the waste identified above, to the best of my knowledge.

Name of Authorized Agent Signature Date Delivered 10-05-10

DISPOSAL SITE INFORMATION

Site Name: Apex Regional Landfill

Phone No. (702) 599-5920

Address: 13550 U.S. Hwy 93 Las Vegas, NV

I hereby acknowledge receipt of the above described materials Juan Moreno Signature Date Received 10-5-10

81 Environmental Tech
13550 N Highway 93
Las Vegas, NV 89165

Ticket Type: INBOUND INVOICE

Ticket Number: 1752
Date: 10/05/2010
Time In: 7:56 pm
Time Out: 8:18 pm

Customer: 001011 - NGE, LLC c/o Northgate Environ Mgmt

Vehicle/Container: 81495P
Contract: Northgate Env. On Site Soils 3825 11
Comment: 3825 10 11244

Gross Weight: 118,080 LB Manual In
Tare Weight: 51,140 LB Manual Out
Net Weight: 66940 LB
Net Tons: 33.47

BOL: 11847

Origin	Yards	Material	Billing Quantity
Not Applicable	0.00 YD	SW CONTAMINATED SOIL	33.47 TN

Driver:



Weighmaster:

CARTERJ

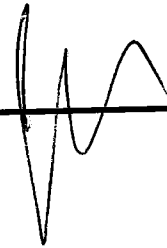

Indemnification. Customer agrees, by signature above, to indemnify, hold harmless, and defend Republic Services, Inc., its subsidiaries, affiliates, employees, officers and directors from and against any and all liabilities, claims, penalties, forfeitures, suits and the costs and expenses incident thereto, including costs of defense, settlement, and reasonable attorney's fees, which may be incurred, as a result of death or injuries to any person, or damage to any property, contamination of or adverse effects on the environment, caused in whole or in part by the Customer, its employees, or subcontractors in disposing waste at this Facility. In the event Customer delivers Unacceptable Waste (as determined by Republic) Customer agrees to assume all expenses and obligations with the removal and/or resolution of any effects caused by the delivery of such Unacceptable Waste.

Indemnización. Cliente acuerda indemnizar, mantener inmune, y defender Republic Services, Inc., sus subsidiarios, compañías, divisiones, empleados, oficiales y directores contra de cualquiera y de todas responsabilidades, demandas, penas, pérdidas, juicios, pleitos y los costos incidente además, incluyendo costos de defensa, de acuerdo judicial, y de honorarios razonables del abogado, que pueden ser incurridos en, o como resultado de, la muerte o herida personal a cualquier persona, o daños a cualquier característica, propiedad, contaminación de la tierra o efectos ilícitos en esta Facilidad, causado entero o en parte por el cliente, sus empleados, o sus subcontratistas en botar basura en esta Facilidad. En el caso que el Cliente entrega, bota, basura (según lo determinado por Republic) en este Establecimiento basura inaceptable en los reglamentos de este Establecimiento, el Cliente se compromete asumir todos los costos y obligaciones con el retiro y/o la resolución de cualquier dano(s) causado por la entrega de tal basura inaceptable.



SR 40177

NON-HAZARDOUS WASTE MANIFEST MANIFEST # 11847

GENERATOR INFORMATION

Generator Name: Tronox LLC
Address: P.O. Box 55
City: Henderson County: Clark
State: NV Zip: 89009
Site Location (if different): 560 W. Lake Mead
Henderson, NV 89015 (702) 592-7727

CUSTOMER/BILLING INFORMATION

Billing Name: NGE LLC c/o Northgate Environment Management
Address: 300 Frank Ogawa Plaza, Ste 510
City: Oakland County: Alameda
State: CA Zip: 94612

Table with 5 columns: Republic Services Approval #, Description of Waste, Volume/Weight, Expiration Date, Container Type. Row 1: 38251011244, Soil for disposal, 33.47 TN, 12-31-2011, Tractor with Dump Trailer(s). Row 2: RZ- #

*Attach Additional Sheet if necessary

I hereby certify that the above-described materials are non-hazardous wastes as defined by 40 CFR 261 or any applicable state law. Further, that the above named materials are properly classified, described, packaged, marked and labeled, and are in proper condition for transportation according to the applicable regulations of the Department of Transportation.

Susan Crowley
Generator/Authorized Agent Name Signature Date Shipped

TRANSPORTER INFORMATION

Transporter Name: Las Vegas Paving DOT # 191949
Address: 4420 S. Decatur Truck Number: 175
Las Vegas, NV 89103 Phone Number: (702) 353-4355

I certify no hazardous waste or other regulated substance was knowingly introduced to the waste while in my custody. The waste transported in this vehicle is the waste identified above, to the best of my knowledge.

Larry Harnsberger
Name of Authorized Agent Signature Date Delivered 10-5-10

DISPOSAL SITE INFORMATION

Site Name: Apex Regional Landfill Phone No. (702) 599-5920
Address: 13550 U.S. Hwy 93 Las Vegas, NV

I hereby acknowledge receipt of the above described materials
Name (Print or Type) Signature Date Received 10/5/10

81 Environmental Tech
13550 N Highway 93
Las Vegas, NV 89165

Ticket Type: INBOUND INVOICE

Ticket Number: 1753
Date: 10/05/2010
Time In: 7:58 pm
Time Out: 8:19 pm

Customer: 001011 - NGE, LLC c/o Northgate Environ Mgmt

Vehicle/Container: 81496P
Contract: Northgate Env. On Site Soils 3825 11
Comment: 3825 10 11244

Gross Weight: 118,880 LB Manual In
Tare Weight: 50,360 LB Manual Out
Net Weight: 68520 LB
Net Tons: 34.26

BOL: 11848

Origin	Yards	Material	Billing Quantity
Not Applicable	0.00 YD	SW CONTAMINATED SOIL	34.26 TN

Driver: 

Weighmaster: 

IN - CARTERJ OUT - HOLDENS

Indemnification. Customer agrees, by signature above, to indemnify, hold harmless, and defend Republic Services, Inc., its subsidiaries, affiliates, employees, officers and directors from and against any and all liabilities, claims, penalties, forfeitures, suits and the costs and expenses incident thereto, including costs of defense, settlement, and reasonable attorney's fees, which may be incurred, as a result of death or injuries to any person, or damage to any property, contamination of or adverse effects on the environment, caused in whole or in part by the Customer, its employees, or subcontractors in disposing waste at this Facility. In the event Customer delivers Unacceptable Waste (as determined by Republic) Customer agrees to assume all expenses and obligations with the removal and/or resolution of any effects caused by the delivery of such Unacceptable Waste.

Indemnización. Cliente acuerda indemnizar, mantener inmune, y defender Republic Services, Inc., sus subsidiarios, compañías, divisiones, empleados, oficiales y directores contra de cualquiera y de todas responsabilidades, demandas, penas, pérdidas, juicios, pleitos y los costos incidente además, incluyendo costos de defensa, de acuerdo judicial, y de honorarios razonables del abogado, que pueden ser incurridos en, o como resultado de, la muerte o herida personal a cualquier persona, o daños a cualquier característica, propiedad, contaminación de la tierra o efectos ilícitos en esta Facilidad, causado entero o en parte por el cliente, sus empleados, o sus subcontratistas en botar basura en esta Facilidad. En el caso que el Cliente entrega, bota, basura (según lo determinado por Republic) en este Establecimiento basura inaceptable en los reglamentos de este Establecimiento, el Cliente se compromete asumir todos los costos y obligaciones con el retiro y/o la resolución de cualquier dano(s) causado por la entrega de tal basura inaceptable.



NON-HAZARDOUS WASTE MANIFEST MANIFEST # 11848

GENERATOR INFORMATION

Generator Name: Tronox LLC
Address: P.O. Box 55
City: Henderson County: Clark
State: NV Zip: 89009
Site Location (if different): 560 W. Lake Mead
Henderson, NV 89015 (702) 592-7727

CUSTOMER/BILLING INFORMATION

Billing Name: NGE LLC c/o Northgate Environment Management
Address: 300 Frank Ogawa Plaza, Ste 510
City: Oakland County: Alameda
State: CA Zip: 94612

Table with 5 columns: Republic Services Approval #, Description of Waste, Volume/Weight, Expiration Date, Container Type. Row 1: 38251011244, Soil for disposal, 34 26/100, 12-31-2011, Tractor with Dump Trailer(s).

*Attach Additional Sheet if necessary

I hereby certify that the above-described materials are non-hazardous wastes as defined by 40 CFR 261 or any applicable state law. Further, that the above named materials are properly classified, described, packaged, marked and labeled, and are in proper condition for transportation according to the applicable regulations of the Department of Transportation.

Susan Crowley (Signature)
Generator/Authorized Agent Name Signature Date Shipped

TRANSPORTER INFORMATION

Transporter Name: Las Vegas Paving DOT # 191949
Address: 4420 S. Decatur Truck Number: 145
Las Vegas, NV 89103 Phone Number: (702) 353-4355

I certify no hazardous waste or other regulated substance was knowingly introduced to the waste while in my custody. The waste transported in this vehicle is the waste identified above, to the best of my knowledge.

Harry W. Gier (Signature)
Name of Authorized Agent Signature Date Delivered 10-5-10

DISPOSAL SITE INFORMATION

Site Name: Apex Regional Landfill Phone No. (702) 599-5920
Address: 13550 U.S. Hwy 93 Las Vegas, NV

I hereby acknowledge receipt of the above described materials
Name (Print or Type) Signature Date Received 05 Oct 10

81 Environmental Tech
13550 N Highway 93
Las Vegas, NV 89165

Ticket Type: INBOUND INVOICE

Ticket Number: 1754
Date: 10/05/2010
Time In: 7:57 pm
Time Out: 8:21 pm

Customer: 001011 - NGE, LLC c/o Northgate Environ Mgmt

Vehicle/Container: 35903A
Contract: Northgate Env. On Site Soils 3825 11
Comment: 3825 10 11244

Gross Weight: 124,020 LB Manual In
Tare Weight: 55,520 LB Manual Out
Net Weight: 68500 LB
Net Tons: 34.25

BOL: 11850

Origin	Yards	Material	Billing	Quantity
Not Applicable	0.00 YD	SW CONTAMINATED SOIL	34.25	TN

Driver: _____

Weighmaster: _____

HOLDENS

Indemnification. Customer agrees, by signature above, to indemnify, hold harmless, and defend Republic Services, Inc., its subsidiaries, affiliates, employees, officers and directors from and against any and all liabilities, claims, penalties, forfeitures, suits and the costs and expenses incident thereto, including costs of defense, settlement, and reasonable attorney's fees, which may be incurred, as a result of death or injuries to any person, or damage to any property, contamination of or adverse effects on the environment, caused in whole or in part by the Customer, its employees, or subcontractors in disposing waste at this Facility. In the event Customer delivers Unacceptable Waste (as determined by Republic) Customer agrees to assume all expenses and obligations with the removal and/or resolution of any effects caused by the delivery of such Unacceptable Waste.

Indemnización. Cliente acuerda indemnizar, mantener inmune, y defender Republic Services, Inc., sus subsidiarios, compañías, divisiones, empleados, oficiales y directores contra de cualquiera y de todas responsabilidades, demandas, penas, pérdidas, juicios, pleitos y los costos incidente además, incluyendo costos de defensa, de acuerdo judicial, y de honorarios razonables del abogado, que pueden ser incurridos en, o como resultado de, la muerte o herida personal a cualquier persona, o daños a cualquier característica, propiedad, contaminación de la tierra o efectos ilícitos en esta Facilidad, causado entero o en parte por el cliente, sus empleados, o sus subcontratistas en botar basura en esta Facilidad. En el caso que el Cliente entrega, bota, basura (según lo determinado por Republic) en este Establecimiento basura inaceptable en los reglamentos de este Establecimiento, el Cliente se compromete asumir todos los costos y obligaciones con el retiro y/o la resolución de cualquier dano(s) causado por la entrega de tal basura inaceptable.



NON-HAZARDOUS WASTE MANIFEST

MANIFEST # 11850

GENERATOR INFORMATION

Generator Name: Tronox LLC

Address: P.O. Box 55

City: Henderson County: Clark

State: NV Zip: 89009

Site Location (if different): 560 W. Lake Mead

Henderson, NV 89015 (702) 592-7727

CUSTOMER/BILLING INFORMATION

Billing Name: NGE LLC c/o Northgate Environment Management

Address: 300 Frank Ogawa Plaza, Ste 510

City: Oakland County: Alameda

State: CA Zip: 94612

Republic Services Approval #	Description of Waste	Volume/Weight	Expiration Date	Container Type
38251011244	Soil for disposal	34 ²⁵ / _{ton}	12-31-2011	Tractor with Dump Trailer(s)
	RZ- _____ # _____			

*Attach Additional Sheet if necessary

I hereby certify that the above-described materials are non-hazardous wastes as defined by 40 CFR 261 or any applicable state law. Further, that the above named materials are properly classified, described, packaged, marked and labeled, and are in proper condition for transportation according to the applicable regulations of the Department of Transportation.

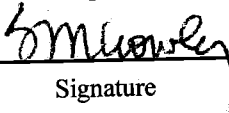
Susan Crowley  _____
 Generator/Authorized Agent Name Signature Date Shipped

TRANSPORTER INFORMATION

Transporter Name: Las Vegas Paving

DOT # 191949

Address: 4420 S. Decatur

Truck Number: 07

Las Vegas, NV 89103

Phone Number: (702) 353-4355

I certify no hazardous waste or other regulated substance was knowingly introduced to the waste while in my custody. The waste transported in this vehicle is the waste identified above, to the best of my knowledge.

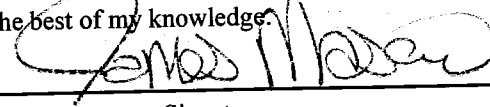
Wardos BC  _____
 Name of Authorized Agent Signature Date Delivered 10-5-10

DISPOSAL SITE INFORMATION

Site Name: Apex Regional Landfill

Phone No. (702) 599-5920

Address: 13550 U.S. Hwy 93 Las Vegas, NV

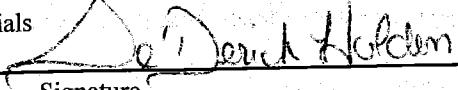
I hereby acknowledge receipt of the above described materials
Holden, Se Derick  _____
 Name (Print or Type) Signature Date Received 05 Oct 10

81 Environmental Tech
13550 N Highway 93
Las Vegas, NV 89165

Ticket Type: INBOUND INVOICE

Ticket Number: 1755
Date: 10/05/2010
Time In: 7:59 pm
Time Out: 8:23 pm

Customer: 001011 - NGE, LLC c/o Northgate Environ Mgmt

Vehicle/Container: 81494P
Contract: Northgate Env. On Site Soils 3825 11
Comment: 3825 10 11244

Gross Weight: 118,780 LB Manual In
Tare Weight: 51,060 LB Manual Out
Net Weight: 67,720 LB
Net Tons: 33.86

BOL: 11849

Origin	Yards	Material	Billing	Quantity
Not Applicable	0.00 YD	SW CONTAMINATED SOIL	33.86	TN

Driver: _____

Weighmaster: _____

CARTERJ

Indemnification. Customer agrees, by signature above, to indemnify, hold harmless, and defend Republic Services, Inc., its subsidiaries, affiliates, employees, officers and directors from and against any and all liabilities, claims, penalties, forfeitures, suits and the costs and expenses incident thereto, including costs of defense, settlement, and reasonable attorney's fees, which may be incurred, as a result of death or injuries to any person, or damage to any property, contamination of or adverse effects on the environment, caused in whole or in part by the Customer, its employees, or subcontractors in disposing waste at this Facility. In the event Customer delivers Unacceptable Waste (as determined by Republic) Customer agrees to assume all expenses and obligations with the removal and/or resolution of any effects caused by the delivery of such Unacceptable Waste.

Indemnización. Cliente acuerda indemnizar, mantener inmune, y defender Republic Services, Inc., sus subsidiarios, compañías, divisiones, empleados, oficiales y directores contra de cualquiera y de todas responsabilidades, demandas, penas, pérdidas, juicios, pleitos y los costos incidente además, incluyendo costos de defensa, de acuerdo judicial, y de honorarios razonables del abogado, que pueden ser incurridos en, o como resultado de, la muerte o herida personal a cualquier persona, o daños a cualquier característica, propiedad, contaminación de la tierra o efectos ilícitos en esta Facilidad, causado entero o en parte por el cliente, sus empleados, o sus subcontratistas en botar basura en esta Facilidad. En el caso que el Cliente entrega, bota, basura (según lo determinado por Republic) en este Establecimiento basura inaceptable en los reglamentos de este Establecimiento, el Cliente se compromete asumir todos los costos y obligaciones con el retiro y/o la resolución de cualquier dano(s) causado por la entrega de tal basura inaceptable.



NON-HAZARDOUS WASTE MANIFEST

MANIFEST # 11849

GENERATOR INFORMATION

Generator Name: Tronox LLC

Address: P.O. Box 55

City: Henderson County: Clark

State: NV Zip: 89009

Site Location (if different): 560 W. Lake Mead

Henderson, NV 89015 (702) 592-7727

CUSTOMER/BILLING INFORMATION

Billing Name: NGE LLC c/o Northgate Environment Management

Address: 300 Frank Ogawa Plaza, Ste 510

City: Oakland County: Alameda

State: CA Zip: 94612

Republic Services Approval #	Description of Waste	Volume/Weight	Expiration Date	Container Type
38251011244	Soil for disposal	33.86 TN	12-31-2011	Tractor with Dump Trailer(s)
	RZ- _____ # _____			

*Attach Additional Sheet if necessary

I hereby certify that the above-described materials are non-hazardous wastes as defined by 40 CFR 261 or any applicable state law. Further, that the above named materials are properly classified, described, packaged, marked and labeled, and are in proper condition for transportation according to the applicable regulations of the Department of Transportation.

Susan Crowley (Signature) Date Shipped

TRANSPORTER INFORMATION

Transporter Name: Las Vegas Paving

DOT # 191949

Address: 4420 S. Decatur

Truck Number: 125

Las Vegas, NV 89103

Phone Number: (702) 353-4355

I certify no hazardous waste or other regulated substance was knowingly introduced to the waste while in my custody. The waste transported in this vehicle is the waste identified above, to the best of my knowledge.

Calvin Paguyo (Signature) Date Delivered: 10-05-10

DISPOSAL SITE INFORMATION

Site Name: Apex Regional Landfill

Phone No. (702) 599-5920

Address: 13550 U.S. Hwy 93 Las Vegas, NV

I hereby acknowledge receipt of the above described materials

JASON CARTER (Signature) Date Received: 10/5/10

81 Environmental Tech
13550 N Highway 93
Las Vegas, NV 89165

Ticket Type: INBOUND INVOICE

Ticket Number: 1756
Date: 10/05/2010
Time In: 8:01 pm
Time Out: 8:22 pm

Customer: 001011 - NGE, LLC c/o Northgate Environ Mgmt

Vehicle/Container: 82418P
Contract: Northgate Env. On Site Soils 3825 11
Comment: 3825 10 11244

Gross Weight: 135,700 LB Manual In
Tare Weight: 62,140 LB Manual Out
Net Weight: 73560 LB
Net Tons: 36.78

BOL: 11851

Origin	Yards	Material	Billing Quantity
Not Applicable	0.00 YD	SW CONTAMINATED SOIL	36.78 TN

Driver:

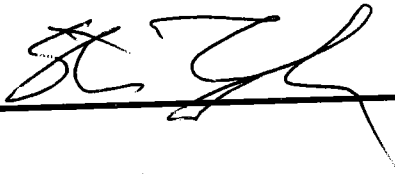

Weighmaster:

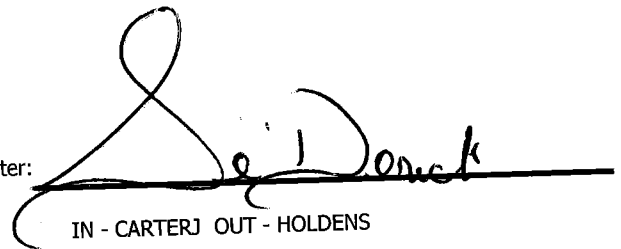

IN - CARTERJ OUT - HOLDENS

Indemnification. Customer agrees, by signature above, to indemnify, hold harmless, and defend Republic Services, Inc., its subsidiaries, affiliates, employees, officers and directors from and against any and all liabilities, claims, penalties, forfeitures, suits and the costs and expenses incident thereto, including costs of defense, settlement, and reasonable attorney's fees, which may be incurred, as a result of death or injuries to any person, or damage to any property, contamination of or adverse effects on the environment, caused in whole or in part by the Customer, its employees, or subcontractors in disposing waste at this Facility. In the event Customer delivers Unacceptable Waste (as determined by Republic) Customer agrees to assume all expenses and obligations with the removal and/or resolution of any effects caused by the delivery of such Unacceptable Waste.

Indemnización. Cliente acuerda indemnizar, mantener inmune, y defender Republic Services, Inc., sus subsidiarios, compañías, divisiones, empleados, oficiales y directores contra de cualquiera y de todas responsabilidades, demandas, penas, pérdidas, juicios, pleitos y los costos incidente además, incluyendo costos de defensa, de acuerdo judicial, y de honorarios razonables del abogado, que pueden ser incurridos en, o como resultado de, la muerte o herida personal a cualquier persona, o daños a cualquier característica, propiedad, contaminación de la tierra o efectos ilícitos en esta Facilidad, causado entero o en parte por el cliente, sus empleados, o sus subcontratistas en botar basura en esta Facilidad. En el caso que el Cliente entrega, bota, basura (según lo determinado por Republic) en este Establecimiento basura inaceptable en los reglamentos de este Establecimiento, el Cliente se compromete asumir todos los costos y obligaciones con el retiro y/o la resolución de cualquier dano(s) causado por la entrega de tal basura inaceptable.



NON-HAZARDOUS WASTE MANIFEST

MANIFEST # 11851

GENERATOR INFORMATION

Generator Name: Tronox LLC

Address: P.O. Box 55

City: Henderson County: Clark

State: NV Zip: 89009

Site Location (if different): 560 W. Lake Mead

Henderson, NV 89015 (702) 592-7727

CUSTOMER/BILLING INFORMATION

Billing Name: NGE LLC c/o Northgate Environment Management

Address: 300 Frank Ogawa Plaza, Ste 510

City: Oakland County: Alameda

State: CA Zip: 94612

Republic Services Approval #	Description of Waste	Volume/Weight	Expiration Date	Container Type
38251011244	Soil for disposal	36 ⁷⁹ / ₁₀₀	12-31-2011	Tractor with Dump Trailer(s)
	RZ- _____ # _____			

*Attach Additional Sheet if necessary

I hereby certify that the above-described materials are non-hazardous wastes as defined by 40 CFR 261 or any applicable state law. Further, that the above named materials are properly classified, described, packaged, marked and labeled, and are in proper condition for transportation according to the applicable regulations of the Department of Transportation.

Susan Crowley
Generator/Authorized Agent Name

[Signature]
Signature

Date Shipped

TRANSPORTER INFORMATION

Transporter Name: Las Vegas Paving

DOT # 191949

Address: 4420 S. Decatur

Truck Number: 220

Las Vegas, NV 89103

Phone Number: (702) 353-4355

I certify no hazardous waste or other regulated substance was knowingly introduced to the waste while in my custody. The waste transported in this vehicle is the waste identified above, to the best of my knowledge.

STEVE TAYLOR
Name of Authorized Agent

[Signature]
Signature

10-5-10
Date Delivered

DISPOSAL SITE INFORMATION

Site Name: Apex Regional Landfill

Phone No. (702) 599-5920

Address: 13550 U.S. Hwy 93 Las Vegas, NV

I hereby acknowledge receipt of the above described materials

Halden, Se' Drick
Name (Print or Type)

[Signature]
Signature

05 Oct 10
Date Received

81 Environmental Tech
13550 N Highway 93
Las Vegas, NV 89165

Ticket Type: INBOUND INVOICE

Ticket Number: 1757
Date: 10/05/2010
Time In: 8:09 pm
Time Out: 8:34 pm

Customer: 001011 - NGE, LLC c/o Northgate Environ Mgmt

Vehicle/Container: 34330A
Contract: Northgate Env. On Site Soils 3825 11
Comment: 3825 10 11244

Gross Weight: 121,260 LB Manual In
Tare Weight: 52,420 LB Manual Out
Net Weight: 68840 LB
Net Tons: 34.42

BOL: 11852

Origin	Yards	Material	Billing	Quantity
Not Applicable	0.00 YD	SW CONTAMINATED SOIL	34.42	TN

Driver:

Thomas Rawls Jr

Weighmaster:

CARTERJ

Indemnification. Customer agrees, by signature above, to indemnify, hold harmless, and defend Republic Services, Inc., its subsidiaries, affiliates, employees, officers and directors from and against any and all liabilities, claims, penalties, forfeitures, suits and the costs and expenses incident thereto, including costs of defense, settlement, and reasonable attorney's fees, which may be incurred, as a result of death or injuries to any person, or damage to any property, contamination of or adverse effects on the environment, caused in whole or in part by the Customer, its employees, or subcontractors in disposing waste at this Facility. In the event Customer delivers Unacceptable Waste (as determined by Republic) Customer agrees to assume all expenses and obligations with the removal and/or resolution of any effects caused by the delivery of such Unacceptable Waste.

Indemnización. Cliente acuerda indemnizar, mantener inmune, y defender Republic Services, Inc., sus subsidiarios, compañías, divisiones, empleados, oficiales y directores contra de cualquiera y de todas responsabilidades, demandas, penas, pérdidas, juicios, pleitos y los costos incidente además, incluyendo costos de defensa, de acuerdo judicial, y de honorarios razonables del abogado, que pueden ser incurridos en, o como resultado de, la muerte o herida personal a cualquier persona, o daños a cualquier característica, propiedad, contaminación de la tierra o efectos ilícitos en esta Facilidad, causado entero o en parte por el cliente, sus empleados, o sus subcontratistas en botar basura en esta Facilidad. En el caso que el Cliente entrega, bota, basura (según lo determinado por Republic) en este Establecimiento basura inaceptable en los reglamentos de este Establecimiento, el Cliente se compromete asumir todos los costos y obligaciones con el retiro y/o la resolución de cualquier dano(s) causado por la entrega de tal basura inaceptable.



NON-HAZARDOUS WASTE MANIFEST

MANIFEST # 11852

GENERATOR INFORMATION

Generator Name: Tronox LLC

Address: P.O. Box 55

City: Henderson County: Clark

State: NV Zip: 89009

Site Location (if different): 560 W. Lake Mead

Henderson, NV 89015 (702) 592-7727

CUSTOMER/BILLING INFORMATION

Billing Name: NGE LLC c/o Northgate Environment Management

Address: 300 Frank Ogawa Plaza, Ste 510

City: Oakland County: Alameda

State: CA Zip: 94612

Table with 5 columns: Republic Services Approval #, Description of Waste, Volume/Weight, Expiration Date, Container Type. Row 1: 38251011244, Soil for disposal, 34.42 TN, 12-31-2011, Tractor with Dump Trailer(s). Row 2: RZ- #

*Attach Additional Sheet if necessary

I hereby certify that the above-described materials are non-hazardous wastes as defined by 40 CFR 261 or any applicable state law. Further, that the above named materials are properly classified, described, packaged, marked and labeled, and are in proper condition for transportation according to the applicable regulations of the Department of Transportation.

Susan Crowley

Signature of Susan Crowley

Generator/Authorized Agent Name

Signature

Date Shipped

TRANSPORTER INFORMATION

Transporter Name: Las Vegas Paving

DOT # 191949

Address: 4420 S. Decatur

Truck Number: 981

Las Vegas, NV 89103

Phone Number: (702) 353-4355

I certify no hazardous waste or other regulated substance was knowingly introduced to the waste while in my custody. The waste transported in this vehicle is the waste identified above, to the best of my knowledge.

Tom Rawling

Signature of Tom Rawling

10-5-10

Name of Authorized Agent

Signature

Date Delivered

DISPOSAL SITE INFORMATION

Site Name: Apex Regional Landfill

Phone No. (702) 599-5920

Address: 13550 U.S. Hwy 93 Las Vegas, NV

I hereby acknowledge receipt of the above described materials

JASON CARTER

Signature of Jason Carter

10/5/10

Name (Print or Type)

Signature

Date Received

81 Environmental Tech
13550 N Highway 93
Las Vegas, NV 89165

Ticket Type: INBOUND INVOICE

Ticket Number: 1758
Date: 10/05/2010
Time In: 8:10 pm
Time Out: 8:37 pm

Customer: 001011 - NGE, LLC c/o Northgate Environ Mgmt

Vehicle/Container: 86053P

Contract: Northgate Env. On Site Soils 3825 11

Comment: 3825 10 11244

Gross Weight: 122,920 LB Manual In
Tare Weight: 54,700 LB Manual Out
Net Weight: 68220 LB
Net Tons: 34.11

BOL: 11853

Origin	Yards	Material	Billing	Quantity
Not Applicable	0.00 YD	SW CONTAMINATED SOIL	34.11	TN

Driver: _____



Weighmaster: _____

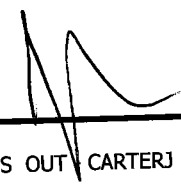

IN - HOLDENS OUT CARTERJ

Indemnification. Customer agrees, by signature above, to indemnify, hold harmless, and defend Republic Services, Inc., its subsidiaries, affiliates, employees, officers and directors from and against any and all liabilities, claims, penalties, forfeitures, suits and the costs and expenses incident thereto, including costs of defense, settlement, and reasonable attorney's fees, which may be incurred, as a result of death or injuries to any person, or damage to any property, contamination of or adverse effects on the environment, caused in whole or in part by the Customer, its employees, or subcontractors in disposing waste at this Facility. In the event Customer delivers Unacceptable Waste (as determined by Republic) Customer agrees to assume all expenses and obligations with the removal and/or resolution of any effects caused by the delivery of such Unacceptable Waste.

Indemnización. Cliente acuerda indemnizar, mantener inmune, y defender Republic Services, Inc., sus subsidiarios, compañías, divisiones, empleados, oficiales y directores contra de cualquiera y de todas responsabilidades, demandas, penas, pérdidas, juicios, pleitos y los costos incidente además, incluyendo costos de defensa, de acuerdo judicial, y de honorarios razonables del abogado, que pueden ser incurridos en, o como resultado de, la muerte o herida personal a cualquier persona, o daños a cualquier característica, propiedad, contaminación de la tierra o efectos ilícitos en esta Facilidad, causado entero o en parte por el cliente, sus empleados, o sus subcontratistas en botar basura en esta Facilidad. En el caso que el Cliente entrega, bota, basura (según lo determinado por Republic) en este Establecimiento basura inaceptable en los reglamentos de este Establecimiento, el Cliente se compromete asumir todos los costos y obligaciones con el retiro y/o la resolución de cualquier dano(s) causado por la entrega de tal basura inaceptable.



NON-HAZARDOUS WASTE MANIFEST

MANIFEST # 11853

GENERATOR INFORMATION

Generator Name: Tronox LLC
Address: P.O. Box 55
City: Henderson County: Clark
State: NV Zip: 89009
Site Location (if different): 560 W. Lake Mead
Henderson, NV 89015 (702) 592-7727

CUSTOMER/BILLING INFORMATION

Billing Name: NGE LLC c/o Northgate Environment Management
Address: 300 Frank Ogawa Plaza, Ste 510
City: Oakland County: Alameda
State: CA Zip: 94612

Table with 5 columns: Republic Services Approval #, Description of Waste, Volume/Weight, Expiration Date, Container Type. Row 1: 38251011244, Soil for disposal, 34.11 TN, 12-31-2011, Tractor with Dump Trailer(s). Row 2: RZ- #

*Attach Additional Sheet if necessary

I hereby certify that the above-described materials are non-hazardous wastes as defined by 40 CFR 261 or any applicable state law. Further, that the above named materials are properly classified, described, packaged, marked and labeled, and are in proper condition for transportation according to the applicable regulations of the Department of Transportation.

Susan Crowley
Generator/Authorized Agent Name Signature Date Shipped

TRANSPORTER INFORMATION

Transporter Name: Las Vegas Paving DOT # 191949
Address: 4420 S. Decatur Truck Number: 261
Las Vegas, NV 89103 Phone Number: (702) 353-4355

I certify no hazardous waste or other regulated substance was knowingly introduced to the waste while in my custody. The waste transported in this vehicle is the waste identified above, to the best of my knowledge.

Name of Authorized Agent Signature Date Delivered
PATRICK ... 5 OCT 10

DISPOSAL SITE INFORMATION

Site Name: Apex Regional Landfill Phone No. (702) 599-5920
Address: 13550 U.S. Hwy 93 Las Vegas, NV

I hereby acknowledge receipt of the above described materials
Name (Print or Type) Signature Date Received
JASON CARTER 10/5/10

81 Environmental Tech
13550 N Highway 93
Las Vegas, NV 89165

Ticket Type: INBOUND INVOICE

Ticket Number: 1759
Date: 10/05/2010
Time In: 8:17 pm
Time Out: 8:39 pm

Customer: 001011 - NGE, LLC c/o Northgate Environ Mgmt

Vehicle/Container: 76810P
Contract: Northgate Env. On Site Soils 3825 11
Comment: 3825 10 11244

Gross Weight: 121,840 LB Manual In
Tare Weight: 54,500 LB Manual Out
Net Weight: 67340 LB
Net Tons: 33.67

BOL: 11855

Origin	Yards	Material	Billing	Quantity
Not Applicable	0.00 YD	SW CONTAMINATED SOIL	33.67	TN

Driver:

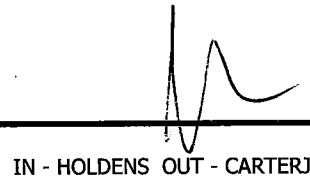

Weighmaster:

IN - HOLDENS OUT - CARTERJ

Indemnification. Customer agrees, by signature above, to indemnify, hold harmless, and defend Republic Services, Inc., its subsidiaries, affiliates, employees, officers and directors from and against any and all liabilities, claims, penalties, forfeitures, suits and the costs and expenses incident thereto, including costs of defense, settlement, and reasonable attorney's fees, which may be incurred, as a result of death or injuries to any person, or damage to any property, contamination of or adverse effects on the environment, caused in whole or in part by the Customer, its employees, or subcontractors in disposing waste at this Facility. In the event Customer delivers Unacceptable Waste (as determined by Republic) Customer agrees to assume all expenses and obligations with the removal and/or resolution of any effects caused by the delivery of such Unacceptable Waste.

Indemnización. Cliente acuerda indemnizar, mantener inmune, y defender Republic Services, Inc., sus subsidiarios, compañías, divisiones, empleados, oficiales y directores contra de cualquiera y de todas responsabilidades, demandas, penas, pérdidas, juicios, pleitos y los costos incidente además, incluyendo costos de defensa, de acuerdo judicial, y de honorarios razonables del abogado, que pueden ser incurridos en, o como resultado de, la muerte o herida personal a cualquier persona, o daños a cualquier característica, propiedad, contaminación de la tierra o efectos ilícitos en esta Facilidad, causado entero o en parte por el cliente, sus empleados, o sus subcontratistas en botar basura en esta Facilidad. En el caso que el Cliente entrega, bota, basura (según lo determinado por Republic) en este Establecimiento basura inaceptable en los reglamentos de este Establecimiento, el Cliente se compromete asumir todos los costos y obligaciones con el retiro y/o la resolución de cualquier dano(s) causado por la entrega de tal basura inaceptable.



NON-HAZARDOUS WASTE MANIFEST

MANIFEST # 11855

GENERATOR INFORMATION

Generator Name: Tronox LLC

Address: P.O. Box 55

City: Henderson County: Clark

State: NV Zip: 89009

Site Location (if different): 560 W. Lake Mead
Henderson, NV 89015 (702) 592-7727

CUSTOMER/BILLING INFORMATION

Billing Name: NGE LLC c/o Northgate Environment Management

Address: 300 Frank Ogawa Plaza, Ste 510

City: Oakland County: Alameda

State: CA Zip: 94612

Table with 5 columns: Republic Services Approval #, Description of Waste, Volume/Weight, Expiration Date, Container Type. Row 1: 38251011244, Soil for disposal, 33.67 TN, 12-31-2011, Tractor with Dump Trailer(s).

*Attach Additional Sheet if necessary

I hereby certify that the above-described materials are non-hazardous wastes as defined by 40 CFR 261 or any applicable state law. Further, that the above named materials are properly classified, described, packaged, marked and labeled, and are in proper condition for transportation according to the applicable regulations of the Department of Transportation.

Susan Crowley (Signature)
Generator/Authorized Agent Name Signature Date Shipped

TRANSPORTER INFORMATION

Transporter Name: Las Vegas Paving

DOT # 191949

Address: 4420 S. Decatur

Truck Number: 241

Las Vegas, NV 89103

Phone Number: (702) 353-4355

I certify no hazardous waste or other regulated substance was knowingly introduced to the waste while in my custody. The waste transported in this vehicle is the waste identified above, to the best of my knowledge.

Ken Jackson (Signature)
Name of Authorized Agent Signature Date Delivered 10-5-2010

DISPOSAL SITE INFORMATION

Site Name: Apex Regional Landfill

Phone No. (702) 599-5920

Address: 13550 U.S. Hwy 93 Las Vegas, NV

I hereby acknowledge receipt of the above described materials

JASON CARTER (Signature)
Name (Print or Type) Signature Date Received 10/5/10

81 Environmental Tech
13550 N Highway 93
Las Vegas, NV 89165

Ticket Type: INBOUND INVOICE

Ticket Number: 1760
Date: 10/05/2010
Time In: 8:20 pm
Time Out: 8:44 pm

Customer: 001011 - NGE, LLC c/o Northgate Environ Mgmt

Vehicle/Container: 44165A
Contract: Northgate Env. On Site Soils 3825 11
Comment: 3825 10 11244

Gross Weight: 127,760 LB Manual In
Tare Weight: 48,920 LB Manual Out
Net Weight: 78840 LB
Net Tons: 39.42

BOL: 11854

Origin	Yards	Material	Billing Quantity
Not Applicable	0.00 YD	SW CONTAMINATED SOIL	39.42 TN

Driver: _____



Weighmaster: _____

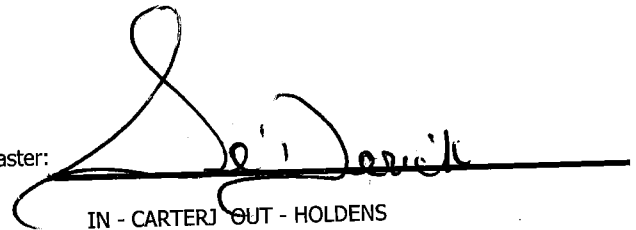

IN - CARTERJ OUT - HOLDENS

Indemnification. Customer agrees, by signature above, to indemnify, hold harmless, and defend Republic Services, Inc., its subsidiaries, affiliates, employees, officers and directors from and against any and all liabilities, claims, penalties, forfeitures, suits and the costs and expenses incident thereto, including costs of defense, settlement, and reasonable attorney's fees, which may be incurred, as a result of death or injuries to any person, or damage to any property, contamination of or adverse effects on the environment, caused in whole or in part by the Customer, its employees, or subcontractors in disposing waste at this Facility. In the event Customer delivers Unacceptable Waste (as determined by Republic) Customer agrees to assume all expenses and obligations with the removal and/or resolution of any effects caused by the delivery of such Unacceptable Waste.

Indemnización. Cliente acuerda indemnizar, mantener inmune, y defender Republic Services, Inc., sus subsidiarios, compañías, divisiones, empleados, oficiales y directores contra de cualquiera y de todas responsabilidades, demandas, penas, pérdidas, juicios, pleitos y los costos incidente además, incluyendo costos de defensa, de acuerdo judicial, y de honorarios razonables del abogado, que pueden ser incurridos en, o como resultado de, la muerte o herida personal a cualquier persona, o daños a cualquier característica, propiedad, contaminación de la tierra o efectos ilícitos en esta Facilidad, causado entero o en parte por el cliente, sus empleados, o sus subcontratistas en botar basura en esta Facilidad. En el caso que el Cliente entrega, bota, basura (según lo determinado por Republic) en este Establecimiento basura inaceptable en los reglamentos de este Establecimiento, el Cliente se compromete asumir todos los costos y obligaciones con el retiro y/o la resolución de cualquier dano(s) causado por la entrega de tal basura inaceptable.



NON-HAZARDOUS WASTE MANIFEST

MANIFEST # 11854

GENERATOR INFORMATION

Generator Name: Tronox LLC

Address: P.O. Box 55

City: Henderson County: Clark

State: NV Zip: 89009

Site Location (if different): 560 W. Lake Mead
Henderson, NV 89015 (702) 592-7727

CUSTOMER/BILLING INFORMATION

Billing Name: NGE LLC c/o Northgate Environment Management

Address: 300 Frank Ogawa Plaza, Ste 510

City: Oakland County: Alameda

State: CA Zip: 94612

Republic Services Approval #	Description of Waste	Volume/Weight	Expiration Date	Container Type
38251011244	Soil for disposal	39 ⁴² / ₁₀₀ tons	12-31-2011	Tractor with Dump Trailer(s)
	RZ- _____ # _____			

*Attach Additional Sheet if necessary

I hereby certify that the above-described materials are non-hazardous wastes as defined by 40 CFR 261 or any applicable state law. Further, that the above named materials are properly classified, described, packaged, marked and labeled, and are in proper condition for transportation according to the applicable regulations of the Department of Transportation.

Susan Crowley [Signature] _____
 Generator/Authorized Agent Name Signature Date Shipped

TRANSPORTER INFORMATION

Transporter Name: Las Vegas Paving

DOT # 191949

Address: 4420 S. Decatur

Truck Number: 1001

Las Vegas, NV 89103

Phone Number: (702) 353-4355

I certify no hazardous waste or other regulated substance was knowingly introduced to the waste while in my custody. The waste transported in this vehicle is the waste identified above, to the best of my knowledge.

[Signature] [Signature] 10-5-10
 Name of Authorized Agent Signature Date Delivered

DISPOSAL SITE INFORMATION

Site Name: Apex Regional Landfill

Phone No. (702) 599-5920

Address: 13550 U.S. Hwy 93 Las Vegas, NV

I hereby acknowledge receipt of the above described materials

Holden, Se Derick [Signature] 05 Oct 10
 Name (Print or Type) Signature Date Received

81 Environmental Tech
13550 N Highway 93
Las Vegas, NV 89165

Ticket Type: INBOUND INVOICE

Ticket Number: 1761
Date: 10/05/2010
Time In: 8:21 pm
Time Out: 8:46 pm

Customer: 001011 - NGE, LLC c/o Northgate Environ Mgmt

Vehicle/Container: 76811P
Contract: Northgate Env. On Site Soils 3825 11
Comment: 3825 10 11244

Gross Weight: 110,660 LB Manual In
Tare Weight: 49,300 LB Manual Out
Net Weight: 61360 LB
Net Tons: 30.68

BOL: 11856

Origin	Yards	Material	Billing Quantity
Not Applicable	0.00 YD	SW CONTAMINATED SOIL	30.68 TN

Driver:

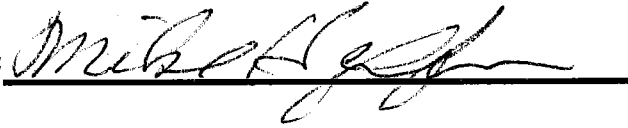

Weighmaster:

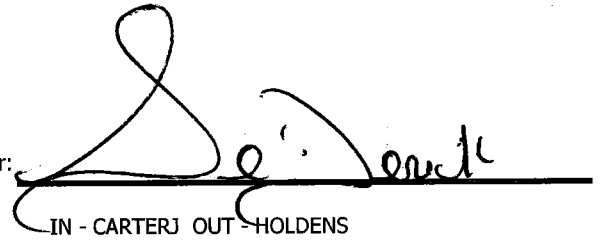

IN - CARTERJ OUT - HOLDENS

Indemnification. Customer agrees, by signature above, to indemnify, hold harmless, and defend Republic Services, Inc., its subsidiaries, affiliates, employees, officers and directors from and against any and all liabilities, claims, penalties, forfeitures, suits and the costs and expenses incident thereto, including costs of defense, settlement, and reasonable attorney's fees, which may be incurred, as a result of death or injuries to any person, or damage to any property, contamination of or adverse effects on the environment, caused in whole or in part by the Customer, its employees, or subcontractors in disposing waste at this Facility. In the event Customer delivers Unacceptable Waste (as determined by Republic) Customer agrees to assume all expenses and obligations with the removal and/or resolution of any effects caused by the delivery of such Unacceptable Waste.

Indemnización. Cliente acuerda indemnizar, mantener inmune, y defender Republic Services, Inc., sus subsidiarios, compañías, divisiones, empleados, oficiales y directores contra de cualquiera y de todas responsabilidades, demandas, penas, pérdidas, juicios, pleitos y los costos incidente además, incluyendo costos de defensa, de acuerdo judicial, y de honorarios razonables del abogado, que pueden ser incurridos en, o como resultado de, la muerte o herida personal a cualquier persona, o daños a cualquier característica, propiedad, contaminación de la tierra o efectos ilícitos en esta Facilidad, causado entero o en parte por el cliente, sus empleados, o sus subcontratistas en botar basura en esta Facilidad. En el caso que el Cliente entrega, bota, basura (según lo determinado por Republic) en este Establecimiento basura inaceptable en los reglamentos de este Establecimiento, el Cliente se compromete asumir todos los costos y obligaciones con el retiro y/o la resolución de cualquier dano(s) causado por la entrega de tal basura inaceptable.



NON-HAZARDOUS WASTE MANIFEST

MANIFEST # 11856

GENERATOR INFORMATION

Generator Name: Tronox LLC

Address: P.O. Box 55

City: Henderson County: Clark

State: NV Zip: 89009

Site Location (if different): 560 W. Lake Mead

Henderson, NV 89015 (702) 592-7727

CUSTOMER/BILLING INFORMATION

Billing Name: NGE LLC c/o Northgate Environment Management

Address: 300 Frank Ogawa Plaza, Ste 510

City: Oakland County: Alameda

State: CA Zip: 94612

Republic Services Approval #	Description of Waste	Volume/Weight	Expiration Date	Container Type
38251011244	Soil for disposal	30 ⁶³ / _{ton}	12-31-2011	Tractor with Dump Trailer(s)
	RZ- _____ # _____			

*Attach Additional Sheet if necessary

I hereby certify that the above-described materials are non-hazardous wastes as defined by 40 CFR 261 or any applicable state law. Further, that the above named materials are properly classified, described, packaged, marked and labeled, and are in proper condition for transportation according to the applicable regulations of the Department of Transportation.

Susan Crowley (Signature) Generator/Authorized Agent Name Signature Date Shipped

TRANSPORTER INFORMATION

Transporter Name: Las Vegas Paving

DOT # 191949

Address: 4420 S. Decatur

Truck Number: 242

Las Vegas, NV 89103

Phone Number: (702) 353-4355

I certify no hazardous waste or other regulated substance was knowingly introduced to the waste while in my custody. The waste transported in this vehicle is the waste identified above, to the best of my knowledge.

Mike Heffernan (Signature) Name of Authorized Agent Signature Date Delivered 10-5-10

DISPOSAL SITE INFORMATION

Site Name: Apex Regional Landfill

Phone No. (702) 599-5920

Address: 13550 U.S. Hwy 93 Las Vegas, NV

I hereby acknowledge receipt of the above described materials (Signature) Name (Print or Type) Signature Date Received 05 Oct 10

81 Environmental Tech
13550 N Highway 93
Las Vegas, NV 89165

Ticket Type: INBOUND INVOICE

Ticket Number: 1762
Date: 10/05/2010
Time In: 8:30 pm
Time Out: 8:56 pm

Customer: 001011 - NGE, LLC c/o Northgate Environ Mgmt

Vehicle/Container: 44166A
Contract: Northgate Env. On Site Soils 3825 11
Comment: 3825 10 11244

Gross Weight: 138,460 LB Manual In
Tare Weight: 57,600 LB Manual Out
Net Weight: 80860 LB
Net Tons: 40.43

BOL: 11857

Origin	Yards	Material	Billing	Quantity
Not Applicable	0.00 YD	SW CONTAMINATED SOIL	40.43	TN

Driver: _____

Weighmaster: _____

CARTERJ

Indemnification. Customer agrees, by signature above, to indemnify, hold harmless, and defend Republic Services, Inc., its subsidiaries, affiliates, employees, officers and directors from and against any and all liabilities, claims, penalties, forfeitures, suits and the costs and expenses incident thereto, including costs of defense, settlement, and reasonable attorney's fees, which may be incurred, as a result of death or injuries to any person, or damage to any property, contamination of or adverse effects on the environment, caused in whole or in part by the Customer, its employees, or subcontractors in disposing waste at this Facility. In the event Customer delivers Unacceptable Waste (as determined by Republic) Customer agrees to assume all expenses and obligations with the removal and/or resolution of any effects caused by the delivery of such Unacceptable Waste.

Indemnización. Cliente acuerda indemnizar, mantener inmune, y defender Republic Services, Inc., sus subsidiarios, compañías, divisiones, empleados, oficiales y directores contra de cualquiera y de todas responsabilidades, demandas, penas, pérdidas, juicios, pleitos y los costos incidente además, incluyendo costos de defensa, de acuerdo judicial, y de honorarios razonables del abogado, que pueden ser incurridos en, o como resultado de, la muerte o herida personal a cualquier persona, o daños a cualquier característica, propiedad, contaminación de la tierra o efectos ilícitos en esta Facilidad, causado entero o en parte por el cliente, sus empleados, o sus subcontratistas en botar basura en esta Facilidad. En el caso que el Cliente entrega, bota, basura (según lo determinado por Republic) en este Establecimiento basura inaceptable en los reglamentos de este Establecimiento, el Cliente se compromete asumir todos los costos y obligaciones con el retiro y/o la resolución de cualquier dano(s) causado por la entrega de tal basura inaceptable.



NON-HAZARDOUS WASTE MANIFEST

MANIFEST # 11857

GENERATOR INFORMATION

Generator Name: Tronox LLC
Address: P.O. Box 55
City: Henderson County: Clark
State: NV Zip: 89009
Site Location (if different): 560 W. Lake Mead
Henderson, NV 89015 (702) 592-7727

CUSTOMER/BILLING INFORMATION

Billing Name: NGE LLC c/o Northgate Environment Management
Address: 300 Frank Ogawa Plaza, Ste 510
City: Oakland County: Alameda
State: CA Zip: 94612

Table with 5 columns: Republic Services Approval #, Description of Waste, Volume/Weight, Expiration Date, Container Type. Row 1: 38251011244, Soil for disposal, 410.43 TN, 12-31-2011, Tractor with Dump Trailer(s). Row 2: RZ- #

*Attach Additional Sheet if necessary

I hereby certify that the above-described materials are non-hazardous wastes as defined by 40 CFR 261 or any applicable state law. Further, that the above named materials are properly classified, described, packaged, marked and labeled, and are in proper condition for transportation according to the applicable regulations of the Department of Transportation.

Susan Crowley (Signature)
Generator/Authorized Agent Name Signature Date Shipped

TRANSPORTER INFORMATION

Transporter Name: Las Vegas Paving DOT # 191949
Address: 4420 S. Decatur Truck Number: K002
Las Vegas, NV 89103 Phone Number: (702) 353-4355

I certify no hazardous waste or other regulated substance was knowingly introduced to the waste while in my custody. The waste transported in this vehicle is the waste identified above, to the best of my knowledge.

Hugo Castillo (Signature)
Name of Authorized Agent Signature Date Delivered 10-5-10

DISPOSAL SITE INFORMATION

Site Name: Apex Regional Landfill Phone No. (702) 599-5920
Address: 13550 U.S. Hwy 93 Las Vegas, NV

I hereby acknowledge receipt of the above described materials
Name (Print or Type) Signature Date Received 10/5/10

81 Environmental Tech
13550 N Highway 93
Las Vegas, NV 89165

Ticket Type: INBOUND INVOICE

Ticket Number: 1763
Date: 10/05/2010
Time In: 8:31 pm
Time Out: 8:59 pm

Customer: 001011 - NGE, LLC c/o Northgate Environ Mgmt

Vehicle/Container: 86113P
Contract: Northgate Env. On Site Soils 3825 11
Comment: 3825 10 11244

Gross Weight: 131,980 LB Manual In
Tare Weight: 55,680 LB Manual Out
Net Weight: 76300 LB
Net Tons: 38.15

BOL: 11858

Origin	Yards	Material	Billing Quantity
Not Applicable	0.00 YD	SW CONTAMINATED SOIL	38.15 TN

Driver: _____



Weighmaster: _____

CARTERJ 

Indemnification. Customer agrees, by signature above, to indemnify, hold harmless, and defend Republic Services, Inc., its subsidiaries, affiliates, employees, officers and directors from and against any and all liabilities, claims, penalties, forfeitures, suits and the costs and expenses incident thereto, including costs of defense, settlement, and reasonable attorney's fees, which may be incurred, as a result of death or injuries to any person, or damage to any property, contamination of or adverse effects on the environment, caused in whole or in part by the Customer, its employees, or subcontractors in disposing waste at this Facility. In the event Customer delivers Unacceptable Waste (as determined by Republic) Customer agrees to assume all expenses and obligations with the removal and/or resolution of any effects caused by the delivery of such Unacceptable Waste.

Indemnización. Cliente acuerda indemnizar, mantener inmune, y defender Republic Services, Inc., sus subsidiarios, compañías, divisiones, empleados, oficiales y directores contra de cualquiera y de todas responsabilidades, demandas, penas, pérdidas, juicios, pleitos y los costos incidente además, incluyendo costos de defensa, de acuerdo judicial, y de honorarios razonables del abogado, que pueden ser incurridos en, o como resultado de, la muerte o herida personal a cualquier persona, o daños a cualquier característica, propiedad, contaminación de la tierra o efectos ilícitos en esta Facilidad, causado entero o en parte por el cliente, sus empleados, o sus subcontratistas en botar basura en esta Facilidad. En el caso que el Cliente entrega, bota, basura (según lo determinado por Republic) en este Establecimiento basura inaceptable en los reglamentos de este Establecimiento, el Cliente se compromete asumir todos los costos y obligaciones con el retiro y/o la resolución de cualquier dano(s) causado por la entrega de tal basura inaceptable.



NON-HAZARDOUS WASTE MANIFEST

MANIFEST # 11858

GENERATOR INFORMATION

Generator Name: Tronox LLC
Address: P.O. Box 55
City: Henderson County: Clark
State: NV Zip: 89009
Site Location (if different): 560 W. Lake Mead
Henderson, NV 89015 (702) 592-7727

CUSTOMER/BILLING INFORMATION

Billing Name: NGE LLC c/o Northgate Environment Management
Address: 300 Frank Ogawa Plaza, Ste 510
City: Oakland County: Alameda
State: CA Zip: 94612

Table with 5 columns: Republic Services Approval #, Description of Waste, Volume/Weight, Expiration Date, Container Type. Row 1: 38251011244, Soil for disposal, 38.15 TN, 12-31-2011, Tractor with Dump Trailer(s). Row 2: RZ- #

*Attach Additional Sheet if necessary

I hereby certify that the above-described materials are non-hazardous wastes as defined by 40 CFR 261 or any applicable state law. Further, that the above named materials are properly classified, described, packaged, marked and labeled, and are in proper condition for transportation according to the applicable regulations of the Department of Transportation.

Susan Crowley
Generator/Authorized Agent Name Signature Date Shipped

TRANSPORTER INFORMATION

Transporter Name: Las Vegas Paving DOT # 191949
Address: 4420 S. Decatur Truck Number: K001A/7
Las Vegas, NV 89103 Phone Number: (702) 353-4355

I certify no hazardous waste or other regulated substance was knowingly introduced to the waste while in my custody. The waste transported in this vehicle is the waste identified above, to the best of my knowledge.

ALBERTO
Name of Authorized Agent Signature Date Delivered OCT 5, 2010

DISPOSAL SITE INFORMATION

Site Name: Apex Regional Landfill Phone No. (702) 599-5920
Address: 13550 U.S. Hwy 93 Las Vegas, NV

I hereby acknowledge receipt of the above described materials

JASON CARTER
Name (Print or Type) Signature Date Received 10/5/10

REPRINT

81 Environmental Tech
13550 N Highway 93
Las Vegas, NV 89165

Ticket Type: INBOUND INVOICE

Ticket Number: 1764
Date: 10/05/2010
Time In: 8:36 pm
Time Out: 9:01 pm

Customer: 001011 - NGE, LLC c/o Northgate Environ Mgmt

Vehicle/Container: 68263P
Contract: Northgate Env. On Site Soils 3825 11
Comment: 3825 10 11244

Gross Weight: 129,420 LB Manual In
Tare Weight: 53,740 LB Manual Out
Net Weight: 75680 LB
Net Tons: 37.84

BOL: 11859

Origin	Yards	Material	Billing	Quantity
Not Applicable	0.00 YD	SW CONTAMINATED SOIL	37.84	TN

Driver: _____

Weighmaster: _____

CARTERJ

Indemnification. Customer agrees, by signature above, to indemnify, hold harmless, and defend Republic Services, Inc., its subsidiaries, affiliates, employees, officers and directors from and against any and all liabilities, claims, penalties, forfeitures, suits and the costs and expenses incident thereto, including costs of defense, settlement, and reasonable attorney's fees, which may be incurred, as a result of death or injuries to any person, or damage to any property, contamination of or adverse effects on the environment, caused in whole or in part by the Customer, its employees, or subcontractors in disposing waste at this Facility. In the event Customer delivers Unacceptable Waste (as determined by Republic) Customer agrees to assume all expenses and obligations with the removal and/or resolution of any effects caused by the delivery of such Unacceptable Waste.

Indemnización. Cliente acuerda indemnizar, mantener inmune, y defender Republic Services, Inc., sus subsidiarios, compañías, divisiones, empleados, oficiales y directores contra de cualquiera y de todas responsabilidades, demandas, penas, pérdidas, juicios, pleitos y los costos incidente además, incluyendo costos de defensa, de acuerdo judicial, y de honorarios razonables del abogado, que pueden ser incurridos en, o como resultado de, la muerte o herida personal a cualquier persona, o daños a cualquier característica, propiedad, contaminación de la tierra o efectos ilícitos en esta Facilidad, causado entero o en parte por el cliente, sus empleados, o sus subcontratistas en botar basura en esta Facilidad. En el caso que el Cliente entrega, bota, basura (según lo determinado por Republic) en este Establecimiento basura inaceptable en los reglamentos de este Establecimiento, el Cliente se compromete asumir todos los costos y obligaciones con el retiro y/o la resolución de cualquier dano(s) causado por la entrega de tal basura inaceptable.



NON-HAZARDOUS WASTE MANIFEST

MANIFEST # 11859

GENERATOR INFORMATION

Generator Name: Tronox LLC
Address: P.O. Box 55
City: Henderson County: Clark
State: NV Zip: 89009
Site Location (if different): 560 W. Lake Mead
Henderson, NV 89015 (702) 592-7727

CUSTOMER/BILLING INFORMATION

Billing Name: NGE LLC c/o Northgate Environment Management
Address: 300 Frank Ogawa Plaza, Ste 510
City: Oakland County: Alameda
State: CA Zip: 94612

Table with 5 columns: Republic Services Approval #, Description of Waste, Volume/Weight, Expiration Date, Container Type. Row 1: 38251011244, Soil for disposal, 37.84 TN, 12-31-2011, Tractor with Dump Trailer(s). Row 2: RZ- #

*Attach Additional Sheet if necessary

I hereby certify that the above-described materials are non-hazardous wastes as defined by 40 CFR 261 or any applicable state law. Further, that the above named materials are properly classified, described, packaged, marked and labeled, and are in proper condition for transportation according to the applicable regulations of the Department of Transportation.

Susan Crowley (Signature)
Generator/Authorized Agent Name Signature Date Shipped

TRANSPORTER INFORMATION

Transporter Name: Las Vegas Paving DOT # 191949
Address: 4420 S. Decatur Truck Number: 2711
Las Vegas, NV 89103 Phone Number: (702) 353-4355

I certify no hazardous waste or other regulated substance was knowingly introduced to the waste while in my custody. The waste transported in this vehicle is the waste identified above, to the best of my knowledge.

STEVEN HAYES (Signature)
Name of Authorized Agent Signature Date Delivered 10-5-10

DISPOSAL SITE INFORMATION

Site Name: Apex Regional Landfill Phone No. (702) 599-5920
Address: 13550 U.S. Hwy 93 Las Vegas, NV

I hereby acknowledge receipt of the above described materials

JASON CARTER (Signature)
Name (Print or Type) Signature Date Received 10/5/10

81 Environmental Tech
13550 N Highway 93
Las Vegas, NV 89165

Ticket Type: INBOUND INVOICE

Ticket Number: 1765
Date: 10/05/2010
Time In: 8:39 pm
Time Out: 9:07 pm

Customer: 001011 - NGE, LLC c/o Northgate Environ Mgmt

Vehicle/Container: 81460P
Contract: Northgate Env. On Site Soils 3825 11
Comment: 3825 10 11244

Gross Weight: 120,900 LB Manual In
Tare Weight: 52,880 LB Manual Out
Net Weight: 68020 LB
Net Tons: 34.01

BOL: 11860

Origin	Yards	Material	Billing	Quantity
Not Applicable	0.00 YD	SW CONTAMINATED SOIL	34.01	TN

Driver: _____

Weighmaster: _____

CARTERJ

Indemnification. Customer agrees, by signature above, to indemnify, hold harmless, and defend Republic Services, Inc., its subsidiaries, affiliates, employees, officers and directors from and against any and all liabilities, claims, penalties, forfeitures, suits and the costs and expenses incident thereto, including costs of defense, settlement, and reasonable attorney's fees, which may be incurred, as a result of death or injuries to any person, or damage to any property, contamination of or adverse effects on the environment, caused in whole or in part by the Customer, its employees, or subcontractors in disposing waste at this Facility. In the event Customer delivers Unacceptable Waste (as determined by Republic) Customer agrees to assume all expenses and obligations with the removal and/or resolution of any effects caused by the delivery of such Unacceptable Waste.

Indemnización. Cliente acuerda indemnizar, mantener inmune, y defender Republic Services, Inc., sus subsidiarios, compañías, divisiones, empleados, oficiales y directores contra de cualquiera y de todas responsabilidades, demandas, penas, pérdidas, juicios, pleitos y los costos incidente además, incluyendo costos de defensa, de acuerdo judicial, y de honorarios razonables del abogado, que pueden ser incurridos en, o como resultado de, la muerte o herida personal a cualquier persona, o daños a cualquier característica, propiedad, contaminación de la tierra o efectos ilícitos en esta Facilidad, causado entero o en parte por el cliente, sus empleados, o sus subcontratistas en botar basura en esta Facilidad. En el caso que el Cliente entrega, bota, basura (según lo determinado por Republic) en este Establecimiento basura inaceptable en los reglamentos de este Establecimiento, el Cliente se compromete asumir todos los costos y obligaciones con el retiro y/o la resolución de cualquier dano(s) causado por la entrega de tal basura inaceptable.



NON-HAZARDOUS WASTE MANIFEST

MANIFEST # 11860

GENERATOR INFORMATION

Generator Name: Tronox LLC

Address: P.O. Box 55

City: Henderson County: Clark

State: NV Zip: 89009

Site Location (if different): 560 W. Lake Mead

Henderson, NV 89015 (702) 592-7727

CUSTOMER/BILLING INFORMATION

Billing Name: NGE LLC c/o Northgate Environment Management

Address: 300 Frank Ogawa Plaza, Ste 510

City: Oakland County: Alameda

State: CA Zip: 94612

Republic Services Approval #	Description of Waste	Volume/Weight	Expiration Date	Container Type
38251011244	Soil for disposal	34.01 TN	12-31-2011	Tractor with Dump Trailer(s)
	RZ- _____ # _____			

*Attach Additional Sheet if necessary

I hereby certify that the above-described materials are non-hazardous wastes as defined by 40 CFR 261 or any applicable state law. Further, that the above named materials are properly classified, described, packaged, marked and labeled, and are in proper condition for transportation according to the applicable regulations of the Department of Transportation.

Susan Crowley Generator/Authorized Agent Name Signature Date Shipped

TRANSPORTER INFORMATION

Transporter Name: Las Vegas Paving

DOT # 191949

Address: 4420 S. Decatur

Truck Number: 27

Las Vegas, NV 89103

Phone Number: (702) 353-4355

I certify no hazardous waste or other regulated substance was knowingly introduced to the waste while in my custody. The waste transported in this vehicle is the waste identified above, to the best of my knowledge.

Daniel Cardenas Name of Authorized Agent Signature Date Delivered 10-5-2010

DISPOSAL SITE INFORMATION

Site Name: Apex Regional Landfill

Phone No. (702) 599-5920

Address: 13550 U.S. Hwy 93 Las Vegas, NV

I hereby acknowledge receipt of the above described materials

JASON CARTEC Name (Print or Type) Signature Date Received 10/5/10

81 Environmental Tech
13550 N Highway 93
Las Vegas, NV 89165

Ticket Type: INBOUND INVOICE

Ticket Number: 1766
Date: 10/05/2010
Time In: 9:04 pm
Time Out: 9:33 pm

Customer: 001011 - NGE, LLC c/o Northgate Environ Mgmt

Vehicle/Container: 44564A
Contract: Northgate Env. On Site Soils 3825 11
Comment: 3825 10 11244

Gross Weight: 125,140 LB Manual In
Tare Weight: 49,500 LB Manual Out
Net Weight: 75640 LB
Net Tons: 37.82

BOL: 11862

Origin	Yards	Material	Billing	Quantity
Not Applicable	0.00 YD	SW CONTAMINATED SOIL	37.82	TN

Driver:



Weighmaster:

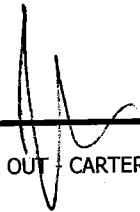

IN - HOLDENS OUT - CARTERJ

Indemnification. Customer agrees, by signature above, to indemnify, hold harmless, and defend Republic Services, Inc., its subsidiaries, affiliates, employees, officers and directors from and against any and all liabilities, claims, penalties, forfeitures, suits and the costs and expenses incident thereto, including costs of defense, settlement, and reasonable attorney's fees, which may be incurred, as a result of death or injuries to any person, or damage to any property, contamination of or adverse effects on the environment, caused in whole or in part by the Customer, its employees, or subcontractors in disposing waste at this Facility. In the event Customer delivers Unacceptable Waste (as determined by Republic) Customer agrees to assume all expenses and obligations with the removal and/or resolution of any effects caused by the delivery of such Unacceptable Waste.

Indemnización. Cliente acuerda indemnizar, mantener inmune, y defender Republic Services, Inc., sus subsidiarios, compañías, divisiones, empleados, oficiales y directores contra de cualquiera y de todas responsabilidades, demandas, penas, pérdidas, juicios, pleitos y los costos incidente además, incluyendo costos de defensa, de acuerdo judicial, y de honorarios razonables del abogado, que pueden ser incurridos en, o como resultado de, la muerte o herida personal a cualquier persona, o daños a cualquier característica, propiedad, contaminación de la tierra o efectos ilícitos en esta Facilidad, causado entero o en parte por el cliente, sus empleados, o sus subcontratistas en botar basura en esta Facilidad. En el caso que el Cliente entrega, bota, basura (según lo determinado por Republic) en este Establecimiento basura inaceptable en los reglamentos de este Establecimiento, el Cliente se compromete asumir todos los costos y obligaciones con el retiro y/o la resolución de cualquier dano(s) causado por la entrega de tal basura inaceptable.



NON-HAZARDOUS WASTE MANIFEST

MANIFEST # 11862

GENERATOR INFORMATION

Generator Name: Tronox LLC

Address: P.O. Box 55

City: Henderson County: Clark

State: NV Zip: 89009

Site Location (if different): 560 W. Lake Mead

Henderson, NV 89015 (702) 592-7727

CUSTOMER/BILLING INFORMATION

Billing Name: NGE LLC c/o Northgate Environment Management

Address: 300 Frank Ogawa Plaza, Ste 510

City: Oakland County: Alameda

State: CA Zip: 94612

Table with 5 columns: Republic Services Approval #, Description of Waste, Volume/Weight, Expiration Date, Container Type. Row 1: 38251011244, Soil for disposal, 37.82 TN, 12-31-2011, Tractor with Dump Trailer(s). Row 2: RZ- #

*Attach Additional Sheet if necessary

I hereby certify that the above-described materials are non-hazardous wastes as defined by 40 CFR 261 or any applicable state law. Further, that the above named materials are properly classified, described, packaged, marked and labeled, and are in proper condition for transportation according to the applicable regulations of the Department of Transportation.

Susan Crowley (Signature) Date Shipped

TRANSPORTER INFORMATION

Transporter Name: Las Vegas Paving DOT # 191949
Address: 4420 S. Decatur Truck Number: K003
Las Vegas, NV 89103 Phone Number: (702) 353-4355

I certify no hazardous waste or other regulated substance was knowingly introduced to the waste while in my custody. The waste transported in this vehicle is the waste identified above, to the best of my knowledge.

CEBU (Signature) Date Delivered 10/05/10

DISPOSAL SITE INFORMATION

Site Name: Apex Regional Landfill Phone No. (702) 599-5920
Address: 13550 U.S. Hwy 93 Las Vegas, NV

I hereby acknowledge receipt of the above described materials
JASON CARPIS (Signature) Date Received 10/5/10

81 Environmental Tech
13550 N Highway 93
Las Vegas, NV 89165

Ticket Type: INBOUND INVOICE

Ticket Number: 1767
Date: 10/05/2010
Time In: 9:06 pm
Time Out: 9:34 pm

Customer: 001011 - NGE, LLC c/o Northgate Environ Mgmt

Vehicle/Container: 85887P
Contract: Northgate Env. On Site Soils 3825 11
Comment: 3825 10 11244

Gross Weight: 122,840 LB Manual In
Tare Weight: 50,740 LB Manual Out
Net Weight: 72100 LB
Net Tons: 36.05

BOL: 11861

Origin	Yards	Material	Billing	Quantity
Not Applicable	0.00 YD	SW CONTAMINATED SOIL	36.05	TN

Driver:

Miguel Rojas

Weighmaster:

[Signature]
IN - HOLDENS OUT - CARTERJ

Indemnification. Customer agrees, by signature above, to indemnify, hold harmless, and defend Republic Services, Inc., its subsidiaries, affiliates, employees, officers and directors from and against any and all liabilities, claims, penalties, forfeitures, suits and the costs and expenses incident thereto, including costs of defense, settlement, and reasonable attorney's fees, which may be incurred, as a result of death or injuries to any person, or damage to any property, contamination of or adverse effects on the environment, caused in whole or in part by the Customer, its employees, or subcontractors in disposing waste at this Facility. In the event Customer delivers Unacceptable Waste (as determined by Republic) Customer agrees to assume all expenses and obligations with the removal and/or resolution of any effects caused by the delivery of such Unacceptable Waste.

Indemnización. Cliente acuerda indemnizar, mantener inmune, y defender Republic Services, Inc., sus subsidiarios, compañías, divisiones, empleados, oficiales y directores contra de cualquiera y de todas responsabilidades, demandas, penas, pérdidas, juicios, pleitos y los costos incidente además, incluyendo costos de defensa, de acuerdo judicial, y de honorarios razonables del abogado, que pueden ser incurridos en, o como resultado de, la muerte o herida personal a cualquier persona, o daños a cualquier característica, propiedad, contaminación de la tierra o efectos ilícitos en esta Facilidad, causado entero o en parte por el cliente, sus empleados, o sus subcontratistas en botar basura en esta Facilidad. En el caso que el Cliente entrega, bota, basura (según lo determinado por Republic) en este Establecimiento basura inaceptable en los reglamentos de este Establecimiento, el Cliente se compromete asumir todos los costos y obligaciones con el retiro y/o la resolución de cualquier dano(s) causado por la entrega de tal basura inaceptable.



NON-HAZARDOUS WASTE MANIFEST

MANIFEST # 11861

GENERATOR INFORMATION

Generator Name: Tronox LLC

Address: P.O. Box 55

City: Henderson County: Clark

State: NV Zip: 89009

Site Location (if different): 560 W. Lake Mead

Henderson, NV 89015 (702) 592-7727

CUSTOMER/BILLING INFORMATION

Billing Name: NGE LLC c/o Northgate Environment Management

Address: 300 Frank Ogawa Plaza, Ste 510

City: Oakland County: Alameda

State: CA Zip: 94612

Republic Services Approval #	Description of Waste	Volume/Weight	Expiration Date	Container Type
38251011244	Soil for disposal	36.05 TN	12-31-2011	Tractor with Dump Trailer(s)
	RZ- _____ # _____			

*Attach Additional Sheet if necessary

I hereby certify that the above-described materials are non-hazardous wastes as defined by 40 CFR 261 or any applicable state law. Further, that the above named materials are properly classified, described, packaged, marked and labeled, and are in proper condition for transportation according to the applicable regulations of the Department of Transportation.

Susan Crowley (Signature) Date Shipped

TRANSPORTER INFORMATION

Transporter Name: Las Vegas Paving

DOT # 191949

Address: 4420 S. Decatur

Truck Number: R01

Las Vegas, NV 89103

Phone Number: (702) 353-4355

I certify no hazardous waste or other regulated substance was knowingly introduced to the waste while in my custody. The waste transported in this vehicle is the waste identified above, to the best of my knowledge.

Name of Authorized Agent (Signature) Date Delivered: 10-05-2010

DISPOSAL SITE INFORMATION

Site Name: Apex Regional Landfill

Phone No. (702) 599-5920

Address: 13550 U.S. Hwy 93 Las Vegas, NV

I hereby acknowledge receipt of the above described materials JASON CARTER (Signature) Date Received: 10/5/10

81 Environmental Tech
13550 N Highway 93
Las Vegas, NV 89165

Ticket Type: INBOUND INVOICE

Ticket Number: 1768
Date: 10/05/2010
Time In: 9:30 pm
Time Out: 9:57 pm

Customer: 001011 - NGE, LLC c/o Northgate Environ Mgmt

Vehicle/Container: 192457
Contract: Northgate Env. On Site Soils 3825 11
Comment: 3825 10 11244

Gross Weight: 122,580 LB Manual In
Tare Weight: 52,440 LB Manual Out
Net Weight: 70140 LB
Net Tons: 35.07

BOL: 11863

Origin	Yards	Material	Billing	Quantity
Not Applicable	0.00 YD	SW CONTAMINATED SOIL	35.07	TN

Driver:

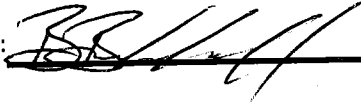

Weighmaster:



HOLDENS

Indemnification. Customer agrees, by signature above, to indemnify, hold harmless, and defend Republic Services, Inc., its subsidiaries, affiliates, employees, officers and directors from and against any and all liabilities, claims, penalties, forfeitures, suits and the costs and expenses incident thereto, including costs of defense, settlement, and reasonable attorney's fees, which may be incurred, as a result of death or injuries to any person, or damage to any property, contamination of or adverse effects on the environment, caused in whole or in part by the Customer, its employees, or subcontractors in disposing waste at this Facility. In the event Customer delivers Unacceptable Waste (as determined by Republic) Customer agrees to assume all expenses and obligations with the removal and/or resolution of any effects caused by the delivery of such Unacceptable Waste.

Indemnización. Cliente acuerda indemnizar, mantener inmune, y defender Republic Services, Inc., sus subsidiarios, compañías, divisiones, empleados, oficiales y directores contra de cualquiera y de todas responsabilidades, demandas, penas, pérdidas, juicios, pleitos y los costos incidente además, incluyendo costos de defensa, de acuerdo judicial, y de honorarios razonables del abogado, que pueden ser incurridos en, o como resultado de, la muerte o herida personal a cualquier persona, o daños a cualquier característica, propiedad, contaminación de la tierra o efectos ilícitos en esta Facilidad, causado entero o en parte por el cliente, sus empleados, o sus subcontratistas en botar basura en esta Facilidad. En el caso que el Cliente entrega, bota, basura (según lo determinado por Republic) en este Establecimiento basura inaceptable en los reglamentos de este Establecimiento, el Cliente se compromete asumir todos los costos y obligaciones con el retiro y/o la resolución de cualquier dano(s) causado por la entrega de tal basura inaceptable.



NON-HAZARDOUS WASTE MANIFEST

MANIFEST # 11863

GENERATOR INFORMATION

Generator Name: Tronox LLC

Address: P.O. Box 55

City: Henderson County: Clark

State: NV Zip: 89009

Site Location (if different): 560 W. Lake Mead
Henderson, NV 89015 (702) 592-7727

CUSTOMER/BILLING INFORMATION

Billing Name: NGE LLC c/o Northgate Environment Management

Address: 300 Frank Ogawa Plaza, Ste 510

City: Oakland County: Alameda

State: CA Zip: 94612

Table with 5 columns: Republic Services Approval #, Description of Waste, Volume/Weight, Expiration Date, Container Type. Row 1: 38251011244, Soil for disposal, 35 07/10, 12-31-2011, Tractor with Dump Trailer(s).

*Attach Additional Sheet if necessary

I hereby certify that the above-described materials are non-hazardous wastes as defined by 40 CFR 261 or any applicable state law. Further, that the above named materials are properly classified, described, packaged, marked and labeled, and are in proper condition for transportation according to the applicable regulations of the Department of Transportation.

Susan Crowley (Signature)
Generator/Authorized Agent Name Signature Date Shipped

TRANSPORTER INFORMATION

Transporter Name: Las Vegas Paving

DOT # 191949

Address: 4420 S. Decatur

Truck Number: 1982157

Las Vegas, NV 89103

Phone Number: (702) 353-4355

I certify no hazardous waste or other regulated substance was knowingly introduced to the waste while in my custody. The waste transported in this vehicle is the waste identified above, to the best of my knowledge.

Brian Brummerhoff (Signature)
Name of Authorized Agent Signature Date Delivered 10-5-10

DISPOSAL SITE INFORMATION

Site Name: Apex Regional Landfill

Phone No. (702) 599-5920

Address: 13550 U.S. Hwy 93 Las Vegas, NV

Hoblen Se' Derek (Signature)
Name (Print or Type) Signature Date Received 05 Oct 10

81 Environmental Tech
13550 N Highway 93
Las Vegas, NV 89165

Ticket Type: INBOUND INVOICE

Ticket Number: 1769
Date: 10/05/2010
Time In: 9:36 pm
Time Out: 10:03 pm

Customer: 001011 - NGE, LLC c/o Northgate Environ Mgmt

Vehicle/Container: 192456
Contract: Northgate Env. On Site Soils 3825 11
Comment: 3825 10 11244

Gross Weight: 122,820 LB Manual In
Tare Weight: 52,980 LB Manual Out
Net Weight: 69840 LB
Net Tons: 34.92

BOL: 11864

Origin	Yards	Material	Billing	Quantity
Not Applicable	0.00 YD	SW CONTAMINATED SOIL	34.92	TN

Driver: _____

Weighmaster: _____

IN - CARTERJ OUT - HOLDENS

Indemnification. Customer agrees, by signature above, to indemnify, hold harmless, and defend Republic Services, Inc., its subsidiaries, affiliates, employees, officers and directors from and against any and all liabilities, claims, penalties, forfeitures, suits and the costs and expenses incident thereto, including costs of defense, settlement, and reasonable attorney's fees, which may be incurred, as a result of death or injuries to any person, or damage to any property, contamination of or adverse effects on the environment, caused in whole or in part by the Customer, its employees, or subcontractors in disposing waste at this Facility. In the event Customer delivers Unacceptable Waste (as determined by Republic) Customer agrees to assume all expenses and obligations with the removal and/or resolution of any effects caused by the delivery of such Unacceptable Waste.

Indemnización. Cliente acuerda indemnizar, mantener inmune, y defender Republic Services, Inc., sus subsidiarios, compañías, divisiones, empleados, oficiales y directores contra de cualquiera y de todas responsabilidades, demandas, penas, pérdidas, juicios, pleitos y los costos incidente además, incluyendo costos de defensa, de acuerdo judicial, y de honorarios razonables del abogado, que pueden ser incurridos en, o como resultado de, la muerte o herida personal a cualquier persona, o daños a cualquier característica, propiedad, contaminación de la tierra o efectos ilícitos en esta Facilidad, causado entero o en parte por el cliente, sus empleados, o sus subcontratistas en botar basura en esta Facilidad. En el caso que el Cliente entrega, bota, basura (según lo determinado por Republic) en este Establecimiento basura inaceptable en los reglamentos de este Establecimiento, el Cliente se compromete asumir todos los costos y obligaciones con el retiro y/o la resolución de cualquier dano(s) causado por la entrega de tal basura inaceptable.



NON-HAZARDOUS WASTE MANIFEST

MANIFEST # 11864

GENERATOR INFORMATION

Generator Name: Tronox LLC

Address: P.O. Box 55

City: Henderson County: Clark

State: NV Zip: 89009

Site Location (if different): 560 W. Lake Mead
Henderson, NV 89015 (702) 592-7727

CUSTOMER/BILLING INFORMATION

Billing Name: NGE LLC c/o Northgate Environment Management

Address: 300 Frank Ogawa Plaza, Ste 510

City: Oakland County: Alameda

State: CA Zip: 94612

Table with 5 columns: Republic Services Approval #, Description of Waste, Volume/Weight, Expiration Date, Container Type. Row 1: 38251011244, Soil for disposal, 34.92 ton, 12-31-2011, Tractor with Dump Trailer(s).

*Attach Additional Sheet if necessary

I hereby certify that the above-described materials are non-hazardous wastes as defined by 40 CFR 261 or any applicable state law. Further, that the above named materials are properly classified, described, packaged, marked and labeled, and are in proper condition for transportation according to the applicable regulations of the Department of Transportation.

Susan Crowley (Signature)
Generator/Authorized Agent Name Signature Date Shipped

TRANSPORTER INFORMATION

Transporter Name: Las Vegas Paving

DOT # 191949

Address: 4420 S. Decatur

Truck Number: 190456

Las Vegas, NV 89103

Phone Number: (702) 353-4355

I certify no hazardous waste or other regulated substance was knowingly introduced to the waste while in my custody. The waste transported in this vehicle is the waste identified above, to the best of my knowledge.

Blue (Signature) 10/3/10
Name of Authorized Agent Signature Date Delivered

DISPOSAL SITE INFORMATION

Site Name: Apex Regional Landfill

Phone No. (702) 599-5920

Address: 13550 U.S. Hwy 93 Las Vegas, NV

I hereby acknowledge receipt of the above described materials
Hickson, So Jack (Signature) 005 Oct 10
Name (Print or Type) Signature Date Received

81 Environmental Tech
13550 N Highway 93
Las Vegas, NV 89165

Ticket Type: INBOUND INVOICE

Ticket Number: 1770
Date: 10/05/2010
Time In: 9:40 pm
Time Out: 10:10 pm

Customer: 001011 - NGE, LLC c/o Northgate Environ Mgmt

Vehicle/Container: 192460
Contract: Northgate Env. On Site Soils 3825 11
Comment: 3825 10 11244

Gross Weight: 125,820 LB Manual In
Tare Weight: 53,440 LB Manual Out
Net Weight: 72380 LB
Net Tons: 36.19

BOL: 11865

Origin	Yards	Material	Billing Quantity
Not Applicable	0.00 YD	SW CONTAMINATED SOIL	36.19 TN

Driver:

Daig Honish

Weighmaster:

Sei Derick

HOLDENS

Indemnification. Customer agrees, by signature above, to indemnify, hold harmless, and defend Republic Services, Inc., its subsidiaries, affiliates, employees, officers and directors from and against any and all liabilities, claims, penalties, forfeitures, suits and the costs and expenses incident thereto, including costs of defense, settlement, and reasonable attorney's fees, which may be incurred, as a result of death or injuries to any person, or damage to any property, contamination of or adverse effects on the environment, caused in whole or in part by the Customer, its employees, or subcontractors in disposing waste at this Facility. In the event Customer delivers Unacceptable Waste (as determined by Republic) Customer agrees to assume all expenses and obligations with the removal and/or resolution of any effects caused by the delivery of such Unacceptable Waste.

Indemnización. Cliente acuerda indemnizar, mantener inmune, y defender Republic Services, Inc., sus subsidiarios, compañías, divisiones, empleados, oficiales y directores contra de cualquiera y de todas responsabilidades, demandas, penas, pérdidas, juicios, pleitos y los costos incidente además, incluyendo costos de defensa, de acuerdo judicial, y de honorarios razonables del abogado, que pueden ser incurridos en, o como resultado de, la muerte o herida personal a cualquier persona, o daños a cualquier característica, propiedad, contaminación de la tierra o efectos ilícitos en esta Facilidad, causado entero o en parte por el cliente, sus empleados, o sus subcontratistas en botar basura en esta Facilidad. En el caso que el Cliente entrega, bota, basura (según lo determinado por Republic) en este Establecimiento basura inaceptable en los reglamentos de este Establecimiento, el Cliente se compromete asumir todos los costos y obligaciones con el retiro y/o la resolución de cualquier dano(s) causado por la entrega de tal basura inaceptable.



NON-HAZARDOUS WASTE MANIFEST

MANIFEST # 11865

GENERATOR INFORMATION

Generator Name: Tronox LLC

Address: P.O. Box 55

City: Henderson County: Clark

State: NV Zip: 89009

Site Location (if different): 560 W. Lake Mead

Henderson, NV 89015 (702) 592-7727

CUSTOMER/BILLING INFORMATION

Billing Name: NGE LLC c/o Northgate Environment Management

Address: 300 Frank Ogawa Plaza, Ste 510

City: Oakland County: Alameda

State: CA Zip: 94612

Republic Services Approval #	Description of Waste	Volume/Weight	Expiration Date	Container Type
38251011244	Soil for disposal	36 ¹⁹ / _{ton}	12-31-2011	Tractor with Dump Trailer(s)
	RZ- _____ # _____			

*Attach Additional Sheet if necessary

I hereby certify that the above-described materials are non-hazardous wastes as defined by 40 CFR 261 or any applicable state law. Further, that the above named materials are properly classified, described, packaged, marked and labeled, and are in proper condition for transportation according to the applicable regulations of the Department of Transportation.

Susan Crowley Tom Crowley _____
 Generator/Authorized Agent Name Signature Date Shipped

TRANSPORTER INFORMATION

Transporter Name: Las Vegas Paving

DOT # 191949

Address: 4420 S. Decatur

Truck Number: 2460

Las Vegas, NV 89103

Phone Number: (702) 353-4355

I certify no hazardous waste or other regulated substance was knowingly introduced to the waste while in my custody. The waste transported in this vehicle is the waste identified above, to the best of my knowledge.

Graig Honish Graig Honish 10-5-10
 Name of Authorized Agent Signature Date Delivered

DISPOSAL SITE INFORMATION

Site Name: Apex Regional Landfill

Phone No. (702) 599-5920

Address: 13550 U.S. Hwy 93 Las Vegas, NV

I hereby acknowledge receipt of the above described materials

Holden, Derrick Derrick Holden 05 Oct 10
 Name (Print or Type) Signature Date Received

81 Environmental Tech
13550 N Highway 93
Las Vegas, NV 89165

Ticket Type: INBOUND INVOICE

Ticket Number: 1771
Date: 10/05/2010
Time In: 9:55 pm
Time Out: 10:18 pm

Customer: 001011 - NGE, LLC c/o Northgate Environ Mgmt

Vehicle/Container: 35903A
Contract: Northgate Env. On Site Soils 3825 11
Comment: 3825 10 11244

Gross Weight: 123,960 LB Manual In
Tare Weight: 55,720 LB Manual Out
Net Weight: 68,240 LB
Net Tons: 34.12

BOL: 11866

Origin	Yards	Material	Billing Quantity
Not Applicable	0.00 YD	SW CONTAMINATED SOIL	34.12 TN

Driver:

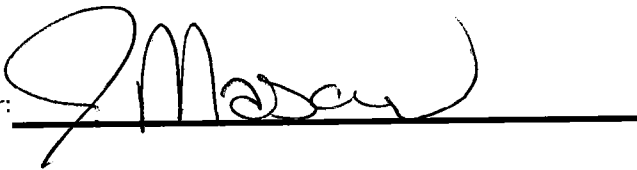

Weighmaster:

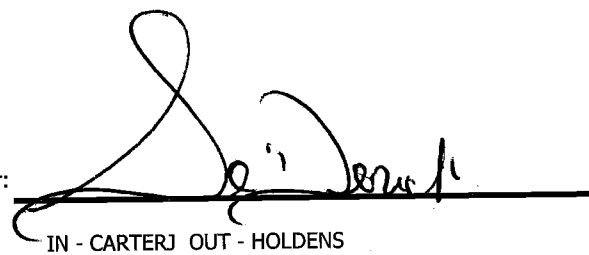

IN - CARTERJ OUT - HOLDENS

Indemnification. Customer agrees, by signature above, to indemnify, hold harmless, and defend Republic Services, Inc., its subsidiaries, affiliates, employees, officers and directors from and against any and all liabilities, claims, penalties, forfeitures, suits and the costs and expenses incident thereto, including costs of defense, settlement, and reasonable attorney's fees, which may be incurred, as a result of death or injuries to any person, or damage to any property, contamination of or adverse effects on the environment, caused in whole or in part by the Customer, its employees, or subcontractors in disposing waste at this Facility. In the event Customer delivers Unacceptable Waste (as determined by Republic) Customer agrees to assume all expenses and obligations with the removal and/or resolution of any effects caused by the delivery of such Unacceptable Waste.

Indemnización. Cliente acuerda indemnizar, mantener inmune, y defender Republic Services, Inc., sus subsidiarios, compañías, divisiones, empleados, oficiales y directores contra de cualquiera y de todas responsabilidades, demandas, penas, pérdidas, juicios, pleitos y los costos incidente además, incluyendo costos de defensa, de acuerdo judicial, y de honorarios razonables del abogado, que pueden ser incurridos en, o como resultado de, la muerte o herida personal a cualquier persona, o daños a cualquier característica, propiedad, contaminación de la tierra o efectos ilícitos en esta Facilidad, causado entero o en parte por el cliente, sus empleados, o sus subcontratistas en botar basura en esta Facilidad. En el caso que el Cliente entrega, bota, basura (según lo determinado por Republic) en este Establecimiento basura inaceptable en los reglamentos de este Establecimiento, el Cliente se compromete asumir todos los costos y obligaciones con el retiro y/o la resolución de cualquier dano(s) causado por la entrega de tal basura inaceptable.



NON-HAZARDOUS WASTE MANIFEST

MANIFEST # 11866

GENERATOR INFORMATION

Generator Name: Tronox LLC
Address: P.O. Box 55
City: Henderson County: Clark
State: NV Zip: 89009
Site Location (if different): 560 W. Lake Mead
Henderson, NV 89015 (702) 592-7727

CUSTOMER/BILLING INFORMATION

Billing Name: NGE LLC c/o Northgate Environment Management
Address: 300 Frank Ogawa Plaza, Ste 510
City: Oakland County: Alameda
State: CA Zip: 94612

Table with 5 columns: Republic Services Approval #, Description of Waste, Volume/Weight, Expiration Date, Container Type. Row 1: 38251011244, Soil for disposal, 34 1/2 ton, 12-31-2011, Tractor with Dump Trailer(s).

*Attach Additional Sheet if necessary

I hereby certify that the above-described materials are non-hazardous wastes as defined by 40 CFR 261 or any applicable state law. Further, that the above named materials are properly classified, described, packaged, marked and labeled, and are in proper condition for transportation according to the applicable regulations of the Department of Transportation.

Susan Crowley (Signature)
Generator/Authorized Agent Name Signature Date Shipped

TRANSPORTER INFORMATION

Transporter Name: Las Vegas Paving DOT # 191949
Address: 4420 S. Decatur Truck Number: 07
Las Vegas, NV 89103 Phone Number: (702) 353-4355

I certify no hazardous waste or other regulated substance was knowingly introduced to the waste while in my custody. The waste transported in this vehicle is the waste identified above, to the best of my knowledge.

Wardio BC (Signature) Jay Wilson (Signature) 10-5-10
Name of Authorized Agent Signature Date Delivered

DISPOSAL SITE INFORMATION

Site Name: Apex Regional Landfill Phone No. (702) 599-5920
Address: 13550 U.S. Hwy 93 Las Vegas, NV

I hereby acknowledge receipt of the above described materials.
Helen Se'Jenich (Signature) Date Received 05 Oct 10
Name (Print or Type) Signature Date Received

81 Environmental Tech
13550 N Highway 93
Las Vegas, NV 89165

Ticket Type: INBOUND INVOICE

Ticket Number: 1772
Date: 10/05/2010
Time In: 9:57 pm
Time Out: 10:18 pm

Customer: 001011 - NGE, LLC c/o Northgate Environ Mgmt

Vehicle/Container: 82418P
Contract: Northgate Env. On Site Soils 3825 11
Comment: 3825 10 11244

Gross Weight: 133,800 LB Manual In
Tare Weight: 60,020 LB Manual Out
Net Weight: 73780 LB
Net Tons: 36.89

BOL: 11868

Origin	Yards	Material	Billing	Quantity
Not Applicable	0.00 YD	SW CONTAMINATED SOIL	36.89	TN

Driver:

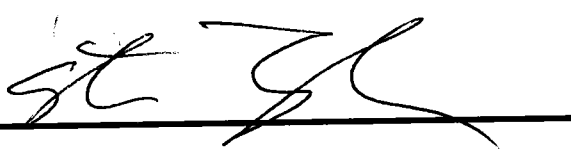

Weighmaster:

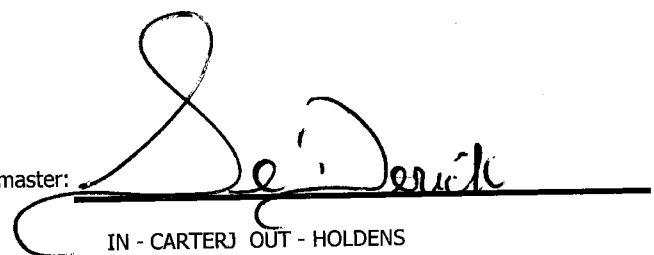

IN - CARTERJ OUT - HOLDENS

Indemnification. Customer agrees, by signature above, to indemnify, hold harmless, and defend Republic Services, Inc., its subsidiaries, affiliates, employees, officers and directors from and against any and all liabilities, claims, penalties, forfeitures, suits and the costs and expenses incident thereto, including costs of defense, settlement, and reasonable attorney's fees, which may be incurred, as a result of death or injuries to any person, or damage to any property, contamination of or adverse effects on the environment, caused in whole or in part by the Customer, its employees, or subcontractors in disposing waste at this Facility. In the event Customer delivers Unacceptable Waste (as determined by Republic) Customer agrees to assume all expenses and obligations with the removal and/or resolution of any effects caused by the delivery of such Unacceptable Waste.

Indemnización. Cliente acuerda indemnizar, mantener inmune, y defender Republic Services, Inc., sus subsidiarios, compañías, divisiones, empleados, oficiales y directores contra de cualquiera y de todas responsabilidades, demandas, penas, pérdidas, juicios, pleitos y los costos incidente además, incluyendo costos de defensa, de acuerdo judicial, y de honorarios razonables del abogado, que pueden ser incurridos en, o como resultado de, la muerte o herida personal a cualquier persona, o daños a cualquier característica, propiedad, contaminación de la tierra o efectos ilícitos en esta Facilidad, causado entero o en parte por el cliente, sus empleados, o sus subcontratistas en botar basura en esta Facilidad. En el caso que el Cliente entrega, bota, basura (según lo determinado por Republic) en este Establecimiento basura inaceptable en los reglamentos de este Establecimiento, el Cliente se compromete asumir todos los costos y obligaciones con el retiro y/o la resolución de cualquier dano(s) causado por la entrega de tal basura inaceptable.



NON-HAZARDOUS WASTE MANIFEST

MANIFEST # 11868

GENERATOR INFORMATION

Generator Name: Tronox LLC
Address: P.O. Box 55
City: Henderson County: Clark
State: NV Zip: 89009
Site Location (if different): 560 W. Lake Mead
Henderson, NV 89015 (702) 592-7727

CUSTOMER/BILLING INFORMATION

Billing Name: NGE LLC c/o Northgate Environment Management
Address: 300 Frank Ogawa Plaza, Ste 510
City: Oakland County: Alameda
State: CA Zip: 94612

Table with 5 columns: Republic Services Approval #, Description of Waste, Volume/Weight, Expiration Date, Container Type. Row 1: 38251011244, Soil for disposal, 36 84/100, 12-31-2011, Tractor with Dump Trailer(s).

*Attach Additional Sheet if necessary

I hereby certify that the above-described materials are non-hazardous wastes as defined by 40 CFR 261 or any applicable state law. Further, that the above named materials are properly classified, described, packaged, marked and labeled, and are in proper condition for transportation according to the applicable regulations of the Department of Transportation.

Susan Crowley (Signature)
Generator/Authorized Agent Name Signature Date Shipped

TRANSPORTER INFORMATION

Transporter Name: Las Vegas Paving DOT # 191949
Address: 4420 S. Decatur Truck Number: 220
Las Vegas, NV 89103 Phone Number: (702) 353-4355

I certify no hazardous waste or other regulated substance was knowingly introduced to the waste while in my custody. The waste transported in this vehicle is the waste identified above, to the best of my knowledge.

STEVE TAYLOR (Signature)
Name of Authorized Agent Signature Date Delivered 10-5-10

DISPOSAL SITE INFORMATION

Site Name: Apex Regional Landfill Phone No. (702) 599-5920
Address: 13550 U.S. Hwy 93 Las Vegas, NV

I hereby acknowledge receipt of the above described materials
Holder So Derek (Signature)
Name (Print of Type) Signature Date Received 05 Oct 10

81 Environmental Tech
13550 N Highway 93
Las Vegas, NV 89165

Ticket Type: INBOUND INVOICE

Ticket Number: 1773
Date: 10/05/2010
Time In: 10:02 pm
Time Out: 10:22 pm

Customer: 001011 - NGE, LLC c/o Northgate Environ Mgmt

Vehicle/Container: 81494P
Contract: Northgate Env. On Site Soils 3825 11
Comment: 3825 10 11244

Gross Weight: 120,560 LB Manual In
Tare Weight: 51,060 LB Manual Out
Net Weight: 69500 LB
Net Tons: 34.75

BOL: 11869

Origin	Yards	Material	Billing	Quantity
Not Applicable	0.00 YD	SW CONTAMINATED SOIL	34.75	TN

Driver: _____



Weighmaster: _____

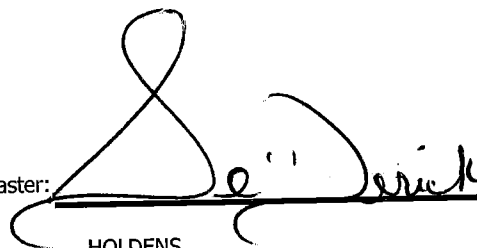

HOLDENS

Indemnification. Customer agrees, by signature above, to indemnify, hold harmless, and defend Republic Services, Inc., its subsidiaries, affiliates, employees, officers and directors from and against any and all liabilities, claims, penalties, forfeitures, suits and the costs and expenses incident thereto, including costs of defense, settlement, and reasonable attorney's fees, which may be incurred, as a result of death or injuries to any person, or damage to any property, contamination of or adverse effects on the environment, caused in whole or in part by the Customer, its employees, or subcontractors in disposing waste at this Facility. In the event Customer delivers Unacceptable Waste (as determined by Republic) Customer agrees to assume all expenses and obligations with the removal and/or resolution of any effects caused by the delivery of such Unacceptable Waste.

Indemnización. Cliente acuerda indemnizar, mantener inmune, y defender Republic Services, Inc., sus subsidiarios, compañías, divisiones, empleados, oficiales y directores contra de cualquiera y de todas responsabilidades, demandas, penas, pérdidas, juicios, pleitos y los costos incidente además, incluyendo costos de defensa, de acuerdo judicial, y de honorarios razonables del abogado, que pueden ser incurridos en, o como resultado de, la muerte o herida personal a cualquier persona, o daños a cualquier característica, propiedad, contaminación de la tierra o efectos ilícitos en esta Facilidad, causado entero o en parte por el cliente, sus empleados, o sus subcontratistas en botar basura en esta Facilidad. En el caso que el Cliente entrega, bota, basura (según lo determinado por Republic) en este Establecimiento basura inaceptable en los reglamentos de este Establecimiento, el Cliente se compromete asumir todos los costos y obligaciones con el retiro y/o la resolución de cualquier dano(s) causado por la entrega de tal basura inaceptable.



NON-HAZARDOUS WASTE MANIFEST

MANIFEST # 11869

GENERATOR INFORMATION

Generator Name: Tronox LLC
Address: P.O. Box 55
City: Henderson County: Clark
State: NV Zip: 89009
Site Location (if different): 560 W. Lake Mead
Henderson, NV 89015 (702) 592-7727

CUSTOMER/BILLING INFORMATION

Billing Name: NGE LLC c/o Northgate Environment Management
Address: 300 Frank Ogawa Plaza, Ste 510
City: Oakland County: Alameda
State: CA Zip: 94612

Table with 5 columns: Republic Services Approval #, Description of Waste, Volume/Weight, Expiration Date, Container Type. Row 1: 38251011244, Soil for disposal, 34 75/100, 12-31-2011, Tractor with Dump Trailer(s)

*Attach Additional Sheet if necessary

I hereby certify that the above-described materials are non-hazardous wastes as defined by 40 CFR 261 or any applicable state law. Further, that the above named materials are properly classified, described, packaged, marked and labeled, and are in proper condition for transportation according to the applicable regulations of the Department of Transportation.

Susan Crowley
Generator/Authorized Agent Name Signature Date Shipped

TRANSPORTER INFORMATION

Transporter Name: Las Vegas Paving DOT # 191949
Address: 4420 S. Decatur Truck Number: 125
Las Vegas, NV 89103 Phone Number: (702) 353-4355

I certify no hazardous waste or other regulated substance was knowingly introduced to the waste while in my custody. The waste transported in this vehicle is the waste identified above, to the best of my knowledge.

Calvin Paguyo Calvin Paguyo 10-05-10
Name of Authorized Agent Signature Date Delivered

DISPOSAL SITE INFORMATION

Site Name: Apex Regional Landfill Phone No. (702) 599-5920
Address: 13550 U.S. Hwy 93 Las Vegas, NV

I hereby acknowledge receipt of the above described materials
Name (Print or Type) Signature Date Received
Holden, Se'Derick Se'Derick Holden 05 Oct 10

81 Environmental Tech
13550 N Highway 93
Las Vegas, NV 89165

Ticket Type: INBOUND INVOICE

Ticket Number: 1774
Date: 10/05/2010
Time In: 10:09 pm
Time Out: 10:30 pm

Customer: 001011 - NGE, LLC c/o Northgate Environ Mgmt

Vehicle/Container: 86053P
Contract: Northgate Env. On Site Soils 3825 11
Comment: 3825 10 11244

Gross Weight: 121,980 LB Manual In
Tare Weight: 54,640 LB Scale Out
Net Weight: 67340 LB
Net Tons: 33.67

BOL: 11870

Origin	Yards	Material	Billing Quantity
Not Applicable	0.00 YD	SW CONTAMINATED SOIL	33.67 TN

Driver: _____

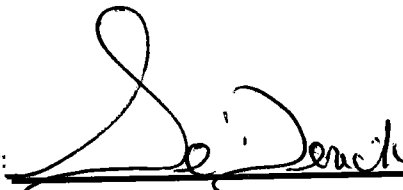

Weighmaster: _____

HOLDENS

Indemnification. Customer agrees, by signature above, to indemnify, hold harmless, and defend Republic Services, Inc., its subsidiaries, affiliates, employees, officers and directors from and against any and all liabilities, claims, penalties, forfeitures, suits and the costs and expenses incident thereto, including costs of defense, settlement, and reasonable attorney's fees, which may be incurred, as a result of death or injuries to any person, or damage to any property, contamination of or adverse effects on the environment, caused in whole or in part by the Customer, its employees, or subcontractors in disposing waste at this Facility. In the event Customer delivers Unacceptable Waste (as determined by Republic) Customer agrees to assume all expenses and obligations with the removal and/or resolution of any effects caused by the delivery of such Unacceptable Waste.

Indemnización. Cliente acuerda indemnizar, mantener inmune, y defender Republic Services, Inc., sus subsidiarios, compañías, divisiones, empleados, oficiales y directores contra de cualquiera y de todas responsabilidades, demandas, penas, pérdidas, juicios, pleitos y los costos incidente además, incluyendo costos de defensa, de acuerdo judicial, y de honorarios razonables del abogado, que pueden ser incurridos en, o como resultado de, la muerte o herida personal a cualquier persona, o daños a cualquier característica, propiedad, contaminación de la tierra o efectos ilícitos en esta Facilidad, causado entero o en parte por el cliente, sus empleados, o sus subcontratistas en botar basura en esta Facilidad. En el caso que el Cliente entrega, bota, basura (según lo determinado por Republic) en este Establecimiento basura inaceptable en los reglamentos de este Establecimiento, el Cliente se compromete asumir todos los costos y obligaciones con el retiro y/o la resolución de cualquier dano(s) causado por la entrega de tal basura inaceptable.



NON-HAZARDOUS WASTE MANIFEST

MANIFEST # 11870

GENERATOR INFORMATION

Generator Name: Tronox LLC

Address: P.O. Box 55

City: Henderson County: Clark

State: NV Zip: 89009

Site Location (if different): 560 W. Lake Mead

Henderson, NV 89015 (702) 592-7727

CUSTOMER/BILLING INFORMATION

Billing Name: NGE LLC c/o Northgate Environment Management

Address: 300 Frank Ogawa Plaza, Ste 510

City: Oakland County: Alameda

State: CA Zip: 94612

Table with 5 columns: Republic Services Approval #, Description of Waste, Volume/Weight, Expiration Date, Container Type. Row 1: 38251011244, Soil for disposal, 33 407/100, 12-31-2011, Tractor with Dump Trailer(s).

*Attach Additional Sheet if necessary

I hereby certify that the above-described materials are non-hazardous wastes as defined by 40 CFR 261 or any applicable state law. Further, that the above named materials are properly classified, described, packaged, marked and labeled, and are in proper condition for transportation according to the applicable regulations of the Department of Transportation.

Susan Crowley (Signature) Generator/Authorized Agent Name Date Shipped

TRANSPORTER INFORMATION

Transporter Name: Las Vegas Paving

DOT # 191949

Address: 4420 S. Decatur

Truck Number: 261

Las Vegas, NV 89103

Phone Number: (702) 353-4355

I certify no hazardous waste or other regulated substance was knowingly introduced to the waste while in my custody. The waste transported in this vehicle is the waste identified above, to the best of my knowledge.

Patrick L. Davis (Signature) Name of Authorized Agent Date Delivered 50710

DISPOSAL SITE INFORMATION

Site Name: Apex Regional Landfill

Phone No. (702) 599-5920

Address: 13550 U.S. Hwy 93 Las Vegas, NV

I hereby acknowledge receipt of the above described materials

Holden, S. (Signature) Name (Print or Type) Date Received 05 Oct 10

81 Environmental Tech
13550 N Highway 93
Las Vegas, NV 89165

Ticket Type: INBOUND INVOICE

Ticket Number: 1775
Date: 10/05/2010
Time In: 10:16 pm
Time Out: 10:37 pm

Customer: 001011 - NGE, LLC c/o Northgate Environ Mgmt

Vehicle/Container: 76810P
Contract: Northgate Env. On Site Soils 3825 11
Comment: 3825 10 11244

Gross Weight: 120,100 LB Manual In
Tare Weight: 54,640 LB Scale Out
Net Weight: 65,460 LB
Net Tons: 32.73

BOL: 11872

Origin	Yards	Material	Billing	Quantity
Not Applicable	0.00 YD	SW CONTAMINATED SOIL	32.73	TN

Driver:

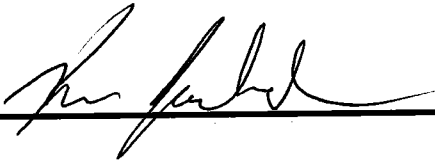

Weighmaster:

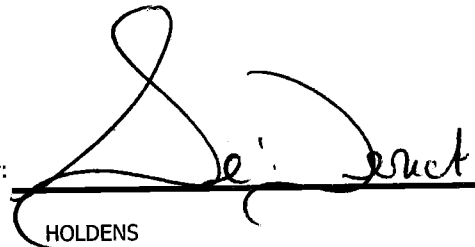

HOLDENS

Indemnification. Customer agrees, by signature above, to indemnify, hold harmless, and defend Republic Services, Inc., its subsidiaries, affiliates, employees, officers and directors from and against any and all liabilities, claims, penalties, forfeitures, suits and the costs and expenses incident thereto, including costs of defense, settlement, and reasonable attorney's fees, which may be incurred, as a result of death or injuries to any person, or damage to any property, contamination of or adverse effects on the environment, caused in whole or in part by the Customer, its employees, or subcontractors in disposing waste at this Facility. In the event Customer delivers Unacceptable Waste (as determined by Republic) Customer agrees to assume all expenses and obligations with the removal and/or resolution of any effects caused by the delivery of such Unacceptable Waste.

Indemnización. Cliente acuerda indemnizar, mantener inmune, y defender Republic Services, Inc., sus subsidiarios, compañías, divisiones, empleados, oficiales y directores contra de cualquiera y de todas responsabilidades, demandas, penas, pérdidas, juicios, pleitos y los costos incidente además, incluyendo costos de defensa, de acuerdo judicial, y de honorarios razonables del abogado, que pueden ser incurridos en, o como resultado de, la muerte o herida personal a cualquier persona, o daños a cualquier característica, propiedad, contaminación de la tierra o efectos ilícitos en esta Facilidad, causado entero o en parte por el cliente, sus empleados, o sus subcontratistas en botar basura en esta Facilidad. En el caso que el Cliente entrega, bota, basura (según lo determinado por Republic) en este Establecimiento basura inaceptable en los reglamentos de este Establecimiento, el Cliente se compromete asumir todos los costos y obligaciones con el retiro y/o la resolución de cualquier dano(s) causado por la entrega de tal basura inaceptable.



NON-HAZARDOUS WASTE MANIFEST

MANIFEST # 11872

GENERATOR INFORMATION

Generator Name: Tronox LLC

Address: P.O. Box 55

City: Henderson County: Clark

State: NV Zip: 89009

Site Location (if different): 560 W. Lake Mead
Henderson, NV 89015 (702) 592-7727

CUSTOMER/BILLING INFORMATION

Billing Name: NGE LLC c/o Northgate Environment Management

Address: 300 Frank Ogawa Plaza, Ste 510

City: Oakland County: Alameda

State: CA Zip: 94612

Table with 5 columns: Republic Services Approval #, Description of Waste, Volume/Weight, Expiration Date, Container Type. Row 1: 38251011244, Soil for disposal, 32 7/8 ton, 12-31-2011, Tractor with Dump Trailer(s).

*Attach Additional Sheet if necessary

I hereby certify that the above-described materials are non-hazardous wastes as defined by 40 CFR 261 or any applicable state law. Further, that the above named materials are properly classified, described, packaged, marked and labeled, and are in proper condition for transportation according to the applicable regulations of the Department of Transportation.

Susan Crowley (Signature)
Generator/Authorized Agent Name Signature Date Shipped

TRANSPORTER INFORMATION

Transporter Name: Las Vegas Paving

DOT # 191949

Address: 4420 S. Decatur

Truck Number: 241

Las Vegas, NV 89103

Phone Number: (702) 353-4355

I certify no hazardous waste or other regulated substance was knowingly introduced to the waste while in my custody. The waste transported in this vehicle is the waste identified above, to the best of my knowledge.

KEVIN JACKSON (Signature)
Name of Authorized Agent Signature Date Delivered 10-5-2010

DISPOSAL SITE INFORMATION

Site Name: Apex Regional Landfill

Phone No. (702) 599-5920

Address: 13550 U.S. Hwy 93 Las Vegas, NV

I hereby acknowledge receipt of the above described materials

Holden, Se' Derick (Signature)
Name (Print or Type) Signature Date Received 05 Oct 10

81 Environmental Tech
13550 N Highway 93
Las Vegas, NV 89165

Ticket Type: INBOUND INVOICE

Ticket Number: 1776
Date: 10/05/2010
Time In: 10:17 pm
Time Out: 10:41 pm

Customer: 001011 - NGE, LLC c/o Northgate Environ Mgmt

Vehicle/Container: 34330A
Contract: Northgate Env. On Site Soils 3825 11
Comment: 3825 10 11244

Gross Weight: 122,520 LB Manual In
Tare Weight: 53,240 LB Manual Out
Net Weight: 69,280 LB
Net Tons: 34.64

BOL: 11871

Origin	Yards	Material	Billing	Quantity
Not Applicable	0.00 YD	SW CONTAMINATED SOIL	34.64	TN

Driver:



Weighmaster:

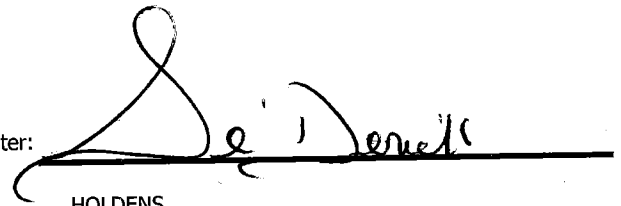

HOLDENS

Indemnification. Customer agrees, by signature above, to indemnify, hold harmless, and defend Republic Services, Inc., its subsidiaries, affiliates, employees, officers and directors from and against any and all liabilities, claims, penalties, forfeitures, suits and the costs and expenses incident thereto, including costs of defense, settlement, and reasonable attorney's fees, which may be incurred, as a result of death or injuries to any person, or damage to any property, contamination of or adverse effects on the environment, caused in whole or in part by the Customer, its employees, or subcontractors in disposing waste at this Facility. In the event Customer delivers Unacceptable Waste (as determined by Republic) Customer agrees to assume all expenses and obligations with the removal and/or resolution of any effects caused by the delivery of such Unacceptable Waste.

Indemnización. Cliente acuerda indemnizar, mantener inmune, y defender Republic Services, Inc., sus subsidiarios, compañías, divisiones, empleados, oficiales y directores contra de cualquiera y de todas responsabilidades, demandas, penas, pérdidas, juicios, pleitos y los costos incidente además, incluyendo costos de defensa, de acuerdo judicial, y de honorarios razonables del abogado, que pueden ser incurridos en, o como resultado de, la muerte o herida personal a cualquier persona, o daños a cualquier característica, propiedad, contaminación de la tierra o efectos ilícitos en esta Facilidad, causado entero o en parte por el cliente, sus empleados, o sus subcontratistas en botar basura en esta Facilidad. En el caso que el Cliente entrega, bota, basura (según lo determinado por Republic) en este Establecimiento basura inaceptable en los reglamentos de este Establecimiento, el Cliente se compromete asumir todos los costos y obligaciones con el retiro y/o la resolución de cualquier dano(s) causado por la entrega de tal basura inaceptable.



NON-HAZARDOUS WASTE MANIFEST

MANIFEST # 11871

GENERATOR INFORMATION

Generator Name: Tronox LLC
Address: P.O. Box 55
City: Henderson County: Clark
State: NV Zip: 89009
Site Location (if different): 560 W. Lake Mead
Henderson, NV 89015 (702) 592-7727

CUSTOMER/BILLING INFORMATION

Billing Name: NGE LLC c/o Northgate Environment Management
Address: 300 Frank Ogawa Plaza, Ste 510
City: Oakland County: Alameda
State: CA Zip: 94612

Table with 5 columns: Republic Services Approval #, Description of Waste, Volume/Weight, Expiration Date, Container Type. Row 1: 38251011244, Soil for disposal, 34 64/100, 12-31-2011, Tractor with Dump Trailer(s). Row 2: RZ- #

*Attach Additional Sheet if necessary

I hereby certify that the above-described materials are non-hazardous wastes as defined by 40 CFR 261 or any applicable state law. Further, that the above named materials are properly classified, described, packaged, marked and labeled, and are in proper condition for transportation according to the applicable regulations of the Department of Transportation.

Susan Crowley (Signature)
Generator/Authorized Agent Name Signature Date Shipped

TRANSPORTER INFORMATION

Transporter Name: Las Vegas Paving DOT # 191949
Address: 4420 S. Decatur Truck Number: 981
Las Vegas, NV 89103 Phone Number: (702) 353-4355

I certify no hazardous waste or other regulated substance was knowingly introduced to the waste while in my custody. The waste transported in this vehicle is the waste identified above, to the best of my knowledge.

Tom Rawling (Signature) Signature Date Delivered 10-5-10
Name of Authorized Agent Signature Date Delivered

DISPOSAL SITE INFORMATION

Site Name: Apex Regional Landfill Phone No. (702) 599-5920
Address: 13550 U.S. Hwy 93 Las Vegas, NV

I hereby acknowledge receipt of the above described materials
Holden, Se Derick (Signature) Date Received 05 Oct 10
Name (Print or Type) Signature Date Received

81 Environmental Tech
13550 N Highway 93
Las Vegas, NV 89165

Ticket Type: INBOUND INVOICE

Ticket Number: 1777
Date: 10/05/2010
Time In: 10:20 pm
Time Out: 10:43 pm

Customer: 001011 - NGE, LLC c/o Northgate Environ Mgmt

Vehicle/Container: 81496P
Contract: Northgate Env. On Site Soils 3825 11
Comment: 3825 10 11244

Gross Weight: 120,780 LB Manual In
Tare Weight: 50,360 LB Manual Out
Net Weight: 70420 LB
Net Tons: 35.21

BOL: 11867

Origin	Yards	Material	Billing Quantity
Not Applicable	0.00 YD	SW CONTAMINATED SOIL	35.21 TN

Driver:

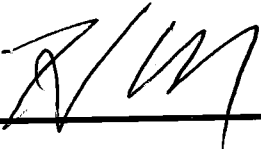

Weighmaster:

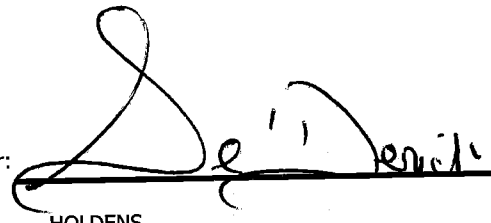

HOLDENS

Indemnification. Customer agrees, by signature above, to indemnify, hold harmless, and defend Republic Services, Inc., its subsidiaries, affiliates, employees, officers and directors from and against any and all liabilities, claims, penalties, forfeitures, suits and the costs and expenses incident thereto, including costs of defense, settlement, and reasonable attorney's fees, which may be incurred, as a result of death or injuries to any person, or damage to any property, contamination of or adverse effects on the environment, caused in whole or in part by the Customer, its employees, or subcontractors in disposing waste at this Facility. In the event Customer delivers Unacceptable Waste (as determined by Republic) Customer agrees to assume all expenses and obligations with the removal and/or resolution of any effects caused by the delivery of such Unacceptable Waste.

Indemnización. Cliente acuerda indemnizar, mantener inmune, y defender Republic Services, Inc., sus subsidiarios, compañías, divisiones, empleados, oficiales y directores contra de cualquiera y de todas responsabilidades, demandas, penas, pérdidas, juicios, pleitos y los costos incidente además, incluyendo costos de defensa, de acuerdo judicial, y de honorarios razonables del abogado, que pueden ser incurridos en, o como resultado de, la muerte o herida personal a cualquier persona, o daños a cualquier característica, propiedad, contaminación de la tierra o efectos ilícitos en esta Facilidad, causado entero o en parte por el cliente, sus empleados, o sus subcontratistas en botar basura en esta Facilidad. En el caso que el Cliente entrega, bota, basura (según lo determinado por Republic) en este Establecimiento basura inaceptable en los reglamentos de este Establecimiento, el Cliente se compromete asumir todos los costos y obligaciones con el retiro y/o la resolución de cualquier dano(s) causado por la entrega de tal basura inaceptable.



NON-HAZARDOUS WASTE MANIFEST

MANIFEST # 11867

GENERATOR INFORMATION

Generator Name: Tronox LLC

Address: P.O. Box 55

City: Henderson County: Clark

State: NV Zip: 89009

Site Location (if different): 560 W. Lake Mead
Henderson, NV 89015 (702) 592-7727

CUSTOMER/BILLING INFORMATION

Billing Name: NGE LLC c/o Northgate Environment Management

Address: 300 Frank Ogawa Plaza, Ste 510

City: Oakland County: Alameda

State: CA Zip: 94612

Table with 5 columns: Republic Services Approval #, Description of Waste, Volume/Weight, Expiration Date, Container Type. Row 1: 38251011244, Soil for disposal, 35 21/ton, 12-31-2011, Tractor with Dump Trailer(s). Row 2: RZ- #

*Attach Additional Sheet if necessary

I hereby certify that the above-described materials are non-hazardous wastes as defined by 40 CFR 261 or any applicable state law. Further, that the above named materials are properly classified, described, packaged, marked and labeled, and are in proper condition for transportation according to the applicable regulations of the Department of Transportation.

Susan Crowley
Generator/Authorized Agent Name Signature Date Shipped

TRANSPORTER INFORMATION

Transporter Name: Las Vegas Paving

DOT # 191949

Address: 4420 S. Decatur

Truck Number: 145

Las Vegas, NV 89103

Phone Number: (702) 353-4355

I certify no hazardous waste or other regulated substance was knowingly introduced to the waste while in my custody. The waste transported in this vehicle is the waste identified above, to the best of my knowledge.

Harry M. Biel
Name of Authorized Agent Signature Date Delivered 10-5-10

DISPOSAL SITE INFORMATION

Site Name: Apex Regional Landfill

Phone No. (702) 599-5920

Address: 13550 U.S. Hwy 93 Las Vegas, NV

I hereby acknowledge receipt of the above described materials

Hislop, S. D.
Name (Print or Type) Signature Date Received 05 Oct 10

81 Environmental Tech
13550 N Highway 93
Las Vegas, NV 89165

Ticket Type: INBOUND INVOICE

Ticket Number: 1778
Date: 10/05/2010
Time In: 10:28 pm
Time Out: 10:54 pm

Customer: 001011 - NGE, LLC c/o Northgate Environ Mgmt

Vehicle/Container: 76811P
Contract: Northgate Env. On Site Soils 3825 11
Comment: 3825 10 11244

Gross Weight: 124,920 LB Manual In
Tare Weight: 52,880 LB Scale Out
Net Weight: 72040 LB
Net Tons: 36.02

BOL: 11874

Origin	Yards	Material	Billing	Quantity
Not Applicable	0.00 YD	SW CONTAMINATED SOIL	36.02	TN

Driver:

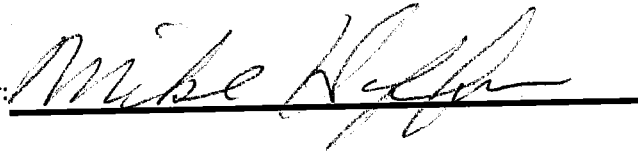

Weighmaster:

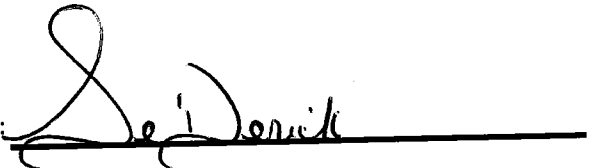
HOLDENS

Indemnification. Customer agrees, by signature above, to indemnify, hold harmless, and defend Republic Services, Inc., its subsidiaries, affiliates, employees, officers and directors from and against any and all liabilities, claims, penalties, forfeitures, suits and the costs and expenses incident thereto, including costs of defense, settlement, and reasonable attorney's fees, which may be incurred, as a result of death or injuries to any person, or damage to any property, contamination of or adverse effects on the environment, caused in whole or in part by the Customer, its employees, or subcontractors in disposing waste at this Facility. In the event Customer delivers Unacceptable Waste (as determined by Republic) Customer agrees to assume all expenses and obligations with the removal and/or resolution of any effects caused by the delivery of such Unacceptable Waste.

Indemnización. Cliente acuerda indemnizar, mantener inmune, y defender Republic Services, Inc., sus subsidiarios, compañías, divisiones, empleados, oficiales y directores contra de cualquiera y de todas responsabilidades, demandas, penas, pérdidas, juicios, pleitos y los costos incidente además, incluyendo costos de defensa, de acuerdo judicial, y de honorarios razonables del abogado, que pueden ser incurridos en, o como resultado de, la muerte o herida personal a cualquier persona, o daños a cualquier característica, propiedad, contaminación de la tierra o efectos ilícitos en esta Facilidad, causado entero o en parte por el cliente, sus empleados, o sus subcontratistas en botar basura en esta Facilidad. En el caso que el Cliente entrega, bota, basura (según lo determinado por Republic) en este Establecimiento basura inaceptable en los reglamentos de este Establecimiento, el Cliente se compromete asumir todos los costos y obligaciones con el retiro y/o la resolución de cualquier dano(s) causado por la entrega de tal basura inaceptable.



NON-HAZARDOUS WASTE MANIFEST

MANIFEST # 11874

GENERATOR INFORMATION

Generator Name: Tronox LLC

Address: P.O. Box 55

City: Henderson County: Clark

State: NV Zip: 89009

Site Location (if different): 560 W. Lake Mead
Henderson, NV 89015 (702) 592-7727

CUSTOMER/BILLING INFORMATION

Billing Name: NGE LLC c/o Northgate Environment Management

Address: 300 Frank Ogawa Plaza, Ste 510

City: Oakland County: Alameda

State: CA Zip: 94612

Table with 5 columns: Republic Services Approval #, Description of Waste, Volume/Weight, Expiration Date, Container Type. Row 1: 38251011244, Soil for disposal, 36.00 ton, 12-31-2011, Tractor with Dump Trailer(s).

*Attach Additional Sheet if necessary

I hereby certify that the above-described materials are non-hazardous wastes as defined by 40 CFR 261 or any applicable state law. Further, that the above named materials are properly classified, described, packaged, marked and labeled, and are in proper condition for transportation according to the applicable regulations of the Department of Transportation.

Susan Crowley (Signature)
Generator/Authorized Agent Name Signature Date Shipped

TRANSPORTER INFORMATION

Transporter Name: Las Vegas Paving

DOT # 191949

Address: 4420 S. Decatur

Truck Number: 242

Las Vegas, NV 89103

Phone Number: (702) 353-4355

I certify no hazardous waste or other regulated substance was knowingly introduced to the waste while in my custody. The waste transported in this vehicle is the waste identified above, to the best of my knowledge.

Mike Heffern (Signature)
Name of Authorized Agent Signature Date Delivered 10-5-10

DISPOSAL SITE INFORMATION

Site Name: Apex Regional Landfill

Phone No. (702) 599-5920

Address: 13550 U.S. Hwy 93 Las Vegas, NV

I hereby acknowledge receipt of the above described materials

Holden, Sr. (Signature)
Name (Print or Type) Signature Date Received 050410

81 Environmental Tech
13550 N Highway 93
Las Vegas, NV 89165

Ticket Type: INBOUND INVOICE

Ticket Number: 1779
Date: 10/05/2010
Time In: 10:30 pm
Time Out: 10:57 pm

Customer: 001011 - NGE, LLC c/o Northgate Environ Mgmt

Vehicle/Container: 44165A
Contract: Northgate Env. On Site Soils 3825 11
Comment: 3825 10 11244

Gross Weight: 124,700 LB Manual In
Tare Weight: 48,900 LB Manual Out
Net Weight: 75,800 LB
Net Tons: 37.90

BOL: 11873

Origin	Yards	Material	Billing Quantity
Not Applicable	0.00 YD	SW CONTAMINATED SOIL	37.90 TN

Driver:



Weighmaster:

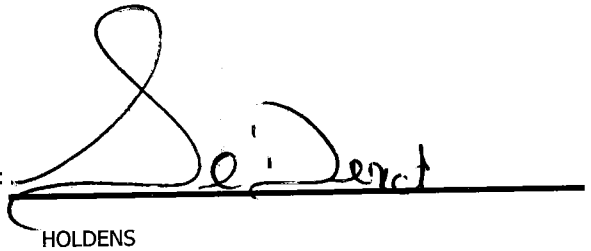

HOLDENS

Indemnification. Customer agrees, by signature above, to indemnify, hold harmless, and defend Republic Services, Inc., its subsidiaries, affiliates, employees, officers and directors from and against any and all liabilities, claims, penalties, forfeitures, suits and the costs and expenses incident thereto, including costs of defense, settlement, and reasonable attorney's fees, which may be incurred, as a result of death or injuries to any person, or damage to any property, contamination of or adverse effects on the environment, caused in whole or in part by the Customer, its employees, or subcontractors in disposing waste at this Facility. In the event Customer delivers Unacceptable Waste (as determined by Republic) Customer agrees to assume all expenses and obligations with the removal and/or resolution of any effects caused by the delivery of such Unacceptable Waste.

Indemnización. Cliente acuerda indemnizar, mantener inmune, y defender Republic Services, Inc., sus subsidiarios, compañías, divisiones, empleados, oficiales y directores contra de cualquiera y de todas responsabilidades, demandas, penas, pérdidas, juicios, pleitos y los costos incidente además, incluyendo costos de defensa, de acuerdo judicial, y de honorarios razonables del abogado, que pueden ser incurridos en, o como resultado de, la muerte o herida personal a cualquier persona, o daños a cualquier característica, propiedad, contaminación de la tierra o efectos ilícitos en esta Facilidad, causado entero o en parte por el cliente, sus empleados, o sus subcontratistas en botar basura en esta Facilidad. En el caso que el Cliente entrega, bota, basura (según lo determinado por Republic) en este Establecimiento basura inaceptable en los reglamentos de este Establecimiento, el Cliente se compromete asumir todos los costos y obligaciones con el retiro y/o la resolución de cualquier dano(s) causado por la entrega de tal basura inaceptable.



NON-HAZARDOUS WASTE MANIFEST

MANIFEST # 11873

GENERATOR INFORMATION

Generator Name: Tronox LLC
Address: P.O. Box 55
City: Henderson County: Clark
State: NV Zip: 89009
Site Location (if different): 560 W. Lake Mead
Henderson, NV 89015 (702) 592-7727

CUSTOMER/BILLING INFORMATION

Billing Name: NGE LLC c/o Northgate Environment Management
Address: 300 Frank Ogawa Plaza, Ste 510
City: Oakland County: Alameda
State: CA Zip: 94612

Table with 5 columns: Republic Services Approval #, Description of Waste, Volume/Weight, Expiration Date, Container Type. Row 1: 38251011244, Soil for disposal, 37 90/100, 12-31-2011, Tractor with Dump Trailer(s).

*Attach Additional Sheet if necessary

I hereby certify that the above-described materials are non-hazardous wastes as defined by 40 CFR 261 or any applicable state law. Further, that the above named materials are properly classified, described, packaged, marked and labeled, and are in proper condition for transportation according to the applicable regulations of the Department of Transportation.

Susan Crowley
Generator/Authorized Agent Name
Signature: [Handwritten Signature]
Date Shipped

TRANSPORTER INFORMATION

Transporter Name: Las Vegas Paving DOT # 191949
Address: 4420 S. Decatur Truck Number: Kool
Las Vegas, NV 89103 Phone Number: (702) 353-4355

I certify no hazardous waste or other regulated substance was knowingly introduced to the waste while in my custody. The waste transported in this vehicle is the waste identified above, to the best of my knowledge.

[Handwritten Signature]
Name of Authorized Agent
Signature: [Handwritten Signature]
Date Delivered: 10-5-10

DISPOSAL SITE INFORMATION

Site Name: Apex Regional Landfill Phone No. (702) 599-5920
Address: 13550 U.S. Hwy 93 Las Vegas, NV

I hereby acknowledge receipt of the above described materials
Name (Print or Type): Holden, Se'Denelle
Signature: [Handwritten Signature]
Date Received: 05 Oct 10

81 Environmental Tech
13550 N Highway 93
Las Vegas, NV 89165

Ticket Type: INBOUND INVOICE

Ticket Number: 1780
Date: 10/05/2010
Time In: 10:38 pm
Time Out: 11:03 pm

Customer: 001011 - NGE, LLC c/o Northgate Environ Mgmt

Vehicle/Container: 44166A
Contract: Northgate Env. On Site Soils 3825 11
Comment: 3825 10 11244

Gross Weight: 130,040 LB Manual In
Tare Weight: 57,400 LB Scale Out
Net Weight: 72640 LB
Net Tons: 36.32

BOL: 11875

Origin	Yards	Material	Billing	Quantity
Not Applicable	0.00 YD	SW CONTAMINATED SOIL	36.32	TN

Driver: _____

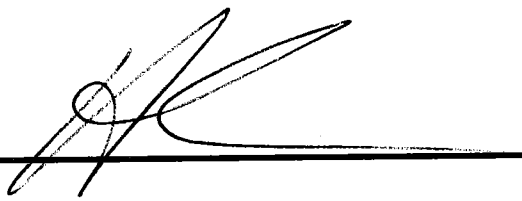

Weighmaster: _____

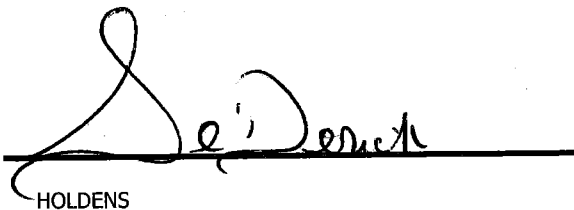

HOLDENS

Indemnification. Customer agrees, by signature above, to indemnify, hold harmless, and defend Republic Services, Inc., its subsidiaries, affiliates, employees, officers and directors from and against any and all liabilities, claims, penalties, forfeitures, suits and the costs and expenses incident thereto, including costs of defense, settlement, and reasonable attorney's fees, which may be incurred, as a result of death or injuries to any person, or damage to any property, contamination of or adverse effects on the environment, caused in whole or in part by the Customer, its employees, or subcontractors in disposing waste at this Facility. In the event Customer delivers Unacceptable Waste (as determined by Republic) Customer agrees to assume all expenses and obligations with the removal and/or resolution of any effects caused by the delivery of such Unacceptable Waste.

Indemnización. Cliente acuerda indemnizar, mantener inmune, y defender Republic Services, Inc., sus subsidiarios, compañías, divisiones, empleados, oficiales y directores contra de cualquiera y de todas responsabilidades, demandas, penas, pérdidas, juicios, pleitos y los costos incidente además, incluyendo costos de defensa, de acuerdo judicial, y de honorarios razonables del abogado, que pueden ser incurridos en, o como resultado de, la muerte o herida personal a cualquier persona, o daños a cualquier característica, propiedad, contaminación de la tierra o efectos ilícitos en esta Facilidad, causado entero o en parte por el cliente, sus empleados, o sus subcontratistas en botar basura en esta Facilidad. En el caso que el Cliente entrega, bota, basura (según lo determinado por Republic) en este Establecimiento basura inaceptable en los reglamentos de este Establecimiento, el Cliente se compromete asumir todos los costos y obligaciones con el retiro y/o la resolución de cualquier dano(s) causado por la entrega de tal basura inaceptable.



NON-HAZARDOUS WASTE MANIFEST

MANIFEST # 11875

GENERATOR INFORMATION

Generator Name: Tronox LLC

Address: P.O. Box 55

City: Henderson County: Clark

State: NV Zip: 89009

Site Location (if different): 560 W. Lake Mead

Henderson, NV 89015 (702) 592-7727

CUSTOMER/BILLING INFORMATION

Billing Name: NGE LLC c/o Northgate Environment Management

Address: 300 Frank Ogawa Plaza, Ste 510

City: Oakland County: Alameda

State: CA Zip: 94612

Republic Services Approval #	Description of Waste	Volume/Weight	Expiration Date	Container Type
38251011244	Soil for disposal	36 ³² / ₁₀₀ ton	12-31-2011	Tractor with Dump Trailer(s)
	RZ- _____ # _____			

*Attach Additional Sheet if necessary

I hereby certify that the above-described materials are non-hazardous wastes as defined by 40 CFR 261 or any applicable state law. Further, that the above named materials are properly classified, described, packaged, marked and labeled, and are in proper condition for transportation according to the applicable regulations of the Department of Transportation.

Susan Crowley (Signature) Generator/Authorized Agent Name Date Shipped

TRANSPORTER INFORMATION

Transporter Name: Las Vegas Paving

DOT # 191949

Address: 4420 S. Decatur

Truck Number: K002

Las Vegas, NV 89103

Phone Number: (702) 353-4355

I certify no hazardous waste or other regulated substance was knowingly introduced to the waste while in my custody. The waste transported in this vehicle is the waste identified above, to the best of my knowledge.

Hugo Restell (Signature) Name of Authorized Agent Date Delivered 10-5-10

DISPOSAL SITE INFORMATION

Site Name: Apex Regional Landfill

Phone No. (702) 599-5920

Address: 13550 U.S. Hwy 93 Las Vegas, NV

I hereby acknowledge receipt of the above described materials Holden, Se' Derek (Signature) Date Received 05 Oct 10

81 Environmental Tech
13550 N Highway 93
Las Vegas, NV 89165

Ticket Type: INBOUND INVOICE

Ticket Number: 1781
Date: 10/05/2010
Time In: 10:39 pm
Time Out: 11:04 pm

Customer: 001011 - NGE, LLC c/o Northgate Environ Mgmt

Vehicle/Container: 86113P
Contract: Northgate Env. On Site Soils 3825 11
Comment: 3825 10 11244

Gross Weight: 136,560 LB Manual In
Tare Weight: 55,560 LB Manual Out
Net Weight: 81000 LB
Net Tons: 40.50

BOL: 11876

Origin	Yards	Material	Billing Quantity
Not Applicable	0.00 YD	SW CONTAMINATED SOIL	40.50 TN

Driver:

J. A. H.

Weighmaster:

[Signature]
HOLDENS

Indemnification. Customer agrees, by signature above, to indemnify, hold harmless, and defend Republic Services, Inc., its subsidiaries, affiliates, employees, officers and directors from and against any and all liabilities, claims, penalties, forfeitures, suits and the costs and expenses incident thereto, including costs of defense, settlement, and reasonable attorney's fees, which may be incurred, as a result of death or injuries to any person, or damage to any property, contamination of or adverse effects on the environment, caused in whole or in part by the Customer, its employees, or subcontractors in disposing waste at this Facility. In the event Customer delivers Unacceptable Waste (as determined by Republic) Customer agrees to assume all expenses and obligations with the removal and/or resolution of any effects caused by the delivery of such Unacceptable Waste.

Indemnización. Cliente acuerda indemnizar, mantener inmune, y defender Republic Services, Inc., sus subsidiarios, compañías, divisiones, empleados, oficiales y directores contra de cualquiera y de todas responsabilidades, demandas, penas, pérdidas, juicios, pleitos y los costos incidente además, incluyendo costos de defensa, de acuerdo judicial, y de honorarios razonables del abogado, que pueden ser incurridos en, o como resultado de, la muerte o herida personal a cualquier persona, o daños a cualquier característica, propiedad, contaminación de la tierra o efectos ilícitos en esta Facilidad, causado entero o en parte por el cliente, sus empleados, o sus subcontratistas en botar basura en esta Facilidad. En el caso que el Cliente entrega, bota, basura (según lo determinado por Republic) en este Establecimiento basura inaceptable en los reglamentos de este Establecimiento, el Cliente se compromete asumir todos los costos y obligaciones con el retiro y/o la resolución de cualquier dano(s) causado por la entrega de tal basura inaceptable.



NON-HAZARDOUS WASTE MANIFEST MANIFEST # 11876

GENERATOR INFORMATION

Generator Name: Tronox LLC
Address: P.O. Box 55
City: Henderson County: Clark
State: NV Zip: 89009
Site Location (if different): 560 W. Lake Mead
Henderson, NV 89015 (702) 592-7727

CUSTOMER/BILLING INFORMATION

Billing Name: NGE LLC c/o Northgate Environment Management
Address: 300 Frank Ogawa Plaza, Ste 510
City: Oakland County: Alameda
State: CA Zip: 94612

Table with 5 columns: Republic Services Approval #, Description of Waste, Volume/Weight, Expiration Date, Container Type. Row 1: 38251011244, Soil for disposal, 4/0 50/ton, 12-31-2011, Tractor with Dump Trailer(s). Row 2: RZ- #

*Attach Additional Sheet if necessary

I hereby certify that the above-described materials are non-hazardous wastes as defined by 40 CFR 261 or any applicable state law. Further, that the above named materials are properly classified, described, packaged, marked and labeled, and are in proper condition for transportation according to the applicable regulations of the Department of Transportation.

Susan Crowley
Generator/Authorized Agent Name Signature Date Shipped

TRANSPORTER INFORMATION

Transporter Name: Las Vegas Paving DOT # 191949
Address: 4420 S. Decatur Truck Number: K001917
Las Vegas, NV 89103 Phone Number: (702) 353-4355

I certify no hazardous waste or other regulated substance was knowingly introduced to the waste while in my custody. The waste transported in this vehicle is the waste identified above, to the best of my knowledge.

ALBERTO
Name of Authorized Agent Signature Date Delivered Oct 5, 2010

DISPOSAL SITE INFORMATION

Site Name: Apex Regional Landfill Phone No. (702) 599-5920
Address: 13550 U.S. Hwy 93 Las Vegas, NV

I hereby acknowledge receipt of the above described materials
Name (Print or Type) Signature Date Received 05 Oct 10

81 Environmental Tech
13550 N Highway 93
Las Vegas, NV 89165

Ticket Type: INBOUND INVOICE

Ticket Number: 1782
Date: 10/05/2010
Time In: 10:43 pm
Time Out: 11:07 pm

Customer: 001011 - NGE, LLC c/o Northgate Environ Mgmt

Vehicle/Container: 68263P
Contract: Northgate Env. On Site Soils 3825 11
Comment: 3825 10 11244

Gross Weight: 126,560 LB Manual In
Tare Weight: 54,340 LB Scale Out
Net Weight: 72220 LB
Net Tons: 36.11

BOL: 11877

Origin	Yards	Material	Billing	Quantity
Not Applicable	0.00 YD	SW CONTAMINATED SOIL	36.11	TN

Driver: _____

Weighmaster: _____

HOLDENS

Indemnification. Customer agrees, by signature above, to indemnify, hold harmless, and defend Republic Services, Inc., its subsidiaries, affiliates, employees, officers and directors from and against any and all liabilities, claims, penalties, forfeitures, suits and the costs and expenses incident thereto, including costs of defense, settlement, and reasonable attorney's fees, which may be incurred, as a result of death or injuries to any person, or damage to any property, contamination of or adverse effects on the environment, caused in whole or in part by the Customer, its employees, or subcontractors in disposing waste at this Facility. In the event Customer delivers Unacceptable Waste (as determined by Republic) Customer agrees to assume all expenses and obligations with the removal and/or resolution of any effects caused by the delivery of such Unacceptable Waste.

Indemnización. Cliente acuerda indemnizar, mantener inmune, y defender Republic Services, Inc., sus subsidiarios, compañías, divisiones, empleados, oficiales y directores contra de cualquiera y de todas responsabilidades, demandas, penas, pérdidas, juicios, pleitos y los costos incidente además, incluyendo costos de defensa, de acuerdo judicial, y de honorarios razonables del abogado, que pueden ser incurridos en, o como resultado de, la muerte o herida personal a cualquier persona, o daños a cualquier característica, propiedad, contaminación de la tierra o efectos ilícitos en esta Facilidad. En el caso que el Cliente entrega, bota, basura (según lo determinado por Republic) en este Establecimiento basura inaceptable en los reglamentos de este Establecimiento, el Cliente se compromete asumir todos los costos y obligaciones con el retiro y/o la resolución de cualquier dano(s) causado por la entrega de tal basura inaceptable.



NON-HAZARDOUS WASTE MANIFEST

MANIFEST # 11877

GENERATOR INFORMATION

Generator Name: Tronox LLC

Address: P.O. Box 55

City: Henderson County: Clark

State: NV Zip: 89009

Site Location (if different): 560 W. Lake Mead
Henderson, NV 89015 (702) 592-7727

CUSTOMER/BILLING INFORMATION

Billing Name: NGE LLC c/o Northgate Environment Management

Address: 300 Frank Ogawa Plaza, Ste 510

City: Oakland County: Alameda

State: CA Zip: 94612

Table with 5 columns: Republic Services Approval #, Description of Waste, Volume/Weight, Expiration Date, Container Type. Row 1: 38251011244, Soil for disposal, 36 1/2 ton, 12-31-2011, Tractor with Dump Trailer(s).

*Attach Additional Sheet if necessary

I hereby certify that the above-described materials are non-hazardous wastes as defined by 40 CFR 261 or any applicable state law. Further, that the above named materials are properly classified, described, packaged, marked and labeled, and are in proper condition for transportation according to the applicable regulations of the Department of Transportation.

Susan Crowley (Signature)
Generator/Authorized Agent Name Signature Date Shipped

TRANSPORTER INFORMATION

Transporter Name: Las Vegas Paving

DOT # 191949

Address: 4420 S. Decatur

Truck Number: 2711

Las Vegas, NV 89103

Phone Number: (702) 353-4355

I certify no hazardous waste or other regulated substance was knowingly introduced to the waste while in my custody. The waste transported in this vehicle is the waste identified above, to the best of my knowledge.

STEVE NAYES (Signature)
Name of Authorized Agent Signature Date Delivered 10-5-10

DISPOSAL SITE INFORMATION

Site Name: Apex Regional Landfill

Phone No. (702) 599-5920

Address: 13550 U.S. Hwy 93 Las Vegas, NV

I hereby acknowledge receipt of the above described materials

Hobden Se Derick (Signature)
Name (Print or Type) Signature Date Received 05 Oct 10

81 Environmental Tech
13550 N Highway 93
Las Vegas, NV 89165

Ticket Type: INBOUND INVOICE

Ticket Number: 1783
Date: 10/05/2010
Time In: 10:47 pm
Time Out: 11:12 pm

Customer: 001011 - NGE, LLC c/o Northgate Environ Mgmt

Vehicle/Container: 81460P
Contract: Northgate Env. On Site Soils 3825 11
Comment: 3825 10 11244

Gross Weight: 126,660 LB Manual In
Tare Weight: 52,700 LB Scale Out
Net Weight: 73960 LB
Net Tons: 36.98

BOL: 11878

Origin	Yards	Material	Billing Quantity
Not Applicable	0.00 YD	SW CONTAMINATED SOIL	36.98 TN

Driver: _____

Weighmaster: _____

HOLDENS

Indemnification. Customer agrees, by signature above, to indemnify, hold harmless, and defend Republic Services, Inc., its subsidiaries, affiliates, employees, officers and directors from and against any and all liabilities, claims, penalties, forfeitures, suits and the costs and expenses incident thereto, including costs of defense, settlement, and reasonable attorney's fees, which may be incurred, as a result of death or injuries to any person, or damage to any property, contamination of or adverse effects on the environment, caused in whole or in part by the Customer, its employees, or subcontractors in disposing waste at this Facility. In the event Customer delivers Unacceptable Waste (as determined by Republic) Customer agrees to assume all expenses and obligations with the removal and/or resolution of any effects caused by the delivery of such Unacceptable Waste.

Indemnización. Cliente acuerda indemnizar, mantener inmune, y defender Republic Services, Inc., sus subsidiarios, compañías, divisiones, empleados, oficiales y directores contra de cualquiera y de todas responsabilidades, demandas, penas, pérdidas, juicios, pleitos y los costos incidente además, incluyendo costos de defensa, de acuerdo judicial, y de honorarios razonables del abogado, que pueden ser incurridos en, o como resultado de, la muerte o herida personal a cualquier persona, o daños a cualquier característica, propiedad, contaminación de la tierra o efectos ilícitos en esta Facilidad, causado entero o en parte por el cliente, sus empleados, o sus subcontratistas en botar basura en esta Facilidad. En el caso que el Cliente entrega, bota, basura (según lo determinado por Republic) en este Establecimiento basura inaceptable en los reglamentos de este Establecimiento, el Cliente se compromete asumir todos los costos y obligaciones con el retiro y/o la resolución de cualquier dano(s) causado por la entrega de tal basura inaceptable.



NON-HAZARDOUS WASTE MANIFEST

MANIFEST # 11878

GENERATOR INFORMATION

Generator Name: Tronox LLC
Address: P.O. Box 55
City: Henderson County: Clark
State: NV Zip: 89009
Site Location (if different): 560 W. Lake Mead
Henderson, NV 89015 (702) 592-7727

CUSTOMER/BILLING INFORMATION

Billing Name: NGE LLC c/o Northgate Environment Management
Address: 300 Frank Ogawa Plaza, Ste 510
City: Oakland County: Alameda
State: CA Zip: 94612

Table with 5 columns: Republic Services Approval #, Description of Waste, Volume/Weight, Expiration Date, Container Type. Row 1: 38251011244, Soil for disposal, 36 tons, 12-31-2011, Tractor with Dump Trailer(s).

*Attach Additional Sheet if necessary

I hereby certify that the above-described materials are non-hazardous wastes as defined by 40 CFR 261 or any applicable state law. Further, that the above named materials are properly classified, described, packaged, marked and labeled, and are in proper condition for transportation according to the applicable regulations of the Department of Transportation.

Susan Crowley (Signature)
Generator/Authorized Agent Name Signature Date Shipped

TRANSPORTER INFORMATION

Transporter Name: Las Vegas Paving DOT # 191949
Address: 4420 S. Decatur Truck Number: 27
Las Vegas, NV 89103 Phone Number: (702) 353-4355

I certify no hazardous waste or other regulated substance was knowingly introduced to the waste while in my custody. The waste transported in this vehicle is the waste identified above, to the best of my knowledge.

Daniel Cardenas (Signature)
Name of Authorized Agent Signature Date Delivered 10-5-2010

DISPOSAL SITE INFORMATION

Site Name: Apex Regional Landfill Phone No. (702) 599-5920
Address: 13550 U.S. Hwy 93 Las Vegas, NV

I hereby acknowledge receipt of the above described materials
Name (Print or Type) Signature Date Received 05 Oct 10

81 Environmental Tech
13550 N Highway 93
Las Vegas, NV 89165

Ticket Type: INBOUND INVOICE

Ticket Number: 1784
Date: 10/05/2010
Time In: 11:10 pm
Time Out: 11:30 pm

Customer: 001011 - NGE, LLC c/o Northgate Environ Mgmt

Vehicle/Container: 44564A
Contract: Northgate Env. On Site Soils 3825 11
Comment: K003

Gross Weight: 123,300 LB Manual In
Tare Weight: 49,360 LB Manual Out
Net Weight: 73940 LB
Net Tons: 36.97

BOL: 11879

Origin	Yards	Material	Billing	Quantity
Not Applicable	0.00 YD	SW CONTAMINATED SOIL	36.97	TN

Driver:

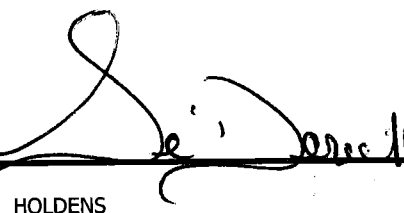

Weighmaster:

HOLDENS

Indemnification. Customer agrees, by signature above, to indemnify, hold harmless, and defend Republic Services, Inc., its subsidiaries, affiliates, employees, officers and directors from and against any and all liabilities, claims, penalties, forfeitures, suits and the costs and expenses incident thereto, including costs of defense, settlement, and reasonable attorney's fees, which may be incurred, as a result of death or injuries to any person, or damage to any property, contamination of or adverse effects on the environment, caused in whole or in part by the Customer, its employees, or subcontractors in disposing waste at this Facility. In the event Customer delivers Unacceptable Waste (as determined by Republic) Customer agrees to assume all expenses and obligations with the removal and/or resolution of any effects caused by the delivery of such Unacceptable Waste.

Indemnización. Cliente acuerda indemnizar, mantener inmune, y defender Republic Services, Inc., sus subsidiarios, compañías, divisiones, empleados, oficiales y directores contra de cualquiera y de todas responsabilidades, demandas, penas, pérdidas, juicios, pleitos y los costos incidente además, incluyendo costos de defensa, de acuerdo judicial, y de honorarios razonables del abogado, que pueden ser incurridos en, o como resultado de, la muerte o herida personal a cualquier persona, o daños a cualquier característica, propiedad, contaminación de la tierra o efectos ilícitos en esta Facilidad, causado entero o en parte por el cliente, sus empleados, o sus subcontratistas en botar basura en esta Facilidad. En el caso que el Cliente entrega, bota, basura (según lo determinado por Republic) en este Establecimiento basura inaceptable en los reglamentos de este Establecimiento, el Cliente se compromete asumir todos los costos y obligaciones con el retiro y/o la resolución de cualquier dano(s) causado por la entrega de tal basura inaceptable.



NON-HAZARDOUS WASTE MANIFEST

MANIFEST # 11879

GENERATOR INFORMATION

Generator Name: Tronox LLCAddress: P.O. Box 55City: Henderson County: ClarkState: NV Zip: 89009Site Location (if different): 560 W. Lake Mead
Henderson, NV 89015 (702) 592-7727

CUSTOMER/BILLING INFORMATION

Billing Name: NGE LLC c/o Northgate Environment ManagementAddress: 300 Frank Ogawa Plaza, Ste 510City: Oakland County: AlamedaState: CA Zip: 94612

Republic Services Approval #	Description of Waste	Volume/Weight	Expiration Date	Container Type
38251011244	Soil for disposal	36 ⁹² / ₁₀₀	12-31-2011	Tractor with Dump Trailer(s)
	RZ- _____ # _____			

*Attach Additional Sheet if necessary

I hereby certify that the above-described materials are non-hazardous wastes as defined by 40 CFR 261 or any applicable state law. Further, that the above named materials are properly classified, described, packaged, marked and labeled, and are in proper condition for transportation according to the applicable regulations of the Department of Transportation.

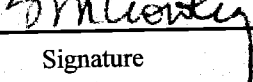
Susan Crowley 
 Generator/Authorized Agent Name Signature Date Shipped

TRANSPORTER INFORMATION

Transporter Name: Las Vegas PavingDOT # 191949Address: 4420 S. DecaturTruck Number: 1003Las Vegas, NV 89103Phone Number: (702) 353-4355

I certify no hazardous waste or other regulated substance was knowingly introduced to the waste while in my custody. The waste transported in this vehicle is the waste identified above, to the best of my knowledge.

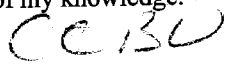
CEBU 
 Name of Authorized Agent Signature Date Delivered 10/05/10

DISPOSAL SITE INFORMATION

Site Name: Apex Regional LandfillPhone No. (702) 599-5920Address: 13550 U.S. Hwy 93 Las Vegas, NV

I hereby acknowledge receipt of the above described materials
Holden Se Senack 
 Name (Print or Type) Signature Date Received 05 Oct 10

81 Environmental Tech
13550 N Highway 93
Las Vegas, NV 89165

Ticket Type: INBOUND INVOICE

Ticket Number: 1785
Date: 10/05/2010
Time In: 11:12 pm
Time Out: 11:37 pm

Customer: 001011 - NGE, LLC c/o Northgate Environ Mgmt

Vehicle/Container: 85887P
Contract: Northgate Env. On Site Soils 3825 11
Comment: 3825 10 11244

Gross Weight: 125,100 LB Manual In
Tare Weight: 50,500 LB Scale Out
Net Weight: 74600 LB
Net Tons: 37.30

BOL: 11880

Origin	Yards	Material	Billing	Quantity
Not Applicable	0.00 YD	SW CONTAMINATED SOIL	37.30	TN

Driver:

Miguel Ramos

Weighmaster:

Sei Desch
HOLDENS

Indemnification. Customer agrees, by signature above, to indemnify, hold harmless, and defend Republic Services, Inc., its subsidiaries, affiliates, employees, officers and directors from and against any and all liabilities, claims, penalties, forfeitures, suits and the costs and expenses incident thereto, including costs of defense, settlement, and reasonable attorney's fees, which may be incurred, as a result of death or injuries to any person, or damage to any property, contamination of or adverse effects on the environment, caused in whole or in part by the Customer, its employees, or subcontractors in disposing waste at this Facility. In the event Customer delivers Unacceptable Waste (as determined by Republic) Customer agrees to assume all expenses and obligations with the removal and/or resolution of any effects caused by the delivery of such Unacceptable Waste.

Indemnización. Cliente acuerda indemnizar, mantener inmune, y defender Republic Services, Inc., sus subsidiarios, compañías, divisiones, empleados, oficiales y directores contra de cualquiera y de todas responsabilidades, demandas, penas, pérdidas, juicios, pleitos y los costos incidente además, incluyendo costos de defensa, de acuerdo judicial, y de honorarios razonables del abogado, que pueden ser incurridos en, o como resultado de, la muerte o herida personal a cualquier persona, o daños a cualquier característica, propiedad, contaminación de la tierra o efectos ilícitos en esta Facilidad, causado entero o en parte por el cliente, sus empleados, o sus subcontratistas en botar basura en esta Facilidad. En el caso que el Cliente entrega, bota, basura (según lo determinado por Republic) en este Establecimiento basura inaceptable en los reglamentos de este Establecimiento, el Cliente se compromete asumir todos los costos y obligaciones con el retiro y/o la resolución de cualquier dano(s) causado por la entrega de tal basura inaceptable.



NON-HAZARDOUS WASTE MANIFEST

MANIFEST # 11880

GENERATOR INFORMATION

Generator Name: Tronox LLC

Address: P.O. Box 55

City: Henderson County: Clark

State: NV Zip: 89009

Site Location (if different): 560 W. Lake Mead

Henderson, NV 89015 (702) 592-7727

CUSTOMER/BILLING INFORMATION

Billing Name: NGE LLC c/o Northgate Environment Management

Address: 300 Frank Ogawa Plaza, Ste 510

City: Oakland County: Alameda

State: CA Zip: 94612

Republic Services Approval #	Description of Waste	Volume/Weight	Expiration Date	Container Type
38251011244	Soil for disposal	37 ³⁰ / ₁₀₀ Ton	12-31-2011	Tractor with Dump Trailer(s)
	RZ- _____ # _____			

*Attach Additional Sheet if necessary

I hereby certify that the above-described materials are non-hazardous wastes as defined by 40 CFR 261 or any applicable state law. Further, that the above named materials are properly classified, described, packaged, marked and labeled, and are in proper condition for transportation according to the applicable regulations of the Department of Transportation.

Susan Crowley (Signature) Date Shipped

TRANSPORTER INFORMATION

Transporter Name: Las Vegas Paving

DOT # 191949

Address: 4420 S. Decatur

Truck Number: 201

Las Vegas, NV 89103

Phone Number: (702) 353-4355

I certify no hazardous waste or other regulated substance was knowingly introduced to the waste while in my custody. The waste transported in this vehicle is the waste identified above, to the best of my knowledge.

M. Guel (Signature) Date Delivered: 10-5-2010

DISPOSAL SITE INFORMATION

Site Name: Apex Regional Landfill

Phone No. (702) 599-5920

Address: 13550 U.S. Hwy 93 Las Vegas, NV

I hereby acknowledge receipt of the above described materials.

Holden, Ser. Derick (Signature) Date Received: 05 Oct 10

81 Environmental Tech
13550 N Highway 93
Las Vegas, NV 89165

Ticket Type: INBOUND INVOICE

Ticket Number: 1786
Date: 10/05/2010
Time In: 11:36 pm
Time Out: 12:06 am

Customer: 001011 - NGE, LLC c/o Northgate Environ Mgmt

Vehicle/Container: 192457
Contract: Northgate Env. On Site Soils 3825 11
Comment: 3825 10 11244

Gross Weight: 124,260 LB Manual In
Tare Weight: 53,480 LB Manual Out
Net Weight: 70,780 LB
Net Tons: 35.39

BOL: 11881

Origin	Yards	Material	Billing Quantity
Not Applicable	0.00 YD	SW CONTAMINATED SOIL	35.39 TN

Driver: 

Weighmaster: 

HOLDENS

Indemnification. Customer agrees, by signature above, to indemnify, hold harmless, and defend Republic Services, Inc., its subsidiaries, affiliates, employees, officers and directors from and against any and all liabilities, claims, penalties, forfeitures, suits and the costs and expenses incident thereto, including costs of defense, settlement, and reasonable attorney's fees, which may be incurred, as a result of death or injuries to any person, or damage to any property, contamination of or adverse effects on the environment, caused in whole or in part by the Customer, its employees, or subcontractors in disposing waste at this Facility. In the event Customer delivers Unacceptable Waste (as determined by Republic) Customer agrees to assume all expenses and obligations with the removal and/or resolution of any effects caused by the delivery of such Unacceptable Waste.

Indemnización. Cliente acuerda indemnizar, mantener inmune, y defender Republic Services, Inc., sus subsidiarios, compañías, divisiones, empleados, oficiales y directores contra de cualquiera y de todas responsabilidades, demandas, penas, pérdidas, juicios, pleitos y los costos incidente además, incluyendo costos de defensa, de acuerdo judicial, y de honorarios razonables del abogado, que pueden ser incurridos en, o como resultado de, la muerte o herida personal a cualquier persona, o daños a cualquier característica, propiedad, contaminación de la tierra o efectos ilícitos en esta Facilidad, causado entero o en parte por el cliente, sus empleados, o sus subcontratistas en botar basura en esta Facilidad. En el caso que el Cliente entrega, bota, basura (según lo determinado por Republic) en este Establecimiento basura inaceptable en los reglamentos de este Establecimiento, el Cliente se compromete asumir todos los costos y obligaciones con el retiro y/o la resolución de cualquier dano(s) causado por la entrega de tal basura inaceptable.



NON-HAZARDOUS WASTE MANIFEST

MANIFEST # 11881

GENERATOR INFORMATION

Generator Name: Tronox LLC

Address: P.O. Box 55

City: Henderson County: Clark

State: NV Zip: 89009

Site Location (if different): 560 W. Lake Mead

Henderson, NV 89015 (702) 592-7727

CUSTOMER/BILLING INFORMATION

Billing Name: NGE LLC c/o Northgate Environment Management

Address: 300 Frank Ogawa Plaza, Ste 510

City: Oakland County: Alameda

State: CA Zip: 94612

Republic Services Approval #	Description of Waste	Volume/Weight	Expiration Date	Container Type
38251011244	Soil for disposal	35 ³⁴ / ₁₀₀	12-31-2011	Tractor with Dump Trailer(s)
	RZ- #			

*Attach Additional Sheet if necessary

I hereby certify that the above-described materials are non-hazardous wastes as defined by 40 CFR 261 or any applicable state law. Further, that the above named materials are properly classified, described, packaged, marked and labeled, and are in proper condition for transportation according to the applicable regulations of the Department of Transportation.

Susan Crowley Generator/Authorized Agent Name Signature Date Shipped

TRANSPORTER INFORMATION

Transporter Name: Las Vegas Paving

DOT # 191949

Address: 4420 S. Decatur

Truck Number: 192457

Las Vegas, NV 89103

Phone Number: (702) 353-4355

I certify no hazardous waste or other regulated substance was knowingly introduced to the waste while in my custody. The waste transported in this vehicle is the waste identified above, to the best of my knowledge.

Brian Brinkerhoff Name of Authorized Agent Signature Date Delivered 10-5-10

DISPOSAL SITE INFORMATION

Site Name: Apex Regional Landfill

Phone No. (702) 599-5920

Address: 13550 U.S. Hwy 93 Las Vegas, NV

I hereby acknowledge receipt of the above described materials Holden, Se... Name (Print or Type) Signature Date Received 05 Oct 10

81 Environmental Tech
13550 N Highway 93
Las Vegas, NV 89165

Ticket Type: INBOUND INVOICE

Ticket Number: 1787
Date: 10/05/2010
Time In: 11:43 pm
Time Out: 12:07 am

Customer: 001011 - NGE, LLC c/o Northgate Environ Mgmt

Vehicle/Container: 192456
Contract: Northgate Env. On Site Soils 3825 11
Comment: 3825 10 11244

Gross Weight: 125,400 LB Manual In
Tare Weight: 53,460 LB Scale Out
Net Weight: 71940 LB
Net Tons: 35.97

BOL: 11882

Origin	Yards	Material	Billing Quantity
Not Applicable	0.00 YD	SW CONTAMINATED SOIL	35.97 TN

Driver: 

Weighmaster: 

HOLDENS

Indemnification. Customer agrees, by signature above, to indemnify, hold harmless, and defend Republic Services, Inc., its subsidiaries, affiliates, employees, officers and directors from and against any and all liabilities, claims, penalties, forfeitures, suits and the costs and expenses incident thereto, including costs of defense, settlement, and reasonable attorney's fees, which may be incurred, as a result of death or injuries to any person, or damage to any property, contamination of or adverse effects on the environment, caused in whole or in part by the Customer, its employees, or subcontractors in disposing waste at this Facility. In the event Customer delivers Unacceptable Waste (as determined by Republic) Customer agrees to assume all expenses and obligations with the removal and/or resolution of any effects caused by the delivery of such Unacceptable Waste.

Indemnización. Cliente acuerda indemnizar, mantener inmune, y defender Republic Services, Inc., sus subsidiarios, compañías, divisiones, empleados, oficiales y directores contra de cualquiera y de todas responsabilidades, demandas, penas, pérdidas, juicios, pleitos y los costos incidente además, incluyendo costos de defensa, de acuerdo judicial, y de honorarios razonables del abogado, que pueden ser incurridos en, o como resultado de, la muerte o herida personal a cualquier persona, o daños a cualquier característica, propiedad, contaminación de la tierra o efectos ilícitos en esta Facilidad, causado entero o en parte por el cliente, sus empleados, o sus subcontratistas en botar basura en esta Facilidad. En el caso que el Cliente entrega, bota, basura (según lo determinado por Republic) en este Establecimiento basura inaceptable en los reglamentos de este Establecimiento, el Cliente se compromete asumir todos los costos y obligaciones con el retiro y/o la resolución de cualquier dano(s) causado por la entrega de tal basura inaceptable.



NON-HAZARDOUS WASTE MANIFEST

MANIFEST # 11882

GENERATOR INFORMATION

Generator Name: Tronox LLC
Address: P.O. Box 55
City: Henderson County: Clark
State: NV Zip: 89009
Site Location (if different): 560 W. Lake Mead
Henderson, NV 89015 (702) 592-7727

CUSTOMER/BILLING INFORMATION

Billing Name: NGE LLC c/o Northgate Environment Management
Address: 300 Frank Ogawa Plaza, Ste 510
City: Oakland County: Alameda
State: CA Zip: 94612

Table with 5 columns: Republic Services Approval #, Description of Waste, Volume/Weight, Expiration Date, Container Type. Row 1: 38251011244, Soil for disposal, 35 97/100, 12-31-2011, Tractor with Dump Trailer(s).

*Attach Additional Sheet if necessary

I hereby certify that the above-described materials are non-hazardous wastes as defined by 40 CFR 261 or any applicable state law. Further, that the above named materials are properly classified, described, packaged, marked and labeled, and are in proper condition for transportation according to the applicable regulations of the Department of Transportation.

Susan Crowley (Generator/Authorized Agent Name), Tom Crowley (Signature), Date Shipped

TRANSPORTER INFORMATION

Transporter Name: Las Vegas Paving DOT # 191949
Address: 4420 S. Decatur Truck Number: 195456
Las Vegas, NV 89103 Phone Number: (702) 353-4355

I certify no hazardous waste or other regulated substance was knowingly introduced to the waste while in my custody. The waste transported in this vehicle is the waste identified above, to the best of my knowledge.

Name of Authorized Agent, Signature, Date Delivered (10/5/10)

DISPOSAL SITE INFORMATION

Site Name: Apex Regional Landfill Phone No. (702) 599-5920
Address: 13550 U.S. Hwy 93 Las Vegas, NV

I hereby acknowledge receipt of the above described materials
Name (Print or Type): Holden, So Jan c ll Signature: Date Received: 05 Oct 10

81 Environmental Tech
13550 N Highway 93
Las Vegas, NV 89165

Ticket Type: INBOUND INVOICE

Ticket Number: 1788
Date: 10/05/2010
Time In: 11:46 pm
Time Out: 12:11 am

Customer: 001011 - NGE, LLC c/o Northgate Environ Mgmt

Vehicle/Container: 192460
Contract: Northgate Env. On Site Soils 3825 11
Comment: 3825 10 11244

Gross Weight: 128,200 LB Manual In
Tare Weight: 53,320 LB Manual Out
Net Weight: 74880 LB
Net Tons: 37.44

BOL: 11883

Origin	Yards	Material	Billing	Quantity
Not Applicable	0.00 YD	SW CONTAMINATED SOIL	37.44	TN

Driver:

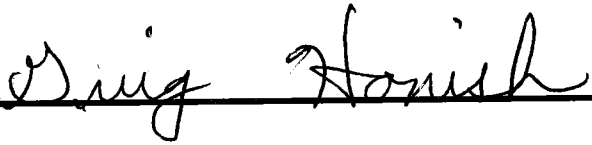

Weighmaster:

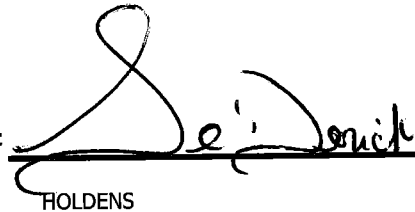
HOLDENS

Indemnification. Customer agrees, by signature above, to indemnify, hold harmless, and defend Republic Services, Inc., its subsidiaries, affiliates, employees, officers and directors from and against any and all liabilities, claims, penalties, forfeitures, suits and the costs and expenses incident thereto, including costs of defense, settlement, and reasonable attorney's fees, which may be incurred, as a result of death or injuries to any person, or damage to any property, contamination of or adverse effects on the environment, caused in whole or in part by the Customer, its employees, or subcontractors in disposing waste at this Facility. In the event Customer delivers Unacceptable Waste (as determined by Republic) Customer agrees to assume all expenses and obligations with the removal and/or resolution of any effects caused by the delivery of such Unacceptable Waste.

Indemnización. Cliente acuerda indemnizar, mantener inmune, y defender Republic Services, Inc., sus subsidiarios, compañías, divisiones, empleados, oficiales y directores contra de cualquiera y de todas responsabilidades, demandas, penas, pérdidas, juicios, pleitos y los costos incidente además, incluyendo costos de defensa, de acuerdo judicial, y de honorarios razonables del abogado, que pueden ser incurridos en, o como resultado de, la muerte o herida personal a cualquier persona, o daños a cualquier característica, propiedad, contaminación de la tierra o efectos ilícitos en esta Facilidad, causado entero o en parte por el cliente, sus empleados, o sus subcontratistas en botar basura en esta Facilidad. En el caso que el Cliente entrega, bota, basura (según lo determinado por Republic) en este Establecimiento basura inaceptable en los reglamentos de este Establecimiento, el Cliente se compromete asumir todos los costos y obligaciones con el retiro y/o la resolución de cualquier dano(s) causado por la entrega de tal basura inaceptable.



NON-HAZARDOUS WASTE MANIFEST

MANIFEST # 11883

GENERATOR INFORMATION

Generator Name: Tronox LLC

Address: P.O. Box 55

City: Henderson County: Clark

State: NV Zip: 89009

Site Location (if different): 560 W. Lake Mead

Henderson, NV 89015 (702) 592-7727

CUSTOMER/BILLING INFORMATION

Billing Name: NGE LLC c/o Northgate Environment Management

Address: 300 Frank Ogawa Plaza, Ste 510

City: Oakland County: Alameda

State: CA Zip: 94612

Republic Services Approval #	Description of Waste	Volume/Weight	Expiration Date	Container Type
38251011244	Soil for disposal		12-31-2011	Tractor with Dump Trailer(s)
	RZ- _____ # _____	37.44		

*Attach Additional Sheet if necessary

I hereby certify that the above-described materials are non-hazardous wastes as defined by 40 CFR 261 or any applicable state law. Further, that the above named materials are properly classified, described, packaged, marked and labeled, and are in proper condition for transportation according to the applicable regulations of the Department of Transportation.

Susan Crowley Generator/Authorized Agent Name Tom Crowley Signature Date Shipped

TRANSPORTER INFORMATION

Transporter Name: Las Vegas Paving

DOT # 191949

Address: 4420 S. Decatur

Truck Number: 2460

Las Vegas, NV 89103

Phone Number: (702) 353-4355

I certify no hazardous waste or other regulated substance was knowingly introduced to the waste while in my custody. The waste transported in this vehicle is the waste identified above, to the best of my knowledge.

Graig Honish Name of Authorized Agent Graig Honish Signature 10-5-10 Date Delivered

DISPOSAL SITE INFORMATION

Site Name: Apex Regional Landfill

Phone No. (702) 599-5920

Address: 13550 U.S. Hwy 93 Las Vegas, NV

I hereby acknowledge receipt of the above described materials

Hobden, Se Derek Name (Print or Type) Se Derek Hobden Signature 05 Oct 10 Date Received

81 Environmental Tech
13550 N Highway 93
Las Vegas, NV 89165

Ticket Type: INBOUND INVOICE

Ticket Number: 1789
Date: 10/05/2010
Time In: 11:51 pm
Time Out: 12:14 am

Customer: 001011 - NGE, LLC c/o Northgate Environ Mgmt

Vehicle/Container: 82418P
Contract: Northgate Env. On Site Soils 3825 11
Comment: 3825 10 11244

Gross Weight: 134,360 LB Manual In
Tare Weight: 66,820 LB Scale Out
Net Weight: 67540 LB
Net Tons: 33.77

BOL: 11885

Origin	Yards	Material	Billing	Quantity
Not Applicable	0.00 YD	SW CONTAMINATED SOIL	33.77	TN

Driver:

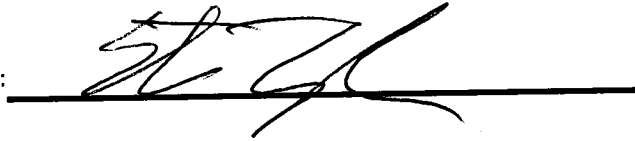

Weighmaster:

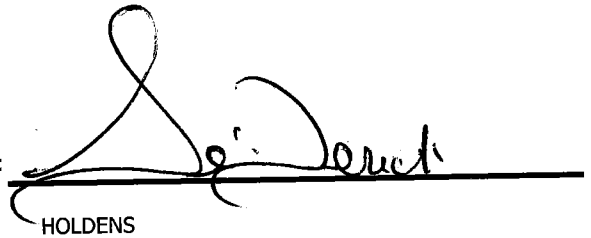

HOLDENS

Indemnification. Customer agrees, by signature above, to indemnify, hold harmless, and defend Republic Services, Inc., its subsidiaries, affiliates, employees, officers and directors from and against any and all liabilities, claims, penalties, forfeitures, suits and the costs and expenses incident thereto, including costs of defense, settlement, and reasonable attorney's fees, which may be incurred, as a result of death or injuries to any person, or damage to any property, contamination of or adverse effects on the environment, caused in whole or in part by the Customer, its employees, or subcontractors in disposing waste at this Facility. In the event Customer delivers Unacceptable Waste (as determined by Republic) Customer agrees to assume all expenses and obligations with the removal and/or resolution of any effects caused by the delivery of such Unacceptable Waste.

Indemnización. Cliente acuerda indemnizar, mantener inmune, y defender Republic Services, Inc., sus subsidiarios, compañías, divisiones, empleados, oficiales y directores contra de cualquiera y de todas responsabilidades, demandas, penas, pérdidas, juicios, pleitos y los costos incidente además, incluyendo costos de defensa, de acuerdo judicial, y de honorarios razonables del abogado, que pueden ser incurridos en, o como resultado de, la muerte o herida personal a cualquier persona, o daños a cualquier característica, propiedad, contaminación de la tierra o efectos ilícitos en esta Facilidad, causado entero o en parte por el cliente, sus empleados, o sus subcontratistas en botar basura en esta Facilidad. En el caso que el Cliente entrega, bota, basura (según lo determinado por Republic) en este Establecimiento basura inaceptable en los reglamentos de este Establecimiento, el Cliente se compromete asumir todos los costos y obligaciones con el retiro y/o la resolución de cualquier dano(s) causado por la entrega de tal basura inaceptable.



NON-HAZARDOUS WASTE MANIFEST

MANIFEST # 11885

GENERATOR INFORMATION

Generator Name: Tronox LLC

Address: P.O. Box 55

City: Henderson County: Clark

State: NV Zip: 89009

Site Location (if different): 560 W. Lake Mead
Henderson, NV 89015 (702) 592-7727

CUSTOMER/BILLING INFORMATION

Billing Name: NGE LLC c/o Northgate Environment Management

Address: 300 Frank Ogawa Plaza, Ste 510

City: Oakland County: Alameda

State: CA Zip: 94612

Republic Services Approval #	Description of Waste	Volume/Weight	Expiration Date	Container Type
38251011244	Soil for disposal	33 ²² / _{ton}	12-31-2011	Tractor with Dump Trailer(s)
	RZ- _____ # _____			

*Attach Additional Sheet if necessary

I hereby certify that the above-described materials are non-hazardous wastes as defined by 40 CFR 261 or any applicable state law. Further, that the above named materials are properly classified, described, packaged, marked and labeled, and are in proper condition for transportation according to the applicable regulations of the Department of Transportation.

Susan Crowley
Generator/Authorized Agent Name

Susan Crowley
Signature

Date Shipped

TRANSPORTER INFORMATION

Transporter Name: Las Vegas Paving

DOT # 191949

Address: 4420 S. Decatur

Truck Number: 220

Las Vegas, NV 89103

Phone Number: (702) 353-4355

I certify no hazardous waste or other regulated substance was knowingly introduced to the waste while in my custody. The waste transported in this vehicle is the waste identified above, to the best of my knowledge.

STEVE TAYLOR
Name of Authorized Agent

Steve Taylor
Signature

10-5-10
Date Delivered

DISPOSAL SITE INFORMATION

Site Name: Apex Regional Landfill

Phone No. (702) 599-5920

Address: 13550 U.S. Hwy 93 Las Vegas, NV

I hereby acknowledge receipt of the above described materials
Holden, Se' Derrick
Name (Print or Type)

Se' Derrick Holden
Signature

05 Oct 10
Date Received

81 Environmental Tech
13550 N Highway 93
Las Vegas, NV 89165

Ticket Type: INBOUND INVOICE

Ticket Number: 1790
Date: 10/05/2010
Time In: 11:50 pm
Time Out: 12:14 am

Customer: 001011 - NGE, LLC c/o Northgate Environ Mgmt

Vehicle/Container: 35903A
Contract: Northgate Env. On Site Soils 3825 11
Comment: 3825 10 11244

Gross Weight: 128,300 LB Manual In
Tare Weight: 55,660 LB Manual Out
Net Weight: 72640 LB
Net Tons: 36.32

BOL: 11884

Origin	Yards	Material	Billing	Quantity
Not Applicable	0.00 YD	SW CONTAMINATED SOIL	36.32	TN

Driver: _____

Weighmaster: _____

HOLDENS

Indemnification. Customer agrees, by signature above, to indemnify, hold harmless, and defend Republic Services, Inc., its subsidiaries, affiliates, employees, officers and directors from and against any and all liabilities, claims, penalties, forfeitures, suits and the costs and expenses incident thereto, including costs of defense, settlement, and reasonable attorney's fees, which may be incurred, as a result of death or injuries to any person, or damage to any property, contamination of or adverse effects on the environment, caused in whole or in part by the Customer, its employees, or subcontractors in disposing waste at this Facility. In the event Customer delivers Unacceptable Waste (as determined by Republic) Customer agrees to assume all expenses and obligations with the removal and/or resolution of any effects caused by the delivery of such Unacceptable Waste.

Indemnización. Cliente acuerda indemnizar, mantener inmune, y defender Republic Services, Inc., sus subsidiarios, compañías, divisiones, empleados, oficiales y directores contra de cualquiera y de todas responsabilidades, demandas, penas, pérdidas, juicios, pleitos y los costos incidente además, incluyendo costos de defensa, de acuerdo judicial, y de honorarios razonables del abogado, que pueden ser incurridos en, o como resultado de, la muerte o herida personal a cualquier persona, o daños a cualquier característica, propiedad, contaminación de la tierra o efectos ilícitos en esta Facilidad, causado entero o en parte por el cliente, sus empleados, o sus subcontratistas en botar basura en esta Facilidad. En el caso que el Cliente entrega, bota, basura (según lo determinado por Republic) en este Establecimiento basura inaceptable en los reglamentos de este Establecimiento, el Cliente se compromete asumir todos los costos y obligaciones con el retiro y/o la resolución de cualquier dano(s) causado por la entrega de tal basura inaceptable.



NON-HAZARDOUS WASTE MANIFEST

MANIFEST # 11884

GENERATOR INFORMATION

Generator Name: Tronox LLC

Address: P.O. Box 55

City: Henderson County: Clark

State: NV Zip: 89009

Site Location (if different): 560 W. Lake Mead

Henderson, NV 89015 (702) 592-7727

CUSTOMER/BILLING INFORMATION

Billing Name: NGE LLC c/o Northgate Environment Management

Address: 300 Frank Ogawa Plaza, Ste 510

City: Oakland County: Alameda

State: CA Zip: 94612

Republic Services Approval #	Description of Waste	Volume/Weight	Expiration Date	Container Type
38251011244	Soil for disposal	36 ³⁵ / _{ton}	12-31-2011	Tractor with Dump Trailer(s)
	RZ- _____ # _____			

*Attach Additional Sheet if necessary

I hereby certify that the above-described materials are non-hazardous wastes as defined by 40 CFR 261 or any applicable state law. Further, that the above named materials are properly classified, described, packaged, marked and labeled, and are in proper condition for transportation according to the applicable regulations of the Department of Transportation.

Susan Crowley (Signature) Date Shipped

TRANSPORTER INFORMATION

Transporter Name: Las Vegas Paving

DOT # 191949

Address: 4420 S. Decatur

Truck Number: 07

Las Vegas, NV 89103

Phone Number: (702) 353-4355

I certify no hazardous waste or other regulated substance was knowingly introduced to the waste while in my custody. The waste transported in this vehicle is the waste identified above, to the best of my knowledge.

Werdco BC (Signature) JAY MASON Date Delivered 10-5-10

DISPOSAL SITE INFORMATION

Site Name: Apex Regional Landfill

Phone No. (702) 599-5920

Address: 13550 U.S. Hwy 93 Las Vegas, NV

I hereby acknowledge receipt of the above described materials

Holden, S. Dennis (Signature) DeDerrick Holden Date Received 05 Oct 10

81 Environmental Tech
13550 N Highway 93
Las Vegas, NV 89165

Ticket Type: INBOUND INVOICE

Ticket Number: 1791
Date: 10/05/2010
Time In: 11:59 pm
Time Out: 12:20 am

Customer: 001011 - NGE, LLC c/o Northgate Environ Mgmt

Vehicle/Container: 81494P
Contract: Northgate Env. On Site Soils 3825 11
Comment: 3825 10 11244

Gross Weight: 125,220 LB Manual In
Tare Weight: 51,060 LB Manual Out
Net Weight: 74160 LB
Net Tons: 37.08

BOL: 11886

Origin	Yards	Material	Billing	Quantity
Not Applicable	0.00 YD	SW CONTAMINATED SOIL	37.08	TN

Driver: _____



Weighmaster: _____



HOLDENS

Indemnification. Customer agrees, by signature above, to indemnify, hold harmless, and defend Republic Services, Inc., its subsidiaries, affiliates, employees, officers and directors from and against any and all liabilities, claims, penalties, forfeitures, suits and the costs and expenses incident thereto, including costs of defense, settlement, and reasonable attorney's fees, which may be incurred, as a result of death or injuries to any person, or damage to any property, contamination of or adverse effects on the environment, caused in whole or in part by the Customer, its employees, or subcontractors in disposing waste at this Facility. In the event Customer delivers Unacceptable Waste (as determined by Republic) Customer agrees to assume all expenses and obligations with the removal and/or resolution of any effects caused by the delivery of such Unacceptable Waste.

Indemnización. Cliente acuerda indemnizar, mantener inmune, y defender Republic Services, Inc., sus subsidiarios, compañías, divisiones, empleados, oficiales y directores contra de cualquiera y de todas responsabilidades, demandas, penas, pérdidas, juicios, pleitos y los costos incidente además, incluyendo costos de defensa, de acuerdo judicial, y de honorarios razonables del abogado, que pueden ser incurridos en, o como resultado de, la muerte o herida personal a cualquier persona, o daños a cualquier característica, propiedad, contaminación de la tierra o efectos ilícitos en esta Facilidad, causado entero o en parte por el cliente, sus empleados, o sus subcontratistas en botar basura en esta Facilidad. En el caso que el Cliente entrega, bota, basura (según lo determinado por Republic) en este Establecimiento basura inaceptable en los reglamentos de este Establecimiento, el Cliente se compromete asumir todos los costos y obligaciones con el retiro y/o la resolución de cualquier dano(s) causado por la entrega de tal basura inaceptable.



NON-HAZARDOUS WASTE MANIFEST

MANIFEST # 11886

GENERATOR INFORMATION

Generator Name: Tronox LLC

Address: P.O. Box 55

City: Henderson County: Clark

State: NV Zip: 89009

Site Location (if different): 560 W. Lake Mead

Henderson, NV 89015 (702) 592-7727

CUSTOMER/BILLING INFORMATION

Billing Name: NGE LLC c/o Northgate Environment Management

Address: 300 Frank Ogawa Plaza, Ste 510

City: Oakland County: Alameda

State: CA Zip: 94612

Republic Services Approval #	Description of Waste	Volume/Weight	Expiration Date	Container Type
38251011244	Soil for disposal	37 ⁰⁰ / ₁₅₀	12-31-2011	Tractor with Dump Trailer(s)
	RZ- _____ # _____			

*Attach Additional Sheet if necessary

I hereby certify that the above-described materials are non-hazardous wastes as defined by 40 CFR 261 or any applicable state law. Further, that the above named materials are properly classified, described, packaged, marked and labeled, and are in proper condition for transportation according to the applicable regulations of the Department of Transportation.

Susan Crowley *Tom Crowley*
 Generator/Authorized Agent Name Signature Date Shipped

TRANSPORTER INFORMATION

Transporter Name: Las Vegas Paving

DOT # 191949

Address: 4420 S. Decatur

Truck Number: 125

Las Vegas, NV 89103

Phone Number: (702) 353-4355

I certify no hazardous waste or other regulated substance was knowingly introduced to the waste while in my custody. The waste transported in this vehicle is the waste identified above, to the best of my knowledge.

Calvin Paguyo *Calvin Paguyo* 10-05-10
 Name of Authorized Agent Signature Date Delivered

DISPOSAL SITE INFORMATION

Site Name: Apex Regional Landfill

Phone No. (702) 599-5920

Address: 13550 U.S. Hwy 93 Las Vegas, NV

I hereby acknowledge receipt of the above described materials
Holden S. Jensen *Derrick Holden* 05 Oct 10
 Name (Print or Type) Signature Date Received

81 Environmental Tech
13550 N Highway 93
Las Vegas, NV 89165

Ticket Type: INBOUND INVOICE

Ticket Number: 1792
Date: 10/06/2010
Time In: 12:04 am
Time Out: 12:28 am

Customer: 001011 - NGE, LLC c/o Northgate Environ Mgmt

Vehicle/Container: 86053P
Contract: Northgate Env. On Site Soils 3825 11
Comment: 3825 10 11244

Gross Weight: 125,520 LB Manual In
Tare Weight: 56,220 LB Scale Out
Net Weight: 69300 LB
Net Tons: 34.65

BOL: 11887

Origin	Yards	Material	Billing	Quantity
Not Applicable	0.00 YD	SW CONTAMINATED SOIL	34.65	TN

Driver:



Weighmaster:

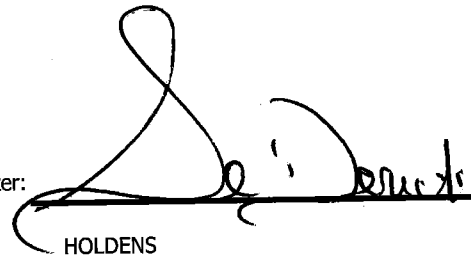

HOLDENS

Indemnification. Customer agrees, by signature above, to indemnify, hold harmless, and defend Republic Services, Inc., its subsidiaries, affiliates, employees, officers and directors from and against any and all liabilities, claims, penalties, forfeitures, suits and the costs and expenses incident thereto, including costs of defense, settlement, and reasonable attorney's fees, which may be incurred, as a result of death or injuries to any person, or damage to any property, contamination of or adverse effects on the environment, caused in whole or in part by the Customer, its employees, or subcontractors in disposing waste at this Facility. In the event Customer delivers Unacceptable Waste (as determined by Republic) Customer agrees to assume all expenses and obligations with the removal and/or resolution of any effects caused by the delivery of such Unacceptable Waste.

Indemnización. Cliente acuerda indemnizar, mantener inmune, y defender Republic Services, Inc., sus subsidiarios, compañías, divisiones, empleados, oficiales y directores contra de cualquiera y de todas responsabilidades, demandas, penas, pérdidas, juicios, pleitos y los costos incidente además, incluyendo costos de defensa, de acuerdo judicial, y de honorarios razonables del abogado, que pueden ser incurridos en, o como resultado de, la muerte o herida personal a cualquier persona, o daños a cualquier característica, propiedad, contaminación de la tierra o efectos ilícitos en esta Facilidad, causado entero o en parte por el cliente, sus empleados, o sus subcontratistas en botar basura en esta Facilidad. En el caso que el Cliente entrega, bota, basura (según lo determinado por Republic) en este Establecimiento basura inaceptable en los reglamentos de este Establecimiento, el Cliente se compromete asumir todos los costos y obligaciones con el retiro y/o la resolución de cualquier dano(s) causado por la entrega de tal basura inaceptable.



NON-HAZARDOUS WASTE MANIFEST

MANIFEST # 11887

GENERATOR INFORMATION

Generator Name: Tronox LLC

Address: P.O. Box 55

City: Henderson County: Clark

State: NV Zip: 89009

Site Location (if different): 560 W. Lake Mead
Henderson, NV 89015 (702) 592-7727

CUSTOMER/BILLING INFORMATION

Billing Name: NGE LLC c/o Northgate Environment Management

Address: 300 Frank Ogawa Plaza, Ste 510

City: Oakland County: Alameda

State: CA Zip: 94612

Table with 5 columns: Republic Services Approval #, Description of Waste, Volume/Weight, Expiration Date, Container Type. Row 1: 38251011244, Soil for disposal, 34.65 tons, 12-31-2011, Tractor with Dump Trailer(s). Row 2: RZ- #

*Attach Additional Sheet if necessary

I hereby certify that the above-described materials are non-hazardous wastes as defined by 40 CFR 261 or any applicable state law. Further, that the above named materials are properly classified, described, packaged, marked and labeled, and are in proper condition for transportation according to the applicable regulations of the Department of Transportation.

Susan Crowley
Generator/Authorized Agent Name Signature Date Shipped

TRANSPORTER INFORMATION

Transporter Name: Las Vegas Paving

DOT # 191949

Address: 4420 S. Decatur

Truck Number: 261

Las Vegas, NV 89103

Phone Number: (702) 353-4355

I certify no hazardous waste or other regulated substance was knowingly introduced to the waste while in my custody. The waste transported in this vehicle is the waste identified above, to the best of my knowledge.

Name of Authorized Agent Signature Date Delivered

DISPOSAL SITE INFORMATION

Site Name: Apex Regional Landfill

Phone No. (702) 599-5920

Address: 13550 U.S. Hwy 93 Las Vegas, NV

I hereby acknowledge receipt of the above described materials
Name (Print or Type) Signature Date Received

81 Environmental Tech
13550 N Highway 93
Las Vegas, NV 89165

Ticket Type: INBOUND INVOICE

Ticket Number: 1793
Date: 10/06/2010
Time In: 12:10 am
Time Out: 12:32 am

Customer: 001011 - NGE, LLC c/o Northgate Environ Mgmt

Vehicle/Container: 76810P
Contract: Northgate Env. On Site Soils 3825 11
Comment: 3825 10 11244

Gross Weight: 125,920 LB Manual In
Tare Weight: 54,780 LB Manual Out
Net Weight: 71140 LB
Net Tons: 35.57

BOL: 11888

Origin	Yards	Material	Billing	Quantity
Not Applicable	0.00 YD	SW CONTAMINATED SOIL	35.57	TN

Driver:

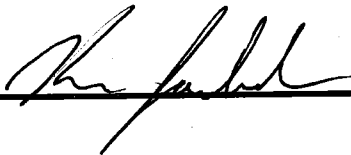

Weighmaster:

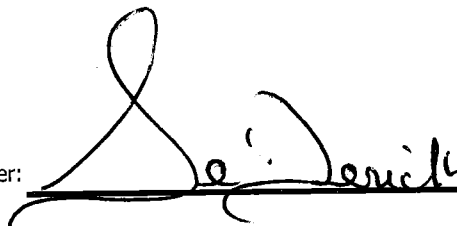

HOLDENS

Indemnification. Customer agrees, by signature above, to indemnify, hold harmless, and defend Republic Services, Inc., its subsidiaries, affiliates, employees, officers and directors from and against any and all liabilities, claims, penalties, forfeitures, suits and the costs and expenses incident thereto, including costs of defense, settlement, and reasonable attorney's fees, which may be incurred, as a result of death or injuries to any person, or damage to any property, contamination of or adverse effects on the environment, caused in whole or in part by the Customer, its employees, or subcontractors in disposing waste at this Facility. In the event Customer delivers Unacceptable Waste (as determined by Republic) Customer agrees to assume all expenses and obligations with the removal and/or resolution of any effects caused by the delivery of such Unacceptable Waste.

Indemnización. Cliente acuerda indemnizar, mantener inmune, y defender Republic Services, Inc., sus subsidiarios, compañías, divisiones, empleados, oficiales y directores contra de cualquiera y de todas responsabilidades, demandas, penas, pérdidas, juicios, pleitos y los costos incidente además, incluyendo costos de defensa, de acuerdo judicial, y de honorarios razonables del abogado, que pueden ser incurridos en, o como resultado de, la muerte o herida personal a cualquier persona, o daños a cualquier característica, propiedad, contaminación de la tierra o efectos ilícitos en esta Facilidad, causado entero o en parte por el cliente, sus empleados, o sus subcontratistas en botar basura en esta Facilidad. En el caso que el Cliente entrega, bota, basura (según lo determinado por Republic) en este Establecimiento basura inaceptable en los reglamentos de este Establecimiento, el Cliente se compromete asumir todos los costos y obligaciones con el retiro y/o la resolución de cualquier dano(s) causado por la entrega de tal basura inaceptable.



NON-HAZARDOUS WASTE MANIFEST

MANIFEST # 11888

GENERATOR INFORMATION

Generator Name: Tronox LLC
Address: P.O. Box 55
City: Henderson County: Clark
State: NV Zip: 89009
Site Location (if different): 560 W. Lake Mead
Henderson, NV 89015 (702) 592-7727

CUSTOMER/BILLING INFORMATION

Billing Name: NGE LLC c/o Northgate Environment Management
Address: 300 Frank Ogawa Plaza, Ste 510
City: Oakland County: Alameda
State: CA Zip: 94612

Table with 5 columns: Republic Services Approval #, Description of Waste, Volume/Weight, Expiration Date, Container Type. Row 1: 38251011244, Soil for disposal, 35 5/10 ton, 12-31-2011, Tractor with Dump Trailer(s).

*Attach Additional Sheet if necessary

I hereby certify that the above-described materials are non-hazardous wastes as defined by 40 CFR 261 or any applicable state law. Further, that the above named materials are properly classified, described, packaged, marked and labeled, and are in proper condition for transportation according to the applicable regulations of the Department of Transportation.

Susan Crowley (Signature)
Generator/Authorized Agent Name Signature Date Shipped

TRANSPORTER INFORMATION

Transporter Name: Las Vegas Paving DOT # 191949
Address: 4420 S. Decatur Truck Number: 241
Las Vegas, NV 89103 Phone Number: (702) 353-4355

I certify no hazardous waste or other regulated substance was knowingly introduced to the waste while in my custody. The waste transported in this vehicle is the waste identified above, to the best of my knowledge.

Ken Jackson (Signature)
Name of Authorized Agent Signature Date Delivered 10-5-2010

DISPOSAL SITE INFORMATION

Site Name: Apex Regional Landfill Phone No. (702) 599-5920
Address: 13550 U.S. Hwy 93 Las Vegas, NV

I hereby acknowledge receipt of the above described materials
Holden, Se Dench (Signature)
Name (Print or Type) Signature Date Received 06 Oct 10

81 Environmental Tech
13550 N Highway 93
Las Vegas, NV 89165

Ticket Type: INBOUND INVOICE

Ticket Number: 1794
Date: 10/06/2010
Time In: 12:23 am
Time Out: 12:47 am

Customer: 001011 - NGE, LLC c/o Northgate Environ Mgmt

Vehicle/Container: 34330A
Contract: Northgate Env. On Site Soils 3825 11
Comment: 3825 10 11244

Gross Weight: 122,240 LB Manual In
Tare Weight: 53,240 LB Scale Out
Net Weight: 69000 LB
Net Tons: 34.50

BOL: 11889

Origin	Yards	Material	Billing	Quantity
Not Applicable	0.00 YD	SW CONTAMINATED SOIL	34.50	TN

Driver:



Weighmaster:

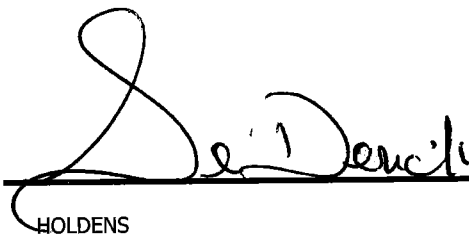

HOLDENS

Indemnification. Customer agrees, by signature above, to indemnify, hold harmless, and defend Republic Services, Inc., its subsidiaries, affiliates, employees, officers and directors from and against any and all liabilities, claims, penalties, forfeitures, suits and the costs and expenses incident thereto, including costs of defense, settlement, and reasonable attorney's fees, which may be incurred, as a result of death or injuries to any person, or damage to any property, contamination of or adverse effects on the environment, caused in whole or in part by the Customer, its employees, or subcontractors in disposing waste at this Facility. In the event Customer delivers Unacceptable Waste (as determined by Republic) Customer agrees to assume all expenses and obligations with the removal and/or resolution of any effects caused by the delivery of such Unacceptable Waste.

Indemnización. Cliente acuerda indemnizar, mantener inmune, y defender Republic Services, Inc., sus subsidiarios, compañías, divisiones, empleados, oficiales y directores contra de cualquiera y de todas responsabilidades, demandas, penas, pérdidas, juicios, pleitos y los costos incidente además, incluyendo costos de defensa, de acuerdo judicial, y de honorarios razonables del abogado, que pueden ser incurridos en, o como resultado de, la muerte o herida personal a cualquier persona, o daños a cualquier característica, propiedad, contaminación de la tierra o efectos ilícitos en esta Facilidad, causado entero o en parte por el cliente, sus empleados, o sus subcontratistas en botar basura en esta Facilidad. En el caso que el Cliente entrega, bota, basura (según lo determinado por Republic) en este Establecimiento basura inaceptable en los reglamentos de este Establecimiento, el Cliente se compromete asumir todos los costos y obligaciones con el retiro y/o la resolución de cualquier dano(s) causado por la entrega de tal basura inaceptable.



NON-HAZARDOUS WASTE MANIFEST

MANIFEST # 11889

GENERATOR INFORMATION

Generator Name: Tronox LLC
Address: P.O. Box 55
City: Henderson County: Clark
State: NV Zip: 89009
Site Location (if different): 560 W. Lake Mead
Henderson, NV 89015 (702) 592-7727

CUSTOMER/BILLING INFORMATION

Billing Name: NGE LLC c/o Northgate Environment Management
Address: 300 Frank Ogawa Plaza, Ste 510
City: Oakland County: Alameda
State: CA Zip: 94612

Table with 5 columns: Republic Services Approval #, Description of Waste, Volume/Weight, Expiration Date, Container Type. Row 1: 38251011244, Soil for disposal, 34.50 ton, 12-31-2011, Tractor with Dump Trailer(s).

*Attach Additional Sheet if necessary

I hereby certify that the above-described materials are non-hazardous wastes as defined by 40 CFR 261 or any applicable state law. Further, that the above named materials are properly classified, described, packaged, marked and labeled, and are in proper condition for transportation according to the applicable regulations of the Department of Transportation.

Susan Crowley (Signature)
Generator/Authorized Agent Name Signature Date Shipped

TRANSPORTER INFORMATION

Transporter Name: Las Vegas Paving DOT # 191949
Address: 4420 S. Decatur Truck Number: 981
Las Vegas, NV 89103 Phone Number: (702) 353-4355

I certify no hazardous waste or other regulated substance was knowingly introduced to the waste while in my custody. The waste transported in this vehicle is the waste identified above, to the best of my knowledge.

Tom Rawlison (Signature)
Name of Authorized Agent Signature Date Delivered 10-5-10

DISPOSAL SITE INFORMATION

Site Name: Apex Regional Landfill Phone No. (702) 599-5920
Address: 13550 U.S. Hwy 93 Las Vegas, NV

I hereby acknowledge receipt of the above described materials
Holden Se Drick (Signature)
Name (Print or Type) Signature Date Received 06 Oct 10

81 Environmental Tech
13550 N Highway 93
Las Vegas, NV 89165

Ticket Type: INBOUND INVOICE

Ticket Number: 1795
Date: 10/06/2010
Time In: 12:26 am
Time Out: 12:48 am

Customer: 001011 - NGE, LLC c/o Northgate Environ Mgmt

Vehicle/Container: 81496P
Contract: Northgate Env. On Site Soils 3825 11
Comment: 3825 10 11244

Gross Weight: 119,760 LB Manual In
Tare Weight: 50,360 LB Manual Out
Net Weight: 69,400 LB
Net Tons: 34.70

BOL: 11890

Origin	Yards	Material	Billing Quantity
Not Applicable	0.00 YD	SW CONTAMINATED SOIL	34.70 TN

Driver: _____



Weighmaster: _____



HOLDENS

Indemnification. Customer agrees, by signature above, to indemnify, hold harmless, and defend Republic Services, Inc., its subsidiaries, affiliates, employees, officers and directors from and against any and all liabilities, claims, penalties, forfeitures, suits and the costs and expenses incident thereto, including costs of defense, settlement, and reasonable attorney's fees, which may be incurred, as a result of death or injuries to any person, or damage to any property, contamination of or adverse effects on the environment, caused in whole or in part by the Customer, its employees, or subcontractors in disposing waste at this Facility. In the event Customer delivers Unacceptable Waste (as determined by Republic) Customer agrees to assume all expenses and obligations with the removal and/or resolution of any effects caused by the delivery of such Unacceptable Waste.

Indemnización. Cliente acuerda indemnizar, mantener inmune, y defender Republic Services, Inc., sus subsidiarios, compañías, divisiones, empleados, oficiales y directores contra de cualquiera y de todas responsabilidades, demandas, penas, pérdidas, juicios, pleitos y los costos incidente además, incluyendo costos de defensa, de acuerdo judicial, y de honorarios razonables del abogado, que pueden ser incurridos en, o como resultado de, la muerte o herida personal a cualquier persona, o daños a cualquier característica, propiedad, contaminación de la tierra o efectos ilícitos en esta Facilidad, causado entero o en parte por el cliente, sus empleados, o sus subcontratistas en botar basura en esta Facilidad. En el caso que el Cliente entrega, bota, basura (según lo determinado por Republic) en este Establecimiento basura inaceptable en los reglamentos de este Establecimiento, el Cliente se compromete asumir todos los costos y obligaciones con el retiro y/o la resolución de cualquier dano(s) causado por la entrega de tal basura inaceptable.



NON-HAZARDOUS WASTE MANIFEST

MANIFEST # 11890

GENERATOR INFORMATION

Generator Name: Tronox LLC
Address: P.O. Box 55
City: Henderson County: Clark
State: NV Zip: 89009
Site Location (if different): 560 W. Lake Mead
Henderson, NV 89015 (702) 592-7727

CUSTOMER/BILLING INFORMATION

Billing Name: NGE LLC c/o Northgate Environment Management
Address: 300 Frank Ogawa Plaza, Ste 510
City: Oakland County: Alameda
State: CA Zip: 94612

Table with 5 columns: Republic Services Approval #, Description of Waste, Volume/Weight, Expiration Date, Container Type. Row 1: 38251011244, Soil for disposal, 34 70/ton, 12-31-2011, Tractor with Dump Trailer(s).

*Attach Additional Sheet if necessary

I hereby certify that the above-described materials are non-hazardous wastes as defined by 40 CFR 261 or any applicable state law. Further, that the above named materials are properly classified, described, packaged, marked and labeled, and are in proper condition for transportation according to the applicable regulations of the Department of Transportation.

Susan Crowley (Signature)
Generator/Authorized Agent Name Signature Date Shipped

TRANSPORTER INFORMATION

Transporter Name: Las Vegas Paving DOT # 191949
Address: 4420 S. Decatur Truck Number: 145
Las Vegas, NV 89103 Phone Number: (702) 353-4355

I certify no hazardous waste or other regulated substance was knowingly introduced to the waste while in my custody. The waste transported in this vehicle is the waste identified above, to the best of my knowledge.

Harry McPike (Signature) Date Delivered: 10-5-10
Name of Authorized Agent Signature

DISPOSAL SITE INFORMATION

Site Name: Apex Regional Landfill Phone No. (702) 599-5920
Address: 13550 U.S. Hwy 93 Las Vegas, NV

I hereby acknowledge receipt of the above described materials
Holden, Derrick (Signature) Date Received: 06 Oct 10
Name (Print or Type) Signature

81 Environmental Tech
13550 N Highway 93
Las Vegas, NV 89165

Ticket Type: INBOUND INVOICE

Ticket Number: 1796
Date: 10/06/2010
Time In: 12:30 am
Time Out: 12:54 am

Customer: 001011 - NGE, LLC c/o Northgate Environ Mgmt

Vehicle/Container: 76811P
Contract: Northgate Env. On Site Soils 3825 11
Comment: 3825 10 11244

Gross Weight: 123,520 LB Manual In
Tare Weight: 52,920 LB Scale Out
Net Weight: 70600 LB
Net Tons: 35.30

BOL: 11981

Origin	Yards	Material	Billing	Quantity
Not Applicable	0.00 YD	SW CONTAMINATED SOIL	35.30	TN

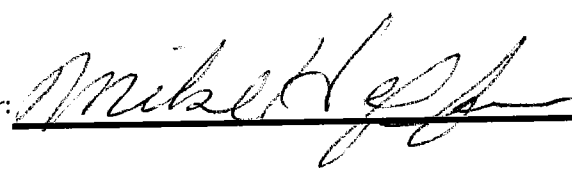
Driver: 

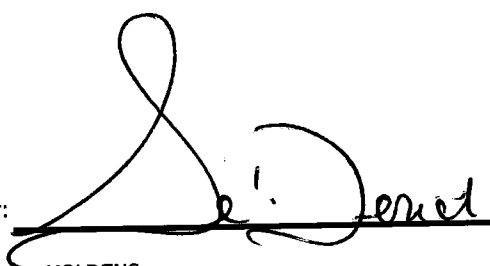
Weighmaster: 
HOLDENS

Indemnification. Customer agrees, by signature above, to indemnify, hold harmless, and defend Republic Services, Inc., its subsidiaries, affiliates, employees, officers and directors from and against any and all liabilities, claims, penalties, forfeitures, suits and the costs and expenses incident thereto, including costs of defense, settlement, and reasonable attorney's fees, which may be incurred, as a result of death or injuries to any person, or damage to any property, contamination of or adverse effects on the environment, caused in whole or in part by the Customer, its employees, or subcontractors in disposing waste at this Facility. In the event Customer delivers Unacceptable Waste (as determined by Republic) Customer agrees to assume all expenses and obligations with the removal and/or resolution of any effects caused by the delivery of such Unacceptable Waste.

Indemnización. Cliente acuerda indemnizar, mantener inmune, y defender Republic Services, Inc., sus subsidiarios, companias, divisiones, empleados, oficiales y directores contra de cualquiera y de todas responsabilidades, demandas, penas, pérdidas, juicios, pleitos y los costos incidente además, incluyendo costos de defensa, de acuerdo judicial, y de honorarios razonables del abogado, que pueden ser incurridos en, o como resultado de, la muerte o herida personal a cualquier persona, o daños a cualquier característica, propiedad, contaminación de la tierra o efectos ilicitos en esta Facilidat. En el caso que el Cliente entrega, bota, basura (según lo determinado por Republic) en este Establecimiento basura inaceptable en los reglamentos de este Establecimiento, el Cliente se compromete asumir todos los costos y obligaciones con el retiro y/o la resolución de cualquier dano(s) causado por la entrega de tal basura inaceptable.



NON-HAZARDOUS WASTE MANIFEST

MANIFEST # 11891

GENERATOR INFORMATION

Generator Name: Tronox LLC

Address: P.O. Box 55

City: Henderson County: Clark

State: NV Zip: 89009

Site Location (if different): 560 W. Lake Mead

Henderson, NV 89015 (702) 592-7727

CUSTOMER/BILLING INFORMATION

Billing Name: NGE LLC c/o Northgate Environment Management

Address: 300 Frank Ogawa Plaza, Ste 510

City: Oakland County: Alameda

State: CA Zip: 94612

Table with 5 columns: Republic Services Approval #, Description of Waste, Volume/Weight, Expiration Date, Container Type. Row 1: 38251011244, Soil for disposal, 35 30/70 ton, 12-31-2011, Tractor with Dump Trailer(s). Row 2: RZ- #

*Attach Additional Sheet if necessary

I hereby certify that the above-described materials are non-hazardous wastes as defined by 40 CFR 261 or any applicable state law. Further, that the above named materials are properly classified, described, packaged, marked and labeled, and are in proper condition for transportation according to the applicable regulations of the Department of Transportation.

Susan Crowley (Name), Tom Crowley (Signature), Date Shipped

TRANSPORTER INFORMATION

Transporter Name: Las Vegas Paving

DOT # 191949

Address: 4420 S. Decatur

Truck Number: 272

Las Vegas, NV 89103

Phone Number: (702) 353-4355

I certify no hazardous waste or other regulated substance was knowingly introduced to the waste while in my custody. The waste transported in this vehicle is the waste identified above, to the best of my knowledge.

Mike Hefferon (Name), Mike Hefferon (Signature), 10-5-10 (Date Delivered)

DISPOSAL SITE INFORMATION

Site Name: Apex Regional Landfill

Phone No. (702) 599-5920

Address: 13550 U.S. Hwy 93 Las Vegas, NV

I hereby acknowledge receipt of the above described materials

Holden, Se (Name), Se (Signature), 06 Oct 10 (Date Received)

81 Environmental Tech
13550 N Highway 93
Las Vegas, NV 89165

Ticket Type: INBOUND INVOICE

Ticket Number: 1797
Date: 10/06/2010
Time In: 12:39 am
Time Out: 1:04 am

Customer: 001011 - NGE, LLC c/o Northgate Environ Mgmt

Vehicle/Container: 44165A
Contract: Northgate Env. On Site Soils 3825 11
Comment: 3825 10 11244

Gross Weight: 126,780 LB Manual In
Tare Weight: 48,620 LB Scale Out
Net Weight: 78160 LB
Net Tons: 39.08

BOL: 11892

Origin	Yards	Material	Billing	Quantity
Not Applicable	0.00 YD	SW CONTAMINATED SOIL	39.08	TN

Driver:



Weighmaster:

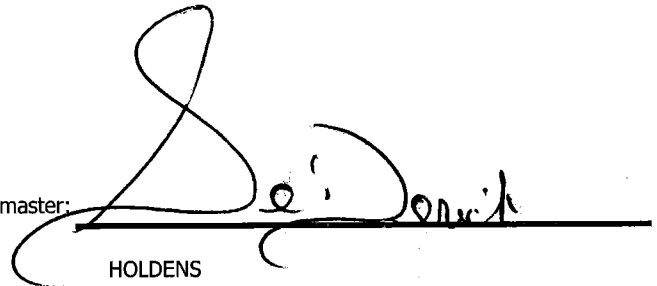

HOLDENS

Indemnification. Customer agrees, by signature above, to indemnify, hold harmless, and defend Republic Services, Inc., its subsidiaries, affiliates, employees, officers and directors from and against any and all liabilities, claims, penalties, forfeitures, suits and the costs and expenses incident thereto, including costs of defense, settlement, and reasonable attorney's fees, which may be incurred, as a result of death or injuries to any person, or damage to any property, contamination of or adverse effects on the environment, caused in whole or in part by the Customer, its employees, or subcontractors in disposing waste at this Facility. In the event Customer delivers Unacceptable Waste (as determined by Republic) Customer agrees to assume all expenses and obligations with the removal and/or resolution of any effects caused by the delivery of such Unacceptable Waste.

Indemnización. Cliente acuerda indemnizar, mantener inmune, y defender Republic Services, Inc., sus subsidiarios, compañías, divisiones, empleados, oficiales y directores contra de cualquiera y de todas responsabilidades, demandas, penas, pérdidas, juicios, pleitos y los costos incidente además, incluyendo costos de defensa, de acuerdo judicial, y de honorarios razonables del abogado, que pueden ser incurridos en, o como resultado de, la muerte o herida personal a cualquier persona, o daños a cualquier característica, propiedad, contaminación de la tierra o efectos ilícitos en esta Facilidad, causado entero o en parte por el cliente, sus empleados, o sus subcontratistas en botar basura en esta Facilidad. En el caso que el Cliente entrega, bota, basura (según lo determinado por Republic) en este Establecimiento basura inaceptable en los reglamentos de este Establecimiento, el Cliente se compromete asumir todos los costos y obligaciones con el retiro y/o la resolución de cualquier dano(s) causado por la entrega de tal basura inaceptable.



NON-HAZARDOUS WASTE MANIFEST

MANIFEST # 11892

GENERATOR INFORMATION

Generator Name: Tronox LLC

Address: P.O. Box 55

City: Henderson County: Clark

State: NV Zip: 89009

Site Location (if different): 560 W. Lake Mead

Henderson, NV 89015 (702) 592-7727

CUSTOMER/BILLING INFORMATION

Billing Name: NGE LLC c/o Northgate Environment Management

Address: 300 Frank Ogawa Plaza, Ste 510

City: Oakland County: Alameda

State: CA Zip: 94612

Table with 5 columns: Republic Services Approval #, Description of Waste, Volume/Weight, Expiration Date, Container Type. Row 1: 38251011244, Soil for disposal, 39 08/10m, 12-31-2011, Tractor with Dump Trailer(s).

*Attach Additional Sheet if necessary

I hereby certify that the above-described materials are non-hazardous wastes as defined by 40 CFR 261 or any applicable state law. Further, that the above named materials are properly classified, described, packaged, marked and labeled, and are in proper condition for transportation according to the applicable regulations of the Department of Transportation.

Susan Crowley (Signature) Generator/Authorized Agent Name Signature Date Shipped

TRANSPORTER INFORMATION

Transporter Name: Las Vegas Paving

DOT # 191949

Address: 4420 S. Decatur

Truck Number: 5001

Las Vegas, NV 89103

Phone Number: (702) 353-4355

I certify no hazardous waste or other regulated substance was knowingly introduced to the waste while in my custody. The waste transported in this vehicle is the waste identified above, to the best of my knowledge.

Ramon (Signature) Name of Authorized Agent Signature Date Delivered 10-5-10

DISPOSAL SITE INFORMATION

Site Name: Apex Regional Landfill

Phone No. (702) 599-5920

Address: 13550 U.S. Hwy 93 Las Vegas, NV

I hereby acknowledge receipt of the above described materials

Holden, Se Derrick (Signature) Name (Print or Type) Signature Date Received 06 Oct 10

81 Environmental Tech
13550 N Highway 93
Las Vegas, NV 89165

Ticket Type: INBOUND INVOICE

Ticket Number: 1798
Date: 10/06/2010
Time In: 12:49 am
Time Out: 1:14 am

Customer: 001011 - NGE, LLC c/o Northgate Environ Mgmt

Vehicle/Container: 44166A
Contract: Northgate Env. On Site Soils 3825 11
Comment: 3825 10 11244

Gross Weight: 139,100 LB Manual In
Tare Weight: 57,260 LB Scale Out
Net Weight: 81840 LB
Net Tons: 40.92

BOL: 11893

Origin	Yards	Material	Billing Quantity
Not Applicable	0.00 YD	SW CONTAMINATED SOIL	40.92 TN

Driver: _____



Weighmaster: _____

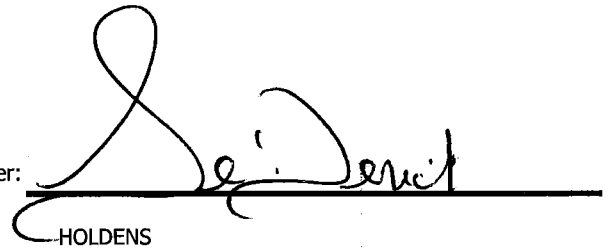

HOLDENS

Indemnification. Customer agrees, by signature above, to indemnify, hold harmless, and defend Republic Services, Inc., its subsidiaries, affiliates, employees, officers and directors from and against any and all liabilities, claims, penalties, forfeitures, suits and the costs and expenses incident thereto, including costs of defense, settlement, and reasonable attorney's fees, which may be incurred, as a result of death or injuries to any person, or damage to any property, contamination of or adverse effects on the environment, caused in whole or in part by the Customer, its employees, or subcontractors in disposing waste at this Facility. In the event Customer delivers Unacceptable Waste (as determined by Republic) Customer agrees to assume all expenses and obligations with the removal and/or resolution of any effects caused by the delivery of such Unacceptable Waste.

Indemnización. Cliente acuerda indemnizar, mantener inmune, y defender Republic Services, Inc., sus subsidiarios, compañías, divisiones, empleados, oficiales y directores contra de cualquiera y de todas responsabilidades, demandas, penas, pérdidas, juicios, pleitos y los costos incidente además, incluyendo costos de defensa, de acuerdo judicial, y de honorarios razonables del abogado, que pueden ser incurridos en, o como resultado de, la muerte o herida personal a cualquier persona, o daños a cualquier característica, propiedad, contaminación de la tierra o efectos ilícitos en esta Facilidad, causado entero o en parte por el cliente, sus empleados, o sus subcontratistas en botar basura en esta Facilidad. En el caso que el Cliente entrega, bota, basura (según lo determinado por Republic) en este Establecimiento basura inaceptable en los reglamentos de este Establecimiento, el Cliente se compromete asumir todos los costos y obligaciones con el retiro y/o la resolución de cualquier dano(s) causado por la entrega de tal basura inaceptable.



NON-HAZARDOUS WASTE MANIFEST

MANIFEST # 11893

GENERATOR INFORMATION

Generator Name: Tronox LLCAddress: P.O. Box 55City: Henderson County: ClarkState: NV Zip: 89009Site Location (if different): 560 W. Lake MeadHenderson, NV 89015 (702) 592-7727

CUSTOMER/BILLING INFORMATION

Billing Name: NGE LLC c/o Northgate Environment ManagementAddress: 300 Frank Ogawa Plaza, Ste 510City: Oakland County: AlamedaState: CA Zip: 94612

Republic Services Approval #	Description of Waste	Volume/Weight	Expiration Date	Container Type
38251011244	Soil for disposal	210 ⁹² / ₅₇	12-31-2011	Tractor with Dump Trailer(s)
	RZ- _____ # _____			

*Attach Additional Sheet if necessary

I hereby certify that the above-described materials are non-hazardous wastes as defined by 40 CFR 261 or any applicable state law. Further, that the above named materials are properly classified, described, packaged, marked and labeled, and are in proper condition for transportation according to the applicable regulations of the Department of Transportation.

Susan Crowley [Signature] _____
 Generator/Authorized Agent Name Signature Date Shipped

TRANSPORTER INFORMATION

Transporter Name: Las Vegas PavingDOT # 191949Address: 4420 S. DecaturTruck Number: K002Las Vegas, NV 89103Phone Number: (702) 353-4355

I certify no hazardous waste or other regulated substance was knowingly introduced to the waste while in my custody. The waste transported in this vehicle is the waste identified above, to the best of my knowledge.

[Signature] [Signature] 10-5-10
 Name of Authorized Agent Signature Date Delivered

DISPOSAL SITE INFORMATION

Site Name: Apex Regional LandfillPhone No. (702) 599-5920Address: 13550 U.S. Hwy 93 Las Vegas, NV

I hereby acknowledge receipt of the above described materials
[Signature] [Signature] 06 Oct 10
 Name (Print or Type) Signature Date Received

81 Environmental Tech
13550 N Highway 93
Las Vegas, NV 89165

Ticket Type: INBOUND INVOICE

Ticket Number: 1799
Date: 10/06/2010
Time In: 12:48 am
Time Out: 1:15 am

Customer: 001011 - NGE, LLC c/o Northgate Environ Mgmt

Vehicle/Container: 86113P
Contract: Northgate Env. On Site Soils 3825 11
Comment: 3825 10 11244

Gross Weight: 131,380 LB Manual In
Tare Weight: 55,440 LB Manual Out
Net Weight: 75,940 LB
Net Tons: 37.97

BOL: 11894

Origin	Yards	Material	Billing Quantity
Not Applicable	0.00 YD	SW CONTAMINATED SOIL	37.97 TN

Driver: _____

J.A.H.

Weighmaster: _____

[Signature]
HOLDENS

Indemnification. Customer agrees, by signature above, to indemnify, hold harmless, and defend Republic Services, Inc., its subsidiaries, affiliates, employees, officers and directors from and against any and all liabilities, claims, penalties, forfeitures, suits and the costs and expenses incident thereto, including costs of defense, settlement, and reasonable attorney's fees, which may be incurred, as a result of death or injuries to any person, or damage to any property, contamination of or adverse effects on the environment, caused in whole or in part by the Customer, its employees, or subcontractors in disposing waste at this Facility. In the event Customer delivers Unacceptable Waste (as determined by Republic) Customer agrees to assume all expenses and obligations with the removal and/or resolution of any effects caused by the delivery of such Unacceptable Waste.

Indemnización. Cliente acuerda indemnizar, mantener immune, y defender Republic Services, Inc., sus subsidiarios, compañías, divisiones, empleados, oficiales y directores contra de cualquiera y de todas responsabilidades, demandas, penas, pérdidas, juicios, pleitos y los costos incidente además, incluyendo costos de defensa, de acuerdo judicial, y de honorarios razonables del abogado, que pueden ser incurridos en, o como resultado de, la muerte o herida personal a cualquier persona, o daños a cualquier característica, propiedad, contaminación de la tierra o efectos ilícitos en esta Facilidad, causado entero o en parte por el cliente, sus empleados, o sus subcontratistas en botar basura en esta Facilidad. En el caso que el Cliente entrega, bota, basura (según lo determinado por Republic) en este Establecimiento basura inaceptable en los reglamentos de este Establecimiento, el Cliente se compromete asumir todos los costos y obligaciones con el retiro y/o la resolución de cualquier dano(s) causado por la entrega de tal basura inaceptable.



NON-HAZARDOUS WASTE MANIFEST

MANIFEST # 11894

GENERATOR INFORMATION

Generator Name: Tronox LLC
Address: P.O. Box 55
City: Henderson County: Clark
State: NV Zip: 89009
Site Location (if different): 560 W. Lake Mead
Henderson, NV 89015 (702) 592-7727

CUSTOMER/BILLING INFORMATION

Billing Name: NGE LLC c/o Northgate Environment Management
Address: 300 Frank Ogawa Plaza, Ste 510
City: Oakland County: Alameda
State: CA Zip: 94612

Table with 5 columns: Republic Services Approval #, Description of Waste, Volume/Weight, Expiration Date, Container Type. Row 1: 38251011244, Soil for disposal, 37 tons, 12-31-2011, Tractor with Dump Trailer(s).

*Attach Additional Sheet if necessary

I hereby certify that the above-described materials are non-hazardous wastes as defined by 40 CFR 261 or any applicable state law. Further, that the above named materials are properly classified, described, packaged, marked and labeled, and are in proper condition for transportation according to the applicable regulations of the Department of Transportation.

Susan Crowley
Generator/Authorized Agent Name

Signature (handwritten)

Date Shipped

TRANSPORTER INFORMATION

Transporter Name: Las Vegas Paving
Address: 4420 S. Decatur
Las Vegas, NV 89103

DOT # 191949
Truck Number: K001917
Phone Number: (702) 353-4355

I certify no hazardous waste or other regulated substance was knowingly introduced to the waste while in my custody. The waste transported in this vehicle is the waste identified above, to the best of my knowledge.

ALBERTO
Name of Authorized Agent

Signature (handwritten)

OCT 5, 2010
Date Delivered

DISPOSAL SITE INFORMATION

Site Name: Apex Regional Landfill
Address: 13550 U.S. Hwy 93 Las Vegas, NV

Phone No. (702) 599-5920

I hereby acknowledge receipt of the above described materials
Name (Print or Type)

Signature (handwritten: Se Derick Holden)

06 Oct 10
Date Received

81 Environmental Tech
13550 N Highway 93
Las Vegas, NV 89165

Ticket Type: INBOUND INVOICE

Ticket Number: 1800
Date: 10/06/2010
Time In: 12:49 am
Time Out: 1:17 am

Customer: 001011 - NGE, LLC c/o Northgate Environ Mgmt

Vehicle/Container: 68263P
Contract: Northgate Env. On Site Soils 3825 11
Comment: 3825 10 11244

Gross Weight: 120,340 LB Manual In
Tare Weight: 53,580 LB Scale Out
Net Weight: 66,760 LB
Net Tons: 33.38

BOL: 11895

Origin	Yards	Material	Billing	Quantity
Not Applicable	0.00 YD	SW CONTAMINATED SOIL	33.38	TN

Driver:



Weighmaster:

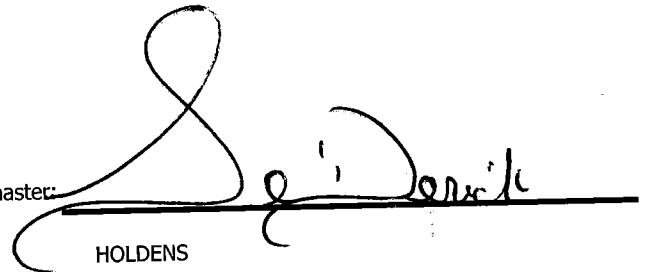

HOLDENS

Indemnification. Customer agrees, by signature above, to indemnify, hold harmless, and defend Republic Services, Inc., its subsidiaries, affiliates, employees, officers and directors from and against any and all liabilities, claims, penalties, forfeitures, suits and the costs and expenses incident thereto, including costs of defense, settlement, and reasonable attorney's fees, which may be incurred, as a result of death or injuries to any person, or damage to any property, contamination of or adverse effects on the environment, caused in whole or in part by the Customer, its employees, or subcontractors in disposing waste at this Facility. In the event Customer delivers Unacceptable Waste (as determined by Republic) Customer agrees to assume all expenses and obligations with the removal and/or resolution of any effects caused by the delivery of such Unacceptable Waste.

Indemnización. Cliente acuerda indemnizar, mantener inmune, y defender Republic Services, Inc., sus subsidiarios, compañías, divisiones, empleados, oficiales y directores contra de cualquiera y de todas responsabilidades, demandas, penas, pérdidas, juicios, pleitos y los costos incidente además, incluyendo costos de defensa, de acuerdo judicial, y de honorarios razonables del abogado, que pueden ser incurridos en, o como resultado de, la muerte o herida personal a cualquier persona, o daños a cualquier característica, propiedad, contaminación de la tierra o efectos ilícitos en esta Facilidad, causado entero o en parte por el cliente, sus empleados, o sus subcontratistas en botar basura en esta Facilidad. En el caso que el Cliente entrega, bota, basura (según lo determinado por Republic) en este Establecimiento basura inaceptable en los reglamentos de este Establecimiento, el Cliente se compromete asumir todos los costos y obligaciones con el retiro y/o la resolución de cualquier dano(s) causado por la entrega de tal basura inaceptable.



NON-HAZARDOUS WASTE MANIFEST

MANIFEST # 11895

GENERATOR INFORMATION

Generator Name: Tronox LLC

Address: P.O. Box 55

City: Henderson County: Clark

State: NV Zip: 89009

Site Location (if different): 560 W. Lake Mead

Henderson, NV 89015 (702) 592-7727

CUSTOMER/BILLING INFORMATION

Billing Name: NGE LLC c/o Northgate Environment Management

Address: 300 Frank Ogawa Plaza, Ste 510

City: Oakland County: Alameda

State: CA Zip: 94612

Republic Services Approval #	Description of Waste	Volume/Weight	Expiration Date	Container Type
38251011244	Soil for disposal	33 ³⁸ / _{ton}	12-31-2011	Tractor with Dump Trailer(s)
	RZ- #			

*Attach Additional Sheet if necessary

I hereby certify that the above-described materials are non-hazardous wastes as defined by 40 CFR 261 or any applicable state law. Further, that the above named materials are properly classified, described, packaged, marked and labeled, and are in proper condition for transportation according to the applicable regulations of the Department of Transportation.

Susan Crowley *Susan Crowley*
 Generator/Authorized Agent Name Signature Date Shipped

TRANSPORTER INFORMATION

Transporter Name: Las Vegas Paving

DOT # 191949

Address: 4420 S. Decatur

Truck Number: 2711

Las Vegas, NV 89103

Phone Number: (702) 353-4355

I certify no hazardous waste or other regulated substance was knowingly introduced to the waste while in my custody. The waste transported in this vehicle is the waste identified above, to the best of my knowledge.

STEVE HAYES *Steve Hayes* 10-5-10
 Name of Authorized Agent Signature Date Delivered

DISPOSAL SITE INFORMATION

Site Name: Apex Regional Landfill

Phone No. (702) 599-5920

Address: 13550 U.S. Hwy 93 Las Vegas, NV

I hereby acknowledge receipt of the above described materials
Holden, Seider *Sei David Holden* 06 Oct 10
 Name (Print or Type) Signature Date Received

81 Environmental Tech
13550 N Highway 93
Las Vegas, NV 89165

Ticket Type: INBOUND INVOICE

Ticket Number: 1801
Date: 10/06/2010
Time In: 12:53 am
Time Out: 1:20 am

Customer: 001011 - NGE, LLC c/o Northgate Environ Mgmt

Vehicle/Container: 81460P
Contract: Northgate Env. On Site Soils 3825 11
Comment: 3825 10 11244

Gross Weight: 122,440 LB Manual In
Tare Weight: 53,060 LB Manual Out
Net Weight: 69380 LB
Net Tons: 34.69

BOL: 11896

Origin	Yards	Material	Billing Quantity
Not Applicable	0.00 YD	SW CONTAMINATED SOIL	34.69 TN

Driver: _____

Weighmaster: _____

HOLDENS

Indemnification. Customer agrees, by signature above, to indemnify, hold harmless, and defend Republic Services, Inc., its subsidiaries, affiliates, employees, officers and directors from and against any and all liabilities, claims, penalties, forfeitures, suits and the costs and expenses incident thereto, including costs of defense, settlement, and reasonable attorney's fees, which may be incurred, as a result of death or injuries to any person, or damage to any property, contamination of or adverse effects on the environment, caused in whole or in part by the Customer, its employees, or subcontractors in disposing waste at this Facility. In the event Customer delivers Unacceptable Waste (as determined by Republic) Customer agrees to assume all expenses and obligations with the removal and/or resolution of any effects caused by the delivery of such Unacceptable Waste.

Indemnización. Cliente acuerda indemnizar, mantener immune, y defender Republic Services, Inc., sus subsidiarios, compañías, divisiones, empleados, oficiales y directores contra de cualquiera y de todas responsabilidades, demandas, penas, pérdidas, juicios, pleitos y los costos incidente además, incluyendo costos de defensa, de acuerdo judicial, y de honorarios razonables del abogado, que pueden ser incurridos en, o como resultado de, la muerte o herida personal a cualquier persona, o daños a cualquier característica, propiedad, contaminación de la tierra o efectos ilícitos en esta Facilidad, causado entero o en parte por el cliente, sus empleados, o sus subcontratistas en botar basura en esta Facilidad. En el caso que el Cliente entrega, bota, basura (según lo determinado por Republic) en este Establecimiento basura inaceptable en los reglamentos de este Establecimiento, el Cliente se compromete asumir todos los costos y obligaciones con el retiro y/o la resolución de cualquier dano(s) causado por la entrega de tal basura inaceptable.



NON-HAZARDOUS WASTE MANIFEST

MANIFEST # 11896

GENERATOR INFORMATION

Generator Name: Tronox LLC

Address: P.O. Box 55

City: Henderson County: Clark

State: NV Zip: 89009

Site Location (if different): 560 W. Lake Mead

Henderson, NV 89015 (702) 592-7727

CUSTOMER/BILLING INFORMATION

Billing Name: NGE LLC c/o Northgate Environment Management

Address: 300 Frank Ogawa Plaza, Ste 510

City: Oakland County: Alameda

State: CA Zip: 94612

Table with 5 columns: Republic Services Approval #, Description of Waste, Volume/Weight, Expiration Date, Container Type. Row 1: 38251011244, Soil for disposal, 34 tons, 12-31-2011, Tractor with Dump Trailer(s). Row 2: RZ- #

*Attach Additional Sheet if necessary

I hereby certify that the above-described materials are non-hazardous wastes as defined by 40 CFR 261 or any applicable state law. Further, that the above named materials are properly classified, described, packaged, marked and labeled, and are in proper condition for transportation according to the applicable regulations of the Department of Transportation.

Susan Crowley (Signature) Generator/Authorized Agent Name Date Shipped

TRANSPORTER INFORMATION

Transporter Name: Las Vegas Paving

DOT # 191949

Address: 4420 S. Decatur

Truck Number: 27

Las Vegas, NV 89103

Phone Number: (702) 353-4355

I certify no hazardous waste or other regulated substance was knowingly introduced to the waste while in my custody. The waste transported in this vehicle is the waste identified above, to the best of my knowledge.

Daniel Candinas (Signature) Name of Authorized Agent Date Delivered 10-5-2010

DISPOSAL SITE INFORMATION

Site Name: Apex Regional Landfill

Phone No. (702) 599-5920

Address: 13550 U.S. Hwy 93 Las Vegas, NV

I hereby acknowledge receipt of the above described materials

Holden Se' Derick (Signature) Name (Print or Type) Date Received 06 Oct 10

81 Environmental Tech
13550 N Highway 93
Las Vegas, NV 89165

Ticket Type: INBOUND INVOICE

Ticket Number: 1802
Date: 10/06/2010
Time In: 1:04 am
Time Out: 1:25 am

Customer: 001011 - NGE, LLC c/o Northgate Environ Mgmt

Vehicle/Container: 44564A
Contract: Northgate Env. On Site Soils 3825 11
Comment: 3825 10 11244

Gross Weight: 124,940 LB Manual In
Tare Weight: 49,140 LB Scale Out
Net Weight: 75800 LB
Net Tons: 37.90

BOL: 11897

Origin	Yards	Material	Billing	Quantity
Not Applicable	0.00 YD	SW CONTAMINATED SOIL	37.90	TN

Driver:

Weighmaster:

HOLDENS

Indemnification. Customer agrees, by signature above, to indemnify, hold harmless, and defend Republic Services, Inc., its subsidiaries, affiliates, employees, officers and directors from and against any and all liabilities, claims, penalties, forfeitures, suits and the costs and expenses incident thereto, including costs of defense, settlement, and reasonable attorney's fees, which may be incurred, as a result of death or injuries to any person, or damage to any property, contamination of or adverse effects on the environment, caused in whole or in part by the Customer, its employees, or subcontractors in disposing waste at this Facility. In the event Customer delivers Unacceptable Waste (as determined by Republic) Customer agrees to assume all expenses and obligations with the removal and/or resolution of any effects caused by the delivery of such Unacceptable Waste.

Indemnización. Cliente acuerda indemnizar, mantener inmune, y defender Republic Services, Inc., sus subsidiarios, compañías, divisiones, empleados, oficiales y directores contra de cualquiera y de todas responsabilidades, demandas, penas, pérdidas, juicios, pleitos y los costos incidente además, incluyendo costos de defensa, de acuerdo judicial, y de honorarios razonables del abogado, que pueden ser incurridos en, o como resultado de, la muerte o herida personal a cualquier persona, o daños a cualquier característica, propiedad, contaminación de la tierra o efectos ilícitos en esta Facilidad, causado entero o en parte por el cliente, sus empleados, o sus subcontratistas en botar basura en esta Facilidad. En el caso que el Cliente entrega, bota, basura (según lo determinado por Republic) en este Establecimiento basura inaceptable en los reglamentos de este Establecimiento, el Cliente se compromete asumir todos los costos y obligaciones con el retiro y/o la resolución de cualquier dano(s) causado por la entrega de tal basura inaceptable.



NON-HAZARDOUS WASTE MANIFEST

MANIFEST # 11897

GENERATOR INFORMATION

Generator Name: Tronox LLC
Address: P.O. Box 55
City: Henderson County: Clark
State: NV Zip: 89009
Site Location (if different): 560 W. Lake Mead
Henderson, NV 89015 (702) 592-7727

CUSTOMER/BILLING INFORMATION

Billing Name: NGE LLC c/o Northgate Environment Management
Address: 300 Frank Ogawa Plaza, Ste 510
City: Oakland County: Alameda
State: CA Zip: 94612

Table with 5 columns: Republic Services Approval #, Description of Waste, Volume/Weight, Expiration Date, Container Type. Row 1: 38251011244, Soil for disposal, 37.90, 12-31-2011, Tractor with Dump Trailer(s).

*Attach Additional Sheet if necessary

I hereby certify that the above-described materials are non-hazardous wastes as defined by 40 CFR 261 or any applicable state law. Further, that the above named materials are properly classified, described, packaged, marked and labeled, and are in proper condition for transportation according to the applicable regulations of the Department of Transportation.

Susan Crowley
Generator/Authorized Agent Name Signature Date Shipped

TRANSPORTER INFORMATION

Transporter Name: Las Vegas Paving DOT # 191949
Address: 4420 S. Decatur Truck Number: 1003
Las Vegas, NV 89103 Phone Number: (702) 353-4355

I certify no hazardous waste or other regulated substance was knowingly introduced to the waste while in my custody. The waste transported in this vehicle is the waste identified above, to the best of my knowledge.

CEBU CEBU 10/05/10
Name of Authorized Agent Signature Date Delivered

DISPOSAL SITE INFORMATION

Site Name: Apex Regional Landfill Phone No. (702) 599-5920
Address: 13550 U.S. Hwy 93 Las Vegas, NV

I hereby acknowledge receipt of the above described materials
Holden, Se'Derck Signature Date Received 06 Oct 10

81 Environmental Tech
13550 N Highway 93
Las Vegas, NV 89165

Ticket Type: INBOUND INVOICE

Ticket Number: 1803
Date: 10/06/2010
Time In: 1:15 am
Time Out: 1:40 am

Customer: 001011 - NGE, LLC c/o Northgate Environ Mgmt

Vehicle/Container: 85887P
Contract: Northgate Env. On Site Soils 3825 11
Comment: 3825 10 11244

Gross Weight: 126,040 LB Manual In
Tare Weight: 50,280 LB Scale Out
Net Weight: 75760 LB
Net Tons: 37.88

BOL: 11898

Origin	Yards	Material	Billing	Quantity
Not Applicable	0.00 YD	SW CONTAMINATED SOIL	37.88	TN

Driver: Miguel R.

Weighmaster: [Signature]

HOLDENS

Indemnification. Customer agrees, by signature above, to indemnify, hold harmless, and defend Republic Services, Inc., its subsidiaries, affiliates, employees, officers and directors from and against any and all liabilities, claims, penalties, forfeitures, suits and the costs and expenses incident thereto, including costs of defense, settlement, and reasonable attorney's fees, which may be incurred, as a result of death or injuries to any person, or damage to any property, contamination of or adverse effects on the environment, caused in whole or in part by the Customer, its employees, or subcontractors in disposing waste at this Facility. In the event Customer delivers Unacceptable Waste (as determined by Republic) Customer agrees to assume all expenses and obligations with the removal and/or resolution of any effects caused by the delivery of such Unacceptable Waste.

Indemnización. Cliente acuerda indemnizar, mantener inmune, y defender Republic Services, Inc., sus subsidiarios, compañías, divisiones, empleados, oficiales y directores contra de cualquiera y de todas responsabilidades, demandas, penas, pérdidas, juicios, pleitos y los costos incidente además, incluyendo costos de defensa, de acuerdo judicial, y de honorarios razonables del abogado, que pueden ser incurridos en, o como resultado de, la muerte o herida personal a cualquier persona, o daños a cualquier característica, propiedad, contaminación de la tierra o efectos ilícitos en esta Facilidad, causado entero o en parte por el cliente, sus empleados, o sus subcontratistas en botar basura en esta Facilidad. En el caso que el Cliente entrega, bota, basura (según lo determinado por Republic) en este Establecimiento basura inaceptable en los reglamentos de este Establecimiento, el Cliente se compromete asumir todos los costos y obligaciones con el retiro y/o la resolución de cualquier dano(s) causado por la entrega de tal basura inaceptable.



NON-HAZARDOUS WASTE MANIFEST

MANIFEST # 11898

GENERATOR INFORMATION

Generator Name: Tronox LLC

Address: P.O. Box 55

City: Henderson County: Clark

State: NV Zip: 89009

Site Location (if different): 560 W. Lake Mead

Henderson, NV 89015 (702) 592-7727

CUSTOMER/BILLING INFORMATION

Billing Name: NGE LLC c/o Northgate Environment Management

Address: 300 Frank Ogawa Plaza, Ste 510

City: Oakland County: Alameda

State: CA Zip: 94612

Table with 5 columns: Republic Services Approval #, Description of Waste, Volume/Weight, Expiration Date, Container Type. Row 1: 38251011244, Soil for disposal, 37 23/100, 12-31-2011, Tractor with Dump Trailer(s).

*Attach Additional Sheet if necessary

I hereby certify that the above-described materials are non-hazardous wastes as defined by 40 CFR 261 or any applicable state law. Further, that the above named materials are properly classified, described, packaged, marked and labeled, and are in proper condition for transportation according to the applicable regulations of the Department of Transportation.

Susan Crowley (Name), [Signature] (Signature), Date Shipped

TRANSPORTER INFORMATION

Transporter Name: Las Vegas Paving

DOT # 191949

Address: 4420 S. Decatur

Truck Number: R01

Las Vegas, NV 89103

Phone Number: (702) 353-4355

I certify no hazardous waste or other regulated substance was knowingly introduced to the waste while in my custody. The waste transported in this vehicle is the waste identified above, to the best of my knowledge.

Miguel (Name), [Signature] (Signature), 10-5-2010 (Date Delivered)

DISPOSAL SITE INFORMATION

Site Name: Apex Regional Landfill

Phone No: (702) 599-5920

Address: 13550 U.S. Hwy 93 Las Vegas, NV

I hereby acknowledge receipt of the above described materials

Holden, S. [Signature] (Signature), 06 Oct 10 (Date Received)

81 Environmental Tech
13550 N Highway 93
Las Vegas, NV 89165

Ticket Type: INBOUND INVOICE

Ticket Number: 1804
Date: 10/06/2010
Time In: 1:45 am
Time Out: 2:08 am

Customer: 001011 - NGE, LLC c/o Northgate Environ Mgmt

Vehicle/Container: 192457
Contract: Northgate Env. On Site Soils 3825 11
Comment: 3825 10 11244

Gross Weight: 124,420 LB Manual In
Tare Weight: 52,040 LB Manual Out
Net Weight: 72380 LB
Net Tons: 36.19

BOL: 11899

Origin	Yards	Material	Billing Quantity
Not Applicable	0.00 YD	SW CONTAMINATED SOIL	36.19 TN

Driver: 

Weighmaster: 

HOLDENS

Indemnification. Customer agrees, by signature above, to indemnify, hold harmless, and defend Republic Services, Inc., its subsidiaries, affiliates, employees, officers and directors from and against any and all liabilities, claims, penalties, forfeitures, suits and the costs and expenses incident thereto, including costs of defense, settlement, and reasonable attorney's fees, which may be incurred, as a result of death or injuries to any person, or damage to any property, contamination of or adverse effects on the environment, caused in whole or in part by the Customer, its employees, or subcontractors in disposing waste at this Facility. In the event Customer delivers Unacceptable Waste (as determined by Republic) Customer agrees to assume all expenses and obligations with the removal and/or resolution of any effects caused by the delivery of such Unacceptable Waste.

Indemnización. Cliente acuerda indemnizar, mantener inmune, y defender Republic Services, Inc., sus subsidiarios, compañías, divisiones, empleados, oficiales y directores contra de cualquiera y de todas responsabilidades, demandas, penas, pérdidas, juicios, pleitos y los costos incidente además, incluyendo costos de defensa, de acuerdo judicial, y de honorarios razonables del abogado, que pueden ser incurridos en, o como resultado de, la muerte o herida personal a cualquier persona, o daños a cualquier característica, propiedad, contaminación de la tierra o efectos ilícitos en esta Facilidad, causado entero o en parte por el cliente, sus empleados, o sus subcontratistas en botar basura en esta Facilidad. En el caso que el Cliente entrega, bota, basura (según lo determinado por Republic) en este Establecimiento basura inaceptable en los reglamentos de este Establecimiento, el Cliente se compromete asumir todos los costos y obligaciones con el retiro y/o la resolución de cualquier dano(s) causado por la entrega de tal basura inaceptable.



NON-HAZARDOUS WASTE MANIFEST

MANIFEST # 11899

GENERATOR INFORMATION

Generator Name: Tronox LLC
Address: P.O. Box 55
City: Henderson County: Clark
State: NV Zip: 89009
Site Location (if different): 560 W. Lake Mead
Henderson, NV 89015 (702) 592-7727

CUSTOMER/BILLING INFORMATION

Billing Name: NGE LLC c/o Northgate Environment Management
Address: 300 Frank Ogawa Plaza, Ste 510
City: Oakland County: Alameda
State: CA Zip: 94612

Table with 5 columns: Republic Services Approval #, Description of Waste, Volume/Weight, Expiration Date, Container Type. Row 1: 38251011244, Soil for disposal, 36 19/100, 12-31-2011, Tractor with Dump Trailer(s).

*Attach Additional Sheet if necessary

I hereby certify that the above-described materials are non-hazardous wastes as defined by 40 CFR 261 or any applicable state law. Further, that the above named materials are properly classified, described, packaged, marked and labeled, and are in proper condition for transportation according to the applicable regulations of the Department of Transportation.

Susan Crowley
Generator/Authorized Agent Name Signature Date Shipped

TRANSPORTER INFORMATION

Transporter Name: Las Vegas Paving DOT # 191949
Address: 4420 S. Decatur Truck Number: 192457
Las Vegas, NV 89103 Phone Number: (702) 353-4355

I certify no hazardous waste or other regulated substance was knowingly introduced to the waste while in my custody. The waste transported in this vehicle is the waste identified above, to the best of my knowledge.

Brian Binkemoff
Name of Authorized Agent Signature Date Delivered 10-5-10

DISPOSAL SITE INFORMATION

Site Name: Apex Regional Landfill Phone No. (702) 599-5920
Address: 13550 U.S. Hwy 93 Las Vegas, NV

I hereby acknowledge receipt of the above described materials
Name (Print or Type) Signature Date Received 06 Oct 10

81 Environmental Tech
13550 N Highway 93
Las Vegas, NV 89165

Ticket Type: INBOUND INVOICE

Ticket Number: 1805
Date: 10/06/2010
Time In: 1:46 am
Time Out: 2:11 am

Customer: 001011 - NGE, LLC c/o Northgate Environ Mgmt

Vehicle/Container: 192456
Contract: Northgate Env. On Site Soils 3825 11
Comment: 3825 10 11244

Gross Weight: 124,580 LB Manual In
Tare Weight: 52,760 LB Scale Out
Net Weight: 71,820 LB
Net Tons: 35.91

BOL: 11900

Origin	Yards	Material	Billing Quantity
Not Applicable	0.00 YD	SW CONTAMINATED SOIL	35.91 TN

Driver: _____

Weighmaster: _____

HOLDENS

Indemnification. Customer agrees, by signature above, to indemnify, hold harmless, and defend Republic Services, Inc., its subsidiaries, affiliates, employees, officers and directors from and against any and all liabilities, claims, penalties, forfeitures, suits and the costs and expenses incident thereto, including costs of defense, settlement, and reasonable attorney's fees, which may be incurred, as a result of death or injuries to any person, or damage to any property, contamination of or adverse effects on the environment, caused in whole or in part by the Customer, its employees, or subcontractors in disposing waste at this Facility. In the event Customer delivers Unacceptable Waste (as determined by Republic) Customer agrees to assume all expenses and obligations with the removal and/or resolution of any effects caused by the delivery of such Unacceptable Waste.

Indemnización. Cliente acuerda indemnizar, mantener inmune, y defender Republic Services, Inc., sus subsidiarios, compañías, divisiones, empleados, oficiales y directores contra de cualquiera y de todas responsabilidades, demandas, penas, pérdidas, juicios, pleitos y los costos incidente además, incluyendo costos de defensa, de acuerdo judicial, y de honorarios razonables del abogado, que pueden ser incurridos en, o como resultado de, la muerte o herida personal a cualquier persona, o daños a cualquier característica, propiedad, contaminación de la tierra o efectos ilícitos en esta Facilidad, causado entero o en parte por el cliente, sus empleados, o sus subcontratistas en botar basura en esta Facilidad. En el caso que el Cliente entrega, bota, basura (según lo determinado por Republic) en este Establecimiento basura inaceptable en los reglamentos de este Establecimiento, el Cliente se compromete asumir todos los costos y obligaciones con el retiro y/o la resolución de cualquier dano(s) causado por la entrega de tal basura inaceptable.



NON-HAZARDOUS WASTE MANIFEST

MANIFEST # 11900

GENERATOR INFORMATION

Generator Name: Tronox LLC
Address: P.O. Box 55
City: Henderson County: Clark
State: NV Zip: 89009
Site Location (if different): 560 W. Lake Mead
Henderson, NV 89015 (702) 592-7727

CUSTOMER/BILLING INFORMATION

Billing Name: NGE LLC c/o Northgate Environment Management
Address: 300 Frank Ogawa Plaza, Ste 510
City: Oakland County: Alameda
State: CA Zip: 94612

Table with 5 columns: Republic Services Approval #, Description of Waste, Volume/Weight, Expiration Date, Container Type. Row 1: 38251011244, Soil for disposal, 35 9/10, 12-31-2011, Tractor with Dump Trailer(s).

*Attach Additional Sheet if necessary

I hereby certify that the above-described materials are non-hazardous wastes as defined by 40 CFR 261 or any applicable state law. Further, that the above named materials are properly classified, described, packaged, marked and labeled, and are in proper condition for transportation according to the applicable regulations of the Department of Transportation.

Susan Crowley
Generator/Authorized Agent Name Signature Date Shipped

TRANSPORTER INFORMATION

Transporter Name: Las Vegas Paving DOT # 191949
Address: 4420 S. Decatur Truck Number: 192456
Las Vegas, NV 89103 Phone Number: (702) 353-4355

I certify no hazardous waste or other regulated substance was knowingly introduced to the waste while in my custody. The waste transported in this vehicle is the waste identified above, to the best of my knowledge.

Name of Authorized Agent Signature Date Delivered

DISPOSAL SITE INFORMATION

Site Name: Apex Regional Landfill Phone No. (702) 599-5920
Address: 13550 U.S. Hwy 93 Las Vegas, NV

I hereby acknowledge receipt of the above described materials
Name (Print or Type) Signature Date Received

81 Environmental Tech
13550 N Highway 93
Las Vegas, NV 89165

Ticket Type: INBOUND INVOICE

Ticket Number: 1806
Date: 10/06/2010
Time In: 1:47 am
Time Out: 2:12 am

Customer: 001011 - NGE, LLC c/o Northgate Environ Mgmt

Vehicle/Container: 192460
Contract: Northgate Env. On Site Soils 3825 11
Comment: 3825 10 11244

Gross Weight: 125,020 LB Manual In
Tare Weight: 53,100 LB Manual Out
Net Weight: 71920 LB
Net Tons: 35.96

BOL: 11901

Origin	Yards	Material	Billing	Quantity
Not Applicable	0.00 YD	SW CONTAMINATED SOIL	35.96	TN

Driver:

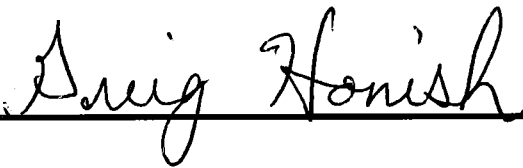

Weighmaster:

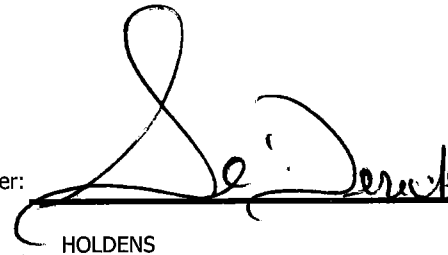
HOLDENS

Indemnification. Customer agrees, by signature above, to indemnify, hold harmless, and defend Republic Services, Inc., its subsidiaries, affiliates, employees, officers and directors from and against any and all liabilities, claims, penalties, forfeitures, suits and the costs and expenses incident thereto, including costs of defense, settlement, and reasonable attorney's fees, which may be incurred, as a result of death or injuries to any person, or damage to any property, contamination of or adverse effects on the environment, caused in whole or in part by the Customer, its employees, or subcontractors in disposing waste at this Facility. In the event Customer delivers Unacceptable Waste (as determined by Republic) Customer agrees to assume all expenses and obligations with the removal and/or resolution of any effects caused by the delivery of such Unacceptable Waste.

Indemnización. Cliente acuerda indemnizar, mantener inmune, y defender Republic Services, Inc., sus subsidiarios, compañías, divisiones, empleados, oficiales y directores contra de cualquiera y de todas responsabilidades, demandas, penas, pérdidas, juicios, pleitos y los costos incidente además, incluyendo costos de defensa, de acuerdo judicial, y de honorarios razonables del abogado, que pueden ser incurridos en, o como resultado de, la muerte o herida personal a cualquier persona, o daños a cualquier característica, propiedad, contaminación de la tierra o efectos ilícitos en esta Facilidad, causado entero o en parte por el cliente, sus empleados, o sus subcontratistas en botar basura en esta Facilidad. En el caso que el Cliente entrega, bota, basura (según lo determinado por Republic) en este Establecimiento basura inaceptable en los reglamentos de este Establecimiento, el Cliente se compromete asumir todos los costos y obligaciones con el retiro y/o la resolución de cualquier dano(s) causado por la entrega de tal basura inaceptable.



NON-HAZARDOUS WASTE MANIFEST

MANIFEST # 11901

GENERATOR INFORMATION

Generator Name: Tronox LLC
Address: P.O. Box 55
City: Henderson County: Clark
State: NV Zip: 89009
Site Location (if different): 560 W. Lake Mead
Henderson, NV 89015 (702) 592-7727

CUSTOMER/BILLING INFORMATION

Billing Name: NGE LLC c/o Northgate Environment Management
Address: 300 Frank Ogawa Plaza, Ste 510
City: Oakland County: Alameda
State: CA Zip: 94612

Table with 5 columns: Republic Services Approval #, Description of Waste, Volume/Weight, Expiration Date, Container Type. Row 1: 38251011244, Soil for disposal, 35 96/100 Ton, 12-31-2011, Tractor with Dump Trailer(s).

*Attach Additional Sheet if necessary

I hereby certify that the above-described materials are non-hazardous wastes as defined by 40 CFR 261 or any applicable state law. Further, that the above named materials are properly classified, described, packaged, marked and labeled, and are in proper condition for transportation according to the applicable regulations of the Department of Transportation.

Susan Crowley (Signature)
Generator/Authorized Agent Name Signature Date Shipped

TRANSPORTER INFORMATION

Transporter Name: Las Vegas Paving DOT # 191949
Address: 4420 S. Decatur Truck Number: 2460
Las Vegas, NV 89103 Phone Number: (702) 353-4355

I certify no hazardous waste or other regulated substance was knowingly introduced to the waste while in my custody. The waste transported in this vehicle is the waste identified above, to the best of my knowledge.

Graig Honish (Signature)
Name of Authorized Agent Signature Date Delivered 10-5-10

DISPOSAL SITE INFORMATION

Site Name: Apex Regional Landfill Phone No. (702) 599-5920
Address: 13550 U.S. Hwy 93 Las Vegas, NV

I hereby acknowledge receipt of the above described materials
Abdullah Seiback (Signature)
Name (Print or Type) Signature Date Received 06 Oct 10

81 Environmental Tech
13550 N Highway 93
Las Vegas, NV 89165

Ticket Type: INBOUND INVOICE

Ticket Number: 1807
Date: 10/06/2010
Time In: 1:52 am
Time Out: 2:15 am

Customer: 001011 - NGE, LLC c/o Northgate Environ Mgmt

Vehicle/Container: 35903A
Contract: Northgate Env. On Site Soils 3825 11
Comment: 3825 10 11244

Gross Weight: 123,320 LB Manual In
Tare Weight: 58,320 LB Scale Out
Net Weight: 65000 LB
Net Tons: 32.50

BOL: 11902

Origin	Yards	Material	Billing	Quantity
Not Applicable	0.00 YD	SW CONTAMINATED SOIL	32.50	TN

Driver:

JAY MASON

Weighmaster:

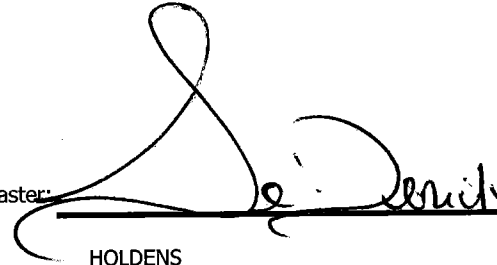

HOLDENS

Indemnification. Customer agrees, by signature above, to indemnify, hold harmless, and defend Republic Services, Inc., its subsidiaries, affiliates, employees, officers and directors from and against any and all liabilities, claims, penalties, forfeitures, suits and the costs and expenses incident thereto, including costs of defense, settlement, and reasonable attorney's fees, which may be incurred, as a result of death or injuries to any person, or damage to any property, contamination of or adverse effects on the environment, caused in whole or in part by the Customer, its employees, or subcontractors in disposing waste at this Facility. In the event Customer delivers Unacceptable Waste (as determined by Republic) Customer agrees to assume all expenses and obligations with the removal and/or resolution of any effects caused by the delivery of such Unacceptable Waste.

Indemnización. Cliente acuerda indemnizar, mantener inmune, y defender Republic Services, Inc., sus subsidiarios, compañías, divisiones, empleados, oficiales y directores contra de cualquiera y de todas responsabilidades, demandas, penas, pérdidas, juicios, pleitos y los costos incidente además, incluyendo costos de defensa, de acuerdo judicial, y de honorarios razonables del abogado, que pueden ser incurridos en, o como resultado de, la muerte o herida personal a cualquier persona, o daños a cualquier característica, propiedad, contaminación de la tierra o efectos ilícitos en esta Facilidad, causado entero o en parte por el cliente, sus empleados, o sus subcontratistas en botar basura en esta Facilidad. En el caso que el Cliente entrega, bota, basura (según lo determinado por Republic) en este Establecimiento basura inaceptable en los reglamentos de este Establecimiento, el Cliente se compromete asumir todos los costos y obligaciones con el retiro y/o la resolución de cualquier dano(s) causado por la entrega de tal basura inaceptable.



NON-HAZARDOUS WASTE MANIFEST

MANIFEST # 11902

GENERATOR INFORMATION

Generator Name: Tronox LLC

Address: P.O. Box 55

City: Henderson County: Clark

State: NV Zip: 89009

Site Location (if different): 560 W. Lake Mead

Henderson, NV 89015 (702) 592-7727

CUSTOMER/BILLING INFORMATION

Billing Name: NGE LLC c/o Northgate Environment Management

Address: 300 Frank Ogawa Plaza, Ste 510

City: Oakland County: Alameda

State: CA Zip: 94612

Table with 5 columns: Republic Services Approval #, Description of Waste, Volume/Weight, Expiration Date, Container Type. Row 1: 38251011244, Soil for disposal, 32 50/ton, 12-31-2011, Tractor with Dump Trailer(s). Row 2: RZ- #

*Attach Additional Sheet if necessary

I hereby certify that the above-described materials are non-hazardous wastes as defined by 40 CFR 261 or any applicable state law. Further, that the above named materials are properly classified, described, packaged, marked and labeled, and are in proper condition for transportation according to the applicable regulations of the Department of Transportation.

Susan Crowley (Signature) Generator/Authorized Agent Name Date Shipped

TRANSPORTER INFORMATION

Transporter Name: Las Vegas Paving

DOT # 191949

Address: 4420 S. Decatur

Truck Number: 07

Las Vegas, NV 89103

Phone Number: (702) 353-4355

I certify no hazardous waste or other regulated substance was knowingly introduced to the waste while in my custody. The waste transported in this vehicle is the waste identified above, to the best of my knowledge.

Wardco BC (Signature) JAY MASON (Signature) 10-6-10 (Date) Name of Authorized Agent Signature Date Delivered

DISPOSAL SITE INFORMATION

Site Name: Apex Regional Landfill

Phone No. (702) 599-5920

Address: 13550 U.S. Hwy 93 Las Vegas, NV

I hereby acknowledge receipt of the above described materials

Holsten So Jench (Signature) Date Received

81 Environmental Tech
13550 N Highway 93
Las Vegas, NV 89165

Ticket Type: INBOUND INVOICE

Ticket Number: 1808
Date: 10/06/2010
Time In: 2:01 am
Time Out: 2:23 am

Customer: 001011 - NGE, LLC c/o Northgate Environ Mgmt

Vehicle/Container: 81494P
Contract: Northgate Env. On Site Soils 3825 11
Comment: 3825 10 11244

Gross Weight: 118,800 LB Manual In
Tare Weight: 51,140 LB Manual Out
Net Weight: 67660 LB
Net Tons: 33.83

BOL: 11904

Origin	Yards	Material	Billing	Quantity
Not Applicable	0.00 YD	SW CONTAMINATED SOIL	33.83	TN

Driver: _____



Weighmaster: _____

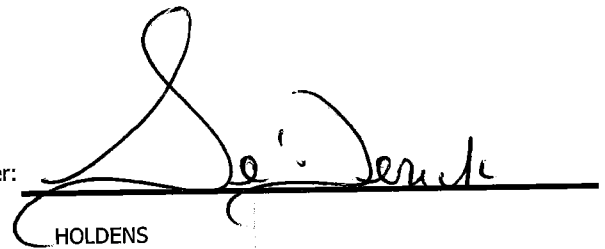

HOLDENS

Indemnification. Customer agrees, by signature above, to indemnify, hold harmless, and defend Republic Services, Inc., its subsidiaries, affiliates, employees, officers and directors from and against any and all liabilities, claims, penalties, forfeitures, suits and the costs and expenses incident thereto, including costs of defense, settlement, and reasonable attorney's fees, which may be incurred, as a result of death or injuries to any person, or damage to any property, contamination of or adverse effects on the environment, caused in whole or in part by the Customer, its employees, or subcontractors in disposing waste at this Facility. In the event Customer delivers Unacceptable Waste (as determined by Republic) Customer agrees to assume all expenses and obligations with the removal and/or resolution of any effects caused by the delivery of such Unacceptable Waste.

Indemnización. Cliente acuerda indemnizar, mantener inmune, y defender Republic Services, Inc., sus subsidiarios, compañías, divisiones, empleados, oficiales y directores contra de cualquiera y de todas responsabilidades, demandas, penas, pérdidas, juicios, pleitos y los costos incidente además, incluyendo costos de defensa, de acuerdo judicial, y de honorarios razonables del abogado, que pueden ser incurridos en, o como resultado de, la muerte o herida personal a cualquier persona, o daños a cualquier característica, propiedad, contaminación de la tierra o efectos ilícitos en esta Facilidad, causado entero o en parte por el cliente, sus empleados, o sus subcontratistas en botar basura en esta Facilidad. En el caso que el Cliente entrega, bota, basura (según lo determinado por Republic) en este Establecimiento basura inaceptable en los reglamentos de este Establecimiento, el Cliente se compromete asumir todos los costos y obligaciones con el retiro y/o la resolución de cualquier dano(s) causado por la entrega de tal basura inaceptable.



NON-HAZARDOUS WASTE MANIFEST

MANIFEST # 11904

GENERATOR INFORMATION

Generator Name: Tronox LLC

Address: P.O. Box 55

City: Henderson County: Clark

State: NV Zip: 89009

Site Location (if different): 560 W. Lake Mead

Henderson, NV 89015 (702) 592-7727

CUSTOMER/BILLING INFORMATION

Billing Name: NGE LLC c/o Northgate Environment Management

Address: 300 Frank Ogawa Plaza, Ste 510

City: Oakland County: Alameda

State: CA Zip: 94612

Republic Services Approval #	Description of Waste	Volume/Weight	Expiration Date	Container Type
38251011244	Soil for disposal	33 ⁸³ / ₁₀₀	12-31-2011	Tractor with Dump Trailer(s)
	RZ- #			

*Attach Additional Sheet if necessary

I hereby certify that the above-described materials are non-hazardous wastes as defined by 40 CFR 261 or any applicable state law. Further, that the above named materials are properly classified, described, packaged, marked and labeled, and are in proper condition for transportation according to the applicable regulations of the Department of Transportation.

Susan Crowley

Susan Crowley

Generator/Authorized Agent Name

Signature

Date Shipped

TRANSPORTER INFORMATION

Transporter Name: Las Vegas Paving

DOT # 191949

Address: 4420 S. Decatur

Truck Number: 125

Las Vegas, NV 89103

Phone Number: (702) 353-4355

I certify no hazardous waste or other regulated substance was knowingly introduced to the waste while in my custody. The waste transported in this vehicle is the waste identified above, to the best of my knowledge.

Calvin Raygo

Calvin Raygo

10-05-10

Name of Authorized Agent

Signature

Date Delivered

DISPOSAL SITE INFORMATION

Site Name: Apex Regional Landfill

Phone No. (702) 599-5920

Address: 13550 U.S. Hwy 93 Las Vegas, NV

I hereby acknowledge receipt of the above described materials

Holden Se Dreck

Holden Se Dreck

06 Oct 10

Name (Print or Type)

Signature

Date Received

81 Environmental Tech
13550 N Highway 93
Las Vegas, NV 89165

Ticket Type: INBOUND INVOICE

Ticket Number: 1809
Date: 10/06/2010
Time In: 2:03 am
Time Out: 2:23 am

Customer: 001011 - NGE, LLC c/o Northgate Environ Mgmt

Vehicle/Container: 86053P
Contract: Northgate Env. On Site Soils 3825 11
Comment: 3825 10 11244

Gross Weight: 125,940 LB Manual In
Tare Weight: 55,720 LB Manual Out
Net Weight: 70220 LB
Net Tons: 35.11

BOL: 11905

Origin	Yards	Material	Billing	Quantity
Not Applicable	0.00 YD	SW CONTAMINATED SOIL	35.11	TN

Driver: _____



Weighmaster: _____

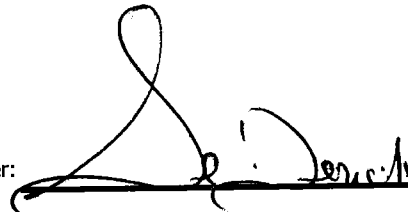

HOLDENS

Indemnification. Customer agrees, by signature above, to indemnify, hold harmless, and defend Republic Services, Inc., its subsidiaries, affiliates, employees, officers and directors from and against any and all liabilities, claims, penalties, forfeitures, suits and the costs and expenses incident thereto, including costs of defense, settlement, and reasonable attorney's fees, which may be incurred, as a result of death or injuries to any person, or damage to any property, contamination of or adverse effects on the environment, caused in whole or in part by the Customer, its employees, or subcontractors in disposing waste at this Facility. In the event Customer delivers Unacceptable Waste (as determined by Republic) Customer agrees to assume all expenses and obligations with the removal and/or resolution of any effects caused by the delivery of such Unacceptable Waste.

Indemnización. Cliente acuerda indemnizar, mantener inmune, y defender Republic Services, Inc., sus subsidiarios, compañías, divisiones, empleados, oficiales y directores contra de cualquiera y de todas responsabilidades, demandas, penas, pérdidas, juicios, pleitos y los costos incidente además, incluyendo costos de defensa, de acuerdo judicial, y de honorarios razonables del abogado, que pueden ser incurridos en, o como resultado de, la muerte o herida personal a cualquier persona, o daños a cualquier característica, propiedad, contaminación de la tierra o efectos ilícitos en esta Facilidad, causado entero o en parte por el cliente, sus empleados, o sus subcontratistas en botar basura en esta Facilidad. En el caso que el Cliente entrega, bota, basura (según lo determinado por Republic) en este Establecimiento basura inaceptable en los reglamentos de este Establecimiento, el Cliente se compromete asumir todos los costos y obligaciones con el retiro y/o la resolución de cualquier dano(s) causado por la entrega de tal basura inaceptable.



NON-HAZARDOUS WASTE MANIFEST

MANIFEST # 11905

GENERATOR INFORMATION

Generator Name: Tronox LLC
Address: P.O. Box 55
City: Henderson County: Clark
State: NV Zip: 89009
Site Location (if different): 560 W. Lake Mead
Henderson, NV 89015 (702) 592-7727

CUSTOMER/BILLING INFORMATION

Billing Name: NGE LLC c/o Northgate Environment Management
Address: 300 Frank Ogawa Plaza, Ste 510
City: Oakland County: Alameda
State: CA Zip: 94612

Table with 5 columns: Republic Services Approval #, Description of Waste, Volume/Weight, Expiration Date, Container Type. Row 1: 38251011244, Soil for disposal, 35 1/2 tons, 12-31-2011, Tractor with Dump Trailer(s). Row 2: RZ- #

*Attach Additional Sheet if necessary

I hereby certify that the above-described materials are non-hazardous wastes as defined by 40 CFR 261 or any applicable state law. Further, that the above named materials are properly classified, described, packaged, marked and labeled, and are in proper condition for transportation according to the applicable regulations of the Department of Transportation.

Susan Crowley (Signature)
Generator/Authorized Agent Name Signature Date Shipped

TRANSPORTER INFORMATION

Transporter Name: Las Vegas Paving DOT # 191949
Address: 4420 S. Decatur Truck Number: 261
Las Vegas, NV 89103 Phone Number: (702) 353-4355

I certify no hazardous waste or other regulated substance was knowingly introduced to the waste while in my custody. The waste transported in this vehicle is the waste identified above, to the best of my knowledge.

(Signature) (Signature) 5 OCT 16
Name of Authorized Agent Signature Date Delivered

DISPOSAL SITE INFORMATION

Site Name: Apex Regional Landfill Phone No. (702) 599-5920
Address: 13550 U.S. Hwy 93 Las Vegas, NV

I hereby acknowledge receipt of the above described materials
(Signature) 06 Oct 16
Name (Print or Type) Signature Date Received

81 Environmental Tech
13550 N Highway 93
Las Vegas, NV 89165

Ticket Type: INBOUND INVOICE

Ticket Number: 1810
Date: 10/06/2010
Time In: 2:10 am
Time Out: 2:29 am

Customer: 001011 - NGE, LLC c/o Northgate Environ Mgmt

Vehicle/Container: 82418P
Contract: Northgate Env. On Site Soils 3825 11
Comment: 3825 10 11244

Gross Weight: 137,380 LB Manual In
Tare Weight: 62,060 LB Scale Out
Net Weight: 75320 LB
Net Tons: 37.66

BOL: 11903

Origin	Yards	Material	Billing	Quantity
Not Applicable	0.00 YD	SW CONTAMINATED SOIL	37.66	TN

Driver:

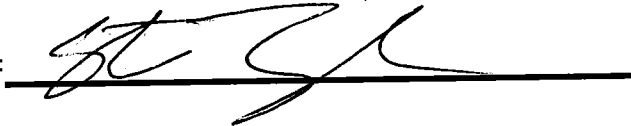

Weighmaster:

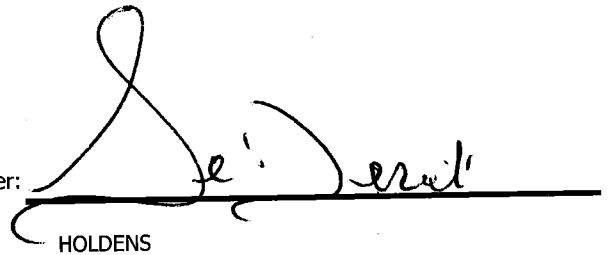

HOLDENS

Indemnification. Customer agrees, by signature above, to indemnify, hold harmless, and defend Republic Services, Inc., its subsidiaries, affiliates, employees, officers and directors from and against any and all liabilities, claims, penalties, forfeitures, suits and the costs and expenses incident thereto, including costs of defense, settlement, and reasonable attorney's fees, which may be incurred, as a result of death or injuries to any person, or damage to any property, contamination of or adverse effects on the environment, caused in whole or in part by the Customer, its employees, or subcontractors in disposing waste at this Facility. In the event Customer delivers Unacceptable Waste (as determined by Republic) Customer agrees to assume all expenses and obligations with the removal and/or resolution of any effects caused by the delivery of such Unacceptable Waste.

Indemnización. Cliente acuerda indemnizar, mantener inmune, y defender Republic Services, Inc., sus subsidiarios, compañías, divisiones, empleados, oficiales y directores contra de cualquiera y de todas responsabilidades, demandas, penas, pérdidas, juicios, pleitos y los costos incidente además, incluyendo costos de defensa, de acuerdo judicial, y de honorarios razonables del abogado, que pueden ser incurridos en, o como resultado de, la muerte o herida personal a cualquier persona, o daños a cualquier característica, propiedad, contaminación de la tierra o efectos ilícitos en esta Facilidad, causado entero o en parte por el cliente, sus empleados, o sus subcontratistas en botar basura en esta Facilidad. En el caso que el Cliente entrega, bota, basura (según lo determinado por Republic) en este Establecimiento basura inaceptable en los reglamentos de este Establecimiento, el Cliente se compromete asumir todos los costos y obligaciones con el retiro y/o la resolución de cualquier dano(s) causado por la entrega de tal basura inaceptable.



NON-HAZARDOUS WASTE MANIFEST

MANIFEST # 11903

GENERATOR INFORMATION

Generator Name: Tronox LLC
Address: P.O. Box 55
City: Henderson County: Clark
State: NV Zip: 89009
Site Location (if different): 560 W. Lake Mead
Henderson, NV 89015 (702) 592-7727

CUSTOMER/BILLING INFORMATION

Billing Name: NGE LLC c/o Northgate Environment Management
Address: 300 Frank Ogawa Plaza, Ste 510
City: Oakland County: Alameda
State: CA Zip: 94612

Table with 5 columns: Republic Services Approval #, Description of Waste, Volume/Weight, Expiration Date, Container Type. Row 1: 38251011244, Soil for disposal, 37 66/150, 12-31-2011, Tractor with Dump Trailer(s).

*Attach Additional Sheet if necessary

I hereby certify that the above-described materials are non-hazardous wastes as defined by 40 CFR 261 or any applicable state law. Further, that the above named materials are properly classified, described, packaged, marked and labeled, and are in proper condition for transportation according to the applicable regulations of the Department of Transportation.

Susan Crowley (Signature)
Generator/Authorized Agent Name Signature Date Shipped

TRANSPORTER INFORMATION

Transporter Name: Las Vegas Paving DOT # 191949
Address: 4420 S. Decatur Truck Number: 220
Las Vegas, NV 89103 Phone Number: (702) 353-4355

I certify no hazardous waste or other regulated substance was knowingly introduced to the waste while in my custody. The waste transported in this vehicle is the waste identified above, to the best of my knowledge.

STEVE TAYLOR (Signature) 10-5-10
Name of Authorized Agent Signature Date Delivered

DISPOSAL SITE INFORMATION

Site Name: Apex Regional Landfill Phone No. (702) 599-5920
Address: 13550 U.S. Hwy 93 Las Vegas, NV

I hereby acknowledge receipt of the above described materials
Holden, Se' Serial (Signature) 06 Oct 10
Name (Print or Type) Signature Date Received

81 Environmental Tech
13550 N Highway 93
Las Vegas, NV 89165

Ticket Type: INBOUND INVOICE

Ticket Number: 1811
Date: 10/06/2010
Time In: 2:24 am
Time Out: 2:43 am

Customer: 001011 - NGE, LLC c/o Northgate Environ Mgmt

Vehicle/Container: 81496P
Contract: Northgate Env. On Site Soils 3825 11
Comment: 3825 10 11244

Gross Weight: 118,280 LB Manual In
Tare Weight: 50,360 LB Manual Out
Net Weight: 67920 LB
Net Tons: 33.96

BOL: 11907

Origin	Yards	Material	Billing	Quantity
Not Applicable	0.00 YD	SW CONTAMINATED SOIL	33.96	TN

Driver: _____



Weighmaster: _____

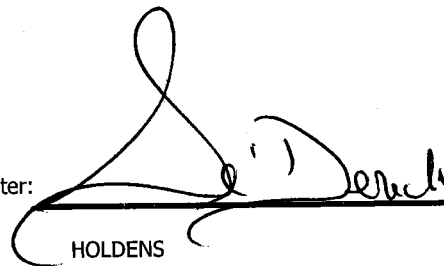

HOLDENS

Indemnification. Customer agrees, by signature above, to indemnify, hold harmless, and defend Republic Services, Inc., its subsidiaries, affiliates, employees, officers and directors from and against any and all liabilities, claims, penalties, forfeitures, suits and the costs and expenses incident thereto, including costs of defense, settlement, and reasonable attorney's fees, which may be incurred, as a result of death or injuries to any person, or damage to any property, contamination of or adverse effects on the environment, caused in whole or in part by the Customer, its employees, or subcontractors in disposing waste at this Facility. In the event Customer delivers Unacceptable Waste (as determined by Republic) Customer agrees to assume all expenses and obligations with the removal and/or resolution of any effects caused by the delivery of such Unacceptable Waste.

Indemnización. Cliente acuerda indemnizar, mantener inmune, y defender Republic Services, Inc., sus subsidiarios, compañías, divisiones, empleados, oficiales y directores contra de cualquiera y de todas responsabilidades, demandas, penas, pérdidas, juicios, pleitos y los costos incidente además, incluyendo costos de defensa, de acuerdo judicial, y de honorarios razonables del abogado, que pueden ser incurridos en, o como resultado de, la muerte o herida personal a cualquier persona, o daños a cualquier característica, propiedad, contaminación de la tierra o efectos ilícitos en esta Facilidad, causado entero o en parte por el cliente, sus empleados, o sus subcontratistas en botar basura en esta Facilidad. En el caso que el Cliente entrega, bota, basura (según lo determinado por Republic) en este Establecimiento basura inaceptable en los reglamentos de este Establecimiento, el Cliente se compromete asumir todos los costos y obligaciones con el retiro y/o la resolución de cualquier dano(s) causado por la entrega de tal basura inaceptable.



NON-HAZARDOUS WASTE MANIFEST

MANIFEST # 11907

GENERATOR INFORMATION

Generator Name: Tronox LLC

Address: P.O. Box 55

City: Henderson County: Clark

State: NV Zip: 89009

Site Location (if different): 560 W. Lake Mead

Henderson, NV 89015 (702) 592-7727

CUSTOMER/BILLING INFORMATION

Billing Name: NGE LLC c/o Northgate Environment Management

Address: 300 Frank Ogawa Plaza, Ste 510

City: Oakland County: Alameda

State: CA Zip: 94612

Republic Services Approval #	Description of Waste	Volume/Weight	Expiration Date	Container Type
38251011244	Soil for disposal	33 ⁹⁶ / ₇₅₀	12-31-2011	Tractor with Dump Trailer(s)
	RZ- #			

*Attach Additional Sheet if necessary

I hereby certify that the above-described materials are non-hazardous wastes as defined by 40 CFR 261 or any applicable state law. Further, that the above named materials are properly classified, described, packaged, marked and labeled, and are in proper condition for transportation according to the applicable regulations of the Department of Transportation.

Susan Crowley (Signature) Generator/Authorized Agent Name Signature Date Shipped

TRANSPORTER INFORMATION

Transporter Name: Las Vegas Paving

DOT # 191949

Address: 4420 S. Decatur

Truck Number: 145

Las Vegas, NV 89103

Phone Number: (702) 353-4355

I certify no hazardous waste or other regulated substance was knowingly introduced to the waste while in my custody. The waste transported in this vehicle is the waste identified above, to the best of my knowledge.

Harry M'Gil (Signature) Name of Authorized Agent Signature Date Delivered 10-5-10

DISPOSAL SITE INFORMATION

Site Name: Apex Regional Landfill

Phone No. (702) 599-5920

Address: 13550 U.S. Hwy 93 Las Vegas, NV

I hereby acknowledge receipt of the above described materials Holden, So' Derrick (Signature) Name (Print or Type) Signature Date Received 06 Oct 10

81 Environmental Tech
13550 N Highway 93
Las Vegas, NV 89165

Ticket Type: INBOUND INVOICE

Ticket Number: 1812
Date: 10/06/2010
Time In: 2:26 am
Time Out: 2:45 am

Customer: 001011 - NGE, LLC c/o Northgate Environ Mgmt

Vehicle/Container: 76810P
Contract: Northgate Env. On Site Soils 3825 11
Comment: 3825 10 11244

Gross Weight: 125,740 LB Manual In
Tare Weight: 55,640 LB Manual Out
Net Weight: 70100 LB
Net Tons: 35.05

BOL: 11906

Origin	Yards	Material	Billing	Quantity
Not Applicable	0.00 YD	SW CONTAMINATED SOIL	35.05	TN

Driver:



Weighmaster:

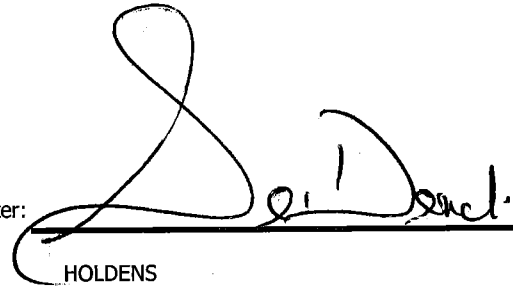

HOLDENS

Indemnification. Customer agrees, by signature above, to indemnify, hold harmless, and defend Republic Services, Inc., its subsidiaries, affiliates, employees, officers and directors from and against any and all liabilities, claims, penalties, forfeitures, suits and the costs and expenses incident thereto, including costs of defense, settlement, and reasonable attorney's fees, which may be incurred, as a result of death or injuries to any person, or damage to any property, contamination of or adverse effects on the environment, caused in whole or in part by the Customer, its employees, or subcontractors in disposing waste at this Facility. In the event Customer delivers Unacceptable Waste (as determined by Republic) Customer agrees to assume all expenses and obligations with the removal and/or resolution of any effects caused by the delivery of such Unacceptable Waste.

Indemnización. Cliente acuerda indemnizar, mantener inmune, y defender Republic Services, Inc., sus subsidiarios, compañías, divisiones, empleados, oficiales y directores contra de cualquiera y de todas responsabilidades, demandas, penas, pérdidas, juicios, pleitos y los costos incidente además, incluyendo costos de defensa, de acuerdo judicial, y de honorarios razonables del abogado, que pueden ser incurridos en, o como resultado de, la muerte o herida personal a cualquier persona, o daños a cualquier característica, propiedad, contaminación de la tierra o efectos ilícitos en esta Facilidad, causado entero o en parte por el cliente, sus empleados, o sus subcontratistas en botar basura en esta Facilidad. En el caso que el Cliente entrega, bota, basura (según lo determinado por Republic) en este Establecimiento basura inaceptable en los reglamentos de este Establecimiento, el Cliente se compromete asumir todos los costos y obligaciones con el retiro y/o la resolución de cualquier dano(s) causado por la entrega de tal basura inaceptable.



NON-HAZARDOUS WASTE MANIFEST

MANIFEST # 11906

GENERATOR INFORMATION

Generator Name: Tronox LLC

Address: P.O. Box 55

City: Henderson County: Clark

State: NV Zip: 89009

Site Location (if different): 560 W. Lake Mead

Henderson, NV 89015 (702) 592-7727

CUSTOMER/BILLING INFORMATION

Billing Name: NGE LLC c/o Northgate Environment Management

Address: 300 Frank Ogawa Plaza, Ste 510

City: Oakland County: Alameda

State: CA Zip: 94612

Table with 5 columns: Republic Services Approval #, Description of Waste, Volume/Weight, Expiration Date, Container Type. Row 1: 38251011244, Soil for disposal, 35 05/10, 12-31-2011, Tractor with Dump Trailer(s).

*Attach Additional Sheet if necessary

I hereby certify that the above-described materials are non-hazardous wastes as defined by 40 CFR 261 or any applicable state law. Further, that the above named materials are properly classified, described, packaged, marked and labeled, and are in proper condition for transportation according to the applicable regulations of the Department of Transportation.

Susan Crowley (Signature) Generator/Authorized Agent Name Signature Date Shipped

TRANSPORTER INFORMATION

Transporter Name: Las Vegas Paving

DOT # 191949

Address: 4420 S. Decatur

Truck Number: 241

Las Vegas, NV 89103

Phone Number: (702) 353-4355

I certify no hazardous waste or other regulated substance was knowingly introduced to the waste while in my custody. The waste transported in this vehicle is the waste identified above, to the best of my knowledge.

(Signature) (Signature) 10-5-2010 Name of Authorized Agent Signature Date Delivered

DISPOSAL SITE INFORMATION

Site Name: Apex Regional Landfill

Phone No. (702) 599-5920

Address: 13550 U.S. Hwy 93 Las Vegas, NV

I hereby acknowledge receipt of the above described materials

(Signature) (Signature) 06 Oct 10 Name (Print or Type) Signature Date Received

81 Environmental Tech
13550 N Highway 93
Las Vegas, NV 89165

Ticket Type: INBOUND INVOICE

Ticket Number: 1813
Date: 10/06/2010
Time In: 2:29 am
Time Out: 2:54 am

Customer: 001011 - NGE, LLC c/o Northgate Environ Mgmt

Vehicle/Container: 34330A
Contract: Northgate Env. On Site Soils 3825 11
Comment: 3825 10 11244

Gross Weight: 122,940 LB Manual In
Tare Weight: 53,140 LB Scale Out
Net Weight: 69800 LB
Net Tons: 34.90

BOL: 11908

Origin	Yards	Material	Billing	Quantity
Not Applicable	0.00 YD	SW CONTAMINATED SOIL	34.90	TN

Driver:

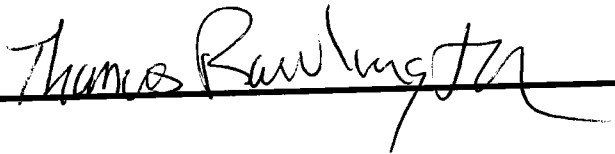

Weighmaster:

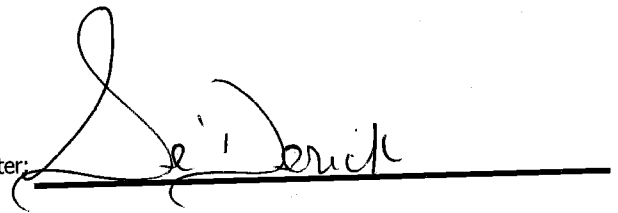

HOLDENS

Indemnification. Customer agrees, by signature above, to indemnify, hold harmless, and defend Republic Services, Inc., its subsidiaries, affiliates, employees, officers and directors from and against any and all liabilities, claims, penalties, forfeitures, suits and the costs and expenses incident thereto, including costs of defense, settlement, and reasonable attorney's fees, which may be incurred, as a result of death or injuries to any person, or damage to any property, contamination of or adverse effects on the environment, caused in whole or in part by the Customer, its employees, or subcontractors in disposing waste at this Facility. In the event Customer delivers Unacceptable Waste (as determined by Republic) Customer agrees to assume all expenses and obligations with the removal and/or resolution of any effects caused by the delivery of such Unacceptable Waste.

Indemnización. Cliente acuerda indemnizar, mantener inmune, y defender Republic Services, Inc., sus subsidiarios, compañías, divisiones, empleados, oficiales y directores contra de cualquiera y de todas responsabilidades, demandas, penas, pérdidas, juicios, pleitos y los costos incidente además, incluyendo costos de defensa, de acuerdo judicial, y de honorarios razonables del abogado, que pueden ser incurridos en, o como resultado de, la muerte o herida personal a cualquier persona, o daños a cualquier característica, propiedad, contaminación de la tierra o efectos ilícitos en esta Facilidad, causado entero o en parte por el cliente, sus empleados, o sus subcontratistas en botar basura en esta Facilidad. En el caso que el Cliente entrega, bota, basura (según lo determinado por Republic) en este Establecimiento basura inaceptable en los reglamentos de este Establecimiento, el Cliente se compromete asumir todos los costos y obligaciones con el retiro y/o la resolución de cualquier dano(s) causado por la entrega de tal basura inaceptable.



NON-HAZARDOUS WASTE MANIFEST

MANIFEST # 11908

GENERATOR INFORMATION

Generator Name: Tronox LLCAddress: P.O. Box 55City: Henderson County: ClarkState: NV Zip: 89009Site Location (if different): 560 W. Lake MeadHenderson, NV 89015 (702) 592-7727

CUSTOMER/BILLING INFORMATION

Billing Name: NGE LLC c/o Northgate Environment ManagementAddress: 300 Frank Ogawa Plaza, Ste 510City: Oakland County: AlamedaState: CA Zip: 94612

Republic Services Approval #	Description of Waste	Volume/Weight	Expiration Date	Container Type
38251011244	Soil for disposal	34 ⁹⁰ / _{ton}	12-31-2011	Tractor with Dump Trailer(s)
	RZ- _____ # _____			

*Attach Additional Sheet if necessary

I hereby certify that the above-described materials are non-hazardous wastes as defined by 40 CFR 261 or any applicable state law. Further, that the above named materials are properly classified, described, packaged, marked and labeled, and are in proper condition for transportation according to the applicable regulations of the Department of Transportation.

Susan Crowley [Signature] _____
 Generator/Authorized Agent Name Signature Date Shipped

TRANSPORTER INFORMATION

Transporter Name: Las Vegas PavingDOT # 191949Address: 4420 S. DecaturTruck Number: 981Las Vegas, NV 89103Phone Number: (702) 353-4355

I certify no hazardous waste or other regulated substance was knowingly introduced to the waste while in my custody. The waste transported in this vehicle is the waste identified above, to the best of my knowledge.

Tom Rawling Jr [Signature] 10-6-10
 Name of Authorized Agent Signature Date Delivered

DISPOSAL SITE INFORMATION

Site Name: Apex Regional LandfillPhone No. (702) 599-5920Address: 13550 U.S. Hwy 93 Las Vegas, NV

I hereby acknowledge receipt of the above described materials
Holder, Sr. Derrick [Signature] 06 Oct 10
 Name (Print or Type) Signature Date Received

81 Environmental Tech
13550 N Highway 93
Las Vegas, NV 89165

Ticket Type: INBOUND INVOICE

Ticket Number: 1814
Date: 10/06/2010
Time In: 2:31 am
Time Out: 3:02 am

Customer: 001011 - NGE, LLC c/o Northgate Environ Mgmt

Vehicle/Container: 76810P
Contract: Northgate Env. On Site Soils 3825 11
Comment: 3825 10 11244

Gross Weight: 124,760 LB Manual In
Tare Weight: 52,500 LB Scale Out
Net Weight: 72260 LB
Net Tons: 36.13

BOL: 11909

Origin	Yards	Material	Billing	Quantity
Not Applicable	0.00 YD	SW CONTAMINATED SOIL	36.13	TN

Driver:

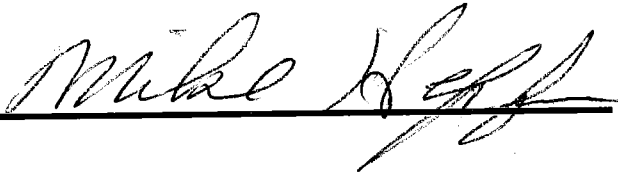

Weighmaster:

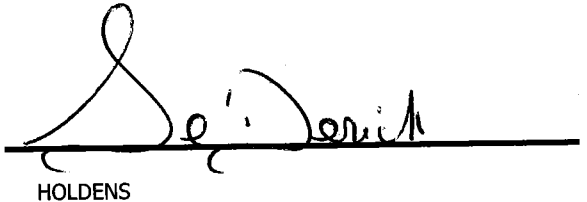

HOLDENS

Indemnification. Customer agrees, by signature above, to indemnify, hold harmless, and defend Republic Services, Inc., its subsidiaries, affiliates, employees, officers and directors from and against any and all liabilities, claims, penalties, forfeitures, suits and the costs and expenses incident thereto, including costs of defense, settlement, and reasonable attorney's fees, which may be incurred, as a result of death or injuries to any person, or damage to any property, contamination of or adverse effects on the environment, caused in whole or in part by the Customer, its employees, or subcontractors in disposing waste at this Facility. In the event Customer delivers Unacceptable Waste (as determined by Republic) Customer agrees to assume all expenses and obligations with the removal and/or resolution of any effects caused by the delivery of such Unacceptable Waste.

Indemnización. Cliente acuerda indemnizar, mantener inmune, y defender Republic Services, Inc., sus subsidiarios, compañías, divisiones, empleados, oficiales y directores contra de cualquiera y de todas responsabilidades, demandas, penas, pérdidas, juicios, pleitos y los costos incidente además, incluyendo costos de defensa, de acuerdo judicial, y de honorarios razonables del abogado, que pueden ser incurridos en, o como resultado de, la muerte o herida personal a cualquier persona, o daños a cualquier característica, propiedad, contaminación de la tierra o efectos ilícitos en esta Facilidad, causado entero o en parte por el cliente, sus empleados, o sus subcontratistas en botar basura en esta Facilidad. En el caso que el Cliente entrega, bota, basura (según lo determinado por Republic) en este Establecimiento basura inaceptable en los reglamentos de este Establecimiento, el Cliente se compromete asumir todos los costos y obligaciones con el retiro y/o la resolución de cualquier dano(s) causado por la entrega de tal basura inaceptable.



NON-HAZARDOUS WASTE MANIFEST

MANIFEST # 11909

GENERATOR INFORMATION

Generator Name: Tronox LLC

Address: P.O. Box 55

City: Henderson County: Clark

State: NV Zip: 89009

Site Location (if different): 560 W. Lake Mead

Henderson, NV 89015 (702) 592-7727

CUSTOMER/BILLING INFORMATION

Billing Name: NGE LLC c/o Northgate Environment Management

Address: 300 Frank Ogawa Plaza, Ste 510

City: Oakland County: Alameda

State: CA Zip: 94612

Republic Services Approval #	Description of Waste	Volume/Weight	Expiration Date	Container Type
38251011244	Soil for disposal	36 LB	12-31-2011	Tractor with Dump Trailer(s)
	RZ- #			

*Attach Additional Sheet if necessary

I hereby certify that the above-described materials are non-hazardous wastes as defined by 40 CFR 261 or any applicable state law. Further, that the above named materials are properly classified, described, packaged, marked and labeled, and are in proper condition for transportation according to the applicable regulations of the Department of Transportation.

Susan Crowley Generator/Authorized Agent Name Signature Date Shipped

TRANSPORTER INFORMATION

Transporter Name: Las Vegas Paving DOT # 191949

Address: 4420 S. Decatur Truck Number: 272

Las Vegas, NV 89103 Phone Number: (702) 353-4355

I certify no hazardous waste or other regulated substance was knowingly introduced to the waste while in my custody. The waste transported in this vehicle is the waste identified above, to the best of my knowledge.

Mike Hefferon Name of Authorized Agent Signature Date Delivered

DISPOSAL SITE INFORMATION

Site Name: Apex Regional Landfill Phone No. (702) 599-5920

Address: 13550 U.S. Hwy 93 Las Vegas, NV

I hereby acknowledge receipt of the above described materials Holden S. ... Name (Print or Type) Signature Date Received

81 Environmental Tech
13550 N Highway 93
Las Vegas, NV 89165

Ticket Type: INBOUND INVOICE

Ticket Number: 1815
Date: 10/06/2010
Time In: 2:43 am
Time Out: 3:05 am

Customer: 001011 - NGE, LLC c/o Northgate Environ Mgmt

Vehicle/Container: 36864A
Contract: Northgate Env. On Site Soils 3825 11
Comment: 3825 10 11244

Gross Weight: 123,240 LB Manual In
Tare Weight: 48,460 LB Manual Out
Net Weight: 74780 LB
Net Tons: 37.39

BOL: 11910

Origin	Yards	Material	Billing Quantity
Not Applicable	0.00 YD	SW CONTAMINATED SOIL	37.39 TN

Driver:

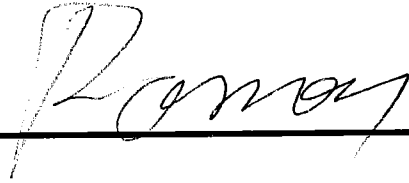

Weighmaster:

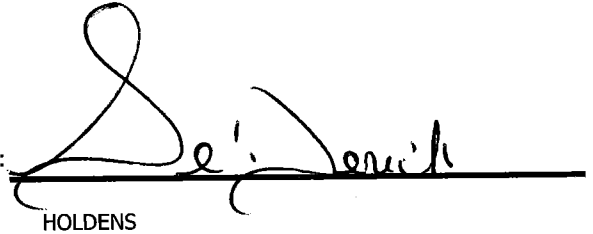

HOLDENS

Indemnification. Customer agrees, by signature above, to indemnify, hold harmless, and defend Republic Services, Inc., its subsidiaries, affiliates, employees, officers and directors from and against any and all liabilities, claims, penalties, forfeitures, suits and the costs and expenses incident thereto, including costs of defense, settlement, and reasonable attorney's fees, which may be incurred, as a result of death or injuries to any person, or damage to any property, contamination of or adverse effects on the environment, caused in whole or in part by the Customer, its employees, or subcontractors in disposing waste at this Facility. In the event Customer delivers Unacceptable Waste (as determined by Republic) Customer agrees to assume all expenses and obligations with the removal and/or resolution of any effects caused by the delivery of such Unacceptable Waste.

Indemnización. Cliente acuerda indemnizar, mantener inmune, y defender Republic Services, Inc., sus subsidiarios, compañías, divisiones, empleados, oficiales y directores contra de cualquiera y de todas responsabilidades, demandas, penas, pérdidas, juicios, pleitos y los costos incidente además, incluyendo costos de defensa, de acuerdo judicial, y de honorarios razonables del abogado, que pueden ser incurridos en, o como resultado de, la muerte o herida personal a cualquier persona, o daños a cualquier característica, propiedad, contaminación de la tierra o efectos ilícitos en esta Facilidad, causado entero o en parte por el cliente, sus empleados, o sus subcontratistas en botar basura en esta Facilidad. En el caso que el Cliente entrega, bota, basura (según lo determinado por Republic) en este Establecimiento basura inaceptable en los reglamentos de este Establecimiento, el Cliente se compromete asumir todos los costos y obligaciones con el retiro y/o la resolución de cualquier dano(s) causado por la entrega de tal basura inaceptable.



NON-HAZARDOUS WASTE MANIFEST

MANIFEST # 11910

GENERATOR INFORMATION

Generator Name: Tronox LLC

Address: P.O. Box 55

City: Henderson County: Clark

State: NV Zip: 89009

Site Location (if different): 560 W. Lake Mead

Henderson, NV 89015 (702) 592-7727

CUSTOMER/BILLING INFORMATION

Billing Name: NGE LLC c/o Northgate Environment Management

Address: 300 Frank Ogawa Plaza, Ste 510

City: Oakland County: Alameda

State: CA Zip: 94612

Table with 5 columns: Republic Services Approval #, Description of Waste, Volume/Weight, Expiration Date, Container Type. Row 1: 38251011244, Soil for disposal, 37 34/18, 12-31-2011, Tractor with Dump Trailer(s). Row 2: RZ- #

*Attach Additional Sheet if necessary

I hereby certify that the above-described materials are non-hazardous wastes as defined by 40 CFR 261 or any applicable state law. Further, that the above named materials are properly classified, described, packaged, marked and labeled, and are in proper condition for transportation according to the applicable regulations of the Department of Transportation.

Susan Crowley Generator/Authorized Agent Name Signature Date Shipped

TRANSPORTER INFORMATION

Transporter Name: Las Vegas Paving

DOT # 191949

Address: 4420 S. Decatur

Truck Number: 15001

Las Vegas, NV 89103

Phone Number: (702) 353-4355

I certify no hazardous waste or other regulated substance was knowingly introduced to the waste while in my custody. The waste transported in this vehicle is the waste identified above, to the best of my knowledge.

Name of Authorized Agent Signature Date Delivered

DISPOSAL SITE INFORMATION

Site Name: Apex Regional Landfill

Phone No. (702) 599-5920

Address: 13550 U.S. Hwy 93 Las Vegas, NV

I hereby acknowledge receipt of the above described materials Name (Print or Type) Signature Date Received

81 Environmental Tech
13550 N Highway 93
Las Vegas, NV 89165

Ticket Type: INBOUND INVOICE

Ticket Number: 1816
Date: 10/06/2010
Time In: 2:54 am
Time Out: 3:21 am

Customer: 001011 - NGE, LLC c/o Northgate Environ Mgmt

Vehicle/Container: 44166A
Contract: Northgate Env. On Site Soils 3825 1
Comment: 3825 10 11244

Gross Weight: 133,120 LB Manual In
Tare Weight: 56,880 LB Scale Out
Net Weight: 76,240 LB
Net Tons: 38.12

BOL: 11911

Origin	Yards	Material	Billing Quantity
Not Applicable	0.00 YD	SW CONTAMINATED SOIL	38.12 TN

Driver: _____



Weighmaster: _____

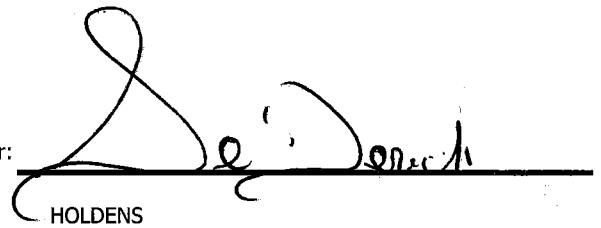

HOLDENS

Indemnification. Customer agrees, by signature above, to indemnify, hold harmless, and defend Republic Services, Inc., its subsidiaries, affiliates, employees, officers and directors from and against any and all liabilities, claims, penalties, forfeitures, suits and the costs and expenses incident thereto, including costs of defense, settlement, and reasonable attorney's fees, which may be incurred, as a result of death or injuries to any person, or damage to any property, contamination of or adverse effects on the environment, caused in whole or in part by the Customer, its employees, or subcontractors in disposing waste at this Facility. In the event Customer delivers Unacceptable Waste (as determined by Republic) Customer agrees to assume all expenses and obligations with the removal and/or resolution of any effects caused by the delivery of such Unacceptable Waste.

Indemnización. Cliente acuerda indemnizar, mantener inmune, y defender Republic Services, Inc., sus subsidiarios, compañías, divisiones, empleados, oficiales y directores contra de cualquiera y de todas responsabilidades, demandas, penas, pérdidas, juicios, pleitos y los costos incidente además, incluyendo costos de defensa, de acuerdo judicial, y de honorarios razonables del abogado, que pueden ser incurridos en, o como resultado de, la muerte o herida personal a cualquier persona, o daños a cualquier característica, propiedad, contaminación de la tierra o efectos ilícitos en esta Facilidad, causado entero o en parte por el cliente, sus empleados, o sus subcontratistas en botar basura en esta Facilidad. En el caso que el Cliente entrega, bota, basura (según lo determinado por Republic) en este Establecimiento basura inaceptable en los reglamentos de este Establecimiento, el Cliente se compromete asumir todos los costos y obligaciones con el retiro y/o la resolución de cualquier dano(s) causado por la entrega de tal basura inaceptable.



NON-HAZARDOUS WASTE MANIFEST

MANIFEST # 11911

GENERATOR INFORMATION

Generator Name: Tronox LLC
Address: P.O. Box 55
City: Henderson County: Clark
State: NV Zip: 89009
Site Location (if different): 560 W. Lake Mead
Henderson, NV 89015 (702) 592-7727

CUSTOMER/BILLING INFORMATION

Billing Name: NGE LLC c/o Northgate Environment Management
Address: 300 Frank Ogawa Plaza, Ste 510
City: Oakland County: Alameda
State: CA Zip: 94612

Table with 5 columns: Republic Services Approval #, Description of Waste, Volume/Weight, Expiration Date, Container Type. Row 1: 38251011244, Soil for disposal, 39.12 tons, 12-31-2011, Tractor with Dump Trailer(s).

*Attach Additional Sheet if necessary

I hereby certify that the above-described materials are non-hazardous wastes as defined by 40 CFR 261 or any applicable state law. Further, that the above named materials are properly classified, described, packaged, marked and labeled, and are in proper condition for transportation according to the applicable regulations of the Department of Transportation.

Susan Crowley
Generator/Authorized Agent Name Signature Date Shipped

TRANSPORTER INFORMATION

Transporter Name: Las Vegas Paving DOT # 191949
Address: 4420 S. Decatur Truck Number: K002
Las Vegas, NV 89103 Phone Number: (702) 353-4355

I certify no hazardous waste or other regulated substance was knowingly introduced to the waste while in my custody. The waste transported in this vehicle is the waste identified above, to the best of my knowledge.

Hugo Castelli
Name of Authorized Agent Signature Date Delivered 10-5-10

DISPOSAL SITE INFORMATION

Site Name: Apex Regional Landfill Phone No. (702) 599-5920
Address: 13550 U.S. Hwy 93 Las Vegas, NV

I hereby acknowledge receipt of the above described materials
Name (Print or Type) Signature Date Received 06 Oct 10

81 Environmental Tech
13550 N Highway 93
Las Vegas, NV 89165

Ticket Type: INBOUND INVOICE

Ticket Number: 1817
Date: 10/06/2010
Time In: 2:55 am
Time Out: 3:22 am

Customer: 001011 - NGE, LLC c/o Northgate Environ Mgmt

Vehicle/Container: 86113P
Contract: Northgate Env. On Site Soils 3825 11
Comment: 3825 10 11244

Gross Weight: 128,800 LB Manual In
Tare Weight: 55,240 LB Manual Out
Net Weight: 73560 LB
Net Tons: 36.78

BOL: 11912

Origin	Yards	Material	Billing Quantity
Not Applicable	0.00 YD	SW CONTAMINATED SOIL	36.78 TN

Driver:

J. A. H.

Weighmaster:

Sei Derek

HOLDENS

Indemnification. Customer agrees, by signature above, to indemnify, hold harmless, and defend Republic Services, Inc., its subsidiaries, affiliates, employees, officers and directors from and against any and all liabilities, claims, penalties, forfeitures, suits and the costs and expenses incident thereto, including costs of defense, settlement, and reasonable attorney's fees, which may be incurred, as a result of death or injuries to any person, or damage to any property, contamination of or adverse effects on the environment, caused in whole or in part by the Customer, its employees, or subcontractors in disposing waste at this Facility. In the event Customer delivers Unacceptable Waste (as determined by Republic) Customer agrees to assume all expenses and obligations with the removal and/or resolution of any effects caused by the delivery of such Unacceptable Waste.

Indemnización. Cliente acuerda indemnizar, mantener inmune, y defender Republic Services, Inc., sus subsidiarios, compañías, divisiones, empleados, oficiales y directores contra de cualquiera y de todas responsabilidades, demandas, penas, pérdidas, juicios, pleitos y los costos incidente además, incluyendo costos de defensa, de acuerdo judicial, y de honorarios razonables del abogado, que pueden ser incurridos en, o como resultado de, la muerte o herida personal a cualquier persona, o daños a cualquier característica, propiedad, contaminación de la tierra o efectos ilícitos en esta Facilidad, causado entero o en parte por el cliente, sus empleados, o sus subcontratistas en botar basura en esta Facilidad. En el caso que el Cliente entrega, bota, basura (según lo determinado por Republic) en este Establecimiento basura inaceptable en los reglamentos de este Establecimiento, el Cliente se compromete asumir todos los costos y obligaciones con el retiro y/o la resolución de cualquier dano(s) causado por la entrega de tal basura inaceptable.



NON-HAZARDOUS WASTE MANIFEST

MANIFEST # 11912

GENERATOR INFORMATION

Generator Name: Tronox LLC

Address: P.O. Box 55

City: Henderson County: Clark

State: NV Zip: 89009

Site Location (if different): 560 W. Lake Mead

Henderson, NV 89015 (702) 592-7727

CUSTOMER/BILLING INFORMATION

Billing Name: NGE LLC c/o Northgate Environment Management

Address: 300 Frank Ogawa Plaza, Ste 510

City: Oakland County: Alameda

State: CA Zip: 94612

Republic Services Approval #	Description of Waste	Volume/Weight	Expiration Date	Container Type
38251011244	Soil for disposal	36 ⁷⁹ / ₁₀₁	12-31-2011	Tractor with Dump Trailer(s)
	RZ- _____ # _____			

*Attach Additional Sheet if necessary

I hereby certify that the above-described materials are non-hazardous wastes as defined by 40 CFR 261 or any applicable state law. Further, that the above named materials are properly classified, described, packaged, marked and labeled, and are in proper condition for transportation according to the applicable regulations of the Department of Transportation.

Susan Crowley (Signature) Generator/Authorized Agent Name Date Shipped

TRANSPORTER INFORMATION

Transporter Name: Las Vegas Paving

DOT # 191949

Address: 4420 S. Decatur

Truck Number: K0019/7

Las Vegas, NV 89103

Phone Number: (702) 353-4355

I certify no hazardous waste or other regulated substance was knowingly introduced to the waste while in my custody. The waste transported in this vehicle is the waste identified above, to the best of my knowledge.

ALBERTO (Signature) Name of Authorized Agent Signature Date Delivered Oct 5, 2010

DISPOSAL SITE INFORMATION

Site Name: Apex Regional Landfill

Phone No. (702) 599-5920

Address: 13550 U.S. Hwy 93 Las Vegas, NV

I hereby acknowledge receipt of the above described materials (Signature) Name (Print or Type) Signature Date Received 06 Oct 10

81 Environmental Tech
13550 N Highway 93
Las Vegas, NV 89165

Ticket Type: INBOUND INVOICE

Ticket Number: 1818
Date: 10/06/2010
Time In: 2:59 am
Time Out: 3:25 am

Customer: 001011 - NGE, LLC c/o Northgate Environ Mgmt

Vehicle/Container: 68263P

Contract: Northgate Env. On Site Soils 3825 11

Comment: ~~2711~~ 3925 10 11204

Gross Weight: 122,280 LB Manual In
Tare Weight: 53,160 LB Scale Out
Net Weight: 69120 LB
Net Tons: 34.56

BOL: 11913

Origin	Yards	Material	Billing	Quantity
Not Applicable	0.00 YD	SW CONTAMINATED SOIL	34.56	TN

Driver: _____

Weighmaster: _____

HOLDENS

Indemnification. Customer agrees, by signature above, to indemnify, hold harmless, and defend Republic Services, Inc., its subsidiaries, affiliates, employees, officers and directors from and against any and all liabilities, claims, penalties, forfeitures, suits and the costs and expenses incident thereto, including costs of defense, settlement, and reasonable attorney's fees, which may be incurred, as a result of death or injuries to any person, or damage to any property, contamination of or adverse effects on the environment, caused in whole or in part by the Customer, its employees, or subcontractors in disposing waste at this Facility. In the event Customer delivers Unacceptable Waste (as determined by Republic) Customer agrees to assume all expenses and obligations with the removal and/or resolution of any effects caused by the delivery of such Unacceptable Waste.

Indemnización. Cliente acuerda indemnizar, mantener inmune, y defender Republic Services, Inc., sus subsidiarios, compañías, divisiones, empleados, oficiales y directores contra de cualquiera y de todas responsabilidades, demandas, penas, pérdidas, juicios, pleitos y los costos incidente además, incluyendo costos de defensa, de acuerdo judicial, y de honorarios razonables del abogado, que pueden ser incurridos en, o como resultado de, la muerte o herida personal a cualquier persona, o daños a cualquier característica, propiedad, contaminación de la tierra o efectos ilícitos en esta Facilidad, causado entero o en parte por el cliente, sus empleados, o sus subcontratistas en botar basura en esta Facilidad. En el caso que el Cliente entrega, bota, basura (según lo determinado por Republic) en este Establecimiento basura inaceptable en los reglamentos de este Establecimiento, el Cliente se compromete asumir todos los costos y obligaciones con el retiro y/o la resolución de cualquier dano(s) causado por la entrega de tal basura inaceptable.



NON-HAZARDOUS WASTE MANIFEST

MANIFEST # 11913

GENERATOR INFORMATION

Generator Name: Tronox LLC

Address: P.O. Box 55

City: Henderson County: Clark

State: NV Zip: 89009

Site Location (if different): 560 W. Lake Mead

Henderson, NV 89015 (702) 592-7727

CUSTOMER/BILLING INFORMATION

Billing Name: NGE LLC c/o Northgate Environment Management

Address: 300 Frank Ogawa Plaza, Ste 510

City: Oakland County: Alameda

State: CA Zip: 94612

Republic Services Approval #	Description of Waste	Volume/Weight	Expiration Date	Container Type
38251011244	Soil for disposal	34 ⁵⁶ / ₁₀₀ lb	12-31-2011	Tractor with Dump Trailer(s)
	RZ- _____ # _____			

*Attach Additional Sheet if necessary

I hereby certify that the above-described materials are non-hazardous wastes as defined by 40 CFR 261 or any applicable state law. Further, that the above named materials are properly classified, described, packaged, marked and labeled, and are in proper condition for transportation according to the applicable regulations of the Department of Transportation.

Susan Crowley
Generator/Authorized Agent Name
Signature
Date Shipped

TRANSPORTER INFORMATION

Transporter Name: Las Vegas Paving

DOT # 191949

Address: 4420 S. Decatur

Truck Number: 2711

Las Vegas, NV 89103

Phone Number: (702) 353-4355

I certify no hazardous waste or other regulated substance was knowingly introduced to the waste while in my custody. The waste transported in this vehicle is the waste identified above, to the best of my knowledge.

STEVE WAYES
Name of Authorized Agent
Signature
Date Delivered 10-5-10

DISPOSAL SITE INFORMATION

Site Name: Apex Regional Landfill

Phone No. (702) 599-5920

Address: 13550 U.S. Hwy 93 Las Vegas, NV

I hereby acknowledge receipt of the above described materials
Holden, Se'Donick
Name (Print or Type)
Signature
Date Received 06 Oct 10

81 Environmental Tech
13550 N Highway 93
Las Vegas, NV 89165

Ticket Type: INBOUND INVOICE

Ticket Number: 1819
Date: 10/06/2010
Time In: 3:03 am
Time Out: 3:26 am

Customer: 001011 - NGE, LLC c/o Northgate Environ Mgmt

Vehicle/Container: 81460P
Contract: Northgate Env. On Site Soils 3825 11
Comment: 3825 10 11244

Gross Weight: 122,060 LB Manual In
Tare Weight: 52,400 LB Manual Out
Net Weight: 69660 LB
Net Tons: 34.83

BOL: 11914

Origin	Yards	Material	Billing Quantity
Not Applicable	0.00 YD	SW CONTAMINATED SOIL	34.83 TN

Driver:



Weighmaster:

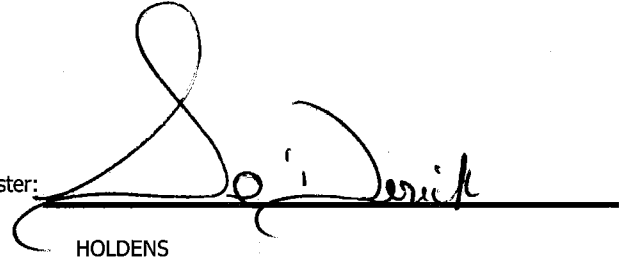

HOLDENS

Indemnification. Customer agrees, by signature above, to indemnify, hold harmless, and defend Republic Services, Inc., its subsidiaries, affiliates, employees, officers and directors from and against any and all liabilities, claims, penalties, forfeitures, suits and the costs and expenses incident thereto, including costs of defense, settlement, and reasonable attorney's fees, which may be incurred, as a result of death or injuries to any person, or damage to any property, contamination of or adverse effects on the environment, caused in whole or in part by the Customer, its employees, or subcontractors in disposing waste at this Facility. In the event Customer delivers Unacceptable Waste (as determined by Republic) Customer agrees to assume all expenses and obligations with the removal and/or resolution of any effects caused by the delivery of such Unacceptable Waste.

Indemnización. Cliente acuerda indemnizar, mantener inmune, y defender Republic Services, Inc., sus subsidiarios, compañías, divisiones, empleados, oficiales y directores contra de cualquiera y de todas responsabilidades, demandas, penas, pérdidas, juicios, pleitos y los costos incidente además, incluyendo costos de defensa, de acuerdo judicial, y de honorarios razonables del abogado, que pueden ser incurridos en, o como resultado de, la muerte o herida personal a cualquier persona, o daños a cualquier característica, propiedad, contaminación de la tierra o efectos ilícitos en esta Facilidad, causado entero o en parte por el cliente, sus empleados, o sus subcontratistas en botar basura en esta Facilidad. En el caso que el Cliente entrega, bota, basura (según lo determinado por Republic) en este Establecimiento basura inaceptable en los reglamentos de este Establecimiento, el Cliente se compromete asumir todos los costos y obligaciones con el retiro y/o la resolución de cualquier dano(s) causado por la entrega de tal basura inaceptable.



NON-HAZARDOUS WASTE MANIFEST

MANIFEST # 11914

GENERATOR INFORMATION

Generator Name: Tronox LLC
Address: P.O. Box 55
City: Henderson County: Clark
State: NV Zip: 89009
Site Location (if different): 560 W. Lake Mead
Henderson, NV 89015 (702) 592-7727

CUSTOMER/BILLING INFORMATION

Billing Name: NGE LLC c/o Northgate Environment Management
Address: 300 Frank Ogawa Plaza, Ste 510
City: Oakland County: Alameda
State: CA Zip: 94612

Table with 5 columns: Republic Services Approval #, Description of Waste, Volume/Weight, Expiration Date, Container Type. Row 1: 38251011244, Soil for disposal, 34 83/100, 12-31-2011, Tractor with Dump Trailer(s). Row 2: RZ- #

*Attach Additional Sheet if necessary

I hereby certify that the above-described materials are non-hazardous wastes as defined by 40 CFR 261 or any applicable state law. Further, that the above named materials are properly classified, described, packaged, marked and labeled, and are in proper condition for transportation according to the applicable regulations of the Department of Transportation.

Susan Crowley (Signature)
Generator/Authorized Agent Name Signature Date Shipped

TRANSPORTER INFORMATION

Transporter Name: Las Vegas Paving DOT # 191949
Address: 4420 S. Decatur Truck Number: 27
Las Vegas, NV 89103 Phone Number: (702) 353-4355

I certify no hazardous waste or other regulated substance was knowingly introduced to the waste while in my custody. The waste transported in this vehicle is the waste identified above, to the best of my knowledge.

Daniel Cardenas (Signature)
Name of Authorized Agent Signature Date Delivered 10-5-2010

DISPOSAL SITE INFORMATION

Site Name: Apex Regional Landfill Phone No. (702) 599-5920
Address: 13550 U.S. Hwy 93 Las Vegas, NV

I hereby acknowledge receipt of the above described materials

Holden, Se'Derrick (Signature)
Name (Print or Type) Signature Date Received 06 Oct 10

81 Environmental Tech
13550 N Highway 93
Las Vegas, NV 89165

Ticket Type: INBOUND INVOICE

Ticket Number: 1820
Date: 10/06/2010
Time In: 3:07 am
Time Out: 3:29 am

Customer: 001011 - NGE, LLC c/o Northgate Environ Mgmt

Vehicle/Container: 44564A
Contract: Northgate Env. On Site Soils 3825 11
Comment: 3825 10 11244

Gross Weight: 124,060 LB Manual In
Tare Weight: 49,000 LB Scale Out
Net Weight: 75060 LB
Net Tons: 37.53

BOL: 11915

Origin	Yards	Material	Billing	Quantity
Not Applicable	0.00 YD	SW CONTAMINATED SOIL	37.53	TN

Driver:

Weighmaster:

HOLDENS

Indemnification. Customer agrees, by signature above, to indemnify, hold harmless, and defend Republic Services, Inc., its subsidiaries, affiliates, employees, officers and directors from and against any and all liabilities, claims, penalties, forfeitures, suits and the costs and expenses incident thereto, including costs of defense, settlement, and reasonable attorney's fees, which may be incurred, as a result of death or injuries to any person, or damage to any property, contamination of or adverse effects on the environment, caused in whole or in part by the Customer, its employees, or subcontractors in disposing waste at this Facility. In the event Customer delivers Unacceptable Waste (as determined by Republic) Customer agrees to assume all expenses and obligations with the removal and/or resolution of any effects caused by the delivery of such Unacceptable Waste.

Indemnización. Cliente acuerda indemnizar, mantener inmune, y defender Republic Services, Inc., sus subsidiarios, compañías, divisiones, empleados, oficiales y directores contra de cualquiera y de todas responsabilidades, demandas, penas, pérdidas, juicios, pleitos y los costos incidente además, incluyendo costos de defensa, de acuerdo judicial, y de honorarios razonables del abogado, que pueden ser incurridos en, o como resultado de, la muerte o herida personal a cualquier persona, o daños a cualquier característica, propiedad, contaminación de la tierra o efectos ilícitos en esta Facilidad, causado entero o en parte por el cliente, sus empleados, o sus subcontratistas en botar basura en esta Facilidad. En el caso que el Cliente entrega, bota, basura (según lo determinado por Republic) en este Establecimiento basura inaceptable en los reglamentos de este Establecimiento, el Cliente se compromete asumir todos los costos y obligaciones con el retiro y/o la resolución de cualquier dano(s) causado por la entrega de tal basura inaceptable.



NON-HAZARDOUS WASTE MANIFEST

MANIFEST # 11915

GENERATOR INFORMATION

Generator Name: Tronox LLC
Address: P.O. Box 55
City: Henderson County: Clark
State: NV Zip: 89009
Site Location (if different): 560 W. Lake Mead
Henderson, NV 89015 (702) 592-7727

CUSTOMER/BILLING INFORMATION

Billing Name: NGE LLC c/o Northgate Environment Management
Address: 300 Frank Ogawa Plaza, Ste 510
City: Oakland County: Alameda
State: CA Zip: 94612

Table with 5 columns: Republic Services Approval #, Description of Waste, Volume/Weight, Expiration Date, Container Type. Row 1: 38251011244, Soil for disposal, 37 2/3 ton, 12-31-2011, Tractor with Dump Trailer(s). Row 2: RZ- #

*Attach Additional Sheet if necessary

I hereby certify that the above-described materials are non-hazardous wastes as defined by 40 CFR 261 or any applicable state law. Further, that the above named materials are properly classified, described, packaged, marked and labeled, and are in proper condition for transportation according to the applicable regulations of the Department of Transportation.

Susan Crowley
Generator/Authorized Agent Name Signature Date Shipped

TRANSPORTER INFORMATION

Transporter Name: Las Vegas Paving DOT # 191949
Address: 4420 S. Decatur Truck Number: 1003
Las Vegas, NV 89103 Phone Number: (702) 353-4355

I certify no hazardous waste or other regulated substance was knowingly introduced to the waste while in my custody. The waste transported in this vehicle is the waste identified above, to the best of my knowledge.

Name of Authorized Agent Signature Date Delivered
CEBV CEBV 10/05/10

DISPOSAL SITE INFORMATION

Site Name: Apex Regional Landfill Phone No. (702) 599-5920
Address: 13550 U.S. Hwy 93 Las Vegas, NV

I hereby acknowledge receipt of the above described materials
Name (Print or Type) Signature Date Received
Holden, Si'Derrick Si'Derrick Holden 06 Oct 10

81 Environmental Tech
13550 N Highway 93
Las Vegas, NV 89165

Ticket Type: INBOUND INVOICE

Ticket Number: 1821
Date: 10/06/2010
Time In: 3:18 am
Time Out: 3:42 am

Customer: 001011 - NGE, LLC c/o Northgate Environ Mgmt

Vehicle/Container: 85887P
Contract: Northgate Env. On Site Soils 3825 10
Comment: 3825 10 11244

Gross Weight: 128,720 LB Manual In
Tare Weight: 50,040 LB Scale Out
Net Weight: 78680 LB
Net Tons: 39.34

BOL: 11916

Origin	Yards	Material	Billing	Quantity
Not Applicable	0.00 YD	SW CONTAMINATED SOIL	39.34	TN

Driver:

Miguel Ramos

Weighmaster:

[Signature]
HOLDENS

Indemnification. Customer agrees, by signature above, to indemnify, hold harmless, and defend Republic Services, Inc., its subsidiaries, affiliates, employees, officers and directors from and against any and all liabilities, claims, penalties, forfeitures, suits and the costs and expenses incident thereto, including costs of defense, settlement, and reasonable attorney's fees, which may be incurred, as a result of death or injuries to any person, or damage to any property, contamination of or adverse effects on the environment, caused in whole or in part by the Customer, its employees, or subcontractors in disposing waste at this Facility. In the event Customer delivers Unacceptable Waste (as determined by Republic) Customer agrees to assume all expenses and obligations with the removal and/or resolution of any effects caused by the delivery of such Unacceptable Waste.

Indemnización. Cliente acuerda indemnizar, mantener inmune, y defender Republic Services, Inc., sus subsidiarios, compañías, divisiones, empleados, oficiales y directores contra de cualquiera y de todas responsabilidades, demandas, penas, pérdidas, juicios, pleitos y los costos incidente además, incluyendo costos de defensa, de acuerdo judicial, y de honorarios razonables del abogado, que pueden ser incurridos en, o como resultado de, la muerte o herida personal a cualquier persona, o daños a cualquier característica, propiedad, contaminación de la tierra o efectos ilícitos en esta Facilidad, causado entero o en parte por el cliente, sus empleados, o sus subcontratistas en botar basura en esta Facilidad. En el caso que el Cliente entrega, bota, basura (según lo determinado por Republic) en este Establecimiento basura inaceptable en los reglamentos de este Establecimiento, el Cliente se compromete asumir todos los costos y obligaciones con el retiro y/o la resolución de cualquier dano(s) causado por la entrega de tal basura inaceptable.



NON-HAZARDOUS WASTE MANIFEST

MANIFEST # 11916

GENERATOR INFORMATION

Generator Name: Tronox LLC
Address: P.O. Box 55
City: Henderson County: Clark
State: NV Zip: 89009
Site Location (if different): 560 W. Lake Mead
Henderson, NV 89015 (702) 592-7727

CUSTOMER/BILLING INFORMATION

Billing Name: NGE LLC c/o Northgate Environment Management
Address: 300 Frank Ogawa Plaza, Ste 510
City: Oakland County: Alameda
State: CA Zip: 94612

Table with 5 columns: Republic Services Approval #, Description of Waste, Volume/Weight, Expiration Date, Container Type. Row 1: 38251011244, Soil for disposal, 39 34/100, 12-31-2011, Tractor with Dump Trailer(s). Row 2: RZ- #

*Attach Additional Sheet if necessary

I hereby certify that the above-described materials are non-hazardous wastes as defined by 40 CFR 261 or any applicable state law. Further, that the above named materials are properly classified, described, packaged, marked and labeled, and are in proper condition for transportation according to the applicable regulations of the Department of Transportation.

Susan Crowley
Generator/Authorized Agent Name Signature Date Shipped

TRANSPORTER INFORMATION

Transporter Name: Las Vegas Paving DOT # 191949
Address: 4420 S. Decatur Truck Number: 201
Las Vegas, NV 89103 Phone Number: (702) 353-4355

I certify no hazardous waste or other regulated substance was knowingly introduced to the waste while in my custody. The waste transported in this vehicle is the waste identified above, to the best of my knowledge.

Miguel
Name of Authorized Agent Signature Date Delivered 10-5-2010

DISPOSAL SITE INFORMATION

Site Name: Apex Regional Landfill Phone No: (702) 599-5920
Address: 13550 U.S. Hwy 93 Las Vegas, NV

I hereby acknowledge receipt of the above described materials
Holden, Se' Derrick
Name (Print or Type) Signature Date Received 06 Oct 10

81 Environmental Tech
13550 N Highway 93
Las Vegas, NV 89165

Ticket Type: INBOUND INVOICE

Ticket Number: 1822
Date: 10/06/2010
Time In: 3:48 am
Time Out: 4:24 am

Customer: 001011 - NGE, LLC c/o Northgate Environ Mgmt

Vehicle/Container: 192456
Contract: Northgate Env. On Site Soils 3825 11
Comment: 3825 10 11244

Gross Weight: 123,340 LB Manual In
Tare Weight: 52,720 LB Scale Out
Net Weight: 70620 LB
Net Tons: 35.31

BOL: 11918

Origin	Yards	Material	Billing Quantity
Not Applicable	0.00 YD	SW CONTAMINATED SOIL	35.31 TN

Driver: _____



Weighmaster: _____

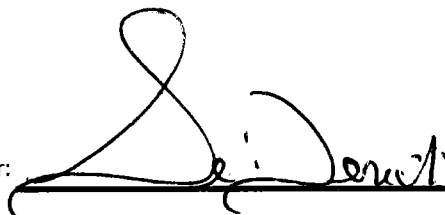

HOLDENS

Indemnification. Customer agrees, by signature above, to indemnify, hold harmless, and defend Republic Services, Inc., its subsidiaries, affiliates, employees, officers and directors from and against any and all liabilities, claims, penalties, forfeitures, suits and the costs and expenses incident thereto, including costs of defense, settlement, and reasonable attorney's fees, which may be incurred, as a result of death or injuries to any person, or damage to any property, contamination of or adverse effects on the environment, caused in whole or in part by the Customer, its employees, or subcontractors in disposing waste at this Facility. In the event Customer delivers Unacceptable Waste (as determined by Republic) Customer agrees to assume all expenses and obligations with the removal and/or resolution of any effects caused by the delivery of such Unacceptable Waste.

Indemnización. Cliente acuerda indemnizar, mantener inmune, y defender Republic Services, Inc., sus subsidiarios, compañías, divisiones, empleados, oficiales y directores contra de cualquiera y de todas responsabilidades, demandas, penas, pérdidas, juicios, pleitos y los costos incidente además, incluyendo costos de defensa, de acuerdo judicial, y de honorarios razonables del abogado, que pueden ser incurridos en, o como resultado de, la muerte o herida personal a cualquier persona, o daños a cualquier característica, propiedad, contaminación de la tierra o efectos ilícitos en esta Facilidad, causado entero o en parte por el cliente, sus empleados, o sus subcontratistas en botar basura en esta Facilidad. En el caso que el Cliente entrega, bota, basura (según lo determinado por Republic) en este Establecimiento basura inaceptable en los reglamentos de este Establecimiento, el Cliente se compromete asumir todos los costos y obligaciones con el retiro y/o la resolución de cualquier dano(s) causado por la entrega de tal basura inaceptable.



NON-HAZARDOUS WASTE MANIFEST

MANIFEST # 11918

GENERATOR INFORMATION

Generator Name: Tronox LLC

Address: P.O. Box 55

City: Henderson County: Clark

State: NV Zip: 89009

Site Location (if different): 560 W. Lake Mead

Henderson, NV 89015 (702) 592-7727

CUSTOMER/BILLING INFORMATION

Billing Name: NGE LLC c/o Northgate Environment Management

Address: 300 Frank Ogawa Plaza, Ste 510

City: Oakland County: Alameda

State: CA Zip: 94612

Republic Services Approval #	Description of Waste	Volume/Weight	Expiration Date	Container Type
38251011244	Soil for disposal	35 ³¹ / _{15n}	12-31-2011	Tractor with Dump Trailer(s)
	RZ- #			

*Attach Additional Sheet if necessary

I hereby certify that the above-described materials are non-hazardous wastes as defined by 40 CFR 261 or any applicable state law. Further, that the above named materials are properly classified, described, packaged, marked and labeled, and are in proper condition for transportation according to the applicable regulations of the Department of Transportation.

Susan Crowley

Susan Crowley

Generator/Authorized Agent Name

Signature

Date Shipped

TRANSPORTER INFORMATION

Transporter Name: Las Vegas Paving

DOT # 191949

Address: 4420 S. Decatur

Truck Number: 192456

Las Vegas, NV 89103

Phone Number: (702) 353-4355

I certify no hazardous waste or other regulated substance was knowingly introduced to the waste while in my custody. The waste transported in this vehicle is the waste identified above, to the best of my knowledge.

[Signature]

[Signature]

10/5/10

Name of Authorized Agent

Signature

Date Delivered

DISPOSAL SITE INFORMATION

Site Name: Apex Regional Landfill

Phone No. (702) 599-5920

Address: 13550 U.S. Hwy 93 Las Vegas, NV

I hereby acknowledge receipt of the above described materials

Holden, Se'Derick

Se'Derick Holden

06 Oct 10

Name (Print or Type)

Signature

Date Received

81 Environmental Tech
13550 N Highway 93
Las Vegas, NV 89165

Ticket Type: INBOUND INVOICE

Ticket Number: 1823
Date: 10/06/2010
Time In: 3:47 am
Time Out: 4:24 am

Customer: 001011 - NGE, LLC c/o Northgate Environ Mgmt

Vehicle/Container: 192457
Contract: Northgate Env. On Site Soils 3825 11
Comment: 3825 10 11244

Gross Weight: 121,700 LB Manual In
Tare Weight: 51,860 LB Manual Out
Net Weight: 69840 LB
Net Tons: 34.92

BOL: 11917

Origin	Yards	Material	Billing	Quantity
Not Applicable	0.00 YD	SW CONTAMINATED SOIL	34.92	TN

Driver: 

Weighmaster: 

HOLDENS

Indemnification. Customer agrees, by signature above, to indemnify, hold harmless, and defend Republic Services, Inc., its subsidiaries, affiliates, employees, officers and directors from and against any and all liabilities, claims, penalties, forfeitures, suits and the costs and expenses incident thereto, including costs of defense, settlement, and reasonable attorney's fees, which may be incurred, as a result of death or injuries to any person, or damage to any property, contamination of or adverse effects on the environment, caused in whole or in part by the Customer, its employees, or subcontractors in disposing waste at this Facility. In the event Customer delivers Unacceptable Waste (as determined by Republic) Customer agrees to assume all expenses and obligations with the removal and/or resolution of any effects caused by the delivery of such Unacceptable Waste.

Indemnización. Cliente acuerda indemnizar, mantener inmune, y defender Republic Services, Inc., sus subsidiarios, compañías, divisiones, empleados, oficiales y directores contra de cualquiera y de todas responsabilidades, demandas, penas, pérdidas, juicios, pleitos y los costos incidente además, incluyendo costos de defensa, de acuerdo judicial, y de honorarios razonables del abogado, que pueden ser incurridos en, o como resultado de, la muerte o herida personal a cualquier persona, o daños a cualquier característica, propiedad, contaminación de la tierra o efectos ilícitos en esta Facilidad, causado entero o en parte por el cliente, sus empleados, o sus subcontratistas en botar basura en esta Facilidad. En el caso que el Cliente entrega, bota, basura (según lo determinado por Republic) en este Establecimiento basura inaceptable en los reglamentos de este Establecimiento, el Cliente se compromete asumir todos los costos y obligaciones con el retiro y/o la resolución de cualquier dano(s) causado por la entrega de tal basura inaceptable.



NON-HAZARDOUS WASTE MANIFEST

MANIFEST # 11917

GENERATOR INFORMATION

Generator Name: Tronox LLC
Address: P.O. Box 55
City: Henderson County: Clark
State: NV Zip: 89009
Site Location (if different): 560 W. Lake Mead
Henderson, NV 89015 (702) 592-7727

CUSTOMER/BILLING INFORMATION

Billing Name: NGE LLC c/o Northgate Environment Management
Address: 300 Frank Ogawa Plaza, Ste 510
City: Oakland County: Alameda
State: CA Zip: 94612

Table with 5 columns: Republic Services Approval #, Description of Waste, Volume/Weight, Expiration Date, Container Type. Row 1: 38251011244, Soil for disposal, 34 92/150, 12-31-2011, Tractor with Dump Trailer(s).

*Attach Additional Sheet if necessary

I hereby certify that the above-described materials are non-hazardous wastes as defined by 40 CFR 261 or any applicable state law. Further, that the above named materials are properly classified, described, packaged, marked and labeled, and are in proper condition for transportation according to the applicable regulations of the Department of Transportation.

Susan Crowley (Signature)
Generator/Authorized Agent Name Signature Date Shipped

TRANSPORTER INFORMATION

Transporter Name: Las Vegas Paving DOT # 191949
Address: 4420 S. Decatur Truck Number: 192457
Las Vegas, NV 89103 Phone Number: (702) 353-4355

I certify no hazardous waste or other regulated substance was knowingly introduced to the waste while in my custody. The waste transported in this vehicle is the waste identified above, to the best of my knowledge.

Brian Brinkhoff (Signature) 10-5-10
Name of Authorized Agent Signature Date Delivered

DISPOSAL SITE INFORMATION

Site Name: Apex Regional Landfill Phone No. (702) 599-5920
Address: 13550 U.S. Hwy 93 Las Vegas, NV

I hereby acknowledge receipt of the above described materials
Holden, So. Daniel (Signature) 06 Oct 10
Name (Print or Type) Signature Date Received

81 Environmental Tech
13550 N Highway 93
Las Vegas, NV 89165

Ticket Type: INBOUND INVOICE

Ticket Number: 1824
Date: 10/06/2010
Time In: 3:53 am
Time Out: 4:26 am

Customer: 001011 - NGE, LLC c/o Northgate Environ Mgmt

Vehicle/Container: 192460
Contract: Northgate Env. On Site Soils 3825 11
Comment: 3825 10 11244

Gross Weight: 122,800 LB Manual In
Tare Weight: 52,920 LB Manual Out
Net Weight: 69880 LB
Net Tons: 34.94

BOL: 11919

Origin	Yards	Material	Billing Quantity
Not Applicable	0.00 YD	SW CONTAMINATED SOIL	34.94 TN

Driver:

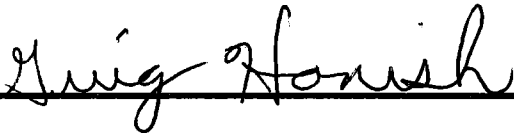

Weighmaster:

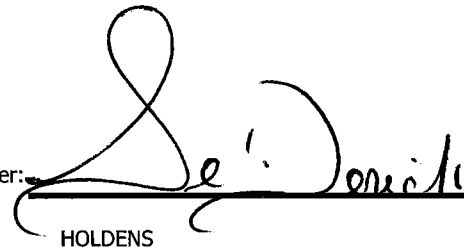

HOLDENS

Indemnification. Customer agrees, by signature above, to indemnify, hold harmless, and defend Republic Services, Inc., its subsidiaries, affiliates, employees, officers and directors from and against any and all liabilities, claims, penalties, forfeitures, suits and the costs and expenses incident thereto, including costs of defense, settlement, and reasonable attorney's fees, which may be incurred, as a result of death or injuries to any person, or damage to any property, contamination of or adverse effects on the environment, caused in whole or in part by the Customer, its employees, or subcontractors in disposing waste at this Facility. In the event Customer delivers Unacceptable Waste (as determined by Republic) Customer agrees to assume all expenses and obligations with the removal and/or resolution of any effects caused by the delivery of such Unacceptable Waste.

Indemnización. Cliente acuerda indemnizar, mantener inmune, y defender Republic Services, Inc., sus subsidiarios, compañías, divisiones, empleados, oficiales y directores contra de cualquiera y de todas responsabilidades, demandas, penas, pérdidas, juicios, pleitos y los costos incidente además, incluyendo costos de defensa, de acuerdo judicial, y de honorarios razonables del abogado, que pueden ser incurridos en, o como resultado de, la muerte o herida personal a cualquier persona, o daños a cualquier característica, propiedad, contaminación de la tierra o efectos ilícitos en esta Facilidad, causado entero o en parte por el cliente, sus empleados, o sus subcontratistas en botar basura en esta Facilidad. En el caso que el Cliente entrega, bota, basura (según lo determinado por Republic) en este Establecimiento basura inaceptable en los reglamentos de este Establecimiento, el Cliente se compromete asumir todos los costos y obligaciones con el retiro y/o la resolución de cualquier dano(s) causado por la entrega de tal basura inaceptable.



NON-HAZARDOUS WASTE MANIFEST

MANIFEST # 11919

GENERATOR INFORMATION

Generator Name: Tronox LLC
Address: P.O. Box 55
City: Henderson County: Clark
State: NV Zip: 89009
Site Location (if different): 560 W. Lake Mead
Henderson, NV 89015 (702) 592-7727

CUSTOMER/BILLING INFORMATION

Billing Name: NGE LLC c/o Northgate Environment Management
Address: 300 Frank Ogawa Plaza, Ste 510
City: Oakland County: Alameda
State: CA Zip: 94612

Table with 5 columns: Republic Services Approval #, Description of Waste, Volume/Weight, Expiration Date, Container Type. Row 1: 38251011244, Soil for disposal, 34 54/100, 12-31-2011, Tractor with Dump Trailer(s).

*Attach Additional Sheet if necessary

I hereby certify that the above-described materials are non-hazardous wastes as defined by 40 CFR 261 or any applicable state law. Further, that the above named materials are properly classified, described, packaged, marked and labeled, and are in proper condition for transportation according to the applicable regulations of the Department of Transportation.

Susan Crowley (Name)
[Signature] (Signature)
Date Shipped

TRANSPORTER INFORMATION

Transporter Name: Las Vegas Paving DOT # 191949
Address: 4420 S. Decatur Truck Number: 2460
Las Vegas, NV 89103 Phone Number: (702) 353-4355

I certify no hazardous waste or other regulated substance was knowingly introduced to the waste while in my custody. The waste transported in this vehicle is the waste identified above, to the best of my knowledge.

Gregg Honish (Name)
[Signature] (Signature)
Date Delivered: 10-5-10

DISPOSAL SITE INFORMATION

Site Name: Apex Regional Landfill Phone No. (702) 599-5920
Address: 13550 U.S. Hwy 93 Las Vegas, NV

I hereby acknowledge receipt of the above described materials
[Signature] (Signature)
Date Received: 06 Oct 10

81 Environmental Tech
13550 N Highway 93
Las Vegas, NV 89165

Ticket Type: INBOUND INVOICE

Ticket Number: 1825
Date: 10/06/2010
Time In: 4:00 am
Time Out: 4:28 am

Customer: 001011 - NGE, LLC c/o Northgate Environ Mgmt

Vehicle/Container: 35903A
Contract: Northgate Env. On Site Soils 3825 11
Comment: 3825 10 11244

Gross Weight: 124,420 LB Manual In
Tare Weight: 55,780 LB Scale Out
Net Weight: 68640 LB
Net Tons: 34.32

BOL: 11920

Origin	Yards	Material	Billing Quantity
Not Applicable	0.00 YD	SW CONTAMINATED SOIL	34.32 TN

Driver:

JAY MASON

Weighmaster

[Signature]
HOLDENS

Indemnification. Customer agrees, by signature above, to indemnify, hold harmless, and defend Republic Services, Inc., its subsidiaries, affiliates, employees, officers and directors from and against any and all liabilities, claims, penalties, forfeitures, suits and the costs and expenses incident thereto, including costs of defense, settlement, and reasonable attorney's fees, which may be incurred, as a result of death or injuries to any person, or damage to any property, contamination of or adverse effects on the environment, caused in whole or in part by the Customer, its employees, or subcontractors in disposing waste at this Facility. In the event Customer delivers Unacceptable Waste (as determined by Republic) Customer agrees to assume all expenses and obligations with the removal and/or resolution of any effects caused by the delivery of such Unacceptable Waste.

Indemnización. Cliente acuerda indemnizar, mantener inmune, y defender Republic Services, Inc., sus subsidiarios, compañías, divisiones, empleados, oficiales y directores contra de cualquiera y de todas responsabilidades, demandas, penas, pérdidas, juicios, pleitos y los costos incidente además, incluyendo costos de defensa, de acuerdo judicial, y de honorarios razonables del abogado, que pueden ser incurridos en, o como resultado de, la muerte o herida personal a cualquier persona, o daños a cualquier característica, propiedad, contaminación de la tierra o efectos ilícitos en esta Facilidad, causado entero o en parte por el cliente, sus empleados, o sus subcontratistas en botar basura en esta Facilidad. En el caso que el Cliente entrega, bota, basura (según lo determinado por Republic) en este Establecimiento basura inaceptable en los reglamentos de este Establecimiento, el Cliente se compromete asumir todos los costos y obligaciones con el retiro y/o la resolución de cualquier dano(s) causado por la entrega de tal basura inaceptable.



NON-HAZARDOUS WASTE MANIFEST

MANIFEST # 11920

GENERATOR INFORMATION

Generator Name: Tronox LLC
Address: P.O. Box 55
City: Henderson County: Clark
State: NV Zip: 89009
Site Location (if different): 560 W. Lake Mead
Henderson, NV 89015 (702) 592-7727

CUSTOMER/BILLING INFORMATION

Billing Name: NGE LLC c/o Northgate Environment Management
Address: 300 Frank Ogawa Plaza, Ste 510
City: Oakland County: Alameda
State: CA Zip: 94612

Table with 5 columns: Republic Services Approval #, Description of Waste, Volume/Weight, Expiration Date, Container Type. Row 1: 38251011244, Soil for disposal, 34 30/70, 12-31-2011, Tractor with Dump Trailer(s).

*Attach Additional Sheet if necessary

I hereby certify that the above-described materials are non-hazardous wastes as defined by 40 CFR 261 or any applicable state law. Further, that the above named materials are properly classified, described, packaged, marked and labeled, and are in proper condition for transportation according to the applicable regulations of the Department of Transportation.

Susan Crowley (Signature)
Generator/Authorized Agent Name Signature Date Shipped

TRANSPORTER INFORMATION

Transporter Name: Las Vegas Paving DOT # 191949
Address: 4420 S. Decatur Truck Number: CA
Las Vegas, NV 89103 Phone Number: (702) 353-4355

I certify no hazardous waste or other regulated substance was knowingly introduced to the waste while in my custody. The waste transported in this vehicle is the waste identified above, to the best of my knowledge.

wardco BC (Signature) 10-6-10 (Date)
Name of Authorized Agent Signature Date Delivered

DISPOSAL SITE INFORMATION

Site Name: Apex Regional Landfill Phone No. (702) 599-5920
Address: 13550 U.S. Hwy 93 Las Vegas, NV

I hereby acknowledge receipt of the above described materials
Holden, Se'Derick (Signature) 06 Oct 10 (Date)
Name (Print or Type) Signature Date Received

81 Environmental Tech
13550 N Highway 93
Las Vegas, NV 89165

Ticket Type: INBOUND INVOICE

Ticket Number: 1826
Date: 10/06/2010
Time In: 4:06 am
Time Out: 4:31 am

Customer: 001011 - NGE, LLC c/o Northgate Environ Mgmt

Vehicle/Container: 81494P
Contract: Northgate Env. On Site Soils 3825 11
Comment: 3825 10 11244

Gross Weight: 117,560 LB Manual In
Tare Weight: 42,620 LB Manual Out
Net Weight: 74940 LB
Net Tons: 37.47

BOL: 11921

Origin	Yards	Material	Billing Quantity
Not Applicable	0.00 YD	SW CONTAMINATED SOIL	37.47 TN

Driver: _____



Weighmaster: _____

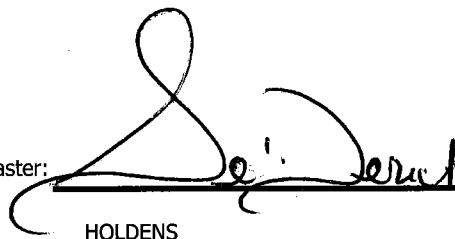

HOLDENS

Indemnification. Customer agrees, by signature above, to indemnify, hold harmless, and defend Republic Services, Inc., its subsidiaries, affiliates, employees, officers and directors from and against any and all liabilities, claims, penalties, forfeitures, suits and the costs and expenses incident thereto, including costs of defense, settlement, and reasonable attorney's fees, which may be incurred, as a result of death or injuries to any person, or damage to any property, contamination of or adverse effects on the environment, caused in whole or in part by the Customer, its employees, or subcontractors in disposing waste at this Facility. In the event Customer delivers Unacceptable Waste (as determined by Republic) Customer agrees to assume all expenses and obligations with the removal and/or resolution of any effects caused by the delivery of such Unacceptable Waste.

Indemnización. Cliente acuerda indemnizar, mantener inmune, y defender Republic Services, Inc., sus subsidiarios, compañías, divisiones, empleados, oficiales y directores contra de cualquiera y de todas responsabilidades, demandas, penas, pérdidas, juicios, pleitos y los costos incidente además, incluyendo costos de defensa, de acuerdo judicial, y de honorarios razonables del abogado, que pueden ser incurridos en, o como resultado de, la muerte o herida personal a cualquier persona, o daños a cualquier característica, propiedad, contaminación de la tierra o efectos ilícitos en esta Facilidad, causado entero o en parte por el cliente, sus empleados, o sus subcontratistas en botar basura en esta Facilidad. En el caso que el Cliente entrega, bota, basura (según lo determinado por Republic) en este Establecimiento basura inaceptable en los reglamentos de este Establecimiento, el Cliente se compromete asumir todos los costos y obligaciones con el retiro y/o la resolución de cualquier dano(s) causado por la entrega de tal basura inaceptable.



NON-HAZARDOUS WASTE MANIFEST

MANIFEST # 11921

GENERATOR INFORMATION

Generator Name: Tronox LLC
Address: P.O. Box 55
City: Henderson County: Clark
State: NV Zip: 89009
Site Location (if different): 560 W. Lake Mead
Henderson, NV 89015 (702) 592-7727

CUSTOMER/BILLING INFORMATION

Billing Name: NGE LLC c/o Northgate Environment Management
Address: 300 Frank Ogawa Plaza, Ste 510
City: Oakland County: Alameda
State: CA Zip: 94612

Table with 5 columns: Republic Services Approval #, Description of Waste, Volume/Weight, Expiration Date, Container Type. Row 1: 38251011244, Soil for disposal, 37 43/100, 12-31-2011, Tractor with Dump Trailer(s).

*Attach Additional Sheet if necessary

I hereby certify that the above-described materials are non-hazardous wastes as defined by 40 CFR 261 or any applicable state law. Further, that the above named materials are properly classified, described, packaged, marked and labeled, and are in proper condition for transportation according to the applicable regulations of the Department of Transportation.

Susan Crowley (Name)
[Signature] (Signature)
Date Shipped

TRANSPORTER INFORMATION

Transporter Name: Las Vegas Paving DOT # 191949
Address: 4420 S. Decatur Truck Number: 125
Las Vegas, NV 89103 Phone Number: (702) 353-4355

I certify no hazardous waste or other regulated substance was knowingly introduced to the waste while in my custody. The waste transported in this vehicle is the waste identified above, to the best of my knowledge.

Calvin Paguyo (Name)
[Signature] (Signature)
Date Delivered: 10-05-10

DISPOSAL SITE INFORMATION

Site Name: Apex Regional Landfill Phone No. (702) 599-5920
Address: 13550 U.S. Hwy 93 Las Vegas, NV

I hereby acknowledge receipt of the above described materials
[Signature] (Signature)
Date Received: 06 Oct 10

81 Environmental Tech
13550 N Highway 93
Las Vegas, NV 89165

Ticket Type: INBOUND INVOICE

Ticket Number: 1827
Date: 10/06/2010
Time In: 4:20 am
Time Out: 4:47 am

Customer: 001011 - NGE, LLC c/o Northgate Environ Mgmt

Vehicle/Container: 81496P
Contract: Northgate Env. On Site Soils 3825 11
Comment: 3825 10 11244

Gross Weight: 119,420 LB Manual In
Tare Weight: 50,360 LB Manual Out
Net Weight: 69,060 LB
Net Tons: 34.53

BOL: 11922

Origin	Yards	Material	Billing	Quantity
Not Applicable	0.00 YD	SW CONTAMINATED SOIL	34.53	TN

Driver:



Weighmaster:



HOLDENS

Indemnification. Customer agrees, by signature above, to indemnify, hold harmless, and defend Republic Services, Inc., its subsidiaries, affiliates, employees, officers and directors from and against any and all liabilities, claims, penalties, forfeitures, suits and the costs and expenses incident thereto, including costs of defense, settlement, and reasonable attorney's fees, which may be incurred, as a result of death or injuries to any person, or damage to any property, contamination of or adverse effects on the environment, caused in whole or in part by the Customer, its employees, or subcontractors in disposing waste at this Facility. In the event Customer delivers Unacceptable Waste (as determined by Republic) Customer agrees to assume all expenses and obligations with the removal and/or resolution of any effects caused by the delivery of such Unacceptable Waste.

Indemnización. Cliente acuerda indemnizar, mantener inmune, y defender Republic Services, Inc., sus subsidiarios, compañías, divisiones, empleados, oficiales y directores contra de cualquiera y de todas responsabilidades, demandas, penas, pérdidas, juicios, pleitos y los costos incidente además, incluyendo costos de defensa, de acuerdo judicial, y de honorarios razonables del abogado, que pueden ser incurridos en, o como resultado de, la muerte o herida personal a cualquier persona, o daños a cualquier característica, propiedad, contaminación de la tierra o efectos ilícitos en esta Facilidad, causado entero o en parte por el cliente, sus empleados, o sus subcontratistas en botar basura en esta Facilidad. En el caso que el Cliente entrega, bota, basura (según lo determinado por Republic) en este Establecimiento basura inaceptable en los reglamentos de este Establecimiento, el Cliente se compromete asumir todos los costos y obligaciones con el retiro y/o la resolución de cualquier dano(s) causado por la entrega de tal basura inaceptable.



NON-HAZARDOUS WASTE MANIFEST

MANIFEST # 11922

GENERATOR INFORMATION

Generator Name: Tronox LLC

Address: P.O. Box 55

City: Henderson County: Clark

State: NV Zip: 89009

Site Location (if different): 560 W. Lake Mead

Henderson, NV 89015 (702) 592-7727

CUSTOMER/BILLING INFORMATION

Billing Name: NGE LLC c/o Northgate Environment Management

Address: 300 Frank Ogawa Plaza, Ste 510

City: Oakland County: Alameda

State: CA Zip: 94612

Republic Services Approval #	Description of Waste	Volume/Weight	Expiration Date	Container Type
38251011244	Soil for disposal	34.53 Ton	12-31-2011	Tractor with Dump Trailer(s)
	RZ- #			

*Attach Additional Sheet if necessary

I hereby certify that the above-described materials are non-hazardous wastes as defined by 40 CFR 261 or any applicable state law. Further, that the above named materials are properly classified, described, packaged, marked and labeled, and are in proper condition for transportation according to the applicable regulations of the Department of Transportation.

Susan Crowley

Susan Crowley

Generator/Authorized Agent Name

Signature

Date Shipped

TRANSPORTER INFORMATION

Transporter Name: Las Vegas Paving

DOT # 191949

Address: 4420 S. Decatur

Truck Number: 145

Las Vegas, NV 89103

Phone Number: (702) 353-4355

I certify no hazardous waste or other regulated substance was knowingly introduced to the waste while in my custody. The waste transported in this vehicle is the waste identified above, to the best of my knowledge.

Harry McGil

Harry McGil

10-5-10

Name of Authorized Agent

Signature

Date Delivered

DISPOSAL SITE INFORMATION

Site Name: Apex Regional Landfill

Phone No. (702) 599-5920

Address: 13550 U.S. Hwy 93 Las Vegas, NV

I hereby acknowledge receipt of the above described materials

Hobden Se'Dorck

Se'Dorck Hobden

06 Oct 10

Name (Print or Type)

Signature

Date Received

81 Environmental Tech
13550 N Highway 93
Las Vegas, NV 89165

Ticket Type: INBOUND INVOICE

Ticket Number: 1828
Date: 10/06/2010
Time In: 7:07 am
Time Out: 7:28 am

Customer: 001011 - NGE, LLC c/o Northgate Environ Mgmt

Vehicle/Container: 192391
Contract: Northgate Env. On Site Soils 3825 11
Comment: 3825 10 11244

Gross Weight: 89,640 LB Scale In
Tare Weight: 39,200 LB Manual Out
Net Weight: 50440 LB
Net Tons: 25.22

BOL: 11923

Origin	Yards	Material	Billing	Quantity
Not Applicable	0.00 YD	SW CONTAMINATED SOIL	25.22	TN

Driver: _____

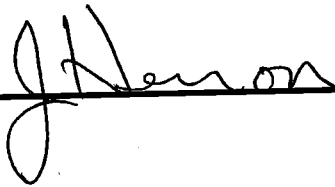

Weighmaster: _____



MORENOJ

Indemnification. Customer agrees, by signature above, to indemnify, hold harmless, and defend Republic Services, Inc., its subsidiaries, affiliates, employees, officers and directors from and against any and all liabilities, claims, penalties, forfeitures, suits and the costs and expenses incident thereto, including costs of defense, settlement, and reasonable attorney's fees, which may be incurred, as a result of death or injuries to any person, or damage to any property, contamination of or adverse effects on the environment, caused in whole or in part by the Customer, its employees, or subcontractors in disposing waste at this Facility. In the event Customer delivers Unacceptable Waste (as determined by Republic) Customer agrees to assume all expenses and obligations with the removal and/or resolution of any effects caused by the delivery of such Unacceptable Waste.

Indemnización. Cliente acuerda indemnizar, mantener inmune, y defender Republic Services, Inc., sus subsidiarios, compañías, divisiones, empleados, oficiales y directores contra de cualquiera y de todas responsabilidades, demandas, penas, pérdidas, juicios, pleitos y los costos incidente además, incluyendo costos de defensa, de acuerdo judicial, y de honorarios razonables del abogado, que pueden ser incurridos en, o como resultado de, la muerte o herida personal a cualquier persona, o daños a cualquier característica, propiedad, contaminación de la tierra o efectos ilícitos en esta Facilidad, causado entero o en parte por el cliente, sus empleados, o sus subcontratistas en botar basura en esta Facilidad. En el caso que el Cliente entrega, bota, basura (según lo determinado por Republic) en este Establecimiento basura inaceptable en los reglamentos de este Establecimiento, el Cliente se compromete asumir todos los costos y obligaciones con el retiro y/o la resolución de cualquier dano(s) causado por la entrega de tal basura inaceptable.



NON-HAZARDOUS WASTE MANIFEST

MANIFEST # 11923

GENERATOR INFORMATION

Generator Name: Tronox LLC

Address: P.O. Box 55

City: Henderson County: Clark

State: NV Zip: 89009

Site Location (if different): 560 W. Lake Mead

Henderson, NV 89015 (702) 592-7727

CUSTOMER/BILLING INFORMATION

Billing Name: NGE LLC c/o Northgate Environment Management

Address: 300 Frank Ogawa Plaza, Ste 510

City: Oakland County: Alameda

State: CA Zip: 94612

Republic Services Approval #	Description of Waste	Volume/Weight	Expiration Date	Container Type
38251011244	Soil for disposal		12-31-2011	Tractor with Dump Trailer(s)
	RZ- #	25.22 TN		

*Attach Additional Sheet if necessary

I hereby certify that the above-described materials are non-hazardous wastes as defined by 40 CFR 261 or any applicable state law. Further, that the above named materials are properly classified, described, packaged, marked and labeled, and are in proper condition for transportation according to the applicable regulations of the Department of Transportation.

Susan Crowley (Signature) Generator/Authorized Agent Name Date Shipped

TRANSPORTER INFORMATION

Transporter Name: Las Vegas Paving

DOT # 191949

Address: 4420 S. Decatur

Truck Number: 192391

Las Vegas, NV 89103

Phone Number: (702) 353-4355

I certify no hazardous waste or other regulated substance was knowingly introduced to the waste while in my custody. The waste transported in this vehicle is the waste identified above, to the best of my knowledge.

(Signature) Name of Authorized Agent Date Delivered 10-6-10

DISPOSAL SITE INFORMATION

Site Name: Apex Regional Landfill

Phone No. (702) 599-5920

Address: 13550 U.S. Hwy 93 Las Vegas, NV

I hereby acknowledge receipt of the above described materials (Signature) Name (Print or Type) Date Received 10-6-10

81 Environmental Tech
13550 N Highway 93
Las Vegas, NV 89165

Ticket Type: INBOUND INVOICE

Ticket Number: 1829
Date: 10/06/2010
Time In: 7:11 am
Time Out: 7:35 am

Customer: 001011 - NGE, LLC c/o Northgate Environ Mgmt

Vehicle/Container: 192364
Contract: Northgate Env. On Site Soils 3825 11
Comment: 3825-10-11244

Gross Weight: 90,660 LB Scale In
Tare Weight: 38,400 LB Scale Out
Net Weight: 52260 LB
Net Tons: 26.13

BOL: 11925

Origin	Yards	Material	Billing	Quantity
Not Applicable	0.00 YD	SW CONTAMINATED SOIL	26.13	TN

Driver: 

Weighmaster: 

IN - walkera OUT - MORENOJ

Indemnification. Customer agrees, by signature above, to indemnify, hold harmless, and defend Republic Services, Inc., its subsidiaries, affiliates, employees, officers and directors from and against any and all liabilities, claims, penalties, forfeitures, suits and the costs and expenses incident thereto, including costs of defense, settlement, and reasonable attorney's fees, which may be incurred, as a result of death or injuries to any person, or damage to any property, contamination of or adverse effects on the environment, caused in whole or in part by the Customer, its employees, or subcontractors in disposing waste at this Facility. In the event Customer delivers Unacceptable Waste (as determined by Republic) Customer agrees to assume all expenses and obligations with the removal and/or resolution of any effects caused by the delivery of such Unacceptable Waste.

Indemnización. Cliente acuerda indemnizar, mantener inmune, y defender Republic Services, Inc., sus subsidiarios, compañías, divisiones, empleados, oficiales y directores contra de cualquiera y de todas responsabilidades, demandas, penas, pérdidas, juicios, pleitos y los costos incidente además, incluyendo costos de defensa, de acuerdo judicial, y de honorarios razonables del abogado, que pueden ser incurridos en, o como resultado de, la muerte o herida personal a cualquier persona, o daños a cualquier característica, propiedad, contaminación de la tierra o efectos ilícitos en esta Facilidad, causado entero o en parte por el cliente, sus empleados, o sus subcontratistas en botar basura en esta Facilidad. En el caso que el Cliente entrega, bota, basura (según lo determinado por Republic) en este Establecimiento basura inaceptable en los reglamentos de este Establecimiento, el Cliente se compromete asumir todos los costos y obligaciones con el retiro y/o la resolución de cualquier dano(s) causado por la entrega de tal basura inaceptable.



NON-HAZARDOUS WASTE MANIFEST

MANIFEST # 11925

GENERATOR INFORMATION

Generator Name: Tronox LLC

Address: P.O. Box 55

City: Henderson County: Clark

State: NV Zip: 89009

Site Location (if different): 560 W. Lake Mead

Henderson, NV 89015 (702) 592-7727

CUSTOMER/BILLING INFORMATION

Billing Name: NGE LLC c/o Northgate Environment Management

Address: 300 Frank Ogawa Plaza, Ste 510

City: Oakland County: Alameda

State: CA Zip: 94612

Republic Services Approval #	Description of Waste	Volume/Weight	Expiration Date	Container Type
38251011244	Soil for disposal		12-31-2011	Tractor with Dump Trailer(s)
	RZ- _____ # _____	26.13		

*Attach Additional Sheet if necessary

I hereby certify that the above-described materials are non-hazardous wastes as defined by 40 CFR 261 or any applicable state law. Further, that the above named materials are properly classified, described, packaged, marked and labeled, and are in proper condition for transportation according to the applicable regulations of the Department of Transportation.

Susan Crowley
Generator/Authorized Agent Name

Susan Crowley
Signature

Date Shipped

TRANSPORTER INFORMATION

Transporter Name: Las Vegas Paving

DOT # 191949

Address: 4420 S. Decatur

Truck Number: 192364

Las Vegas, NV 89103

Phone Number: (702) 353-4355

I certify no hazardous waste or other regulated substance was knowingly introduced to the waste while in my custody. The waste transported in this vehicle is the waste identified above, to the best of my knowledge.

[Signature]
Name of Authorized Agent

Signature

10-6-10
Date Delivered

DISPOSAL SITE INFORMATION

Site Name: Apex Regional Landfill

Phone No. (702) 599-5920

Address: 13550 U.S. Hwy 93 Las Vegas, NV

I hereby acknowledge receipt of the above described materials

Juan Moreno
Name (Print or Type)

Juan Moreno
Signature

10-6-10
Date Received

81 Environmental Tech
13550 N Highway 93
Las Vegas, NV 89165

Ticket Type: INBOUND INVOICE

Ticket Number: 1830
Date: 10/06/2010
Time In: 7:12 am
Time Out: 7:42 am

Customer: 001011 - NGE, LLC c/o Northgate Environ Mgmt

Vehicle/Container: 192346
Contract: Northgate Env. On Site Soils 3825 11
Comment: 3825-10-11244

Gross Weight: 87,180 LB Scale In
Tare Weight: 37,020 LB Scale Out
Net Weight: 50160 LB
Net Tons: 25.08

BOL: 11924

Origin	Yards	Material	Billing	Quantity
Not Applicable	0.00 YD	SW CONTAMINATED SOIL	25.08	TN

Driver: 

Weighmaster: 

IN - walkera OUT - MORENOJ

Indemnification. Customer agrees, by signature above, to indemnify, hold harmless, and defend Republic Services, Inc., its subsidiaries, affiliates, employees, officers and directors from and against any and all liabilities, claims, penalties, forfeitures, suits and the costs and expenses incident thereto, including costs of defense, settlement, and reasonable attorney's fees, which may be incurred, as a result of death or injuries to any person, or damage to any property, contamination of or adverse effects on the environment, caused in whole or in part by the Customer, its employees, or subcontractors in disposing waste at this Facility. In the event Customer delivers Unacceptable Waste (as determined by Republic) Customer agrees to assume all expenses and obligations with the removal and/or resolution of any effects caused by the delivery of such Unacceptable Waste.

Indemnización. Cliente acuerda indemnizar, mantener inmune, y defender Republic Services, Inc., sus subsidiarios, compañías, divisiones, empleados, oficiales y directores contra de cualquiera y de todas responsabilidades, demandas, penas, pérdidas, juicios, pleitos y los costos incidente además, incluyendo costos de defensa, de acuerdo judicial, y de honorarios razonables del abogado, que pueden ser incurridos en, o como resultado de, la muerte o herida personal a cualquier persona, o daños a cualquier característica, propiedad, contaminación de la tierra o efectos ilícitos en esta Facilidad, causado entero o en parte por el cliente, sus empleados, o sus subcontratistas en botar basura en esta Facilidad. En el caso que el Cliente entrega, bota, basura (según lo determinado por Republic) en este Establecimiento basura inaceptable en los reglamentos de este Establecimiento, el Cliente se compromete asumir todos los costos y obligaciones con el retiro y/o la resolución de cualquier dano(s) causado por la entrega de tal basura inaceptable.



NON-HAZARDOUS WASTE MANIFEST

MANIFEST # 11924

GENERATOR INFORMATION

Generator Name: Tronox LLC

Address: P.O. Box 55

City: Henderson County: Clark

State: NV Zip: 89009

Site Location (if different): 560 W. Lake Mead
Henderson, NV 89015 (702) 592-7727

CUSTOMER/BILLING INFORMATION

Billing Name: NGE LLC c/o Northgate Environment Management

Address: 300 Frank Ogawa Plaza, Ste 510

City: Oakland County: Alameda

State: CA Zip: 94612

Republic Services Approval #	Description of Waste	Volume/Weight	Expiration Date	Container Type
38251011244	Soil for disposal		12-31-2011	Tractor with Dump Trailer(s)
	RZ-_____#_____	25.08 TN		

*Attach Additional Sheet if necessary

I hereby certify that the above-described materials are non-hazardous wastes as defined by 40 CFR 261 or any applicable state law. Further, that the above named materials are properly classified, described, packaged, marked and labeled, and are in proper condition for transportation according to the applicable regulations of the Department of Transportation.

Susan Crowley
Generator/Authorized Agent Name

Tom Crowley
Signature

Date Shipped

TRANSPORTER INFORMATION

Transporter Name: Las Vegas Paving

DOT # 191949

Address: 4420 S. Decatur

Truck Number: 192346

Las Vegas, NV 89103

Phone Number: (702) 353-4355

I certify no hazardous waste or other regulated substance was knowingly introduced to the waste while in my custody. The waste transported in this vehicle is the waste identified above, to the best of my knowledge.

Bernard
Name of Authorized Agent

Signature

Date Delivered

10/6/10

DISPOSAL SITE INFORMATION

Site Name: Apex Regional Landfill

Phone No. (702) 599-5920

Address: 13550 U.S. Hwy 93 Las Vegas, NV

I hereby acknowledge receipt of the above described materials.

Juan Moreno
Name (Print or Type)

Juan Moreno
Signature

Date Received

10-6-10

81 Environmental Tech
13550 N Highway 93
Las Vegas, NV 89165

Ticket Type: INBOUND INVOICE

Ticket Number: 1832
Date: 10/06/2010
Time In: 9:30 am
Time Out: 9:51 am

Customer: 001011 - NGE, LLC c/o Northgate Environ Mgmt

Vehicle/Container: 192391
Contract: Northgate Env. On Site Soils 3825 11
Comment: 3825-10-11244

Gross Weight: 82,120 LB Scale In
Tare Weight: 39,020 LB Scale Out
Net Weight: 43100 LB
Net Tons: 21.55

Manifest: 11926

Origin	Yards	Material	Billing Quantity
Not Applicable	0.00 YD	SW CONTAMINATED SOIL	21.55 TN

Driver: 

Weighmaster: 

IN - walkera OUT - GUILFDE

Indemnification. Customer agrees, by signature above, to indemnify, hold harmless, and defend Republic Services, Inc., its subsidiaries, affiliates, employees, officers and directors from and against any and all liabilities, claims, penalties, forfeitures, suits and the costs and expenses incident thereto, including costs of defense, settlement, and reasonable attorney's fees, which may be incurred, as a result of death or injuries to any person, or damage to any property, contamination of or adverse effects on the environment, caused in whole or in part by the Customer, its employees, or subcontractors in disposing waste at this Facility. In the event Customer delivers Unacceptable Waste (as determined by Republic) Customer agrees to assume all expenses and obligations with the removal and/or resolution of any effects caused by the delivery of such Unacceptable Waste.

Indemnización. Cliente acuerda indemnizar, mantener inmune, y defender Republic Services, Inc., sus subsidiarios, compañías, divisiones, empleados, oficiales y directores contra de cualquiera y de todas responsabilidades, demandas, penas, pérdidas, juicios, pleitos y los costos incidente además, incluyendo costos de defensa, de acuerdo judicial, y de honorarios razonables del abogado, que pueden ser incurridos en, o como resultado de, la muerte o herida personal a cualquier persona, o daños a cualquier característica, propiedad, contaminación de la tierra o efectos ilícitos en esta Facilidad, causado entero o en parte por el cliente, sus empleados, o sus subcontratistas en botar basura en esta Facilidad. En el caso que el Cliente entrega, bota, basura (según lo determinado por Republic) en este Establecimiento basura inaceptable en los reglamentos de este Establecimiento, el Cliente se compromete asumir todos los costos y obligaciones con el retiro y/o la resolución de cualquier dano(s) causado por la entrega de tal basura inaceptable.



NON-HAZARDOUS WASTE MANIFEST

MANIFEST # 11926

GENERATOR INFORMATION

Generator Name: Tronox LLC
Address: P.O. Box 55
City: Henderson County: Clark
State: NV Zip: 89009
Site Location (if different): 560 W. Lake Mead
Henderson, NV 89015 (702) 592-7727

CUSTOMER/BILLING INFORMATION

Billing Name: NGE LLC c/o Northgate Environment Management
Address: 300 Frank Ogawa Plaza, Ste 510
City: Oakland County: Alameda
State: CA Zip: 94612

Table with 5 columns: Republic Services Approval #, Description of Waste, Volume/Weight, Expiration Date, Container Type. Row 1: 38251011244, Soil for disposal, 21.55 TN, 12-31-2011, Tractor with Dump Trailer(s).

*Attach Additional Sheet if necessary

I hereby certify that the above-described materials are non-hazardous wastes as defined by 40 CFR 261 or any applicable state law. Further, that the above named materials are properly classified, described, packaged, marked and labeled, and are in proper condition for transportation according to the applicable regulations of the Department of Transportation.

Susan Crowley (Signature)
Generator/Authorized Agent Name Signature Date Shipped

TRANSPORTER INFORMATION

Transporter Name: Las Vegas Paving DOT # 191949
Address: 4420 S. Decatur Truck Number: 192391
Las Vegas, NV 89103 Phone Number: (702) 353-4355

I certify no hazardous waste or other regulated substance was knowingly introduced to the waste while in my custody. The waste transported in this vehicle is the waste identified above, to the best of my knowledge.

Henson (Signature) 10-6-10
Name of Authorized Agent Signature Date Delivered

DISPOSAL SITE INFORMATION

Site Name: Apex Regional Landfill Phone No. (702) 599-5920
Address: 13550 U.S. Hwy 93 Las Vegas, NV

I hereby acknowledge receipt of the above described materials
Ariel Drake-Walker (Signature) 10/6/10
Name (Print or Type) Signature Date Received

81 Environmental Tech
13550 N Highway 93
Las Vegas, NV 89165

Ticket Type: INBOUND INVOICE

Ticket Number: 1833
Date: 10/06/2010
Time In: 9:30 am
Time Out: 9:56 am

Customer: 001011 - NGE, LLC c/o Northgate Environ Mgmt

Vehicle/Container: 192346
Contract: Northgate Env. On Site Soils 3825 11
Comment: 3825-10-11244

Gross Weight: 85,640 LB Scale In
Tare Weight: 36,760 LB Manual Out
Net Weight: 48880 LB
Net Tons: 24.44

Manifest: 11928

Origin	Yards	Material	Billing	Quantity
Not Applicable	0.00 YD	SW CONTAMINATED SOIL	24.44	TN

Driver: _____

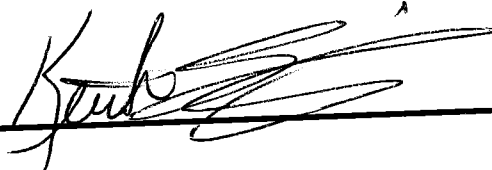

Weighmaster: _____

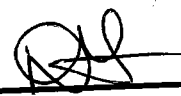

IN - walkera OUT - GUILFDE

Indemnification. Customer agrees, by signature above, to indemnify, hold harmless, and defend Republic Services, Inc., its subsidiaries, affiliates, employees, officers and directors from and against any and all liabilities, claims, penalties, forfeitures, suits and the costs and expenses incident thereto, including costs of defense, settlement, and reasonable attorney's fees, which may be incurred, as a result of death or injuries to any person, or damage to any property, contamination of or adverse effects on the environment, caused in whole or in part by the Customer, its employees, or subcontractors in disposing waste at this Facility. In the event Customer delivers Unacceptable Waste (as determined by Republic) Customer agrees to assume all expenses and obligations with the removal and/or resolution of any effects caused by the delivery of such Unacceptable Waste.

Indemnización. Cliente acuerda indemnizar, mantener inmune, y defender Republic Services, Inc., sus subsidiarios, compañías, divisiones, empleados, oficiales y directores contra de cualquiera y de todas responsabilidades, demandas, penas, pérdidas, juicios, pleitos y los costos incidente además, incluyendo costos de defensa, de acuerdo judicial, y de honorarios razonables del abogado, que pueden ser incurridos en, o como resultado de, la muerte o herida personal a cualquier persona, o daños a cualquier característica, propiedad, contaminación de la tierra o efectos ilícitos en esta Facilidad, causado entero o en parte por el cliente, sus empleados, o sus subcontratistas en botar basura en esta Facilidad. En el caso que el Cliente entrega, bota, basura (según lo determinado por Republic) en este Establecimiento basura inaceptable en los reglamentos de este Establecimiento, el Cliente se compromete asumir todos los costos y obligaciones con el retiro y/o la resolución de cualquier dano(s) causado por la entrega de tal basura inaceptable.



NON-HAZARDOUS WASTE MANIFEST

MANIFEST # 11928

GENERATOR INFORMATION

Generator Name: Tronox LLC
 Address: P.O. Box 55
 City: Henderson County: Clark
 State: NV Zip: 89009
 Site Location (if different): 560 W. Lake Mead
Henderson, NV 89015 (702) 592-7727

CUSTOMER/BILLING INFORMATION

Billing Name: NGE LLC c/o Northgate Environment Management
 Address: 300 Frank Ogawa Plaza, Ste 510
 City: Oakland County: Alameda
 State: CA Zip: 94612

Republic Services Approval #	Description of Waste	Volume/Weight	Expiration Date	Container Type
38251011244	Soil for disposal		12-31-2011	Tractor with Dump Trailer(s)
	RZ- _____ # _____	<u>24.44 TN</u>		

*Attach Additional Sheet if necessary

I hereby certify that the above-described materials are non-hazardous wastes as defined by 40 CFR 261 or any applicable state law. Further, that the above named materials are properly classified, described, packaged, marked and labeled, and are in proper condition for transportation according to the applicable regulations of the Department of Transportation.

Susan Crowley [Signature]
 Generator/Authorized Agent Name Signature Date Shipped

TRANSPORTER INFORMATION

Transporter Name: Las Vegas Paving DOT # 191949
 Address: 4420 S. Decatur Truck Number: 192346
Las Vegas, NV 89103 Phone Number: (702) 353-4355

I certify no hazardous waste or other regulated substance was knowingly introduced to the waste while in my custody. The waste transported in this vehicle is the waste identified above, to the best of my knowledge.

[Signature] 10-6-10
 Name of Authorized Agent Signature Date Delivered

DISPOSAL SITE INFORMATION

Site Name: Apex Regional Landfill Phone No. (702) 599-5920
 Address: 13550 U.S. Hwy 93 Las Vegas, NV

I hereby acknowledge receipt of the above described materials
Aria Drake-Walker [Signature] 10/6/10
 Name (Print or Type) Signature Date Received

81 Environmental Tech
13550 N Highway 93
Las Vegas, NV 89165

Ticket Type: INBOUND INVOICE

Ticket Number: 1834
Date: 10/06/2010
Time In: 9:31 am
Time Out: 9:57 am

Customer: 001011 - NGE, LLC c/o Northgate Environ Mgmt

Vehicle/Container: 192364
Contract: Northgate Env. On Site Soils 3825 11
Comment: 3825-10-11244

Gross Weight: 80,800 LB Scale In
Tare Weight: 38,280 LB Scale Out
Net Weight: 42520 LB
Net Tons: 21.26

BOL: 11927

Origin	Yards	Material	Billing Quantity
Not Applicable	0.00 YD	SW CONTAMINATED SOIL	21.26 TN

Driver: _____

Weighmaster: _____

IN - walkera OUT - GUILFDE

Indemnification. Customer agrees, by signature above, to indemnify, hold harmless, and defend Republic Services, Inc., its subsidiaries, affiliates, employees, officers and directors from and against any and all liabilities, claims, penalties, forfeitures, suits and the costs and expenses incident thereto, including costs of defense, settlement, and reasonable attorney's fees, which may be incurred, as a result of death or injuries to any person, or damage to any property, contamination of or adverse effects on the environment, caused in whole or in part by the Customer, its employees, or subcontractors in disposing waste at this Facility. In the event Customer delivers Unacceptable Waste (as determined by Republic) Customer agrees to assume all expenses and obligations with the removal and/or resolution of any effects caused by the delivery of such Unacceptable Waste.

Indemnización. Cliente acuerda indemnizar, mantener inmune, y defender Republic Services, Inc., sus subsidiarios, compañías, divisiones, empleados, oficiales y directores contra de cualquiera y de todas responsabilidades, demandas, penas, pérdidas, juicios, pleitos y los costos incidente además, incluyendo costos de defensa, de acuerdo judicial, y de honorarios razonables del abogado, que pueden ser incurridos en, o como resultado de, la muerte o herida personal a cualquier persona, o daños a cualquier característica, propiedad, contaminación de la tierra o efectos ilícitos en esta Facilidad, causado entero o en parte por el cliente, sus empleados, o sus subcontratistas en botar basura en esta Facilidad. En el caso que el Cliente entrega, bota, basura (según lo determinado por Republic) en este Establecimiento basura inaceptable en los reglamentos de este Establecimiento, el Cliente se compromete asumir todos los costos y obligaciones con el retiro y/o la resolución de cualquier dano(s) causado por la entrega de tal basura inaceptable.



NON-HAZARDOUS WASTE MANIFEST

MANIFEST # 11927

GENERATOR INFORMATION

Generator Name: Tronox LLC
Address: P.O. Box 55
City: Henderson County: Clark
State: NV Zip: 89009
Site Location (if different): 560 W. Lake Mead
Henderson, NV 89015 (702) 592-7727

CUSTOMER/BILLING INFORMATION

Billing Name: NGE LLC c/o Northgate Environment Management
Address: 300 Frank Ogawa Plaza, Ste 510
City: Oakland County: Alameda
State: CA Zip: 94612

Table with 5 columns: Republic Services Approval #, Description of Waste, Volume/Weight, Expiration Date, Container Type. Row 1: 38251011244, Soil for disposal, 21.26 TN, 12-31-2011, Tractor with Dump Trailer(s).

*Attach Additional Sheet if necessary

I hereby certify that the above-described materials are non-hazardous wastes as defined by 40 CFR 261 or any applicable state law. Further, that the above named materials are properly classified, described, packaged, marked and labeled, and are in proper condition for transportation according to the applicable regulations of the Department of Transportation.

Susan Crowley
Generator/Authorized Agent Name Signature Date Shipped

TRANSPORTER INFORMATION

Transporter Name: Las Vegas Paving DOT # 191949
Address: 4420 S. Decatur Truck Number: 192364
Las Vegas, NV 89103 Phone Number: (702) 353-4355

I certify no hazardous waste or other regulated substance was knowingly introduced to the waste while in my custody. The waste transported in this vehicle is the waste identified above, to the best of my knowledge.

Name of Authorized Agent Signature Date Delivered 10-6-10

DISPOSAL SITE INFORMATION

Site Name: Apex Regional Landfill Phone No. (702) 599-5920
Address: 13550 U.S. Hwy 93 Las Vegas, NV

I hereby acknowledge receipt of the above described materials
Name (Print or Type) Signature Date Received 10/6/10

81 Environmental Tech
13550 N Highway 93
Las Vegas, NV 89165

Ticket Type: INBOUND INVOICE

Ticket Number: 1836
Date: 10/06/2010
Time In: 11:39 am
Time Out: 12:01 pm

Customer: 001011 - NGE, LLC c/o Northgate Environ Mgmt

Vehicle/Container: 192391
Contract: Northgate Env. On Site Soils 3825 11
Comment: 3825-10-11244

Gross Weight: 89,860 LB Scale In
Tare Weight: 39,000 LB Manual Out
Net Weight: 50860 LB
Net Tons: 25.43

BOL: 11929

Origin	Yards	Material	Billing Quantity
Not Applicable	0.00 YD	SW CONTAMINATED SOIL	25.43 TN

Driver: 

Weighmaster: 

IN - GUILFDE OUT - walkera

Indemnification. Customer agrees, by signature above, to indemnify, hold harmless, and defend Republic Services, Inc., its subsidiaries, affiliates, employees, officers and directors from and against any and all liabilities, claims, penalties, forfeitures, suits and the costs and expenses incident thereto, including costs of defense, settlement, and reasonable attorney's fees, which may be incurred, as a result of death or injuries to any person, or damage to any property, contamination of or adverse effects on the environment, caused in whole or in part by the Customer, its employees, or subcontractors in disposing waste at this Facility. In the event Customer delivers Unacceptable Waste (as determined by Republic) Customer agrees to assume all expenses and obligations with the removal and/or resolution of any effects caused by the delivery of such Unacceptable Waste.

Indemnización. Cliente acuerda indemnizar, mantener inmune, y defender Republic Services, Inc., sus subsidiarios, compañías, divisiones, empleados, oficiales y directores contra de cualquiera y de todas responsabilidades, demandas, penas, pérdidas, juicios, pleitos y los costos incidente además, incluyendo costos de defensa, de acuerdo judicial, y de honorarios razonables del abogado, que pueden ser incurridos en, o como resultado de, la muerte o herida personal a cualquier persona, o daños a cualquier característica, propiedad, contaminación de la tierra o efectos ilícitos en esta Facilidad, causado entero o en parte por el cliente, sus empleados, o sus subcontratistas en botar basura en esta Facilidad. En el caso que el Cliente entrega, bota, basura (según lo determinado por Republic) en este Establecimiento basura inaceptable en los reglamentos de este Establecimiento, el Cliente se compromete asumir todos los costos y obligaciones con el retiro y/o la resolución de cualquier dano(s) causado por la entrega de tal basura inaceptable.



NON-HAZARDOUS WASTE MANIFEST

MANIFEST # 11929

GENERATOR INFORMATION

Generator Name: Tronox LLC
 Address: P.O. Box 55
 City: Henderson County: Clark
 State: NV Zip: 89009
 Site Location (if different): 560 W. Lake Mead
Henderson, NV 89015 (702) 592-7727

CUSTOMER/BILLING INFORMATION

Billing Name: NGE LLC c/o Northgate Environment Management
 Address: 300 Frank Ogawa Plaza, Ste 510
 City: Oakland County: Alameda
 State: CA Zip: 94612

Republic Services Approval #	Description of Waste	Volume/Weight	Expiration Date	Container Type
38251011244	Soil for disposal		12-31-2011	Tractor with Dump Trailer(s)
	RZ- _____ # _____	25.43 TN		

*Attach Additional Sheet if necessary

I hereby certify that the above-described materials are non-hazardous wastes as defined by 40 CFR 261 or any applicable state law. Further, that the above named materials are properly classified, described, packaged, marked and labeled, and are in proper condition for transportation according to the applicable regulations of the Department of Transportation.

Susan Crowley *Susan Crowley*
 Generator/Authorized Agent Name Signature Date Shipped

TRANSPORTER INFORMATION

Transporter Name: Las Vegas Paving DOT # 191949
 Address: 4420 S. Decatur Truck Number: 192391
Las Vegas, NV 89103 Phone Number: (702) 353-4355

I certify no hazardous waste or other regulated substance was knowingly introduced to the waste while in my custody. The waste transported in this vehicle is the waste identified above, to the best of my knowledge.

Simon 10-6-10
 Name of Authorized Agent Signature Date Delivered

DISPOSAL SITE INFORMATION

Site Name: Apex Regional Landfill Phone No. (702) 599-5920
 Address: 13550 U.S. Hwy 93 Las Vegas, NV

I hereby acknowledge receipt of the above described materials
Oral Drake-Walker *Oral Drake-Walker* 10/6/10
 Name (Print or Type) Signature Date Received

81 Environmental Tech
13550 N Highway 93
Las Vegas, NV 89165

Ticket Type: INBOUND INVOICE

Ticket Number: 1837
Date: 10/06/2010
Time In: 11:40 am
Time Out: 12:03 pm

Customer: 001011 - NGE, LLC c/o Northgate Environ Mgmt

Vehicle/Container: 192346
Contract: Northgate Env. On Site Soils 3825 11
Comment: 3925-10-11244

Gross Weight: 84,020 LB Scale In
Tare Weight: 36,620 LB Manual Out
Net Weight: 47400 LB
Net Tons: 23.70

BOL: 11930

Origin	Yards	Material	Billing Quantity
Not Applicable	0.00 YD	SW CONTAMINATED SOIL	23.70 TN

Driver:

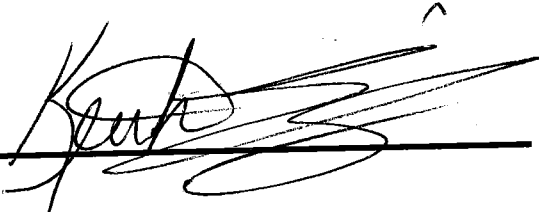

Weighmaster:



IN - GUILFDE OUT - walkera

Indemnification. Customer agrees, by signature above, to indemnify, hold harmless, and defend Republic Services, Inc., its subsidiaries, affiliates, employees, officers and directors from and against any and all liabilities, claims, penalties, forfeitures, suits and the costs and expenses incident thereto, including costs of defense, settlement, and reasonable attorney's fees, which may be incurred, as a result of death or injuries to any person, or damage to any property, contamination of or adverse effects on the environment, caused in whole or in part by the Customer, its employees, or subcontractors in disposing waste at this Facility. In the event Customer delivers Unacceptable Waste (as determined by Republic) Customer agrees to assume all expenses and obligations with the removal and/or resolution of any effects caused by the delivery of such Unacceptable Waste.

Indemnización. Cliente acuerda indemnizar, mantener inmune, y defender Republic Services, Inc., sus subsidiarios, compañías, divisiones, empleados, oficiales y directores contra de cualquiera y de todas responsabilidades, demandas, penas, pérdidas, juicios, pleitos y los costos incidente además, incluyendo costos de defensa, de acuerdo judicial, y de honorarios razonables del abogado, que pueden ser incurridos en, o como resultado de, la muerte o herida personal a cualquier persona, o daños a cualquier característica, propiedad, contaminación de la tierra o efectos ilícitos en esta Facilidad, causado entero o en parte por el cliente, sus empleados, o sus subcontratistas en botar basura en esta Facilidad. En el caso que el Cliente entrega, bota, basura (según lo determinado por Republic) en este Establecimiento basura inaceptable en los reglamentos de este Establecimiento, el Cliente se compromete asumir todos los costos y obligaciones con el retiro y/o la resolución de cualquier dano(s) causado por la entrega de tal basura inaceptable.



NON-HAZARDOUS WASTE MANIFEST

MANIFEST # 11930

GENERATOR INFORMATION

Generator Name: Tronox LLC

Address: P.O. Box 55

City: Henderson County: Clark

State: NV Zip: 89009

Site Location (if different): 560 W. Lake Mead

Henderson, NV 89015 (702) 592-7727

CUSTOMER/BILLING INFORMATION

Billing Name: NGE LLC c/o Northgate Environment Management

Address: 300 Frank Ogawa Plaza, Ste 510

City: Oakland County: Alameda

State: CA Zip: 94612

Republic Services Approval #	Description of Waste	Volume/Weight	Expiration Date	Container Type
38251011244	Soil for disposal		12-31-2011	Tractor with Dump Trailer(s)
	RZ- _____ # _____	23.70		

*Attach Additional Sheet if necessary

I hereby certify that the above-described materials are non-hazardous wastes as defined by 40 CFR 261 or any applicable state law. Further, that the above named materials are properly classified, described, packaged, marked and labeled, and are in proper condition for transportation according to the applicable regulations of the Department of Transportation.

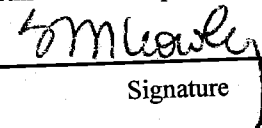
Susan Crowley  _____
 Generator/Authorized Agent Name Signature Date Shipped

TRANSPORTER INFORMATION

Transporter Name: Las Vegas Paving

DOT # 191949

Address: 4420 S. Decatur

Truck Number: 192346

Las Vegas, NV 89103

Phone Number: (702) 353-4355

I certify no hazardous waste or other regulated substance was knowingly introduced to the waste while in my custody. The waste transported in this vehicle is the waste identified above, to the best of my knowledge.

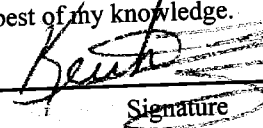
 Name of Authorized Agent  10-6-10
 Signature Date Delivered

DISPOSAL SITE INFORMATION

Site Name: Apex Regional Landfill

Phone No. (702) 599-5920

Address: 13550 U.S. Hwy 93 Las Vegas, NV

I hereby acknowledge receipt of the above described materials

Chris D. Walker  _____
 Name (Print or Type) Signature Date Received 10/6/10

81 Environmental Tech
13550 N Highway 93
Las Vegas, NV 89165

Ticket Type: INBOUND INVOICE

Ticket Number: 1838
Date: 10/06/2010
Time In: 11:45 am
Time Out: 12:07 pm

Customer: 001011 - NGE, LLC c/o Northgate Environ Mgmt

Vehicle/Container: 192364
Contract: Northgate Env. On Site Soils 3825 11
Comment: 3825-10-11244

Gross Weight: 89,600 LB Scale In
Tare Weight: 38,220 LB Scale Out
Net Weight: 51380 LB
Net Tons: 25.69

BOL: 11931

Origin	Yards	Material	Billing	Quantity
Not Applicable	0.00 YD	SW CONTAMINATED SOIL	25.69	TN

Driver: _____

Weighmaster: _____

IN - GUILFDE OUT - walkera

Indemnification. Customer agrees, by signature above, to indemnify, hold harmless, and defend Republic Services, Inc., its subsidiaries, affiliates, employees, officers and directors from and against any and all liabilities, claims, penalties, forfeitures, suits and the costs and expenses incident thereto, including costs of defense, settlement, and reasonable attorney's fees, which may be incurred, as a result of death or injuries to any person, or damage to any property, contamination of or adverse effects on the environment, caused in whole or in part by the Customer, its employees, or subcontractors in disposing waste at this Facility. In the event Customer delivers Unacceptable Waste (as determined by Republic) Customer agrees to assume all expenses and obligations with the removal and/or resolution of any effects caused by the delivery of such Unacceptable Waste.

Indemnización. Cliente acuerda indemnizar, mantener inmune, y defender Republic Services, Inc., sus subsidiarios, compañías, divisiones, empleados, oficiales y directores contra de cualquiera y de todas responsabilidades, demandas, penas, pérdidas, juicios, pleitos y los costos incidente además, incluyendo costos de defensa, de acuerdo judicial, y de honorarios razonables del abogado, que pueden ser incurridos en, o como resultado de, la muerte o herida personal a cualquier persona, o daños a cualquier característica, propiedad, contaminación de la tierra o efectos ilícitos en esta Facilidad, causado entero o en parte por el cliente, sus empleados, o sus subcontratistas en botar basura en esta Facilidad. En el caso que el Cliente entrega, bota, basura (según lo determinado por Republic) en este Establecimiento basura inaceptable en los reglamentos de este Establecimiento, el Cliente se compromete asumir todos los costos y obligaciones con el retiro y/o la resolución de cualquier dano(s) causado por la entrega de tal basura inaceptable.



NON-HAZARDOUS WASTE MANIFEST

MANIFEST # 11931

GENERATOR INFORMATION

Generator Name: Tronox LLC

Address: P.O. Box 55

City: Henderson County: Clark

State: NV Zip: 89009

Site Location (if different): 560 W. Lake Mead

Henderson, NV 89015 (702) 592-7727

CUSTOMER/BILLING INFORMATION

Billing Name: NGE LLC c/o Northgate Environment Management

Address: 300 Frank Ogawa Plaza, Ste 510

City: Oakland County: Alameda

State: CA Zip: 94612

Republic Services Approval #	Description of Waste	Volume/Weight	Expiration Date	Container Type
38251011244	Soil for disposal		12-31-2011	Tractor with Dump Trailer(s)
	RZ- _____ # _____	85.69 TN		

*Attach Additional Sheet if necessary

I hereby certify that the above-described materials are non-hazardous wastes as defined by 40 CFR 261 or any applicable state law. Further, that the above named materials are properly classified, described, packaged, marked and labeled, and are in proper condition for transportation according to the applicable regulations of the Department of Transportation.

Susan Crowley
Generator/Authorized Agent Name

Susan Crowley
Signature

10
Date Shipped

TRANSPORTER INFORMATION

Transporter Name: Las Vegas Paving

DOT # 191949

Address: 4420 S. Decatur

Truck Number: 192364

Las Vegas, NV 89103

Phone Number: (702) 353-4355

I certify no hazardous waste or other regulated substance was knowingly introduced to the waste while in my custody. The waste transported in this vehicle is the waste identified above, to the best of my knowledge.

[Signature]
Name of Authorized Agent

10-6-10
Signature

Date Delivered

DISPOSAL SITE INFORMATION

Site Name: Apex Regional Landfill

Phone No. (702) 599-5920

Address: 13550 U.S. Hwy 93 Las Vegas, NV

I hereby acknowledge receipt of the above described materials

Orin Drake Walker
Name (Print or Type)

Orin Drake Walker
Signature

10/6/10
Date Received

81 Environmental Tech
13550 N Highway 93
Las Vegas, NV 89165

Ticket Type: INBOUND INVOICE

Ticket Number: 1841
Date: 10/06/2010
Time In: 7:43 pm
Time Out: 8:04 pm

Customer: 001011 - NGE, LLC c/o Northgate Environ Mgmt

Vehicle/Container: 84598P
Contract: Northgate Env. On Site Soils 3825 11
Comment: 3825 10 11244

Gross Weight: 121,180 LB Manual In
Tare Weight: 52,080 LB Manual Out
Net Weight: 69100 LB
Net Tons: 34.55

BOL: 11932

Origin	Yards	Material	Billing	Quantity
Not Applicable	0.00 YD	SW CONTAMINATED SOIL	34.55	TN

Driver: _____

Weighmaster: _____

IN - SMITHJ OUT - CARTERJ

Indemnification. Customer agrees, by signature above, to indemnify, hold harmless, and defend Republic Services, Inc., its subsidiaries, affiliates, employees, officers and directors from and against any and all liabilities, claims, penalties, forfeitures, suits and the costs and expenses incident thereto, including costs of defense, settlement, and reasonable attorney's fees, which may be incurred, as a result of death or injuries to any person, or damage to any property, contamination of or adverse effects on the environment, caused in whole or in part by the Customer, its employees, or subcontractors in disposing waste at this Facility. In the event Customer delivers Unacceptable Waste (as determined by Republic) Customer agrees to assume all expenses and obligations with the removal and/or resolution of any effects caused by the delivery of such Unacceptable Waste.

Indemnización. Cliente acuerda indemnizar, mantener inmune, y defender Republic Services, Inc., sus subsidiarios, compañías, divisiones, empleados, oficiales y directores contra de cualquiera y de todas responsabilidades, demandas, penas, pérdidas, juicios, pleitos y los costos incidente además, incluyendo costos de defensa, de acuerdo judicial, y de honorarios razonables del abogado, que pueden ser incurridos en, o como resultado de, la muerte o herida personal a cualquier persona, o daños a cualquier característica, propiedad, contaminación de la tierra o efectos ilícitos en esta Facilidad, causado entero o en parte por el cliente, sus empleados, o sus subcontratistas en botar basura en esta Facilidad. En el caso que el Cliente entrega, bota, basura (según lo determinado por Republic) en este Establecimiento basura inaceptable en los reglamentos de este Establecimiento, el Cliente se compromete asumir todos los costos y obligaciones con el retiro y/o la resolución de cualquier dano(s) causado por la entrega de tal basura inaceptable.



NON-HAZARDOUS WASTE MANIFEST

MANIFEST # 11932

GENERATOR INFORMATION

Generator Name: Tronox LLCAddress: P.O. Box 55City: Henderson County: ClarkState: NV Zip: 89009Site Location (if different): 560 W. Lake MeadHenderson, NV 89015 (702) 592-7727

CUSTOMER/BILLING INFORMATION

Billing Name: NGE LLC c/o Northgate Environment ManagementAddress: 300 Frank Ogawa Plaza, Ste 510City: Oakland County: AlamedaState: CA Zip: 94612

Republic Services Approval #	Description of Waste	Volume/Weight	Expiration Date	Container Type
38251011244	Soil for disposal	34.55 TN	12-31-2011	Tractor with Dump Trailer(s)
	RZ- #			

*Attach Additional Sheet if necessary

I hereby certify that the above-described materials are non-hazardous wastes as defined by 40 CFR 261 or any applicable state law. Further, that the above named materials are properly classified, described, packaged, marked and labeled, and are in proper condition for transportation according to the applicable regulations of the Department of Transportation.

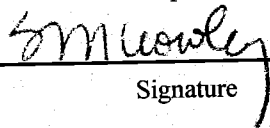
Susan Crowley 
 Generator/Authorized Agent Name Signature Date Shipped

TRANSPORTER INFORMATION

Transporter Name: Las Vegas PavingDOT # 191949Address: 4420 S. DecaturTruck Number: 28Las Vegas, NV 89103Phone Number: (702) 353-4355

I certify no hazardous waste or other regulated substance was knowingly introduced to the waste while in my custody. The waste transported in this vehicle is the waste identified above, to the best of my knowledge.

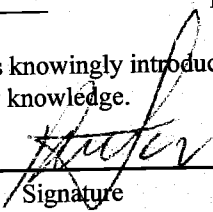
KALIKS 
 Name of Authorized Agent Signature Date Delivered 10-6-10

DISPOSAL SITE INFORMATION

Site Name: Apex Regional LandfillPhone No. (702) 599-5920Address: 13550 U.S. Hwy 93 Las Vegas, NV

I hereby acknowledge receipt of the above described materials

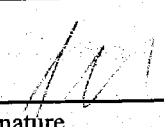
JASON CARTER 
 Name (Print or Type) Signature Date Received 10/6/10

81 Environmental Tech
13550 N Highway 93
Las Vegas, NV 89165

Ticket Type: INBOUND INVOICE

Ticket Number: 1842
Date: 10/06/2010
Time In: 7:53 pm
Time Out: 8:15 pm

Customer: 001011 - NGE, LLC c/o Northgate Environ Mgmt

Vehicle/Container: 81496P
Contract: Northgate Env. On Site Soils 3825 11
Comment: 3825 10 11244

Gross Weight: 118,820 LB Manual In
Tare Weight: 50,660 LB Manual Out
Net Weight: 68160 LB
Net Tons: 34.08

BOL: 11933

Origin	Yards	Material	Billing	Quantity
Not Applicable	0.00 YD	SW CONTAMINATED SOIL	34.08	TN

Driver: 

Weighmaster: 

IN - SMITHJ OUT - CARTERJ

Indemnification. Customer agrees, by signature above, to indemnify, hold harmless, and defend Republic Services, Inc., its subsidiaries, affiliates, employees, officers and directors from and against any and all liabilities, claims, penalties, forfeitures, suits and the costs and expenses incident thereto, including costs of defense, settlement, and reasonable attorney's fees, which may be incurred, as a result of death or injuries to any person, or damage to any property, contamination of or adverse effects on the environment, caused in whole or in part by the Customer, its employees, or subcontractors in disposing waste at this Facility. In the event Customer delivers Unacceptable Waste (as determined by Republic) Customer agrees to assume all expenses and obligations with the removal and/or resolution of any effects caused by the delivery of such Unacceptable Waste.

Indemnización. Cliente acuerda indemnizar, mantener inmune, y defender Republic Services, Inc., sus subsidiarios, compañías, divisiones, empleados, oficiales y directores contra de cualquiera y de todas responsabilidades, demandas, penas, pérdidas, juicios, pleitos y los costos incidente además, incluyendo costos de defensa, de acuerdo judicial, y de honorarios razonables del abogado, que pueden ser incurridos en, o como resultado de, la muerte o herida personal a cualquier persona, o daños a cualquier característica, propiedad, contaminación de la tierra o efectos ilícitos en esta Facilidad, causado entero o en parte por el cliente, sus empleados, o sus subcontratistas en botar basura en esta Facilidad. En el caso que el Cliente entrega, bota, basura (según lo determinado por Republic) en este Establecimiento basura inaceptable en los reglamentos de este Establecimiento, el Cliente se compromete asumir todos los costos y obligaciones con el retiro y/o la resolución de cualquier dano(s) causado por la entrega de tal basura inaceptable.



NON-HAZARDOUS WASTE MANIFEST

MANIFEST # 11933

GENERATOR INFORMATION

Generator Name: Tronox LLC

Address: P.O. Box 55

City: Henderson County: Clark

State: NV Zip: 89009

Site Location (if different): 560 W. Lake Mead

Henderson, NV 89015 (702) 592-7727

CUSTOMER/BILLING INFORMATION

Billing Name: NGE LLC c/o Northgate Environment Management

Address: 300 Frank Ogawa Plaza, Ste 510

City: Oakland County: Alameda

State: CA Zip: 94612

Republic Services Approval #	Description of Waste	Volume/Weight	Expiration Date	Container Type
38251011244	Soil for disposal	34.08 TN	12-31-2011	Tractor with Dump Trailer(s)
	RZ- _____ # _____			

*Attach Additional Sheet if necessary

I hereby certify that the above-described materials are non-hazardous wastes as defined by 40 CFR 261 or any applicable state law. Further, that the above named materials are properly classified, described, packaged, marked and labeled, and are in proper condition for transportation according to the applicable regulations of the Department of Transportation.

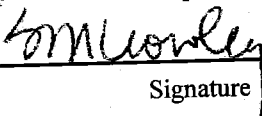
Susan Crowley 
 Generator/Authorized Agent Name Signature Date Shipped

TRANSPORTER INFORMATION

Transporter Name: Las Vegas Paving

DOT # 191949

Address: 4420 S. Decatur

Truck Number: 145

Las Vegas, NV 89103

Phone Number: (702) 353-4355

I certify no hazardous waste or other regulated substance was knowingly introduced to the waste while in my custody. The waste transported in this vehicle is the waste identified above, to the best of my knowledge.

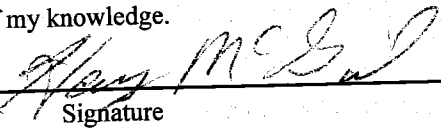
Harry M. B... 
 Name of Authorized Agent Signature Date Delivered 10-6-10

DISPOSAL SITE INFORMATION

Site Name: Apex Regional Landfill

Phone No. (702) 599-5920

Address: 13550 U.S. Hwy 93 Las Vegas, NV

I hereby acknowledge receipt of the above described materials

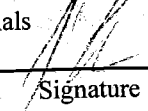
JASON CARTER 
 Name (Print or Type) Signature Date Received 10/6/10

81 Environmental Tech
13550 N Highway 93
Las Vegas, NV 89165

Ticket Type: INBOUND INVOICE

Ticket Number: 1843
Date: 10/06/2010
Time In: 7:57 pm
Time Out: 8:19 pm

Customer: 001011 - NGE, LLC c/o Northgate Environ Mgmt

Vehicle/Container: 81495P
Contract: Northgate Env. On Site Soils 3825 11
Comment: 3825 10 11244

Gross Weight: 119,760 LB Manual In
Tare Weight: 53,340 LB Manual Out
Net Weight: 66,420 LB
Net Tons: 33.21

BOL: 11934

Origin	Yards	Material	Billing	Quantity
Not Applicable	0.00 YD	SW CONTAMINATED SOIL	33.21	TN

Driver: _____

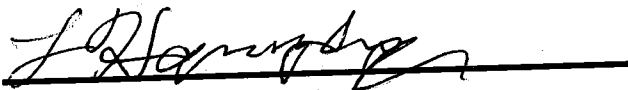

Weighmaster: _____

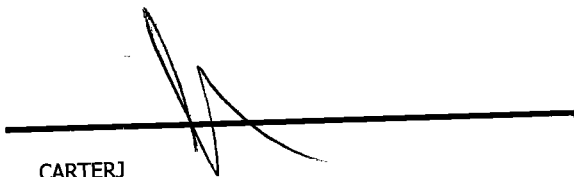

CARTERJ

Indemnification. Customer agrees, by signature above, to indemnify, hold harmless, and defend Republic Services, Inc., its subsidiaries, affiliates, employees, officers and directors from and against any and all liabilities, claims, penalties, forfeitures, suits and the costs and expenses incident thereto, including costs of defense, settlement, and reasonable attorney's fees, which may be incurred, as a result of death or injuries to any person, or damage to any property, contamination of or adverse effects on the environment, caused in whole or in part by the Customer, its employees, or subcontractors in disposing waste at this Facility. In the event Customer delivers Unacceptable Waste (as determined by Republic) Customer agrees to assume all expenses and obligations with the removal and/or resolution of any effects caused by the delivery of such Unacceptable Waste.

Indemnización. Cliente acuerda indemnizar, mantener inmune, y defender Republic Services, Inc., sus subsidiarios, compañías, divisiones, empleados, oficiales y directores contra de cualquiera y de todas responsabilidades, demandas, penas, pérdidas, juicios, pleitos y los costos incidente además, incluyendo costos de defensa, de acuerdo judicial, y de honorarios razonables del abogado, que pueden ser incurridos en, o como resultado de, la muerte o herida personal a cualquier persona, o daños a cualquier característica, propiedad, contaminación de la tierra o efectos ilícitos en esta Facilidad, causado entero o en parte por el cliente, sus empleados, o sus subcontratistas en botar basura en esta Facilidad. En el caso que el Cliente entrega, bota, basura (según lo determinado por Republic) en este Establecimiento basura inaceptable en los reglamentos de este Establecimiento, el Cliente se compromete asumir todos los costos y obligaciones con el retiro y/o la resolución de cualquier dano(s) causado por la entrega de tal basura inaceptable.



SR 40236

NON-HAZARDOUS WASTE MANIFEST

MANIFEST # 11934

GENERATOR INFORMATION

Generator Name: Tronox LLC

Address: P.O. Box 55

City: Henderson County: Clark

State: NV Zip: 89009

Site Location (if different): 560 W. Lake Mead

Henderson, NV 89015 (702) 592-7727

CUSTOMER/BILLING INFORMATION

Billing Name: NGE LLC c/o Northgate Environment Management

Address: 300 Frank Ogawa Plaza, Ste 510

City: Oakland County: Alameda

State: CA Zip: 94612

Republic Services Approval #	Description of Waste	Volume/Weight	Expiration Date	Container Type
38251011244	Soil for disposal	33.21 TN	12-31-2011	Tractor with Dump Trailer(s)
	RZ- _____ # _____			

*Attach Additional Sheet if necessary

I hereby certify that the above-described materials are non-hazardous wastes as defined by 40 CFR 261 or any applicable state law. Further, that the above named materials are properly classified, described, packaged, marked and labeled, and are in proper condition for transportation according to the applicable regulations of the Department of Transportation.

Susan Crowley
Generator/Authorized Agent Name

Susan Crowley
Signature

Date Shipped

TRANSPORTER INFORMATION

Transporter Name: Las Vegas Paving

DOT # 191949

Address: 4420 S. Decatur

Truck Number: 175

Las Vegas, NV 89103

Phone Number: (702) 353-4355

I certify no hazardous waste or other regulated substance was knowingly introduced to the waste while in my custody. The waste transported in this vehicle is the waste identified above, to the best of my knowledge.

Larry Harnsberger
Name of Authorized Agent

[Signature]
Signature

10-6-10
Date Delivered

DISPOSAL SITE INFORMATION

Site Name: Apex Regional Landfill

Phone No. (702) 599-5920

Address: 13550 U.S. Hwy 93 Las Vegas, NV

I hereby acknowledge receipt of the above described materials

JASON CARTER
Name (Print or Type)

[Signature]
Signature

10/6/10
Date Received

81 Environmental Tech
13550 N Highway 93
Las Vegas, NV 89165

Ticket Type: INBOUND INVOICE

Ticket Number: 1844
Date: 10/06/2010
Time In: 7:57 pm
Time Out: 8:21 pm

Customer: 001011 - NGE, LLC c/o Northgate Environ Mgmt

Vehicle/Container: 81494P
Contract: Northgate Env. On Site Soils 3825 11
Comment: 3825 10 11244

Gross Weight: 119,320 LB Manual In
Tare Weight: 53,340 LB Manual Out
Net Weight: 65980 LB
Net Tons: 32.99

BOL: 11935

Origin	Yards	Material	Billing	Quantity
Not Applicable	0.00 YD	SW CONTAMINATED SOIL	32.99	TN

Driver: _____



Weighmaster: _____



IN - SMITHJ OUT - CARTERJ

Indemnification. Customer agrees, by signature above, to indemnify, hold harmless, and defend Republic Services, Inc., its subsidiaries, affiliates, employees, officers and directors from and against any and all liabilities, claims, penalties, forfeitures, suits and the costs and expenses incident thereto, including costs of defense, settlement, and reasonable attorney's fees, which may be incurred, as a result of death or injuries to any person, or damage to any property, contamination of or adverse effects on the environment, caused in whole or in part by the Customer, its employees, or subcontractors in disposing waste at this Facility. In the event Customer delivers Unacceptable Waste (as determined by Republic) Customer agrees to assume all expenses and obligations with the removal and/or resolution of any effects caused by the delivery of such Unacceptable Waste.

Indemnización. Cliente acuerda indemnizar, mantener inmune, y defender Republic Services, Inc., sus subsidiarios, compañías, divisiones, empleados, oficiales y directores contra de cualquiera y de todas responsabilidades, demandas, penas, pérdidas, juicios, pleitos y los costos incidente además, incluyendo costos de defensa, de acuerdo judicial, y de honorarios razonables del abogado, que pueden ser incurridos en, o como resultado de, la muerte o herida personal a cualquier persona, o daños a cualquier característica, propiedad, contaminación de la tierra o efectos ilícitos en esta Facilidad, causado entero o en parte por el cliente, sus empleados, o sus subcontratistas en botar basura en esta Facilidad. En el caso que el Cliente entrega, bota, basura (según lo determinado por Republic) en este Establecimiento basura inaceptable en los reglamentos de este Establecimiento, el Cliente se compromete asumir todos los costos y obligaciones con el retiro y/o la resolución de cualquier dano(s) causado por la entrega de tal basura inaceptable.



NON-HAZARDOUS WASTE MANIFEST

MANIFEST # 11935

GENERATOR INFORMATION

Generator Name: Tronox LLC

Address: P.O. Box 55

City: Henderson County: Clark

State: NV Zip: 89009

Site Location (if different): 560 W. Lake Mead
Henderson, NV 89015 (702) 592-7727

CUSTOMER/BILLING INFORMATION

Billing Name: NGE LLC c/o Northgate Environment Management

Address: 300 Frank Ogawa Plaza, Ste 510

City: Oakland County: Alameda

State: CA Zip: 94612

Republic Services Approval #	Description of Waste	Volume/Weight	Expiration Date	Container Type
38251011244	Soil for disposal	32.99 TN	12-31-2011	Tractor with Dump Trailer(s)
	RZ- _____ # _____			

*Attach Additional Sheet if necessary

I hereby certify that the above-described materials are non-hazardous wastes as defined by 40 CFR 261 or any applicable state law. Further, that the above named materials are properly classified, described, packaged, marked and labeled, and are in proper condition for transportation according to the applicable regulations of the Department of Transportation.

Susan Crowley *Susan Crowley*
 Generator/Authorized Agent Name Signature Date Shipped

TRANSPORTER INFORMATION

Transporter Name: Las Vegas Paving

DOT # 191949

Address: 4420 S. Decatur

Truck Number: 125

Las Vegas, NV 89103

Phone Number: (702) 353-4355

I certify no hazardous waste or other regulated substance was knowingly introduced to the waste while in my custody. The waste transported in this vehicle is the waste identified above, to the best of my knowledge.

Calvin Pagan *Calvin Pagan* 10-06-10
 Name of Authorized Agent Signature Date Delivered

DISPOSAL SITE INFORMATION

Site Name: Apex Regional Landfill

Phone No. (702) 599-5920

Address: 13550 U.S. Hwy 93 Las Vegas, NV

I hereby acknowledge receipt of the above described materials

JASON CARLTON *JASON CARLTON* 10/6/10
 Name (Print or Type) Signature Date Received

81 Environmental Tech
13550 N Highway 93
Las Vegas, NV 89165

Ticket Type: INBOUND INVOICE

Ticket Number: 1845
Date: 10/06/2010
Time In: 7:59 pm
Time Out: 8:25 pm

Customer: 001011 - NGE, LLC c/o Northgate Environ Mgmt

Vehicle/Container: 34330A
Contract: Northgate Env. On Site Soils 3825 11
Comment: 3825 10 11244

Gross Weight: 121,580 LB Manual In
Tare Weight: 53,320 LB Manual Out
Net Weight: 68,260 LB
Net Tons: 34.13

BOL: 11936

Origin	Yards	Material	Billing	Quantity
Not Applicable	0.00 YD	SW CONTAMINATED SOIL	34.13	TN

Driver:

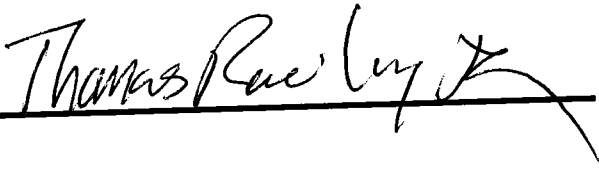

Weighmaster:

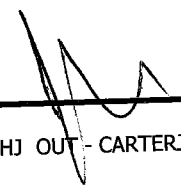
IN - SMITHJ OUT - CARTERJ

Indemnification. Customer agrees, by signature above, to indemnify, hold harmless, and defend Republic Services, Inc., its subsidiaries, affiliates, employees, officers and directors from and against any and all liabilities, claims, penalties, forfeitures, suits and the costs and expenses incident thereto, including costs of defense, settlement, and reasonable attorney's fees, which may be incurred, as a result of death or injuries to any person, or damage to any property, contamination of or adverse effects on the environment, caused in whole or in part by the Customer, its employees, or subcontractors in disposing waste at this Facility. In the event Customer delivers Unacceptable Waste (as determined by Republic) Customer agrees to assume all expenses and obligations with the removal and/or resolution of any effects caused by the delivery of such Unacceptable Waste.

Indemnización. Cliente acuerda indemnizar, mantener inmune, y defender Republic Services, Inc., sus subsidiarios, compañías, divisiones, empleados, oficiales y directores contra de cualquiera y de todas responsabilidades, demandas, penas, pérdidas, juicios, pleitos y los costos incidente además, incluyendo costos de defensa, de acuerdo judicial, y de honorarios razonables del abogado, que pueden ser incurridos en, o como resultado de, la muerte o herida personal a cualquier persona, o daños a cualquier característica, propiedad, contaminación de la tierra o efectos ilícitos en esta Facilidad, causado entero o en parte por el cliente, sus empleados, o sus subcontratistas en botar basura en esta Facilidad. En el caso que el Cliente entrega, bota, basura (según lo determinado por Republic) en este Establecimiento basura inaceptable en los reglamentos de este Establecimiento, el Cliente se compromete asumir todos los costos y obligaciones con el retiro y/o la resolución de cualquier dano(s) causado por la entrega de tal basura inaceptable.



NON-HAZARDOUS WASTE MANIFEST

MANIFEST # 11936

GENERATOR INFORMATION

Generator Name: Tronox LLC

Address: P.O. Box 55

City: Henderson County: Clark

State: NV Zip: 89009

Site Location (if different): 560 W. Lake Mead

Henderson, NV 89015 (702) 592-7727

CUSTOMER/BILLING INFORMATION

Billing Name: NGE LLC c/o Northgate Environment Management

Address: 300 Frank Ogawa Plaza, Ste 510

City: Oakland County: Alameda

State: CA Zip: 94612

Republic Services Approval #	Description of Waste	Volume/Weight	Expiration Date	Container Type
38251011244	Soil for disposal	34.13 TN	12-31-2011	Tractor with Dump Trailer(s)
	RZ- _____ # _____			

*Attach Additional Sheet if necessary

I hereby certify that the above-described materials are non-hazardous wastes as defined by 40 CFR 261 or any applicable state law. Further, that the above named materials are properly classified, described, packaged, marked and labeled, and are in proper condition for transportation according to the applicable regulations of the Department of Transportation.

Susan Crowley
Generator/Authorized Agent Name

Susan Crowley
Signature

Date Shipped

TRANSPORTER INFORMATION

Transporter Name: Las Vegas Paving

DOT # 191949

Address: 4420 S. Decatur

Truck Number: 981

Las Vegas, NV 89103

Phone Number: (702) 353-4355

I certify no hazardous waste or other regulated substance was knowingly introduced to the waste while in my custody. The waste transported in this vehicle is the waste identified above, to the best of my knowledge.

Tom Rawley
Name of Authorized Agent

Thomas Rawley
Signature

10-6-10
Date Delivered

DISPOSAL SITE INFORMATION

Site Name: Apex Regional Landfill

Phone No. (702) 599-5920

Address: 13550 U.S. Hwy 93 Las Vegas, NV

I hereby acknowledge receipt of the above described materials

JASON CACTIK
Name (Print or Type)

Jason Cactik
Signature

10/6/10
Date Received

81 Environmental Tech
13550 N Highway 93
Las Vegas, NV 89165

Ticket Type: INBOUND INVOICE

Ticket Number: 1846
Date: 10/06/2010
Time In: 8:07 pm
Time Out: 8:27 pm

Customer: 001011 - NGE, LLC c/o Northgate Environ Mgmt

Vehicle/Container: 82418P
Contract: Northgate Env. On Site Soils 3825 11
Comment: 3825 10 11244

Gross Weight: 129,180 LB Manual In
Tare Weight: 60,400 LB Manual Out
Net Weight: 68,780 LB
Net Tons: 34.39

BOL: 11938

Origin	Yards	Material	Billing	Quantity
Not Applicable	0.00 YD	SW CONTAMINATED SOIL	34.39	TN

Driver: _____

Weighmaster: _____

CARTERJ

Indemnification. Customer agrees, by signature above, to indemnify, hold harmless, and defend Republic Services, Inc., its subsidiaries, affiliates, employees, officers and directors from and against any and all liabilities, claims, penalties, forfeitures, suits and the costs and expenses incident thereto, including costs of defense, settlement, and reasonable attorney's fees, which may be incurred, as a result of death or injuries to any person, or damage to any property, contamination of or adverse effects on the environment, caused in whole or in part by the Customer, its employees, or subcontractors in disposing waste at this Facility. In the event Customer delivers Unacceptable Waste (as determined by Republic) Customer agrees to assume all expenses and obligations with the removal and/or resolution of any effects caused by the delivery of such Unacceptable Waste.

Indemnización. Cliente acuerda indemnizar, mantener inmune, y defender Republic Services, Inc., sus subsidiarios, compañías, divisiones, empleados, oficiales y directores contra de cualquiera y de todas responsabilidades, demandas, penas, pérdidas, juicios, pleitos y los costos incidente además, incluyendo costos de defensa, de acuerdo judicial, y de honorarios razonables del abogado, que pueden ser incurridos en, o como resultado de, la muerte o herida personal a cualquier persona, o daños a cualquier característica, propiedad, contaminación de la tierra o efectos ilícitos en esta Facilidad, causado entero o en parte por el cliente, sus empleados, o sus subcontratistas en botar basura en esta Facilidad. En el caso que el Cliente entrega, bota, basura (según lo determinado por Republic) en este Establecimiento basura inaceptable en los reglamentos de este Establecimiento, el Cliente se compromete asumir todos los costos y obligaciones con el retiro y/o la resolución de cualquier dano(s) causado por la entrega de tal basura inaceptable.



NON-HAZARDOUS WASTE MANIFEST

MANIFEST # 11938

GENERATOR INFORMATION

Generator Name: Tronox LLC

Address: P.O. Box 55

City: Henderson County: Clark

State: NV Zip: 89009

Site Location (if different): 560 W. Lake Mead

Henderson, NV 89015 (702) 592-7727

CUSTOMER/BILLING INFORMATION

Billing Name: NGE LLC c/o Northgate Environment Management

Address: 300 Frank Ogawa Plaza, Ste 510

City: Oakland County: Alameda

State: CA Zip: 94612

Republic Services Approval #	Description of Waste	Volume/Weight	Expiration Date	Container Type
38251011244	Soil for disposal	34.39 TN	12-31-2011	Tractor with Dump Trailer(s)
	RZ- #			

*Attach Additional Sheet if necessary

I hereby certify that the above-described materials are non-hazardous wastes as defined by 40 CFR 261 or any applicable state law. Further, that the above named materials are properly classified, described, packaged, marked and labeled, and are in proper condition for transportation according to the applicable regulations of the Department of Transportation.

Susan Crowley (Signature) Date Shipped

TRANSPORTER INFORMATION

Transporter Name: Las Vegas Paving

DOT # 191949

Address: 4420 S. Decatur

Truck Number: 220

Las Vegas, NV 89103

Phone Number: (702) 353-4355

I certify no hazardous waste or other regulated substance was knowingly introduced to the waste while in my custody. The waste transported in this vehicle is the waste identified above, to the best of my knowledge.

STEVE TAYLOR (Signature) 10-6-10 Date Delivered

DISPOSAL SITE INFORMATION

Site Name: Apex Regional Landfill

Phone No. (702) 599-5920

Address: 13550 U.S. Hwy 93 Las Vegas, NV

I hereby acknowledge receipt of the above described materials

JASON CARTER (Signature) 10/8/10 Date Received

81

Environmental Tech
13550 N Highway 93
Las Vegas, NV 89165

Ticket Type: INBOUND INVOICE

Ticket Number: 1847
Date: 10/06/2010
Time In: 8:10 pm
Time Out: 8:33 pm

Customer: 001011 - NGE, LLC c/o Northgate Environ Mgmt

Vehicle/Container: 86053P

Contract: Northgate Env. On Site Soils 3825 11
Comment: 3825 10 11244

Gross Weight: 124,580 LB Manual In
Tare Weight: 57,380 LB Manual Out
Net Weight: 67200 LB
Net Tons: 33.60

BOL: 11939

Origin	Yards	Material	Billing Quantity
Not Applicable	0.00 YD	SW CONTAMINATED SOIL	33.60 TN

Driver: _____

Weighmaster: _____

IN - SMITHJ OUT - CARTERJ

Indemnification. Customer agrees, by signature above, to indemnify, hold harmless, and defend Republic Services, Inc., its subsidiaries, affiliates, employees, officers and directors from and against any and all liabilities, claims, penalties, forfeitures, suits and the costs and expenses incident thereto, including costs of defense, settlement, and reasonable attorney's fees, which may be incurred, as a result of death or injuries to any person, or damage to any property, contamination of or adverse effects on the environment, caused in whole or in part by the Customer, its employees, or subcontractors in disposing waste at this Facility. In the event Customer delivers Unacceptable Waste (as determined by Republic) Customer agrees to assume all expenses and obligations with the removal and/or resolution of any effects caused by the delivery of such Unacceptable Waste.

Indemnización. Cliente acuerda indemnizar, mantener inmune, y defender Republic Services, Inc., sus subsidiarios compañías, divisiones, empleados, oficiales y directores contra de cualquiera y de todas responsabilidades, demandas penas, pérdidas, juicios, pleitos y los costos incidente además, incluyendo costos de defensa, de acuerdo judicial, y de honorarios razonables del abogado, que pueden ser incurridos en, o como resultado de, la muerte o herida persona a cualquier persona, o daños a cualquier característica, propiedad, contaminación de la tierra o efectos ilícitos en esta Facilidad, causado entero o en parte por el cliente, sus empleados, o sus subcontratistas en botar basura en est Facilidad. En el caso que el Cliente entrega, bota, basura (según lo determinado por Republic) en este Establecimiento basura inaceptable en los reglamentos de este Establecimiento, el Cliente se compromete asumir todos los costos obligaciones con el retiro y/o la resolución de cualquier dano(s) causado por la entrega de tal basura inaceptable.



NON-HAZARDOUS WASTE MANIFEST

MANIFEST # 11939

GENERATOR INFORMATION

Generator Name: Tronox LLC
Address: P.O. Box 55
City: Henderson County: Clark
State: NV Zip: 89009
Site Location (if different): 560 W. Lake Mead
Henderson, NV 89015 (702) 592-7727

CUSTOMER/BILLING INFORMATION

Billing Name: NGE LLC c/o Northgate Environment Management
Address: 300 Frank Ogawa Plaza, Ste 510
City: Oakland County: Alameda
State: CA Zip: 94612

Table with 5 columns: Republic Services Approval #, Description of Waste, Volume/Weight, Expiration Date, Container Type. Row 1: 38251011244, Soil for disposal, 33.60 TN, 12-31-2011, Tractor with Dump Trailer(s).

*Attach Additional Sheet if necessary

I hereby certify that the above-described materials are non-hazardous wastes as defined by 40 CFR 261 or any applicable state law. Further, that the above named materials are properly classified, described, packaged, marked and labeled, and are in proper condition for transportation according to the applicable regulations of the Department of Transportation.

Susan Crowley (Signature)
Generator/Authorized Agent Name Signature Date Shipped

TRANSPORTER INFORMATION

Transporter Name: Las Vegas Paving DOT # 191949
Address: 4420 S. Decatur Truck Number: 261
Las Vegas, NV 89103 Phone Number: (702) 353-4355

I certify no hazardous waste or other regulated substance was knowingly introduced to the waste while in my custody. The waste transported in this vehicle is the waste identified above, to the best of my knowledge.

(Signature) Patrick Woods (Signature) Date Delivered 6/6/10
Name of Authorized Agent Signature Date Delivered

DISPOSAL SITE INFORMATION

Site Name: Apex Regional Landfill Phone No. (702) 599-5920
Address: 13550 U.S. Hwy 93 Las Vegas, NV

I hereby acknowledge receipt of the above described materials
JASON CARTER (Signature) Date Received 10/6/10
Name (Print or Type) Signature Date Received

81

Environmental Tech
13550 N Highway 93
Las Vegas, NV 89165

Ticket Type: INBOUND INVOICE

Ticket Number: 1848
Date: 10/06/2010
Time In: 8:18 pm
Time Out: 8:39 pm

Customer: 001011 - NGE, LLC c/o Northgate Environ Mgmt

Vehicle/Container: 76810P

Contract: Northgate Env. On Site Soils 3825 11

Comment: 3825 10 11244

Gross Weight: 124,160 LB Manual In
Tare Weight: 55,640 LB Manual Out
Net Weight: 68520 LB
Net Tons: 34.26

BOL: 11941

Origin	Yards	Material	Billing Quantity
Not Applicable	0.00 YD	SW CONTAMINATED SOIL	34.26 TN

Driver:

Weighmaster:

IN - SMITHJ OUT - CARTERJ

Indemnification. Customer agrees, by signature above, to indemnify, hold harmless, and defend Republic Services, Inc., its subsidiaries, affiliates, employees, officers and directors from and against any and all liabilities, claims, penalties, forfeitures, suits and the costs and expenses incident thereto, including costs of defense, settlement, and reasonable attorney's fees, which may be incurred, as a result of death or injuries to any person, or damage to any property, contamination of or adverse effects on the environment, caused in whole or in part by the Customer, its employees, or subcontractors in disposing waste at this Facility. In the event Customer delivers Unacceptable Waste (as determined by Republic) Customer agrees to assume all expenses and obligations with the removal and/or resolution of any effects caused by the delivery of such Unacceptable Waste.

Indemnización. Cliente acuerda indemnizar, mantener inmune, y defender Republic Services, Inc., sus subsidiarios, compañías, divisiones, empleados, oficiales y directores contra de cualquiera y de todas responsabilidades, demandas, penas, pérdidas, juicios, pleitos y los costos incidente además, incluyendo costos de defensa, de acuerdo judicial, y de honorarios razonables del abogado, que pueden ser incurridos en, o como resultado de, la muerte o herida personal a cualquier persona, o daños a cualquier característica, propiedad, contaminación de la tierra o efectos ilícitos en esta Facilidad, causado entero o en parte por el cliente, sus empleados, o sus subcontratistas en botar basura en esta Facilidad. En el caso que el Cliente entrega, bota, basura (según lo determinado por Republic) en este Establecimiento basura inaceptable en los reglamentos de este Establecimiento, el Cliente se compromete asumir todos los costos y obligaciones con el retiro y/o la resolución de cualquier dano(s) causado por la entrega de tal basura inaceptable.



NON-HAZARDOUS WASTE MANIFEST

MANIFEST # 11941

GENERATOR INFORMATION

Generator Name: Tronox LLC

Address: P.O. Box 55

City: Henderson County: Clark

State: NV Zip: 89009

Site Location (if different): 560 W. Lake Mead

Henderson, NV 89015 (702) 592-7727

CUSTOMER/BILLING INFORMATION

Billing Name: NGE LLC c/o Northgate Environment Management

Address: 300 Frank Ogawa Plaza, Ste 510

City: Oakland County: Alameda

State: CA Zip: 94612

Republic Services Approval #	Description of Waste	Volume/Weight	Expiration Date	Container Type
38251011244	Soil for disposal	34.26 TN	12-31-2011	Tractor with Dump Trailer(s)
	RZ- _____ # _____			

*Attach Additional Sheet if necessary

I hereby certify that the above-described materials are non-hazardous wastes as defined by 40 CFR 261 or any applicable state law. Further, that the above named materials are properly classified, described, packaged, marked and labeled, and are in proper condition for transportation according to the applicable regulations of the Department of Transportation.

Susan Crowley [Signature] _____
 Generator/Authorized Agent Name Signature Date Shipped

TRANSPORTER INFORMATION

Transporter Name: Las Vegas Paving

DOT # 191949

Address: 4420 S. Decatur

Truck Number: 241

Las Vegas, NV 89103

Phone Number: (702) 353-4355

I certify no hazardous waste or other regulated substance was knowingly introduced to the waste while in my custody. The waste transported in this vehicle is the waste identified above, to the best of my knowledge.

Ken JACKSON [Signature] 10-6-2010
 Name of Authorized Agent Signature Date Delivered

DISPOSAL SITE INFORMATION

Site Name: Apex Regional Landfill

Phone No. (702) 599-5920

Address: 13550 U.S. Hwy 93 Las Vegas, NV

I hereby acknowledge receipt of the above described materials

JASON CARTER [Signature] 10/6/10
 Name (Print or Type) Signature Date Received

81 Environmental Tech
13550 N Highway 93
Las Vegas, NV 89165

Ticket Type: INBOUND INVOICE

Ticket Number: 1849
Date: 10/06/2010
Time In: 8:20 pm
Time Out: 8:44 pm

Customer: 001011 - NGE, LLC c/o Northgate Environ Mgmt

Vehicle/Container: 68263P
Contract: Northgate Env. On Site Soils 3825 11
Comment: 3825 10 11244

Gross Weight: 124,360 LB Manual In
Tare Weight: 53,520 LB Manual Out
Net Weight: 70840 LB
Net Tons: 35.42

BOL: 11940

Origin	Yards	Material	Billing	Quantity
Not Applicable	0.00 YD	SW CONTAMINATED SOIL	35.42	TN

Driver: _____

Weighmaster: _____

IN - SMITHJ OUT - CARTERJ

Indemnification. Customer agrees, by signature above, to indemnify, hold harmless, and defend Republic Services, Inc., its subsidiaries, affiliates, employees, officers and directors from and against any and all liabilities, claims, penalties, forfeitures, suits and the costs and expenses incident thereto, including costs of defense, settlement, and reasonable attorney's fees, which may be incurred, as a result of death or injuries to any person, or damage to any property, contamination of or adverse effects on the environment, caused in whole or in part by the Customer, its employees, or subcontractors in disposing waste at this Facility. In the event Customer delivers Unacceptable Waste (as determined by Republic) Customer agrees to assume all expenses and obligations with the removal and/or resolution of any effects caused by the delivery of such Unacceptable Waste.

Indemnización. Cliente acuerda indemnizar, mantener inmune, y defender Republic Services, Inc., sus subsidiarios, compañías, divisiones, empleados, oficiales y directores contra de cualquiera y de todas responsabilidades, demandas, penas, pérdidas, juicios, pleitos y los costos incidente además, incluyendo costos de defensa, de acuerdo judicial, y de honorarios razonables del abogado, que pueden ser incurridos en, o como resultado de, la muerte o herida personal a cualquier persona, o daños a cualquier característica, propiedad, contaminación de la tierra o efectos ilícitos en esta Facilidad, causado entero o en parte por el cliente, sus empleados, o sus subcontratistas en botar basura en esta Facilidad. En el caso que el Cliente entrega, bota, basura (según lo determinado por Republic) en este Establecimiento basura inaceptable en los reglamentos de este Establecimiento, el Cliente se compromete asumir todos los costos y obligaciones con el retiro y/o la resolución de cualquier dano(s) causado por la entrega de tal basura inaceptable.



NON-HAZARDOUS WASTE MANIFEST

MANIFEST # 11940

GENERATOR INFORMATION

Generator Name: Tronox LLCAddress: P.O. Box 55City: Henderson County: ClarkState: NV Zip: 89009Site Location (if different): 560 W. Lake MeadHenderson, NV 89015 (702) 592-7727

CUSTOMER/BILLING INFORMATION

Billing Name: NGE LLC c/o Northgate Environment ManagementAddress: 300 Frank Ogawa Plaza, Ste 510City: Oakland County: AlamedaState: CA Zip: 94612

Republic Services Approval #	Description of Waste	Volume/Weight	Expiration Date	Container Type
38251011244	Soil for disposal	35.42 TN	12-31-2011	Tractor with Dump Trailer(s)
	RZ- _____ # _____			

*Attach Additional Sheet if necessary

I hereby certify that the above-described materials are non-hazardous wastes as defined by 40 CFR 261 or any applicable state law. Further, that the above named materials are properly classified, described, packaged, marked and labeled, and are in proper condition for transportation according to the applicable regulations of the Department of Transportation.

Susan Crowley
Generator/Authorized Agent Name

Susan Crowley
Signature

Date Shipped

TRANSPORTER INFORMATION

Transporter Name: Las Vegas PavingDOT # 191949Address: 4420 S. DecaturTruck Number: ~~2711~~ 2711Las Vegas, NV 89103Phone Number: (702) 353-4355

I certify no hazardous waste or other regulated substance was knowingly introduced to the waste while in my custody. The waste transported in this vehicle is the waste identified above, to the best of my knowledge.

STEVEN HAYES
Name of Authorized Agent

Steven Hayes
Signature

10-6-10
Date Delivered

DISPOSAL SITE INFORMATION

Site Name: Apex Regional LandfillPhone No. (702) 599-5920Address: 13550 U.S. Hwy 93 Las Vegas, NV

I hereby acknowledge receipt of the above described materials

JASON CARTER
Name (Print or Type)

Jason Carter
Signature

10/6/10
Date Received

81 Environmental Tech
13550 N Highway 93
Las Vegas, NV 89165

Ticket Type: INBOUND INVOICE

Ticket Number: 1850
Date: 10/06/2010
Time In: 8:26 pm
Time Out: 8:51 pm

Customer: 001011 - NGE, LLC c/o Northgate Environ Mgmt

Vehicle/Container: 76811P
Contract: Northgate Env. On Site Soils 3825 11
Comment: 3825 10 11244

Gross Weight: 123,220 LB Manual In
Tare Weight: 50,700 LB Manual Out
Net Weight: 72520 LB
Net Tons: 36.26

BOL: 11942

Origin	Yards	Material	Billing	Quantity
Not Applicable	0.00 YD	SW CONTAMINATED SOIL	36.26	TN

Driver: 

Weighmaster: 

IN - CARTERJ OUT - SMITHJ

Indemnification. Customer agrees, by signature above, to indemnify, hold harmless, and defend Republic Services, Inc., its subsidiaries, affiliates, employees, officers and directors from and against any and all liabilities, claims, penalties, forfeitures, suits and the costs and expenses incident thereto, including costs of defense, settlement, and reasonable attorney's fees, which may be incurred, as a result of death or injuries to any person, or damage to any property, contamination of or adverse effects on the environment, caused in whole or in part by the Customer, its employees, or subcontractors in disposing waste at this Facility. In the event Customer delivers Unacceptable Waste (as determined by Republic) Customer agrees to assume all expenses and obligations with the removal and/or resolution of any effects caused by the delivery of such Unacceptable Waste.

Indemnización. Cliente acuerda indemnizar, mantener inmune, y defender Republic Services, Inc., sus subsidiarios, compañías, divisiones, empleados, oficiales y directores contra de cualquiera y de todas responsabilidades, demandas, penas, pérdidas, juicios, pleitos y los costos incidente además, incluyendo costos de defensa, de acuerdo judicial, y de honorarios razonables del abogado, que pueden ser incurridos en, o como resultado de, la muerte o herida personal a cualquier persona, o daños a cualquier característica, propiedad, contaminación de la tierra o efectos ilícitos en esta Facilidad, causado entero o en parte por el cliente, sus empleados, o sus subcontratistas en botar basura en esta Facilidad. En el caso que el Cliente entrega, bota, basura (según lo determinado por Republic) en este Establecimiento basura inaceptable en los reglamentos de este Establecimiento, el Cliente se compromete asumir todos los costos obligaciones con el retiro y/o la resolución de cualquier dano(s) causado por la entrega de tal basura inaceptable.



NON-HAZARDOUS WASTE MANIFEST

MANIFEST # 11942

GENERATOR INFORMATION

Generator Name: Tronox LLC

Address: P.O. Box 55

City: Henderson County: Clark

State: NV Zip: 89009

Site Location (if different): 560 W. Lake Mead

Henderson, NV 89015 (702) 592-7727

CUSTOMER/BILLING INFORMATION

Billing Name: NGE LLC c/o Northgate Environment Management

Address: 300 Frank Ogawa Plaza, Ste 510

City: Oakland County: Alameda

State: CA Zip: 94612

Republic Services Approval #	Description of Waste	Volume/Weight	Expiration Date	Container Type
38251011244	Soil for disposal		12-31-2011	Tractor with Dump Trailer(s)
	RZ-_____ # _____	36.26 TN		

*Attach Additional Sheet if necessary

I hereby certify that the above-described materials are non-hazardous wastes as defined by 40 CFR 261 or any applicable state law. Further, that the above named materials are properly classified, described, packaged, marked and labeled, and are in proper condition for transportation according to the applicable regulations of the Department of Transportation.

Susan Crowley Susan Crowley _____
 Generator/Authorized Agent Name Signature Date Shipped

TRANSPORTER INFORMATION

Transporter Name: Las Vegas Paving

DOT # 191949

Address: 4420 S. Decatur

Truck Number: 242

Las Vegas, NV 89103

Phone Number: (702) 353-4355

I certify no hazardous waste or other regulated substance was knowingly introduced to the waste while in my custody. The waste transported in this vehicle is the waste identified above, to the best of my knowledge.

Mike Hefferon Mike Hefferon _____
 Name of Authorized Agent Signature Date Delivered

DISPOSAL SITE INFORMATION

Site Name: Apex Regional Landfill

Phone No. (702) 599-5920

Address: 13550 U.S. Hwy 93 Las Vegas, NV

I hereby acknowledge receipt of the above described materials

JASON SM. TH _____
 Name (Print or Type) Signature Date Received

81 Environmental Tech
13550 N Highway 93
Las Vegas, NV 89165

Ticket Type: INBOUND INVOICE

Ticket Number: 1851
Date: 10/06/2010
Time In: 8:40 pm
Time Out: 9:10 pm

Customer: 001011 - NGE, LLC c/o Northgate Environ Mgmt

Vehicle/Container: 43073A
Contract: Northgate Env. On Site Soils 3825 11
Comment: 3825 10 11244

Gross Weight: 124,820 LB Manual In
Tare Weight: 55,180 LB Manual Out
Net Weight: 69640 LB
Net Tons: 34.82

BOL: 11943

Origin	Yards	Material	Billing Quantity
Not Applicable	0.00 YD	SW CONTAMINATED SOIL	34.82 TN

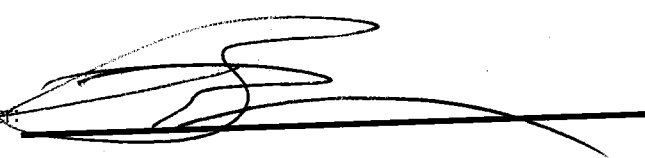
Driver: 

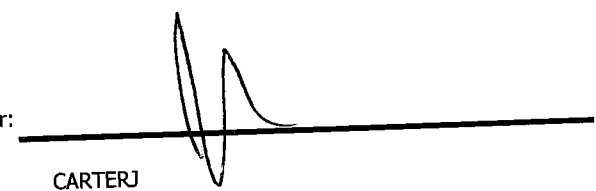
Weighmaster: 
CARTERJ

Indemnification. Customer agrees, by signature above, to indemnify, hold harmless, and defend Republic Services, Inc., its subsidiaries, affiliates, employees, officers and directors from and against any and all liabilities, claims, penalties, forfeitures, suits and the costs and expenses incident thereto, including costs of defense, settlement, and reasonable attorney's fees, which may be incurred, as a result of death or injuries to any person, or damage to any property, contamination of or adverse effects on the environment, caused in whole or in part by the Customer, its employees, or subcontractors in disposing waste at this Facility. In the event Customer delivers Unacceptable Waste (as determined by Republic) Customer agrees to assume all expenses and obligations with the removal and/or resolution of any effects caused by the delivery of such Unacceptable Waste.

Indemnización. Cliente acuerda indemnizar, mantener inmune, y defender Republic Services, Inc., sus subsidiarios, compañías, divisiones, empleados, oficiales y directores contra de cualquiera y de todas responsabilidades, demandas, penas, pérdidas, juicios, pleitos y los costos incidente además, incluyendo costos de defensa, de acuerdo judicial, y de honorarios razonables del abogado, que pueden ser incurridos en, o como resultado de, la muerte o herida personal a cualquier persona, o daños a cualquier característica, propiedad, contaminación de la tierra o efectos ilícitos en esta Facilidad, causado entero o en parte por el cliente, sus empleados, o sus subcontratistas en botar basura en esta Facilidad. En el caso que el Cliente entrega, bota, basura (según lo determinado por Republic) en este Establecimiento basura inaceptable en los reglamentos de este Establecimiento, el Cliente se compromete asumir todos los costos y obligaciones con el retiro y/o la resolución de cualquier dano(s) causado por la entrega de tal basura inaceptable.



NON-HAZARDOUS WASTE MANIFEST

MANIFEST # 11943

GENERATOR INFORMATION

Generator Name: Tronox LLC

Address: P.O. Box 55

City: Henderson County: Clark

State: NV Zip: 89009

Site Location (if different): 560 W. Lake Mead

Henderson, NV 89015 (702) 592-7727

CUSTOMER/BILLING INFORMATION

Billing Name: NGE LLC c/o Northgate Environment Management

Address: 300 Frank Ogawa Plaza, Ste 510

City: Oakland County: Alameda

State: CA Zip: 94612

Republic Services Approval #	Description of Waste	Volume/Weight	Expiration Date	Container Type
38251011244	Soil for disposal	34.82 TN	12-31-2011	Tractor with Dump Trailer(s)
	RZ- _____ # _____			

*Attach Additional Sheet if necessary

I hereby certify that the above-described materials are non-hazardous wastes as defined by 40 CFR 261 or any applicable state law. Further, that the above named materials are properly classified, described, packaged, marked and labeled, and are in proper condition for transportation according to the applicable regulations of the Department of Transportation.

Susan Crowley
Generator/Authorized Agent Name

Susan Crowley
Signature

Date Shipped

TRANSPORTER INFORMATION

Transporter Name: Las Vegas Paving

DOT # 191949

Address: 4420 S. Decatur

Truck Number: 89

Las Vegas, NV 89103

Phone Number: (702) 353-4355

I certify no hazardous waste or other regulated substance was knowingly introduced to the waste while in my custody. The waste transported in this vehicle is the waste identified above, to the best of my knowledge.

Beard Adams
Name of Authorized Agent

Beard Adams
Signature

10/6/10
Date Delivered

DISPOSAL SITE INFORMATION

Site Name: Apex Regional Landfill

Phone No. (702) 599-5920

Address: 13550 U.S. Hwy 93 Las Vegas, NV

I hereby acknowledge receipt of the above described materials

JASON CARTER
Name (Print or Type)

JASON CARTER
Signature

10/6/10
Date Received

81 Environmental Tech
13550 N Highway 93
Las Vegas, NV 89165

Ticket Type: INBOUND INVOICE

Ticket Number: 1852
Date: 10/06/2010
Time In: 9:00 pm
Time Out: 9:20 pm

Customer: 001011 - NGE, LLC c/o Northgate Environ Mgmt

Vehicle/Container: 44165A
Contract: Northgate Env. On Site Soils 3825 11
Comment: 3825 10 11244

Gross Weight: 127,340 LB Manual In
Tare Weight: 48,920 LB Manual Out
Net Weight: 78,420 LB
Net Tons: 39.21

BOL: 11944

Origin	Yards	Material	Billing	Quantity
Not Applicable	0.00 YD	SW CONTAMINATED SOIL	39.21	TN

Driver: _____

Weighmaster: _____

CARTERJ

Indemnification. Customer agrees, by signature above, to indemnify, hold harmless, and defend Republic Services, Inc., its subsidiaries, affiliates, employees, officers and directors from and against any and all liabilities, claims, penalties, forfeitures, suits and the costs and expenses incident thereto, including costs of defense, settlement, and reasonable attorney's fees, which may be incurred, as a result of death or injuries to any person, or damage to any property, contamination of or adverse effects on the environment, caused in whole or in part by the Customer, its employees, or subcontractors in disposing waste at this Facility. In the event Customer delivers Unacceptable Waste (as determined by Republic) Customer agrees to assume all expenses and obligations with the removal and/or resolution of any effects caused by the delivery of such Unacceptable Waste.

Indemnización. Cliente acuerda indemnizar, mantener inmune, y defender Republic Services, Inc., sus subsidiarios, compañías, divisiones, empleados, oficiales y directores contra de cualquiera y de todas responsabilidades, demandas, penas, pérdidas, juicios, pleitos y los costos incidente además, incluyendo costos de defensa, de acuerdo judicial, y de honorarios razonables del abogado, que pueden ser incurridos en, o como resultado de, la muerte o herida personal a cualquier persona, o daños a cualquier característica, propiedad, contaminación de la tierra o efectos ilícitos en esta Facilidad, causado entero o en parte por el cliente, sus empleados, o sus subcontratistas en botar basura en esta Facilidad. En el caso que el Cliente entrega, bota, basura (según lo determinado por Republic) en este Establecimiento basura inaceptable en los reglamentos de este Establecimiento, el Cliente se compromete asumir todos los costos y obligaciones con el retiro y/o la resolución de cualquier dano(s) causado por la entrega de tal basura inaceptable.



NON-HAZARDOUS WASTE MANIFEST

MANIFEST # 11944

GENERATOR INFORMATION

Generator Name: Tronox LLC
Address: P.O. Box 55
City: Henderson County: Clark
State: NV Zip: 89009
Site Location (if different): 560 W. Lake Mead
Henderson, NV 89015 (702) 592-7727

CUSTOMER/BILLING INFORMATION

Billing Name: NGE LLC c/o Northgate Environment Management
Address: 300 Frank Ogawa Plaza, Ste 510
City: Oakland County: Alameda
State: CA Zip: 94612

Table with 5 columns: Republic Services Approval #, Description of Waste, Volume/Weight, Expiration Date, Container Type. Row 1: 38251011244, Soil for disposal, 39.21 TN, 12-31-2011, Tractor with Dump Trailer(s).

*Attach Additional Sheet if necessary

I hereby certify that the above-described materials are non-hazardous wastes as defined by 40 CFR 261 or any applicable state law. Further, that the above named materials are properly classified, described, packaged, marked and labeled, and are in proper condition for transportation according to the applicable regulations of the Department of Transportation.

Susan Crowley
Generator/Authorized Agent Name Signature Date Shipped

TRANSPORTER INFORMATION

Transporter Name: Las Vegas Paving DOT # 191949
Address: 4420 S. Decatur Truck Number: K001
Las Vegas, NV 89103 Phone Number: (702) 353-4355

I certify no hazardous waste or other regulated substance was knowingly introduced to the waste while in my custody. The waste transported in this vehicle is the waste identified above, to the best of my knowledge.

CEBU
Name of Authorized Agent Signature Date Delivered 10/06/10

DISPOSAL SITE INFORMATION

Site Name: Apex Regional Landfill Phone No. (702) 599-5920
Address: 13550 U.S. Hwy 93 Las Vegas, NV

I hereby acknowledge receipt of the above described materials
Name (Print or Type) Signature Date Received 10/6/10

81 Environmental Tech
13550 N Highway 93
Las Vegas, NV 89165

Ticket Type: INBOUND INVOICE

Ticket Number: 1853
Date: 10/06/2010
Time In: 9:02 pm
Time Out: 9:27 pm

Customer: 001011 - NGE, LLC c/o Northgate Environ Mgmt

Vehicle/Container: 44564A
Contract: Northgate Env. On Site Soils 3825 11
Comment: 3825 10 11244

Gross Weight: 131,500 LB Manual In
Tare Weight: 49,760 LB Manual Out
Net Weight: 81740 LB
Net Tons: 40.87

BOL: 11945

Origin	Yards	Material	Billing Quantity
Not Applicable	0.00 YD	SW CONTAMINATED SOIL	40.87 TN

Driver: _____

Weighmaster: _____

IN - CARTERJ OUT - SMITHJ

Indemnification. Customer agrees, by signature above, to indemnify, hold harmless, and defend Republic Services, Inc., its subsidiaries, affiliates, employees, officers and directors from and against any and all liabilities, claims, penalties, forfeitures, suits and the costs and expenses incident thereto, including costs of defense, settlement, and reasonable attorney's fees, which may be incurred, as a result of death or injuries to any person, or damage to any property, contamination of or adverse effects on the environment, caused in whole or in part by the Customer, its employees, or subcontractors in disposing waste at this Facility. In the event Customer delivers Unacceptable Waste (as determined by Republic) Customer agrees to assume all expenses and obligations with the removal and/or resolution of any effects caused by the delivery of such Unacceptable Waste.

Indemnización. Cliente acuerda indemnizar, mantener inmune, y defender Republic Services, Inc., sus subsidiarios, compañías, divisiones, empleados, oficiales y directores contra de cualquiera y de todas responsabilidades, demandas, penas, pérdidas, juicios, pleitos y los costos incidente además, incluyendo costos de defensa, de acuerdo judicial, y de honorarios razonables del abogado, que pueden ser incurridos en, o como resultado de, la muerte o herida personal a cualquier persona, o daños a cualquier característica, propiedad, contaminación de la tierra o efectos ilícitos en esta Facilidad, causado entero o en parte por el cliente, sus empleados, o sus subcontratistas en botar basura en esta Facilidad. En el caso que el Cliente entrega, bota, basura (según lo determinado por Republic) en este Establecimiento basura inaceptable en los reglamentos de este Establecimiento, el Cliente se compromete asumir todos los costos y obligaciones con el retiro y/o la resolución de cualquier dano(s) causado por la entrega de tal basura inaceptable.



NON-HAZARDOUS WASTE MANIFEST

MANIFEST # 11945

GENERATOR INFORMATION

Generator Name: Tronox LLC

Address: P.O. Box 55

City: Henderson County: Clark

State: NV Zip: 89009

Site Location (if different): 560 W. Lake Mead

Henderson, NV 89015 (702) 592-7727

CUSTOMER/BILLING INFORMATION

Billing Name: NGE LLC c/o Northgate Environment Management

Address: 300 Frank Ogawa Plaza, Ste 510

City: Oakland County: Alameda

State: CA Zip: 94612

Republic Services Approval #	Description of Waste	Volume/Weight	Expiration Date	Container Type
38251011244	Soil for disposal		12-31-2011	Tractor with Dump Trailer(s)
	RZ- _____ # _____	40.87 Tn		

*Attach Additional Sheet if necessary

I hereby certify that the above-described materials are non-hazardous wastes as defined by 40 CFR 261 or any applicable state law. Further, that the above named materials are properly classified, described, packaged, marked and labeled, and are in proper condition for transportation according to the applicable regulations of the Department of Transportation.

Susan Crowley (Signature) Date Shipped

TRANSPORTER INFORMATION

Transporter Name: Las Vegas Paving

DOT # 191949

Address: 4420 S. Decatur

Truck Number: K003

Las Vegas, NV 89103

Phone Number: (702) 353-4355

I certify no hazardous waste or other regulated substance was knowingly introduced to the waste while in my custody. The waste transported in this vehicle is the waste identified above, to the best of my knowledge.

Asencion (Signature) Date Delivered 10/08/10

DISPOSAL SITE INFORMATION

Site Name: Apex Regional Landfill

Phone No. (702) 599-5920

Address: 13550 U.S. Hwy 93 Las Vegas, NV

I hereby acknowledge receipt of the above described materials

Jason Smith (Signature) Date Received 10-6-10

81 Environmental Tech
13550 N Highway 93
Las Vegas, NV 89165

Ticket Type: INBOUND INVOICE

Ticket Number: 1854
Date: 10/06/2010
Time In: 9:31 pm
Time Out: 10:04 pm

Customer: 001011 - NGE, LLC c/o Northgate Environ Mgmt

Vehicle/Container: 86113P
Contract: Northgate Env. On Site Soils 3825 11
Comment: 3825 10 11244

Gross Weight: 135,460 LB Manual In
Tare Weight: 55,700 LB Manual Out
Net Weight: 79,760 LB
Net Tons: 39.88

BOL: 11946

Origin	Yards	Material	Billing Quantity
Not Applicable	0.00 YD	SW CONTAMINATED SOIL	39.88 TN

Driver: _____

J. A. H.

Weighmaster: _____

CARTERJ

Indemnification. Customer agrees, by signature above, to indemnify, hold harmless, and defend Republic Services, Inc., its subsidiaries, affiliates, employees, officers and directors from and against any and all liabilities, claims, penalties, forfeitures, suits and the costs and expenses incident thereto, including costs of defense, settlement, and reasonable attorney's fees, which may be incurred, as a result of death or injuries to any person, or damage to any property, contamination of or adverse effects on the environment, caused in whole or in part by the Customer, its employees, or subcontractors in disposing waste at this Facility. In the event Customer delivers Unacceptable Waste (as determined by Republic) Customer agrees to assume all expenses and obligations with the removal and/or resolution of any effects caused by the delivery of such Unacceptable Waste.

Indemnización. Cliente acuerda indemnizar, mantener inmune, y defender Republic Services, Inc., sus subsidiarios, compañías, divisiones, empleados, oficiales y directores contra de cualquiera y de todas responsabilidades, demandas, penas, pérdidas, juicios, pleitos y los costos incidente además, incluyendo costos de defensa, de acuerdo judicial, y de honorarios razonables del abogado, que pueden ser incurridos en, o como resultado de, la muerte o herida personal a cualquier persona, o daños a cualquier característica, propiedad, contaminación de la tierra o efectos ilícitos en esta Facilidad, causado entero o en parte por el cliente, sus empleados, o sus subcontratistas en botar basura en esta Facilidad. En el caso que el Cliente entrega, bota, basura (según lo determinado por Republic) en este Establecimiento basura inaceptable en los reglamentos de este Establecimiento, el Cliente se compromete asumir todos los costos y obligaciones con el retiro y/o la resolución de cualquier dano(s) causado por la entrega de tal basura inaceptable.



NON-HAZARDOUS WASTE MANIFEST

MANIFEST # 11946

GENERATOR INFORMATION

Generator Name: Tronox LLCAddress: P.O. Box 55City: Henderson County: ClarkState: NV Zip: 89009Site Location (if different): 560 W. Lake MeadHenderson, NV 89015 (702) 592-7727

CUSTOMER/BILLING INFORMATION

Billing Name: NGE LLC c/o Northgate Environment ManagementAddress: 300 Frank Ogawa Plaza, Ste 510City: Oakland County: AlamedaState: CA Zip: 94612

Republic Services Approval #	Description of Waste	Volume/Weight	Expiration Date	Container Type
38251011244	Soil for disposal	39.88 TN	12-31-2011	Tractor with Dump Trailer(s)
	RZ- _____ # _____			

*Attach Additional Sheet if necessary

I hereby certify that the above-described materials are non-hazardous wastes as defined by 40 CFR 261 or any applicable state law. Further, that the above named materials are properly classified, described, packaged, marked and labeled, and are in proper condition for transportation according to the applicable regulations of the Department of Transportation.

Susan Crowley
 Generator/Authorized Agent Name

Susan Crowley
 Signature

Date Shipped

TRANSPORTER INFORMATION

Transporter Name: Las Vegas PavingDOT # 191949Address: 4420 S. DecaturTruck Number: K0014 / 7Las Vegas, NV 89103Phone Number: (702) 353-4355

I certify no hazardous waste or other regulated substance was knowingly introduced to the waste while in my custody. The waste transported in this vehicle is the waste identified above, to the best of my knowledge.

ALBERTO
 Name of Authorized Agent

Alberto
 Signature

Date Delivered

Oct 6, 2010

DISPOSAL SITE INFORMATION

Site Name: Apex Regional LandfillPhone No. (702) 599-5920Address: 13550 U.S. Hwy 93 Las Vegas, NV

I hereby acknowledge receipt of the above described materials

JASON CARPIS
 Name (Print or Type)

Jason Carpis
 Signature

Date Received

10/6/10

81 Environmental Tech
13550 N Highway 93
Las Vegas, NV 89165

Ticket Type: INBOUND INVOICE

Ticket Number: 1855
Date: 10/06/2010
Time In: 9:32 pm
Time Out: 10:06 pm

Customer: 001011 - NGE, LLC c/o Northgate Environ Mgmt

Vehicle/Container: 85887P
Contract: Northgate Env. On Site Soils 3825 11
Comment: 3825 10 11244

Gross Weight: 135,460 LB Manual In
Tare Weight: 51,920 LB Manual Out
Net Weight: 83540 LB
Net Tons: 41.77

BOL: 11947

Origin	Yards	Material	Billing Quantity
Not Applicable	0.00 YD	SW CONTAMINATED SOIL	41.77 TN

Driver:

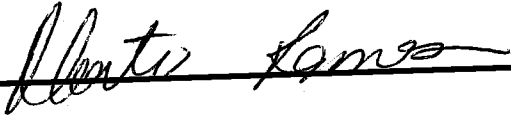

Weighmaster:

IN - SMITHJ OUT - CARTERJ

Indemnification. Customer agrees, by signature above, to indemnify, hold harmless, and defend Republic Services, Inc., its subsidiaries, affiliates, employees, officers and directors from and against any and all liabilities, claims, penalties, forfeitures, suits and the costs and expenses incident thereto, including costs of defense, settlement, and reasonable attorney's fees, which may be incurred, as a result of death or injuries to any person, or damage to any property, contamination of or adverse effects on the environment, caused in whole or in part by the Customer, its employees, or subcontractors in disposing waste at this Facility. In the event Customer delivers Unacceptable Waste (as determined by Republic) Customer agrees to assume all expenses and obligations with the removal and/or resolution of any effects caused by the delivery of such Unacceptable Waste.

Indemnización. Cliente acuerda indemnizar, mantener inmune, y defender Republic Services, Inc., sus subsidiarios, compañías, divisiones, empleados, oficiales y directores contra de cualquiera y de todas responsabilidades, demandas, penas, pérdidas, juicios, pleitos y los costos incidente además, incluyendo costos de defensa, de acuerdo judicial, y de honorarios razonables del abogado, que pueden ser incurridos en, o como resultado de, la muerte o herida personal a cualquier persona, o daños a cualquier característica, propiedad, contaminación de la tierra o efectos ilícitos en esta Facilidad, causado entero o en parte por el cliente, sus empleados, o sus subcontratistas en botar basura en esta Facilidad. En el caso que el Cliente entrega, bota, basura (según lo determinado por Republic) en este Establecimiento basura inaceptable en los reglamentos de este Establecimiento, el Cliente se compromete asumir todos los costos y obligaciones con el retiro y/o la resolución de cualquier dano(s) causado por la entrega de tal basura inaceptable.



NON-HAZARDOUS WASTE MANIFEST

MANIFEST # 11947

GENERATOR INFORMATION

Generator Name: Tronox LLC
Address: P.O. Box 55
City: Henderson County: Clark
State: NV Zip: 89009
Site Location (if different): 560 W. Lake Mead
Henderson, NV 89015 (702) 592-7727

CUSTOMER/BILLING INFORMATION

Billing Name: NGE LLC c/o Northgate Environment Management
Address: 300 Frank Ogawa Plaza, Ste 510
City: Oakland County: Alameda
State: CA Zip: 94612

Table with 5 columns: Republic Services Approval #, Description of Waste, Volume/Weight, Expiration Date, Container Type. Row 1: 38251011244, Soil for disposal, 41.77 TN, 12-31-2011, Tractor with Dump Trailer(s).

*Attach Additional Sheet if necessary

I hereby certify that the above-described materials are non-hazardous wastes as defined by 40 CFR 261 or any applicable state law. Further, that the above named materials are properly classified, described, packaged, marked and labeled, and are in proper condition for transportation according to the applicable regulations of the Department of Transportation.

Susan Crowley (Signature)
Generator/Authorized Agent Name Signature Date Shipped

TRANSPORTER INFORMATION

Transporter Name: Las Vegas Paving DOT # 191949
Address: 4420 S. Decatur Truck Number: R01
Las Vegas, NV 89103 Phone Number: (702) 353-4355

I certify no hazardous waste or other regulated substance was knowingly introduced to the waste while in my custody. The waste transported in this vehicle is the waste identified above, to the best of my knowledge.

Name of Authorized Agent (Signature) Signature Date Delivered (Signature) 10/6/10

DISPOSAL SITE INFORMATION

Site Name: Apex Regional Landfill Phone No. (702) 599-5920
Address: 13550 U.S. Hwy 93 Las Vegas, NV

I hereby acknowledge receipt of the above described materials
Name (Print or Type) TASON CARTER Signature Date Received 10/6/10

81 Environmental Tech
13550 N Highway 93
Las Vegas, NV 89165

Ticket Type: INBOUND INVOICE

Ticket Number: 1856
Date: 10/06/2010
Time In: 9:38 pm
Time Out: 10:07 pm

Customer: 001011 - NGE, LLC c/o Northgate Environ Mgmt

Vehicle/Container: 44166A
Contract: Northgate Env. On Site Soils 3825 11
Comment: 3825 10 11244

Gross Weight: 136,980 LB Manual In
Tare Weight: 57,480 LB Manual Out
Net Weight: 79,500 LB
Net Tons: 39.75

BOL: 11948

Origin	Yards	Material	Billing Quantity
Not Applicable	0.00 YD	SW CONTAMINATED SOIL	39.75 TN

Driver: _____

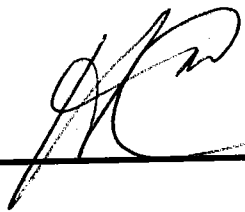

Weighmaster: _____

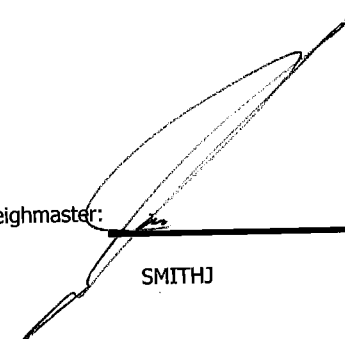

SMITHJ

Indemnification. Customer agrees, by signature above, to indemnify, hold harmless, and defend Republic Services, Inc., its subsidiaries, affiliates, employees, officers and directors from and against any and all liabilities, claims, penalties, forfeitures, suits and the costs and expenses incident thereto, including costs of defense, settlement, and reasonable attorney's fees, which may be incurred, as a result of death or injuries to any person, or damage to any property, contamination of or adverse effects on the environment, caused in whole or in part by the Customer, its employees, or subcontractors in disposing waste at this Facility. In the event Customer delivers Unacceptable Waste (as determined by Republic) Customer agrees to assume all expenses and obligations with the removal and/or resolution of any effects caused by the delivery of such Unacceptable Waste.

Indemnización. Cliente acuerda indemnizar, mantener inmune, y defender Republic Services, Inc., sus subsidiarios, compañías, divisiones, empleados, oficiales y directores contra de cualquiera y de todas responsabilidades, demandas, penas, pérdidas, juicios, pleitos y los costos incidente además, incluyendo costos de defensa, de acuerdo judicial, y de honorarios razonables del abogado, que pueden ser incurridos en, o como resultado de, la muerte o herida personal a cualquier persona, o daños a cualquier característica, propiedad, contaminación de la tierra o efectos ilícitos en esta Facilidad, causado entero o en parte por el cliente, sus empleados, o sus subcontratistas en botar basura en esta Facilidad. En el caso que el Cliente entrega, bota, basura (según lo determinado por Republic) en este Establecimiento basura inaceptable en los reglamentos de este Establecimiento, el Cliente se compromete asumir todos los costos y obligaciones con el retiro y/o la resolución de cualquier dano(s) causado por la entrega de tal basura inaceptable.



NON-HAZARDOUS WASTE MANIFEST

MANIFEST # 11948

GENERATOR INFORMATION

Generator Name: Tronox LLC

Address: P.O. Box 55

City: Henderson County: Clark

State: NV Zip: 89009

Site Location (if different): 560 W. Lake Mead

Henderson, NV 89015 (702) 592-7727

CUSTOMER/BILLING INFORMATION

Billing Name: NGE LLC c/o Northgate Environment Management

Address: 300 Frank Ogawa Plaza, Ste 510

City: Oakland County: Alameda

State: CA Zip: 94612

Republic Services Approval #	Description of Waste	Volume/Weight	Expiration Date	Container Type
38251011244	Soil for disposal		12-31-2011	Tractor with Dump Trailer(s)
	RZ- _____ # _____	39.75 TON		

*Attach Additional Sheet if necessary

I hereby certify that the above-described materials are non-hazardous wastes as defined by 40 CFR 261 or any applicable state law. Further, that the above named materials are properly classified, described, packaged, marked and labeled, and are in proper condition for transportation according to the applicable regulations of the Department of Transportation.

Susan Crowley (Signature)
Generator/Authorized Agent Name Signature Date Shipped

TRANSPORTER INFORMATION

Transporter Name: Las Vegas Paving

DOT # 191949

Address: 4420 S. Decatur

Truck Number: K002

Las Vegas, NV 89103

Phone Number: (702) 353-4355

I certify no hazardous waste or other regulated substance was knowingly introduced to the waste while in my custody. The waste transported in this vehicle is the waste identified above, to the best of my knowledge.

Miguel Castell (Signature)
Name of Authorized Agent Signature Date Delivered 10-6-10

DISPOSAL SITE INFORMATION

Site Name: Apex Regional Landfill

Phone No. (702) 599-5920

Address: 13550 U.S. Hwy 93 Las Vegas, NV

I hereby acknowledge receipt of the above described materials

Jesse Smith (Signature)
Name (Print or Type) Signature Date Received 10-6-10

81 Environmental Tech
13550 N Highway 93
Las Vegas, NV 89165

Ticket Type: INBOUND INVOICE

Ticket Number: 1857
Date: 10/06/2010
Time In: 9:39 pm
Time Out: 10:10 pm

Customer: 001011 - NGE, LLC c/o Northgate Environ Mgmt

Vehicle/Container: 192457
Contract: Northgate Env. On Site Soils 3825 11
Comment: 3825 10 11244

Gross Weight: 123,440 LB Manual In
Tare Weight: 55,460 LB Manual Out
Net Weight: 67980 LB
Net Tons: 33.99

BOL: 11949

Origin	Yards	Material	Billing	Quantity
Not Applicable	0.00 YD	SW CONTAMINATED SOIL	33.99	TN

Driver: 

Weighmaster: 

SMITHJ

Indemnification. Customer agrees, by signature above, to indemnify, hold harmless, and defend Republic Services, Inc., its subsidiaries, affiliates, employees, officers and directors from and against any and all liabilities, claims, penalties, forfeitures, suits and the costs and expenses incident thereto, including costs of defense, settlement, and reasonable attorney's fees, which may be incurred, as a result of death or injuries to any person, or damage to any property, contamination of or adverse effects on the environment, caused in whole or in part by the Customer, its employees, or subcontractors in disposing waste at this Facility. In the event Customer delivers Unacceptable Waste (as determined by Republic) Customer agrees to assume all expenses and obligations with the removal and/or resolution of any effects caused by the delivery of such Unacceptable Waste.

Indemnización. Cliente acuerda indemnizar, mantener inmune, y defender Republic Services, Inc., sus subsidiarios, compañías, divisiones, empleados, oficiales y directores contra de cualquiera y de todas responsabilidades, demandas, penas, pérdidas, juicios, pleitos y los costos incidente además, incluyendo costos de defensa, de acuerdo judicial, y de honorarios razonables del abogado, que pueden ser incurridos en, o como resultado de, la muerte o herida personal a cualquier persona, o daños a cualquier característica, propiedad, contaminación de la tierra o efectos ilícitos en esta Facilidad, causado entero o en parte por el cliente, sus empleados, o sus subcontratistas en botar basura en esta Facilidad. En el caso que el Cliente entrega, bota, basura (según lo determinado por Republic) en este Establecimiento basura inaceptable en los reglamentos de este Establecimiento, el Cliente se compromete asumir todos los costos y obligaciones con el retiro y/o la resolución de cualquier dano(s) causado por la entrega de tal basura inaceptable.



NON-HAZARDOUS WASTE MANIFEST

MANIFEST # 11949

GENERATOR INFORMATION

Generator Name: Tronox LLC

Address: P.O. Box 55

City: Henderson County: Clark

State: NV Zip: 89009

Site Location (if different): 560 W. Lake Mead

Henderson, NV 89015 (702) 592-7727

CUSTOMER/BILLING INFORMATION

Billing Name: NGE LLC c/o Northgate Environment Management

Address: 300 Frank Ogawa Plaza, Ste 510

City: Oakland County: Alameda

State: CA Zip: 94612

Republic Services Approval #	Description of Waste	Volume/Weight	Expiration Date	Container Type
38251011244	Soil for disposal		12-31-2011	Tractor with Dump Trailer(s)
	RZ-_____ # _____	33.99 TN		

*Attach Additional Sheet if necessary

I hereby certify that the above-described materials are non-hazardous wastes as defined by 40 CFR 261 or any applicable state law. Further, that the above named materials are properly classified, described, packaged, marked and labeled, and are in proper condition for transportation according to the applicable regulations of the Department of Transportation.

Susan Crowley Tom Lowley
 Generator/Authorized Agent Name Signature Date Shipped

TRANSPORTER INFORMATION

Transporter Name: Las Vegas Paving

DOT # 191949

Address: 4420 S. Decatur

Truck Number: 198457

Las Vegas, NV 89103

Phone Number: (702) 353-4355

I certify no hazardous waste or other regulated substance was knowingly introduced to the waste while in my custody. The waste transported in this vehicle is the waste identified above, to the best of my knowledge.

Brian Zinderhoff [Signature] 10-6-10
 Name of Authorized Agent Signature Date Delivered

DISPOSAL SITE INFORMATION

Site Name: Apex Regional Landfill

Phone No. (702) 599-5920

Address: 13550 U.S. Hwy 93 Las Vegas, NV

I hereby acknowledge receipt of the above described materials
Jessie Smith [Signature] 10-6-10
 Name (Print or Type) Signature Date Received

81 Environmental Tech
13550 N Highway 93
Las Vegas, NV 89165

Ticket Type: INBOUND INVOICE

Ticket Number: 1858
Date: 10/06/2010
Time In: 9:43 pm
Time Out: 10:12 pm

Customer: 001011 - NGE, LLC c/o Northgate Environ Mgmt

Vehicle/Container: 192460
Contract: Northgate Env. On Site Soils 3825 11
Comment: 3825 10 11244

Gross Weight: 127,540 LB Manual In
Tare Weight: 54,140 LB Manual Out
Net Weight: 73400 LB
Net Tons: 36.70

BOL: 11950

Origin	Yards	Material	Billing	Quantity
Not Applicable	0.00 YD	SW CONTAMINATED SOIL	36.70	TN

Driver:



Weighmaster:

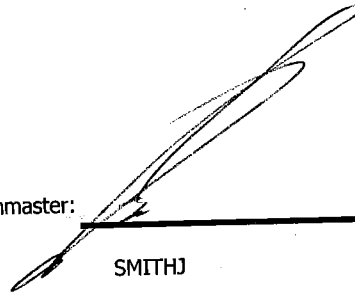

SMITHJ

Indemnification. Customer agrees, by signature above, to indemnify, hold harmless, and defend Republic Services, Inc., its subsidiaries, affiliates, employees, officers and directors from and against any and all liabilities, claims, penalties, forfeitures, suits and the costs and expenses incident thereto, including costs of defense, settlement, and reasonable attorney's fees, which may be incurred, as a result of death or injuries to any person, or damage to any property, contamination of or adverse effects on the environment, caused in whole or in part by the Customer, its employees, or subcontractors in disposing waste at this Facility. In the event Customer delivers Unacceptable Waste (as determined by Republic) Customer agrees to assume all expenses and obligations with the removal and/or resolution of any effects caused by the delivery of such Unacceptable Waste.

Indemnización. Cliente acuerda indemnizar, mantener inmune, y defender Republic Services, Inc., sus subsidiarios, compañías, divisiones, empleados, oficiales y directores contra de cualquiera y de todas responsabilidades, demandas, penas, pérdidas, juicios, pleitos y los costos incidente además, incluyendo costos de defensa, de acuerdo judicial, y de honorarios razonables del abogado, que pueden ser incurridos en, o como resultado de, la muerte o herida personal a cualquier persona, o daños a cualquier característica, propiedad, contaminación de la tierra o efectos ilícitos en esta Facilidad, causado entero o en parte por el cliente, sus empleados, o sus subcontratistas en botar basura en esta Facilidad. En el caso que el Cliente entrega, bota, basura (según lo determinado por Republic) en este Establecimiento basura inaceptable en los reglamentos de este Establecimiento, el Cliente se compromete asumir todos los costos y obligaciones con el retiro y/o la resolución de cualquier dano(s) causado por la entrega de tal basura inaceptable.



NON-HAZARDOUS WASTE MANIFEST

MANIFEST # 11950

GENERATOR INFORMATION

Generator Name: Tronox LLC
 Address: P.O. Box 55
 City: Henderson County: Clark
 State: NV Zip: 89009
 Site Location (if different): 560 W. Lake Mead
Henderson, NV 89015 (702) 592-7727

CUSTOMER/BILLING INFORMATION

Billing Name: NGE LLC c/o Northgate Environment Management
 Address: 300 Frank Ogawa Plaza, Ste 510
 City: Oakland County: Alameda
 State: CA Zip: 94612

Republic Services Approval #	Description of Waste	Volume/Weight	Expiration Date	Container Type
38251011244	Soil for disposal		12-31-2011	Tractor with Dump Trailer(s)
	RZ- #	36.70 FN		

*Attach Additional Sheet if necessary

I hereby certify that the above-described materials are non-hazardous wastes as defined by 40 CFR 261 or any applicable state law. Further, that the above named materials are properly classified, described, packaged, marked and labeled, and are in proper condition for transportation according to the applicable regulations of the Department of Transportation.

Susan Crowley [Signature] _____
 Generator/Authorized Agent Name Signature Date Shipped

TRANSPORTER INFORMATION

Transporter Name: Las Vegas Paving DOT # 191949
 Address: 4420 S. Decatur Truck Number: 2460
Las Vegas, NV 89103 Phone Number: (702) 353-4355

I certify no hazardous waste or other regulated substance was knowingly introduced to the waste while in my custody. The waste transported in this vehicle is the waste identified above, to the best of my knowledge.

Graig Honish [Signature] 10-6-10
 Name of Authorized Agent Signature Date Delivered

DISPOSAL SITE INFORMATION

Site Name: Apex Regional Landfill Phone No. (702) 599-5920
 Address: 13550 U.S. Hwy 93 Las Vegas, NV

I hereby acknowledge receipt of the above described materials
[Signature] _____
 Name (Print or Type) Signature Date Received

81 Environmental Tech
13550 N Highway 93
Las Vegas, NV 89165

Ticket Type: INBOUND INVOICE

Ticket Number: 1859
Date: 10/06/2010
Time In: 9:56 pm
Time Out: 10:18 pm

Customer: 001011 - NGE, LLC c/o Northgate Environ Mgmt

Vehicle/Container: 84598P
Contract: Northgate Env. On Site Soils 3825 11
Comment: 3825 10 11244

Gross Weight: 123,340 LB Manual In
Tare Weight: 53,360 LB Manual Out
Net Weight: 69980 LB
Net Tons: 34.99

BOL: 11952

Origin	Yards	Material	Billing Quantity
Not Applicable	0.00 YD	SW CONTAMINATED SOIL	34.99 TN

Driver: _____

Weighmaster: _____

SMITHJ

Indemnification. Customer agrees, by signature above, to indemnify, hold harmless, and defend Republic Services, Inc., its subsidiaries, affiliates, employees, officers and directors from and against any and all liabilities, claims, penalties, forfeitures, suits and the costs and expenses incident thereto, including costs of defense, settlement, and reasonable attorney's fees, which may be incurred, as a result of death or injuries to any person, or damage to any property, contamination of or adverse effects on the environment, caused in whole or in part by the Customer, its employees, or subcontractors in disposing waste at this Facility. In the event Customer delivers Unacceptable Waste (as determined by Republic) Customer agrees to assume all expenses and obligations with the removal and/or resolution of any effects caused by the delivery of such Unacceptable Waste.

Indemnización. Cliente acuerda indemnizar, mantener inmune, y defender Republic Services, Inc., sus subsidiarios, compañías, divisiones, empleados, oficiales y directores contra de cualquiera y de todas responsabilidades, demandas, penas, pérdidas, juicios, pleitos y los costos incidente además, incluyendo costos de defensa, de acuerdo judicial, y de honorarios razonables del abogado, que pueden ser incurridos en, o como resultado de, la muerte o herida personal a cualquier persona, o daños a cualquier característica, propiedad, contaminación de la tierra o efectos ilícitos en esta Facilidad, causado entero o en parte por el cliente, sus empleados, o sus subcontratistas en botar basura en esta Facilidad. En el caso que el Cliente entrega, bota, basura (según lo determinado por Republic) en este Establecimiento basura inaceptable en los reglamentos de este Establecimiento, el Cliente se compromete asumir todos los costos y obligaciones con el retiro y/o la resolución de cualquier dano(s) causado por la entrega de tal basura inaceptable.



NON-HAZARDOUS WASTE MANIFEST

MANIFEST # 11952

GENERATOR INFORMATION

Generator Name: Tronox LLC
Address: P.O. Box 55
City: Henderson County: Clark
State: NV Zip: 89009
Site Location (if different): 560 W. Lake Mead
Henderson, NV 89015 (702) 592-7727

CUSTOMER/BILLING INFORMATION

Billing Name: NGE LLC c/o Northgate Environment Management
Address: 300 Frank Ogawa Plaza, Ste 510
City: Oakland County: Alameda
State: CA Zip: 94612

Table with 5 columns: Republic Services Approval #, Description of Waste, Volume/Weight, Expiration Date, Container Type. Row 1: 38251011244, Soil for disposal, 89.99 TN, 12-31-2011, Tractor with Dump Trailer(s).

*Attach Additional Sheet if necessary

I hereby certify that the above-described materials are non-hazardous wastes as defined by 40 CFR 261 or any applicable state law. Further, that the above named materials are properly classified, described, packaged, marked and labeled, and are in proper condition for transportation according to the applicable regulations of the Department of Transportation.

Susan Crowley
Generator/Authorized Agent Name Signature Date Shipped

TRANSPORTER INFORMATION

Transporter Name: Las Vegas Paving DOT # 191949
Address: 4420 S. Decatur Truck Number: 28
Las Vegas, NV 89103 Phone Number: (702) 353-4355

I certify no hazardous waste or other regulated substance was knowingly introduced to the waste while in my custody. The waste transported in this vehicle is the waste identified above, to the best of my knowledge.

Name of Authorized Agent Signature Date Delivered 10-6-10

DISPOSAL SITE INFORMATION

Site Name: Apex Regional Landfill Phone No. (702) 599-5920
Address: 13550 U.S. Hwy 93 Las Vegas, NV

I hereby acknowledge receipt of the above described materials
Name (Print or Type) Signature Date Received 10-6-10

81 Environmental Tech
13550 N Highway 93
Las Vegas, NV 89165

Ticket Type: INBOUND INVOICE

Ticket Number: 1860
Date: 10/06/2010
Time In: 9:45 pm
Time Out: 10:25 pm

Customer: 001011 - NGE, LLC c/o Northgate Environ Mgmt

Vehicle/Container: 192456
Contract: Northgate Env. On Site Soils 3825 11
Comment: 3825 10 11244

Gross Weight: 127,180 LB Manual In
Tare Weight: 53,060 LB Manual Out
Net Weight: 74120 LB
Net Tons: 37.06

BOL: 11951

Origin	Yards	Material	Billing	Quantity
Not Applicable	0.00 YD	SW CONTAMINATED SOIL	37.06	TN

Driver: _____

Weighmaster: _____

SMITHJ

Indemnification. Customer agrees, by signature above, to indemnify, hold harmless, and defend Republic Services, Inc., its subsidiaries, affiliates, employees, officers and directors from and against any and all liabilities, claims, penalties, forfeitures, suits and the costs and expenses incident thereto, including costs of defense, settlement, and reasonable attorney's fees, which may be incurred, as a result of death or injuries to any person, or damage to any property, contamination of or adverse effects on the environment, caused in whole or in part by the Customer, its employees, or subcontractors in disposing waste at this Facility. In the event Customer delivers Unacceptable Waste (as determined by Republic) Customer agrees to assume all expenses and obligations with the removal and/or resolution of any effects caused by the delivery of such Unacceptable Waste.

Indemnización. Cliente acuerda indemnizar, mantener inmune, y defender Republic Services, Inc., sus subsidiarios, compañías, divisiones, empleados, oficiales y directores contra de cualquiera y de todas responsabilidades, demandas, penas, pérdidas, juicios, pleitos y los costos incidente además, incluyendo costos de defensa, de acuerdo judicial, y de honorarios razonables del abogado, que pueden ser incurridos en, o como resultado de, la muerte o herida personal a cualquier persona, o daños a cualquier característica, propiedad, contaminación de la tierra o efectos ilícitos en esta Facilidad, causado entero o en parte por el cliente, sus empleados, o sus subcontratistas en botar basura en esta Facilidad. En el caso que el Cliente entrega, bota, basura (según lo determinado por Republic) en este Establecimiento basura inaceptable en los reglamentos de este Establecimiento, el Cliente se compromete asumir todos los costos y obligaciones con el retiro y/o la resolución de cualquier dano(s) causado por la entrega de tal basura inaceptable.



NON-HAZARDOUS WASTE MANIFEST

MANIFEST # 11951

GENERATOR INFORMATION

Generator Name: Tronox LLC

Address: P.O. Box 55

City: Henderson County: Clark

State: NV Zip: 89009

Site Location (if different): 560 W. Lake Mead

Henderson, NV 89015 (702) 592-7727

CUSTOMER/BILLING INFORMATION

Billing Name: NGE LLC c/o Northgate Environment Management

Address: 300 Frank Ogawa Plaza, Ste 510

City: Oakland County: Alameda

State: CA Zip: 94612

Republic Services Approval #	Description of Waste	Volume/Weight	Expiration Date	Container Type
38251011244	Soil for disposal		12-31-2011	Tractor with Dump Trailer(s)
	RZ-_____ # _____	37.06 TN		

*Attach Additional Sheet if necessary

I hereby certify that the above-described materials are non-hazardous wastes as defined by 40 CFR 261 or any applicable state law. Further, that the above named materials are properly classified, described, packaged, marked and labeled, and are in proper condition for transportation according to the applicable regulations of the Department of Transportation.

Susan Crowley
Generator/Authorized Agent Name

Susan Crowley
Signature

Date Shipped

TRANSPORTER INFORMATION

Transporter Name: Las Vegas Paving

DOT # 191949

Address: 4420 S. Decatur

Truck Number: 192456

Las Vegas, NV 89103

Phone Number: (702) 353-4355

I certify no hazardous waste or other regulated substance was knowingly introduced to the waste while in my custody. The waste transported in this vehicle is the waste identified above, to the best of my knowledge.

Bla...
Name of Authorized Agent

[Signature]
Signature

10/6/10
Date Delivered

DISPOSAL SITE INFORMATION

Site Name: Apex Regional Landfill

Phone No. (702) 599-5920

Address: 13550 U.S. Hwy 93 Las Vegas, NV

I hereby acknowledge receipt of the above described materials

[Signature]
Name (Print or Type)

[Signature]
Signature

6-6-10
Date Received

81 Environmental Tech
13550 N Highway 93
Las Vegas, NV 89165

Ticket Type: INBOUND INVOICE

Ticket Number: 1861
Date: 10/06/2010
Time In: 10:06 pm
Time Out: 10:28 pm

Customer: 001011 - NGE, LLC c/o Northgate Environ Mgmt

Vehicle/Container: 81496P
Contract: Northgate Env. On Site Soils 3825 11
Comment: 3825 10 11244

Gross Weight: 116,300 LB Manual In
Tare Weight: 50,660 LB Manual Out
Net Weight: 65640 LB
Net Tons: 32.82

BOL: 11953

Origin	Yards	Material	Billing Quantity
Not Applicable	0.00 YD	SW CONTAMINATED SOIL	32.82 TN

Driver: _____



Weighmaster: _____

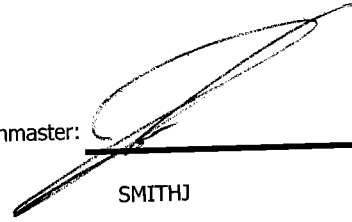

SMITHJ

Indemnification. Customer agrees, by signature above, to indemnify, hold harmless, and defend Republic Services, Inc., its subsidiaries, affiliates, employees, officers and directors from and against any and all liabilities, claims, penalties, forfeitures, suits and the costs and expenses incident thereto, including costs of defense, settlement, and reasonable attorney's fees, which may be incurred, as a result of death or injuries to any person, or damage to any property, contamination of or adverse effects on the environment, caused in whole or in part by the Customer, its employees, or subcontractors in disposing waste at this Facility. In the event Customer delivers Unacceptable Waste (as determined by Republic) Customer agrees to assume all expenses and obligations with the removal and/or resolution of any effects caused by the delivery of such Unacceptable Waste.

Indemnización. Cliente acuerda indemnizar, mantener inmune, y defender Republic Services, Inc., sus subsidiarios, compañías, divisiones, empleados, oficiales y directores contra de cualquiera y de todas responsabilidades, demandas, penas, pérdidas, juicios, pleitos y los costos incidente además, incluyendo costos de defensa, de acuerdo judicial, y de honorarios razonables del abogado, que pueden ser incurridos en, o como resultado de, la muerte o herida personal a cualquier persona, o daños a cualquier característica, propiedad, contaminación de la tierra o efectos ilícitos en esta Facilidad, causado entero o en parte por el cliente, sus empleados, o sus subcontratistas en botar basura en esta Facilidad. En el caso que el Cliente entrega, bota, basura (según lo determinado por Republic) en este Establecimiento basura inaceptable en los reglamentos de este Establecimiento, el Cliente se compromete asumir todos los costos y obligaciones con el retiro y/o la resolución de cualquier dano(s) causado por la entrega de tal basura inaceptable.



NON-HAZARDOUS WASTE MANIFEST

MANIFEST # 11953

GENERATOR INFORMATION

Generator Name: Tronox LLC

Address: P.O. Box 55

City: Henderson County: Clark

State: NV Zip: 89009

Site Location (if different): 560 W. Lake Mead

Henderson, NV 89015 (702) 592-7727

CUSTOMER/BILLING INFORMATION

Billing Name: NGE LLC c/o Northgate Environment Management

Address: 300 Frank Ogawa Plaza, Ste 510

City: Oakland County: Alameda

State: CA Zip: 94612

Republic Services Approval #	Description of Waste	Volume/Weight	Expiration Date	Container Type
38251011244	Soil for disposal		12-31-2011	Tractor with Dump Trailer(s)
	RZ- #	32.8270		

*Attach Additional Sheet if necessary

I hereby certify that the above-described materials are non-hazardous wastes as defined by 40 CFR 261 or any applicable state law. Further, that the above named materials are properly classified, described, packaged, marked and labeled, and are in proper condition for transportation according to the applicable regulations of the Department of Transportation.

Susan Crowley

Susan Crowley

Generator/Authorized Agent Name

Signature

Date Shipped

TRANSPORTER INFORMATION

Transporter Name: Las Vegas Paving

DOT # 191949

Address: 4420 S. Decatur

Truck Number: 145

Las Vegas, NV 89103

Phone Number: (702) 353-4355

I certify no hazardous waste or other regulated substance was knowingly introduced to the waste while in my custody. The waste transported in this vehicle is the waste identified above, to the best of my knowledge.

Harry McBride

Harry McBride

10-6-10

Name of Authorized Agent

Signature

Date Delivered

DISPOSAL SITE INFORMATION

Site Name: Apex Regional Landfill

Phone No. (702) 599-5920

Address: 13550 U.S. Hwy 93 Las Vegas, NV

I hereby acknowledge receipt of the above described materials

Jesse Smith

Jesse Smith

10-6-10

Name (Print or Type)

Signature

Date Received

81 Environmental Tech
13550 N Highway 93
Las Vegas, NV 89165

Ticket Type: INBOUND INVOICE

Ticket Number: 1862
Date: 10/06/2010
Time In: 10:11 pm
Time Out: 10:39 pm

Customer: 001011 - NGE, LLC c/o Northgate Environ Mgmt

Vehicle/Container: 81495P

Contract: Northgate Env. On Site Soils 3825 11
Comment: 3825 10 11244

Gross Weight: 122,700 LB Manual In
Tare Weight: 53,340 LB Manual Out
Net Weight: 69360 LB
Net Tons: 34.68

BOL: 11954

Origin	Yards	Material	Billing	Quantity
Not Applicable	0.00 YD	SW CONTAMINATED SOIL	34.68	TN

Driver: 

Weighmaster: 

SMITHJ

Indemnification: Customer agrees, by signature above, to indemnify, hold harmless, and defend Republic Services, Inc., its subsidiaries, affiliates, employees, officers and directors from and against any and all liabilities, claims, penalties, forfeitures, suits and the costs and expenses incident thereto, including costs of defense, settlement, and reasonable attorney's fees, which may be incurred, as a result of death or injuries to any person, or damage to any property, contamination of or adverse effects on the environment, caused in whole or in part by the Customer, its employees, or subcontractors in disposing waste at this Facility. In the event Customer delivers Unacceptable Waste (as determined by Republic) Customer agrees to assume all expenses and obligations with the removal and/or resolution of any effects caused by the delivery of such Unacceptable Waste.

Indemnización. Cliente acuerda indemnizar, mantener inmune, y defender Republic Services, Inc., sus subsidiarios, compañías, divisiones, empleados, oficiales y directores contra de cualquiera y de todas responsabilidades, demandas, penas, pérdidas, juicios, pleitos y los costos incidente además, incluyendo costos de defensa, de acuerdo judicial, y de honorarios razonables del abogado, que pueden ser incurridos en, o como resultado de, la muerte o herida personal a cualquier persona, o daños a cualquier característica, propiedad, contaminación de la tierra o efectos ilícitos en esta Facilidad, causado entero o en parte por el cliente, sus empleados, o sus subcontratistas en botar basura en esta Facilidad. En el caso que el Cliente entrega, bota, basura (según lo determinado por Republic) en este Establecimiento basura inaceptable en los reglamentos de este Establecimiento, el Cliente se compromete asumir todos los costos y obligaciones con el retiro y/o la resolución de cualquier dano(s) causado por la entrega de tal basura inaceptable.



SK 40236

NON-HAZARDOUS WASTE MANIFEST

MANIFEST # 11954

GENERATOR INFORMATION

Generator Name: Tronox LLC

Address: P.O. Box 55

City: Henderson County: Clark

State: NV Zip: 89009

Site Location (if different): 560 W. Lake Mead

Henderson, NV 89015 (702) 592-7727

CUSTOMER/BILLING INFORMATION

Billing Name: NGE LLC c/o Northgate Environment Management

Address: 300 Frank Ogawa Plaza, Ste 510

City: Oakland County: Alameda

State: CA Zip: 94612

Republic Services Approval #	Description of Waste	Volume/Weight	Expiration Date	Container Type
38251011244	Soil for disposal		12-31-2011	Tractor with Dump Trailer(s)
	RZ- _____ # _____	34.68 TON		

*Attach Additional Sheet if necessary

I hereby certify that the above-described materials are non-hazardous wastes as defined by 40 CFR 261 or any applicable state law. Further, that the above named materials are properly classified, described, packaged, marked and labeled, and are in proper condition for transportation according to the applicable regulations of the Department of Transportation.

Susan Crowley [Signature] _____
 Generator/Authorized Agent Name Signature Date Shipped

TRANSPORTER INFORMATION

Transporter Name: Las Vegas Paving

DOT # 191949

Address: 4420 S. Decatur

Truck Number: 175

Las Vegas, NV 89103

Phone Number: (702) 353-4355

I certify no hazardous waste or other regulated substance was knowingly introduced to the waste while in my custody. The waste transported in this vehicle is the waste identified above, to the best of my knowledge.

Larry Harnsberger [Signature] _____
 Name of Authorized Agent Signature Date Delivered 10-6-10

DISPOSAL SITE INFORMATION

Site Name: Apex Regional Landfill

Phone No. (702) 599-5920

Address: 13550 U.S. Hwy 93 Las Vegas, NV

I hereby acknowledge receipt of the above described materials

[Signature] _____
 Name (Print or Type) Signature Date Received 10-6-10

81 Environmental Tech
13550 N Highway 93
Las Vegas, NV 89165

Ticket Type: INBOUND INVOICE

Ticket Number: 1863
Date: 10/06/2010
Time In: 10:16 pm
Time Out: 10:41 pm

Customer: 001011 - NGE, LLC c/o Northgate Environ Mgmt

Vehicle/Container: 81494P
Contract: Northgate Env. On Site Soils 3825 11
Comment: 3825 10 11244

Gross Weight: 122,340 LB Manual In
Tare Weight: 51,580 LB Manual Out
Net Weight: 70760 LB
Net Tons: 35.38

BOL: 11955

Origin	Yards	Material	Billing	Quantity
Not Applicable	0.00 YD	SW CONTAMINATED SOIL	35.38	TN

Driver: _____



Weighmaster: _____

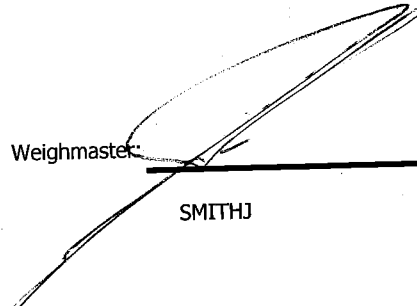

SMITHJ

Indemnification. Customer agrees, by signature above, to indemnify, hold harmless, and defend Republic Services, Inc., its subsidiaries, affiliates, employees, officers and directors from and against any and all liabilities, claims, penalties, forfeitures, suits and the costs and expenses incident thereto, including costs of defense, settlement, and reasonable attorney's fees, which may be incurred, as a result of death or injuries to any person, or damage to any property, contamination of or adverse effects on the environment, caused in whole or in part by the Customer, its employees, or subcontractors in disposing waste at this Facility. In the event Customer delivers Unacceptable Waste (as determined by Republic) Customer agrees to assume all expenses and obligations with the removal and/or resolution of any effects caused by the delivery of such Unacceptable Waste.

Indemnización. Cliente acuerda indemnizar, mantener inmune, y defender Republic Services, Inc., sus subsidiarios, compañías, divisiones, empleados, oficiales y directores contra de cualquiera y de todas responsabilidades, demandas, penas, pérdidas, juicios, pleitos y los costos incidente además, incluyendo costos de defensa, de acuerdo judicial, y de honorarios razonables del abogado, que pueden ser incurridos en, o como resultado de, la muerte o herida personal a cualquier persona, o daños a cualquier característica, propiedad, contaminación de la tierra o efectos ilícitos en esta Facilidad, causado entero o en parte por el cliente, sus empleados, o sus subcontratistas en botar basura en esta Facilidad. En el caso que el Cliente entrega, bota, basura (según lo determinado por Republic) en este Establecimiento basura inaceptable en los reglamentos de este Establecimiento, el Cliente se compromete asumir todos los costos y obligaciones con el retiro y/o la resolución de cualquier dano(s) causado por la entrega de tal basura inaceptable.



NON-HAZARDOUS WASTE MANIFEST

MANIFEST # 11955

GENERATOR INFORMATION

Generator Name: Tronox LLC
Address: P.O. Box 55
City: Henderson County: Clark
State: NV Zip: 89009
Site Location (if different): 560 W. Lake Mead
Henderson, NV 89015 (702) 592-7727

CUSTOMER/BILLING INFORMATION

Billing Name: NGE LLC c/o Northgate Environment Management
Address: 300 Frank Ogawa Plaza, Ste 510
City: Oakland County: Alameda
State: CA Zip: 94612

Table with 5 columns: Republic Services Approval #, Description of Waste, Volume/Weight, Expiration Date, Container Type. Row 1: 38251011244, Soil for disposal, 25.38 TU, 12-31-2011, Tractor with Dump Trailer(s).

*Attach Additional Sheet if necessary

I hereby certify that the above-described materials are non-hazardous wastes as defined by 40 CFR 261 or any applicable state law. Further, that the above named materials are properly classified, described, packaged, marked and labeled, and are in proper condition for transportation according to the applicable regulations of the Department of Transportation.

Susan Crowley (Signature)
Generator/Authorized Agent Name Signature Date Shipped

TRANSPORTER INFORMATION

Transporter Name: Las Vegas Paving DOT # 191949
Address: 4420 S. Decatur Truck Number: 125
Las Vegas, NV 89103 Phone Number: (702) 353-4355

I certify no hazardous waste or other regulated substance was knowingly introduced to the waste while in my custody. The waste transported in this vehicle is the waste identified above, to the best of my knowledge.

Calvin Paguyo (Signature)
Name of Authorized Agent Signature Date Delivered 10-05-10

DISPOSAL SITE INFORMATION

Site Name: Apex Regional Landfill Phone No. (702) 599-5920
Address: 13550 U.S. Hwy 93 Las Vegas, NV

I hereby acknowledge receipt of the above described materials
Name (Print or Type) Signature Date Received 10-6-10

81 Environmental Tech
13550 N Highway 93
Las Vegas, NV 89165

Ticket Type: INBOUND INVOICE

Ticket Number: 1864
Date: 10/06/2010
Time In: 10:26 pm
Time Out: 10:48 pm

Customer: 001011 - NGE, LLC c/o Northgate Environ Mgmt

Vehicle/Container: 82418P
Contract: Northgate Env. On Site Soils 3825 11
Comment: 3825 10 11244

Gross Weight: 128,900 LB Manual In
Tare Weight: 64,100 LB Manual Out
Net Weight: 64800 LB
Net Tons: 32.40

BOL: 11957

Origin	Yards	Material	Billing	Quantity
Not Applicable	0.00 YD	SW CONTAMINATED SOIL	32.40	TN

Driver: 

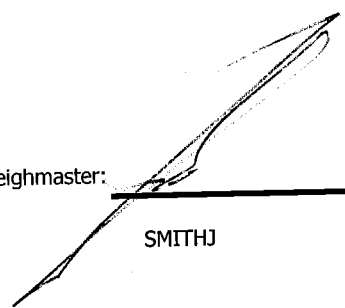
Weighmaster: 
SMITHJ

Indemnification. Customer agrees, by signature above, to indemnify, hold harmless, and defend Republic Services, Inc., its subsidiaries, affiliates, employees, officers and directors from and against any and all liabilities, claims, penalties, forfeitures, suits and the costs and expenses incident thereto, including costs of defense, settlement, and reasonable attorney's fees, which may be incurred, as a result of death or injuries to any person, or damage to any property, contamination of or adverse effects on the environment, caused in whole or in part by the Customer, its employees, or subcontractors in disposing waste at this Facility. In the event Customer delivers Unacceptable Waste (as determined by Republic) Customer agrees to assume all expenses and obligations with the removal and/or resolution of any effects caused by the delivery of such Unacceptable Waste.

Indemnización. Cliente acuerda indemnizar, mantener inmune, y defender Republic Services, Inc., sus subsidiarios, compañías, divisiones, empleados, oficiales y directores contra de cualquiera y de todas responsabilidades, demandas, penas, pérdidas, juicios, pleitos y los costos incidente además, incluyendo costos de defensa, de acuerdo judicial, y de honorarios razonables del abogado, que pueden ser incurridos en, o como resultado de, la muerte o herida personal a cualquier persona, o daños a cualquier característica, propiedad, contaminación de la tierra o efectos ilícitos en esta Facilidad, causado entero o en parte por el cliente, sus empleados, o sus subcontratistas en botar basura en esta Facilidad. En el caso que el Cliente entrega, bota, basura (según lo determinado por Republic) en este Establecimiento basura inaceptable en los reglamentos de este Establecimiento, el Cliente se compromete asumir todos los costos y obligaciones con el retiro y/o la resolución de cualquier dano(s) causado por la entrega de tal basura inaceptable.



NON-HAZARDOUS WASTE MANIFEST

MANIFEST # 11957

GENERATOR INFORMATION

Generator Name: Tronox LLC

Address: P.O. Box 55

City: Henderson County: Clark

State: NV Zip: 89009

Site Location (if different): 560 W. Lake Mead

Henderson, NV 89015 (702) 592-7727

CUSTOMER/BILLING INFORMATION

Billing Name: NGE LLC c/o Northgate Environment Management

Address: 300 Frank Ogawa Plaza, Ste 510

City: Oakland County: Alameda

State: CA Zip: 94612

Republic Services Approval #	Description of Waste	Volume/Weight	Expiration Date	Container Type
38251011244	Soil for disposal		12-31-2011	Tractor with Dump Trailer(s)
	RZ- #	32.4670		

*Attach Additional Sheet if necessary

I hereby certify that the above-described materials are non-hazardous wastes as defined by 40 CFR 261 or any applicable state law. Further, that the above named materials are properly classified, described, packaged, marked and labeled, and are in proper condition for transportation according to the applicable regulations of the Department of Transportation.

Susan Crowley Generator/Authorized Agent Name Signature Date Shipped

TRANSPORTER INFORMATION

Transporter Name: Las Vegas Paving

DOT #: 191949

Address: 4420 S. Decatur

Truck Number: 220

Las Vegas, NV 89103

Phone Number: (702) 353-4355

I certify no hazardous waste or other regulated substance was knowingly introduced to the waste while in my custody. The waste transported in this vehicle is the waste identified above, to the best of my knowledge.

STEVE TAYLOR Name of Authorized Agent Signature Date Delivered 10-6-10

DISPOSAL SITE INFORMATION

Site Name: Apex Regional Landfill

Phone No. (702) 599-5920

Address: 13550 U.S. Hwy 93 Las Vegas, NV

I hereby acknowledge receipt of the above described materials Name (Print or Type) Signature Date Received 10-6-10

81 Environmental Tech
13550 N Highway 93
Las Vegas, NV 89165

Ticket Type: INBOUND INVOICE

Ticket Number: 1865
Date: 10/06/2010
Time In: 10:22 pm
Time Out: 10:48 pm

Customer: 001011 - NGE, LLC c/o Northgate Environ Mgmt

Vehicle/Container: 34330A
Contract: Northgate Env. On Site Soils 3825 11
Comment: 3825 10 11244

Gross Weight: 117,560 LB Manual In
Tare Weight: 53,800 LB Manual Out
Net Weight: 63760 LB
Net Tons: 31.88

BOL: 11956

Origin	Yards	Material	Billing	Quantity
Not Applicable	0.00 YD	SW CONTAMINATED SOIL	31.88	TN

Driver:

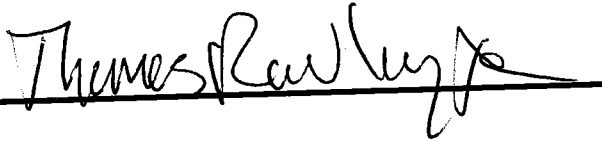

Weighmaster:

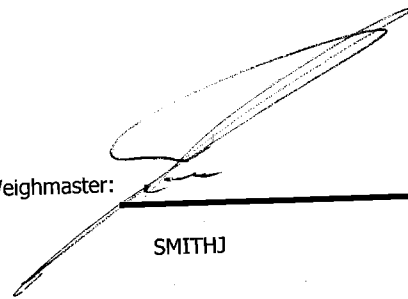

SMITHJ

Indemnification. Customer agrees, by signature above, to indemnify, hold harmless, and defend Republic Services, Inc., its subsidiaries, affiliates, employees, officers and directors from and against any and all liabilities, claims, penalties, forfeitures, suits and the costs and expenses incident thereto, including costs of defense, settlement, and reasonable attorney's fees, which may be incurred, as a result of death or injuries to any person, or damage to any property, contamination of or adverse effects on the environment, caused in whole or in part by the Customer, its employees, or subcontractors in disposing waste at this Facility. In the event Customer delivers Unacceptable Waste (as determined by Republic) Customer agrees to assume all expenses and obligations with the removal and/or resolution of any effects caused by the delivery of such Unacceptable Waste.

Indemnización. Cliente acuerda indemnizar, mantener inmune, y defender Republic Services, Inc., sus subsidiarios, compañías, divisiones, empleados, oficiales y directores contra de cualquiera y de todas responsabilidades, demandas, penas, pérdidas, juicios, pleitos y los costos incidente además, incluyendo costos de defensa, de acuerdo judicial, y de honorarios razonables del abogado, que pueden ser incurridos en, o como resultado de, la muerte o herida personal a cualquier persona, o daños a cualquier característica, propiedad, contaminación de la tierra o efectos ilícitos en esta Facilidad, causado entero o en parte por el cliente, sus empleados, o sus subcontratistas en botar basura en esta Facilidad. En el caso que el Cliente entrega, bota, basura (según lo determinado por Republic) en este Establecimiento basura inaceptable en los reglamentos de este Establecimiento, el Cliente se compromete asumir todos los costos y obligaciones con el retiro y/o la resolución de cualquier dano(s) causado por la entrega de tal basura inaceptable.



NON-HAZARDOUS WASTE MANIFEST

MANIFEST # 11956

GENERATOR INFORMATION

Generator Name: Tronox LLC

Address: P.O. Box 55

City: Henderson County: Clark

State: NV Zip: 89009

Site Location (if different): 560 W. Lake Mead

Henderson, NV 89015 (702) 592-7727

CUSTOMER/BILLING INFORMATION

Billing Name: NGE LLC c/o Northgate Environment Management

Address: 300 Frank Ogawa Plaza, Ste 510

City: Oakland County: Alameda

State: CA Zip: 94612

Republic Services Approval #	Description of Waste	Volume/Weight	Expiration Date	Container Type
38251011244	Soil for disposal		12-31-2011	Tractor with Dump Trailer(s)
	RZ- #	31.88 TN		

*Attach Additional Sheet if necessary

I hereby certify that the above-described materials are non-hazardous wastes as defined by 40 CFR 261 or any applicable state law. Further, that the above named materials are properly classified, described, packaged, marked and labeled, and are in proper condition for transportation according to the applicable regulations of the Department of Transportation.

Susan Crowley Generator/Authorized Agent Name Signature Date Shipped

TRANSPORTER INFORMATION

Transporter Name: Las Vegas Paving

DOT # 191949

Address: 4420 S. Decatur

Truck Number: 981

Las Vegas, NV 89103

Phone Number: (702) 353-4355

I certify no hazardous waste or other regulated substance was knowingly introduced to the waste while in my custody. The waste transported in this vehicle is the waste identified above, to the best of my knowledge.

Tom Rawlins Name of Authorized Agent Signature Date Delivered 10-6-10

DISPOSAL SITE INFORMATION

Site Name: Apex Regional Landfill

Phone No. (702) 599-5920

Address: 13550 U.S. Hwy 93 Las Vegas, NV

I hereby acknowledge receipt of the above described materials Name (Print or Type) Signature Date Received 10-6-10

81 Environmental Tech
13550 N Highway 93
Las Vegas, NV 89165

Ticket Type: INBOUND INVOICE

Ticket Number: 1866
Date: 10/06/2010
Time In: 10:32 pm
Time Out: 10:54 pm

Customer: 001011 - NGE, LLC c/o Northgate Environ Mgmt

Vehicle/Container: 86053P
Contract: Northgate Env. On Site Soils 3825 11
Comment: 3825 10 11244

Gross Weight: 129,020 LB Manual In
Tare Weight: 57,680 LB Manual Out
Net Weight: 71340 LB
Net Tons: 35.67

BOL: 11958

Origin	Yards	Material	Billing	Quantity
Not Applicable	0.00 YD	SW CONTAMINATED SOIL	35.67	TN

Driver: 

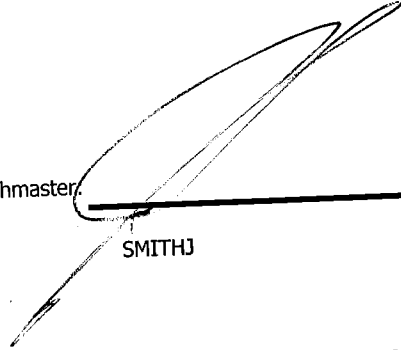
Weighmaster: 
SMITHJ

Indemnification. Customer agrees, by signature above, to indemnify, hold harmless, and defend Republic Services, Inc., its subsidiaries, affiliates, employees, officers and directors from and against any and all liabilities, claims, penalties, forfeitures, suits and the costs and expenses incident thereto, including costs of defense, settlement, and reasonable attorney's fees, which may be incurred, as a result of death or injuries to any person, or damage to any property, contamination of or adverse effects on the environment, caused in whole or in part by the Customer, its employees, or subcontractors in disposing waste at this Facility. In the event Customer delivers Unacceptable Waste (as determined by Republic) Customer agrees to assume all expenses and obligations with the removal and/or resolution of any effects caused by the delivery of such Unacceptable Waste.

Indemnización. Cliente acuerda indemnizar, mantener inmune, y defender Republic Services, Inc., sus subsidiarios, compañías, divisiones, empleados, oficiales y directores contra de cualquiera y de todas responsabilidades, demandas, penas, pérdidas, juicios, pleitos y los costos incidente además, incluyendo costos de defensa, de acuerdo judicial, y de honorarios razonables del abogado, que pueden ser incurridos en, o como resultado de, la muerte o herida personal a cualquier persona, o daños a cualquier característica, propiedad, contaminación de la tierra o efectos ilícitos en esta Facilidad, causado entero o en parte por el cliente, sus empleados, o sus subcontratistas en botar basura en esta Facilidad. En el caso que el Cliente entrega, bota, basura (según lo determinado por Republic) en este Establecimiento basura inaceptable en los reglamentos de este Establecimiento, el Cliente se compromete asumir todos los costos y obligaciones con el retiro y/o la resolución de cualquier dano(s) causado por la entrega de tal basura inaceptable.



NON-HAZARDOUS WASTE MANIFEST

MANIFEST # 11958

GENERATOR INFORMATION

Generator Name: Tronox LLC

Address: P.O. Box 55

City: Henderson County: Clark

State: NV Zip: 89009

Site Location (if different): 560 W. Lake Mead

Henderson, NV 89015 (702) 592-7727

CUSTOMER/BILLING INFORMATION

Billing Name: NGE LLC c/o Northgate Environment Management

Address: 300 Frank Ogawa Plaza, Ste 510

City: Oakland County: Alameda

State: CA Zip: 94612

Republic Services Approval #	Description of Waste	Volume/Weight	Expiration Date	Container Type
38251011244	Soil for disposal		12-31-2011	Tractor with Dump Trailer(s)
	RZ- _____ # _____	35.67 TO		

*Attach Additional Sheet if necessary

I hereby certify that the above-described materials are non-hazardous wastes as defined by 40 CFR 261 or any applicable state law. Further, that the above named materials are properly classified, described, packaged, marked and labeled, and are in proper condition for transportation according to the applicable regulations of the Department of Transportation.

Susan Crowley [Signature] _____
 Generator/Authorized Agent Name Signature Date Shipped

TRANSPORTER INFORMATION

Transporter Name: Las Vegas Paving

DOT # 191949

Address: 4420 S. Decatur

Truck Number: 261

Las Vegas, NV 89103

Phone Number: (702) 353-4355

I certify no hazardous waste or other regulated substance was knowingly introduced to the waste while in my custody. The waste transported in this vehicle is the waste identified above, to the best of my knowledge.

[Signature] Patrick Jones 6/21/11
 Name of Authorized Agent Signature Date Delivered

DISPOSAL SITE INFORMATION

Site Name: Apex Regional Landfill

Phone No. (702) 599-5920

Address: 13550 U.S. Hwy 93 Las Vegas, NV

I hereby acknowledge receipt of the above described materials
[Signature] _____
 Name (Print or Type) Signature Date Received

81 Environmental Tech
13550 N Highway 93
Las Vegas, NV 89165

Ticket Type: INBOUND INVOICE

Ticket Number: 1867
Date: 10/06/2010
Time In: 10:40 pm
Time Out: 11:02 pm

Customer: 001011 - NGE, LLC c/o Northgate Environ Mgmt

Vehicle/Container: 76810P
Contract: Northgate Env. On Site Soils 3825 10
Comment: 3825 10 11244

Gross Weight: 124,960 LB Manual In
Tare Weight: 56,100 LB Manual Out
Net Weight: 68860 LB
Net Tons: 34.43

BOL: 11959

Origin	Yards	Material	Billing	Quantity
Not Applicable	0.00 YD	SW CONTAMINATED SOIL	34.43	TN

Driver:

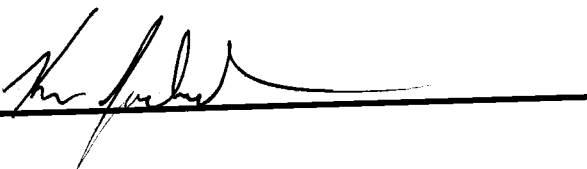

Weighmaster:

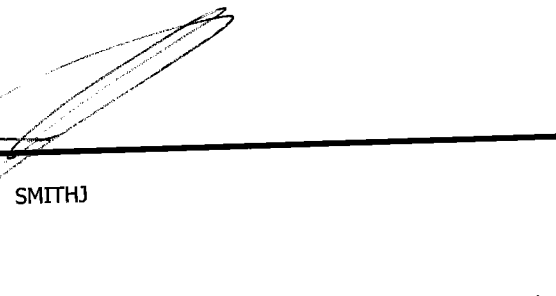

SMITHJ

Indemnification. Customer agrees, by signature above, to indemnify, hold harmless, and defend Republic Services, Inc., its subsidiaries, affiliates, employees, officers and directors from and against any and all liabilities, claims, penalties, forfeitures, suits and the costs and expenses incident thereto, including costs of defense, settlement, and reasonable attorney's fees, which may be incurred, as a result of death or injuries to any person, or damage to any property, contamination of or adverse effects on the environment, caused in whole or in part by the Customer, its employees, or subcontractors in disposing waste at this Facility. In the event Customer delivers Unacceptable Waste (as determined by Republic) Customer agrees to assume all expenses and obligations with the removal and/or resolution of any effects caused by the delivery of such Unacceptable Waste.

Indemnización. Cliente acuerda indemnizar, mantener inmune, y defender Republic Services, Inc., sus subsidiarios, compañías, divisiones, empleados, oficiales y directores contra de cualquiera y de todas responsabilidades, demandas, penas, pérdidas, juicios, pleitos y los costos incidente además, incluyendo costos de defensa, de acuerdo judicial, y de honorarios razonables del abogado, que pueden ser incurridos en, o como resultado de, la muerte o herida personal a cualquier persona, o daños a cualquier característica, propiedad, contaminación de la tierra o efectos ilícitos en esta Facilidad, causado entero o en parte por el cliente, sus empleados, o sus subcontratistas en botar basura en esta Facilidad. En el caso que el Cliente entrega, bota, basura (según lo determinado por Republic) en este Establecimiento basura inaceptable en los reglamentos de este Establecimiento, el Cliente se compromete asumir todos los costos y obligaciones con el retiro y/o la resolución de cualquier dano(s) causado por la entrega de tal basura inaceptable.



NON-HAZARDOUS WASTE MANIFEST

MANIFEST # 11959

GENERATOR INFORMATION

Generator Name: Tronox LLC

Address: P.O. Box 55

City: Henderson County: Clark

State: NV Zip: 89009

Site Location (if different): 560 W. Lake Mead
Henderson, NV 89015 (702) 592-7727

CUSTOMER/BILLING INFORMATION

Billing Name: NGE LLC c/o Northgate Environment Management

Address: 300 Frank Ogawa Plaza, Ste 510

City: Oakland County: Alameda

State: CA Zip: 94612

Republic Services Approval #	Description of Waste	Volume/Weight	Expiration Date	Container Type
38251011244	Soil for disposal		12-31-2011	Tractor with Dump Trailer(s)
	RZ-_____ # _____	34.43 TON		

*Attach Additional Sheet if necessary

I hereby certify that the above-described materials are non-hazardous wastes as defined by 40 CFR 261 or any applicable state law. Further, that the above named materials are properly classified, described, packaged, marked and labeled, and are in proper condition for transportation according to the applicable regulations of the Department of Transportation.

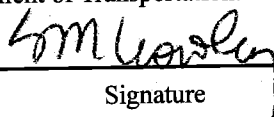
Susan Crowley  _____
 Generator/Authorized Agent Name Signature Date Shipped

TRANSPORTER INFORMATION

Transporter Name: Las Vegas Paving

DOT # 191949

Address: 4420 S. Decatur

Truck Number: 241

Las Vegas, NV 89103

Phone Number: (702) 353-4355

I certify no hazardous waste or other regulated substance was knowingly introduced to the waste while in my custody. The waste transported in this vehicle is the waste identified above, to the best of my knowledge.

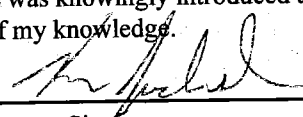
Ken Jackson  _____ 10-6-2010
 Name of Authorized Agent Signature Date Delivered

DISPOSAL SITE INFORMATION

Site Name: Apex Regional Landfill

Phone No. (702) 599-5920

Address: 13550 U.S. Hwy 93 Las Vegas, NV

I hereby acknowledge receipt of the above described materials

Joe Smith _____ 10-6-10
 Name (Print or Type) Signature Date Received

81 Environmental Tech
13550 N Highway 93
Las Vegas, NV 89165

Ticket Type: INBOUND INVOICE

Ticket Number: 1868
Date: 10/06/2010
Time In: 10:45 pm
Time Out: 11:09 pm

Customer: 001011 - NGE, LLC c/o Northgate Environ Mgmt

Vehicle/Container: 68263P
Contract: Northgate Env. On Site Soils 3825 10
Comment: 3825 10 11244

Gross Weight: 125,160 LB Manual In
Tare Weight: 53,600 LB Manual Out
Net Weight: 71560 LB
Net Tons: 35.78

BOL: 11960

Origin	Yards	Material	Billing	Quantity
Not Applicable	0.00 YD	SW CONTAMINATED SOIL	35.78	TN

Driver: _____

Weighmaster: _____

SMITHJ

Indemnification. Customer agrees, by signature above, to indemnify, hold harmless, and defend Republic Services, Inc., its subsidiaries, affiliates, employees, officers and directors from and against any and all liabilities, claims, penalties, forfeitures, suits and the costs and expenses incident thereto, including costs of defense, settlement, and reasonable attorney's fees, which may be incurred, as a result of death or injuries to any person, or damage to any property, contamination of or adverse effects on the environment, caused in whole or in part by the Customer, its employees, or subcontractors in disposing waste at this Facility. In the event Customer delivers Unacceptable Waste (as determined by Republic) Customer agrees to assume all expenses and obligations with the removal and/or resolution of any effects caused by the delivery of such Unacceptable Waste.

Indemnización. Cliente acuerda indemnizar, mantener inmune, y defender Republic Services, Inc., sus subsidiarios, compañías, divisiones, empleados, oficiales y directores contra de cualquiera y de todas responsabilidades, demandas, penas, pérdidas, juicios, pleitos y los costos incidente además, incluyendo costos de defensa, de acuerdo judicial, y de honorarios razonables del abogado, que pueden ser incurridos en, o como resultado de, la muerte o herida personal a cualquier persona, o daños a cualquier característica, propiedad, contaminación de la tierra o efectos ilícitos en esta Facilidad, causado entero o en parte por el cliente, sus empleados, o sus subcontratistas en botar basura en esta Facilidad. En el caso que el Cliente entrega, bota, basura (según lo determinado por Republic) en este Establecimiento basura inaceptable en los reglamentos de este Establecimiento, el Cliente se compromete asumir todos los costos y obligaciones con el retiro y/o la resolución de cualquier dano(s) causado por la entrega de tal basura inaceptable.



NON-HAZARDOUS WASTE MANIFEST

MANIFEST # 11960

GENERATOR INFORMATION

Generator Name: Tronox LLC
Address: P.O. Box 55
City: Henderson County: Clark
State: NV Zip: 89009
Site Location (if different): 560 W. Lake Mead
Henderson, NV 89015 (702) 592-7727

CUSTOMER/BILLING INFORMATION

Billing Name: NGE LLC c/o Northgate Environment Management
Address: 300 Frank Ogawa Plaza, Ste 510
City: Oakland County: Alameda
State: CA Zip: 94612

Table with 5 columns: Republic Services Approval #, Description of Waste, Volume/Weight, Expiration Date, Container Type. Row 1: 38251011244, Soil for disposal, 35.78 90, 12-31-2011, Tractor with Dump Trailer(s)

*Attach Additional Sheet if necessary

I hereby certify that the above-described materials are non-hazardous wastes as defined by 40 CFR 261 or any applicable state law. Further, that the above named materials are properly classified, described, packaged, marked and labeled, and are in proper condition for transportation according to the applicable regulations of the Department of Transportation.

Susan Crowley
Generator/Authorized Agent Name Signature Date Shipped

TRANSPORTER INFORMATION

Transporter Name: Las Vegas Paving DOT # 191949
Address: 4420 S. Decatur Truck Number: 2711
Las Vegas, NV 89103 Phone Number: (702) 353-4355

I certify no hazardous waste or other regulated substance was knowingly introduced to the waste while in my custody. The waste transported in this vehicle is the waste identified above, to the best of my knowledge.

STEVEN MAYES
Name of Authorized Agent Signature Date Delivered 10-6-10

DISPOSAL SITE INFORMATION

Site Name: Apex Regional Landfill Phone No. (702) 599-5920
Address: 13550 U.S. Hwy 93 Las Vegas, NV

I hereby acknowledge receipt of the above described materials
Name (Print or Type) Signature Date Received 10-6-10

81 Environmental Tech
13550 N Highway 93
Las Vegas, NV 89165

Ticket Type: INBOUND INVOICE

Ticket Number: 1869
Date: 10/06/2010
Time In: 10:47 pm
Time Out: 11:11 pm

Customer: 001011 - NGE, LLC c/o Northgate Environ Mgmt

Vehicle/Container: 76811P
Contract: Northgate Env. On Site Soils 3825 11
Comment: 3825 10 11244

Gross Weight: 126,360 LB Manual In
Tare Weight: 50,540 LB Manual Out
Net Weight: 75820 LB
Net Tons: 37.91

BOL: 11961

Origin	Yards	Material	Billing	Quantity
Not Applicable	0.00 YD	SW CONTAMINATED SOIL	37.91	TN

Driver:



Weighmaster:

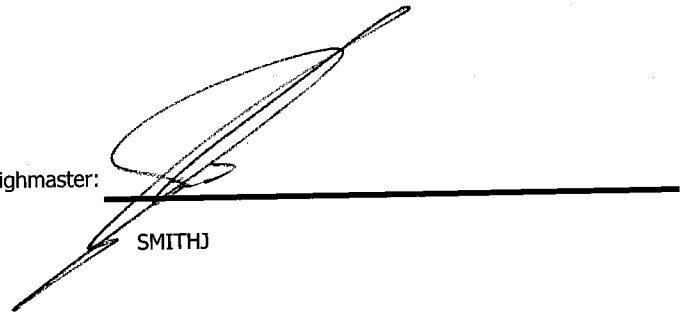

SMITHJ

Indemnification. Customer agrees, by signature above, to indemnify, hold harmless, and defend Republic Services, Inc., its subsidiaries, affiliates, employees, officers and directors from and against any and all liabilities, claims, penalties, forfeitures, suits and the costs and expenses incident thereto, including costs of defense, settlement, and reasonable attorney's fees, which may be incurred, as a result of death or injuries to any person, or damage to any property, contamination of or adverse effects on the environment, caused in whole or in part by the Customer, its employees, or subcontractors in disposing waste at this Facility. In the event Customer delivers Unacceptable Waste (as determined by Republic) Customer agrees to assume all expenses and obligations with the removal and/or resolution of any effects caused by the delivery of such Unacceptable Waste.

Indemnización. Cliente acuerda indemnizar, mantener inmune, y defender Republic Services, Inc., sus subsidiarios, compañías, divisiones, empleados, oficiales y directores contra de cualquiera y de todas responsabilidades, demandas, penas, pérdidas, juicios, pleitos y los costos incidente además, incluyendo costos de defensa, de acuerdo judicial, y de honorarios razonables del abogado, que pueden ser incurridos en, o como resultado de, la muerte o herida personal a cualquier persona, o daños a cualquier característica, propiedad, contaminación de la tierra o efectos ilícitos en esta Facilidad, causado entero o en parte por el cliente, sus empleados, o sus subcontratistas en botar basura en esta Facilidad. En el caso que el Cliente entrega, bota, basura (según lo determinado por Republic) en este Establecimiento basura inaceptable en los reglamentos de este Establecimiento, el Cliente se compromete asumir todos los costos y obligaciones con el retiro y/o la resolución de cualquier dano(s) causado por la entrega de tal basura inaceptable.



NON-HAZARDOUS WASTE MANIFEST

MANIFEST # 11961

GENERATOR INFORMATION

Generator Name: Tronox LLC

Address: P.O. Box 55

City: Henderson County: Clark

State: NV Zip: 89009

Site Location (if different): 560 W. Lake Mead

Henderson, NV 89015 (702) 592-7727

CUSTOMER/BILLING INFORMATION

Billing Name: NGE LLC c/o Northgate Environment Management

Address: 300 Frank Ogawa Plaza, Ste 510

City: Oakland County: Alameda

State: CA Zip: 94612

Republic Services Approval #	Description of Waste	Volume/Weight	Expiration Date	Container Type
38251011244	Soil for disposal		12-31-2011	Tractor with Dump Trailer(s)
	RZ- _____ # _____	37.91 TON		

*Attach Additional Sheet if necessary

I hereby certify that the above-described materials are non-hazardous wastes as defined by 40 CFR 261 or any applicable state law. Further, that the above named materials are properly classified, described, packaged, marked and labeled, and are in proper condition for transportation according to the applicable regulations of the Department of Transportation.

Susan Crowley
Generator/Authorized Agent Name
Signature
Date Shipped

TRANSPORTER INFORMATION

Transporter Name: Las Vegas Paving

DOT # 191949

Address: 4420 S. Decatur

Truck Number: 242

Las Vegas, NV 89103

Phone Number: (702) 353-4355

I certify no hazardous waste or other regulated substance was knowingly introduced to the waste while in my custody. The waste transported in this vehicle is the waste identified above, to the best of my knowledge.

Mike Heffern
Name of Authorized Agent
Signature
Date Delivered 10-6-10

DISPOSAL SITE INFORMATION

Site Name: Apex Regional Landfill

Phone No. (702) 599-5920

Address: 13550 U.S. Hwy 93 Las Vegas, NV

I hereby acknowledge receipt of the above described materials
Name (Print or Type)
Signature
Date Received

81 Environmental Tech
13550 N Highway 93
Las Vegas, NV 89165

Ticket Type: INBOUND INVOICE

Ticket Number: 1870
Date: 10/06/2010
Time In: 10:56 pm
Time Out: 11:24 pm

Customer: 001011 - NGE, LLC c/o Northgate Environ Mgmt

Vehicle/Container: 43073A
Contract: Northgate Env. On Site Soils 3825 11
Comment: 3825 10 11244

Gross Weight: 125,800 LB Manual In
Tare Weight: 55,960 LB Manual Out
Net Weight: 69840 LB
Net Tons: 34.92

BOL: 11962

Origin	Yards	Material	Billing Quantity
Not Applicable	0.00 YD	SW CONTAMINATED SOIL	34.92 TN

Driver: _____

Weighmaster: _____

SMITHJ

Indemnification. Customer agrees, by signature above, to indemnify, hold harmless, and defend Republic Services, Inc., its subsidiaries, affiliates, employees, officers and directors from and against any and all liabilities, claims, penalties, forfeitures, suits and the costs and expenses incident thereto, including costs of defense, settlement, and reasonable attorney's fees, which may be incurred, as a result of death or injuries to any person, or damage to any property, contamination of or adverse effects on the environment, caused in whole or in part by the Customer, its employees, or subcontractors in disposing waste at this Facility. In the event Customer delivers Unacceptable Waste (as determined by Republic) Customer agrees to assume all expenses and obligations with the removal and/or resolution of any effects caused by the delivery of such Unacceptable Waste.

Indemnización. Cliente acuerda indemnizar, mantener inmune, y defender Republic Services, Inc., sus subsidiarios, compañías, divisiones, empleados, oficiales y directores contra de cualquiera y de todas responsabilidades, demandas, penas, pérdidas, juicios, pleitos y los costos incidente además, incluyendo costos de defensa, de acuerdo judicial, y de honorarios razonables del abogado, que pueden ser incurridos en, o como resultado de, la muerte o herida personal a cualquier persona, o daños a cualquier característica, propiedad, contaminación de la tierra o efectos ilícitos en esta Facilidad, causado entero o en parte por el cliente, sus empleados, o sus subcontratistas en botar basura en esta Facilidad. En el caso que el Cliente entrega, bota, basura (según lo determinado por Republic) en este Establecimiento basura inaceptable en los reglamentos de este Establecimiento, el Cliente se compromete asumir todos los costos y obligaciones con el retiro y/o la resolución de cualquier dano(s) causado por la entrega de tal basura inaceptable.



NON-HAZARDOUS WASTE MANIFEST

MANIFEST # 11962

GENERATOR INFORMATION

Generator Name: Tronox LLC
 Address: P.O. Box 55
 City: Henderson County: Clark
 State: NV Zip: 89009
 Site Location (if different): 560 W. Lake Mead
Henderson, NV 89015 (702) 592-7727

CUSTOMER/BILLING INFORMATION

Billing Name: NGE LLC c/o Northgate Environment Management
 Address: 300 Frank Ogawa Plaza, Ste 510
 City: Oakland County: Alameda
 State: CA Zip: 94612

Republic Services Approval #	Description of Waste	Volume/Weight	Expiration Date	Container Type
38251011244	Soil for disposal		12-31-2011	Tractor with Dump Trailer(s)
	RZ- # _____	39.97 lb		

*Attach Additional Sheet if necessary

I hereby certify that the above-described materials are non-hazardous wastes as defined by 40 CFR 261 or any applicable state law. Further, that the above named materials are properly classified, described, packaged, marked and labeled, and are in proper condition for transportation according to the applicable regulations of the Department of Transportation.

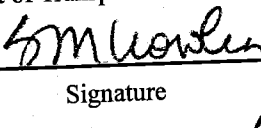
Susan Crowley 
 Generator/Authorized Agent Name Signature Date Shipped

TRANSPORTER INFORMATION

Transporter Name: Las Vegas Paving DOT # 191949
 Address: 4420 S. Decatur Truck Number: 89
Las Vegas, NV 89103 Phone Number: (702) 353-4355

I certify no hazardous waste or other regulated substance was knowingly introduced to the waste while in my custody. The waste transported in this vehicle is the waste identified above, to the best of my knowledge.

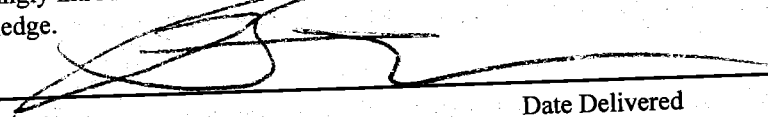
Brad Thomas 
 Name of Authorized Agent Signature Date Delivered

DISPOSAL SITE INFORMATION

Site Name: Apex Regional Landfill Phone No. (702) 599-5920
 Address: 13550 U.S. Hwy 93 Las Vegas, NV

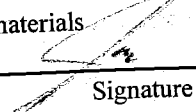
I hereby acknowledge receipt of the above described materials
Susan Crowley 
 Name (Print or Type) Signature Date Received

81 Environmental Tech
13550 N Highway 93
Las Vegas, NV 89165

Ticket Type: INBOUND INVOICE

Ticket Number: 1871
Date: 10/06/2010
Time In: 10:59 pm
Time Out: 11:25 pm

Customer: 001011 - NGE, LLC c/o Northgate Environ Mgmt

Vehicle/Container: 44165A
Contract: Northgate Env. On Site Soils 3825 11
Comment: 3825 10 11244

Gross Weight: 126,340 LB Manual In
Tare Weight: 48,920 LB Manual Out
Net Weight: 77,420 LB
Net Tons: 38.71

BOL: 11963

Origin	Yards	Material	Billing	Quantity
Not Applicable	0.00 YD	SW CONTAMINATED SOIL	38.71	TN

Driver: 

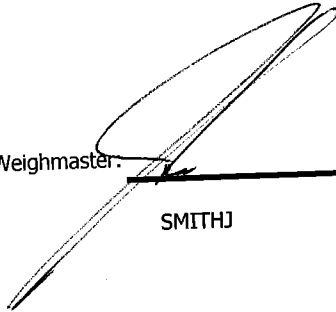
Weighmaster: 
SMITHJ

Indemnification. Customer agrees, by signature above, to indemnify, hold harmless, and defend Republic Services, Inc., its subsidiaries, affiliates, employees, officers and directors from and against any and all liabilities, claims, penalties, forfeitures, suits and the costs and expenses incident thereto, including costs of defense, settlement, and reasonable attorney's fees, which may be incurred, as a result of death or injuries to any person, or damage to any property, contamination of or adverse effects on the environment, caused in whole or in part by the Customer, its employees, or subcontractors in disposing waste at this Facility. In the event Customer delivers Unacceptable Waste (as determined by Republic) Customer agrees to assume all expenses and obligations with the removal and/or resolution of any effects caused by the delivery of such Unacceptable Waste.

Indemnización. Cliente acuerda indemnizar, mantener inmune, y defender Republic Services, Inc., sus subsidiarios, compañías, divisiones, empleados, oficiales y directores contra de cualquiera y de todas responsabilidades, demandas, penas, pérdidas, juicios, pleitos y los costos incidente además, incluyendo costos de defensa, de acuerdo judicial, y de honorarios razonables del abogado, que pueden ser incurridos en, o como resultado de, la muerte o herida personal a cualquier persona, o daños a cualquier característica, propiedad, contaminación de la tierra o efectos ilícitos en esta Facilidad, causado entero o en parte por el cliente, sus empleados, o sus subcontratistas en botar basura en esta Facilidad. En el caso que el Cliente entrega, bota, basura (según lo determinado por Republic) en este Establecimiento basura inaceptable en los reglamentos de este Establecimiento, el Cliente se compromete asumir todos los costos y obligaciones con el retiro y/o la resolución de cualquier dano(s) causado por la entrega de tal basura inaceptable.



NON-HAZARDOUS WASTE MANIFEST

MANIFEST # 11963

GENERATOR INFORMATION

Generator Name: Tronox LLC
Address: P.O. Box 55
City: Henderson County: Clark
State: NV Zip: 89009
Site Location (if different): 560 W. Lake Mead
Henderson, NV 89015 (702) 592-7727

CUSTOMER/BILLING INFORMATION

Billing Name: NGE LLC c/o Northgate Environment Management
Address: 300 Frank Ogawa Plaza, Ste 510
City: Oakland County: Alameda
State: CA Zip: 94612

Table with 5 columns: Republic Services Approval #, Description of Waste, Volume/Weight, Expiration Date, Container Type. Row 1: 38251011244, Soil for disposal, 38.75 Tons, 12-31-2011, Tractor with Dump Trailer(s). Row 2: RZ- #

*Attach Additional Sheet if necessary

I hereby certify that the above-described materials are non-hazardous wastes as defined by 40 CFR 261 or any applicable state law. Further, that the above named materials are properly classified, described, packaged, marked and labeled, and are in proper condition for transportation according to the applicable regulations of the Department of Transportation.

Susan Crowley
Generator/Authorized Agent Name Signature Date Shipped

TRANSPORTER INFORMATION

Transporter Name: Las Vegas Paving DOT # 191949
Address: 4420 S. Decatur Truck Number: K001
Las Vegas, NV 89103 Phone Number: (702) 353-4355

I certify no hazardous waste or other regulated substance was knowingly introduced to the waste while in my custody. The waste transported in this vehicle is the waste identified above, to the best of my knowledge.

CEBU
Name of Authorized Agent Signature Date Delivered 10/06/10

DISPOSAL SITE INFORMATION

Site Name: Apex Regional Landfill Phone No. (702) 599-5920
Address: 13550 U.S. Hwy 93 Las Vegas, NV

I hereby acknowledge receipt of the above described materials
Name (Print or Type) Signature Date Received 10-6-10

81 Environmental Tech
13550 N Highway 93
Las Vegas, NV 89165

Ticket Type: INBOUND INVOICE

Ticket Number: 1872
Date: 10/06/2010
Time In: 11:12 pm
Time Out: 11:39 pm

Customer: 001011 - NGE, LLC c/o Northgate Environ Mgmt

Vehicle/Container: 44564A
Contract: Northgate Env. On Site Soils 3825 1
Comment: 3825 10 11244

Gross Weight: 130,020 LB Manual In
Tare Weight: 49,520 LB Manual Out
Net Weight: 80500 LB
Net Tons: 40.25

BOL: 11964

Origin	Yards	Material	Billing	Quantity
Not Applicable	0.00 YD	SW CONTAMINATED SOIL	40.25	TN

Driver:



Weighmaster:

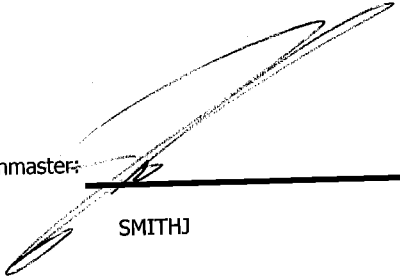

SMITHJ

Indemnification. Customer agrees, by signature above, to indemnify, hold harmless, and defend Republic Services, Inc., its subsidiaries, affiliates, employees, officers and directors from and against any and all liabilities, claims, penalties, forfeitures, suits and the costs and expenses incident thereto, including costs of defense, settlement, and reasonable attorney's fees, which may be incurred, as a result of death or injuries to any person, or damage to any property, contamination of or adverse effects on the environment, caused in whole or in part by the Customer, its employees, or subcontractors in disposing waste at this Facility. In the event Customer delivers Unacceptable Waste (as determined by Republic) Customer agrees to assume all expenses and obligations with the removal and/or resolution of any effects caused by the delivery of such Unacceptable Waste.

Indemnización. Cliente acuerda indemnizar, mantener inmune, y defender Republic Services, Inc., sus subsidiarios, compañías, divisiones, empleados, oficiales y directores contra de cualquiera y de todas responsabilidades, demandas, penas, pérdidas, juicios, pleitos y los costos incidente además, incluyendo costos de defensa, de acuerdo judicial, y de honorarios razonables del abogado, que pueden ser incurridos en, o como resultado de, la muerte o herida personal a cualquier persona, o daños a cualquier característica, propiedad, contaminación de la tierra o efectos ilícitos en esta Facilidad, causado entero o en parte por el cliente, sus empleados, o sus subcontratistas en botar basura en esta Facilidad. En el caso que el Cliente entrega, bota, basura (según lo determinado por Republic) en este Establecimiento basura inaceptable en los reglamentos de este Establecimiento, el Cliente se compromete asumir todos los costos y obligaciones con el retiro y/o la resolución de cualquier dano(s) causado por la entrega de tal basura inaceptable.



NON-HAZARDOUS WASTE MANIFEST

MANIFEST # 11964

GENERATOR INFORMATION

Generator Name: Tronox LLC
Address: P.O. Box 55
City: Henderson County: Clark
State: NV Zip: 89009
Site Location (if different): 560 W. Lake Mead
Henderson, NV 89015 (702) 592-7727

CUSTOMER/BILLING INFORMATION

Billing Name: NGE LLC c/o Northgate Environment Management
Address: 300 Frank Ogawa Plaza, Ste 510
City: Oakland County: Alameda
State: CA Zip: 94612

Table with 5 columns: Republic Services Approval #, Description of Waste, Volume/Weight, Expiration Date, Container Type. Row 1: 38251011244, Soil for disposal, 40.25 TON, 12-31-2011, Tractor with Dump Trailer(s).

*Attach Additional Sheet if necessary

I hereby certify that the above-described materials are non-hazardous wastes as defined by 40 CFR 261 or any applicable state law. Further, that the above named materials are properly classified, described, packaged, marked and labeled, and are in proper condition for transportation according to the applicable regulations of the Department of Transportation.

Susan Crowley (Signature) 10/05/10 (Date Shipped)
Generator/Authorized Agent Name Signature Date Shipped

TRANSPORTER INFORMATION

Transporter Name: Las Vegas Paving DOT # 191949
Address: 4420 S. Decatur Truck Number: K003
Las Vegas, NV 89103 Phone Number: (702) 353-4355

I certify no hazardous waste or other regulated substance was knowingly introduced to the waste while in my custody. The waste transported in this vehicle is the waste identified above, to the best of my knowledge.

Ascencion (Signature) 10/05/10 (Date Delivered)
Name of Authorized Agent Signature Date Delivered

DISPOSAL SITE INFORMATION

Site Name: Apex Regional Landfill Phone No. (702) 599-5920
Address: 13550 U.S. Hwy 93 Las Vegas, NV

I hereby acknowledge receipt of the above described materials
Jose Smith (Signature) 10-6-10 (Date Received)
Name (Print or Type) Signature Date Received

81 Environmental Tech
13550 N Highway 93
Las Vegas, NV 89165

Ticket Type: INBOUND INVOICE

Ticket Number: 1873
Date: 10/06/2010
Time In: 11:40 pm
Time Out: 12:02 am

Customer: 001011 - NGE, LLC c/o Northgate Environ Mgmt

Vehicle/Container: 86113P
Contract: Northgate Env. On Site Soils 3825 11
Comment: 3825 10 11244

Gross Weight: 138,920 LB Manual In
Tare Weight: 55,380 LB Manual Out
Net Weight: 83540 LB
Net Tons: 41.77

BOL: 11965

Origin	Yards	Material	Billing	Quantity
Not Applicable	0.00 YD	SW CONTAMINATED SOIL	41.77	TN

Driver: JAH

Weighmaster: [Signature]

SMITHJ

Indemnification. Customer agrees, by signature above, to indemnify, hold harmless, and defend Republic Services, Inc., its subsidiaries, affiliates, employees, officers and directors from and against any and all liabilities, claims, penalties, forfeitures, suits and the costs and expenses incident thereto, including costs of defense, settlement, and reasonable attorney's fees, which may be incurred, as a result of death or injuries to any person, or damage to any property, contamination of or adverse effects on the environment, caused in whole or in part by the Customer, its employees, or subcontractors in disposing waste at this Facility. In the event Customer delivers Unacceptable Waste (as determined by Republic) Customer agrees to assume all expenses and obligations with the removal and/or resolution of any effects caused by the delivery of such Unacceptable Waste.

Indemnización. Cliente acuerda indemnizar, mantener inmune, y defender Republic Services, Inc., sus subsidiarios, compañías, divisiones, empleados, oficiales y directores contra de cualquiera y de todas responsabilidades, demandas, penas, pérdidas, juicios, pleitos y los costos incidente además, incluyendo costos de defensa, de acuerdo judicial, y de honorarios razonables del abogado, que pueden ser incurridos en, o como resultado de, la muerte o herida personal a cualquier persona, o daños a cualquier característica, propiedad, contaminación de la tierra o efectos ilícitos en esta Facilidad, causado entero o en parte por el cliente, sus empleados, o sus subcontratistas en botar basura en esta Facilidad. En el caso que el Cliente entrega, bota, basura (según lo determinado por Republic) en este Establecimiento basura inaceptable en los reglamentos de este Establecimiento, el Cliente se compromete asumir todos los costos y obligaciones con el retiro y/o la resolución de cualquier dano(s) causado por la entrega de tal basura inaceptable.



NON-HAZARDOUS WASTE MANIFEST

MANIFEST # 11965

GENERATOR INFORMATION

Generator Name: Tronox LLC

Address: P.O. Box 55

City: Henderson County: Clark

State: NV Zip: 89009

Site Location (if different): 560 W. Lake Mead

Henderson, NV 89015 (702) 592-7727

CUSTOMER/BILLING INFORMATION

Billing Name: NGE LLC c/o Northgate Environment Management

Address: 300 Frank Ogawa Plaza, Ste 510

City: Oakland County: Alameda

State: CA Zip: 94612

Republic Services Approval #	Description of Waste	Volume/Weight	Expiration Date	Container Type
38251011244	Soil for disposal		12-31-2011	Tractor with Dump Trailer(s)
	RZ- _____ # _____	41.77 TON		

*Attach Additional Sheet if necessary

I hereby certify that the above-described materials are non-hazardous wastes as defined by 40 CFR 261 or any applicable state law. Further, that the above named materials are properly classified, described, packaged, marked and labeled, and are in proper condition for transportation according to the applicable regulations of the Department of Transportation.

Susan Crowley
Generator/Authorized Agent Name

Susan Crowley
Signature

Date Shipped

TRANSPORTER INFORMATION

Transporter Name: Las Vegas Paving

DOT # 191949

Address: 4420 S. Decatur

Truck Number: KMSA K0019/7

Las Vegas, NV 89103

Phone Number: (702) 353-4355

I certify no hazardous waste or other regulated substance was knowingly introduced to the waste while in my custody. The waste transported in this vehicle is the waste identified above, to the best of my knowledge.

AUBERTO
Name of Authorized Agent

Auberto H.
Signature

Oct 6, 2010
Date Delivered

DISPOSAL SITE INFORMATION

Site Name: Apex Regional Landfill

Phone No. (702) 599-5920

Address: 13550 U.S. Hwy 93 Las Vegas, NV

I hereby acknowledge receipt of the above described materials

JASON SMITH
Name (Print or Type)

Jason Smith
Signature

10-6-10
Date Received

81 Environmental Tech
13550 N Highway 93
Las Vegas, NV 89165

Ticket Type: INBOUND INVOICE

Ticket Number: 1874
Date: 10/06/2010
Time In: 11:47 pm
Time Out: 12:14 am

Customer: 001011 - NGE, LLC c/o Northgate Environ Mgmt

Vehicle/Container: 85887P
Contract: Northgate Env. On Site Soils 3825 11
Comment: 3825 10 11244

Gross Weight: 132,740 LB Manual In
Tare Weight: 51,620 LB Manual Out
Net Weight: 81,120 LB
Net Tons: 40.56

BOL: 11966

Origin	Yards	Material	Billing Quantity
Not Applicable	0.00 YD	SW CONTAMINATED SOIL	40.56 TN

Driver:

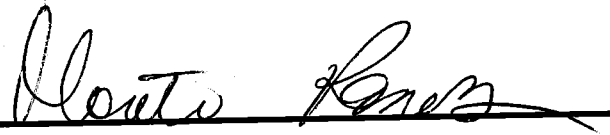

Weighmaster:

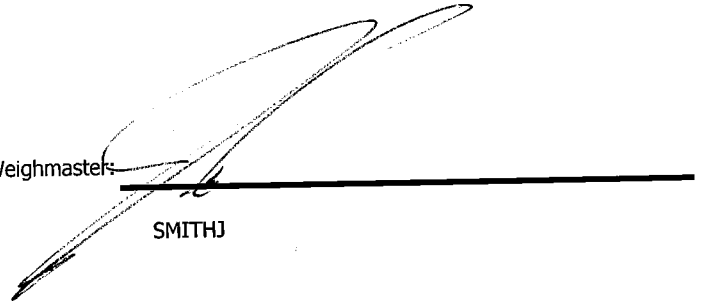

SMITHJ

Indemnification. Customer agrees, by signature above, to indemnify, hold harmless, and defend Republic Services, Inc., its subsidiaries, affiliates, employees, officers and directors from and against any and all liabilities, claims, penalties, forfeitures, suits and the costs and expenses incident thereto, including costs of defense, settlement, and reasonable attorney's fees, which may be incurred, as a result of death or injuries to any person, or damage to any property, contamination of or adverse effects on the environment, caused in whole or in part by the Customer, its employees, or subcontractors in disposing waste at this Facility. In the event Customer delivers Unacceptable Waste (as determined by Republic) Customer agrees to assume all expenses and obligations with the removal and/or resolution of any effects caused by the delivery of such Unacceptable Waste.

Indemnización. Cliente acuerda indemnizar, mantener inmune, y defender Republic Services, Inc., sus subsidiarios, compañías, divisiones, empleados, oficiales y directores contra de cualquiera y de todas responsabilidades, demandas, penas, pérdidas, juicios, pleitos y los costos incidente además, incluyendo costos de defensa, de acuerdo judicial, y de honorarios razonables del abogado, que pueden ser incurridos en, o como resultado de, la muerte o herida personal a cualquier persona, o daños a cualquier característica, propiedad, contaminación de la tierra o efectos ilícitos en esta Facilidad, causado entero o en parte por el cliente, sus empleados, o sus subcontratistas en botar basura en esta Facilidad. En el caso que el Cliente entrega, bota, basura (según lo determinado por Republic) en este Establecimiento basura inaceptable en los reglamentos de este Establecimiento, el Cliente se compromete asumir todos los costos y obligaciones con el retiro y/o la resolución de cualquier dano(s) causado por la entrega de tal basura inaceptable.



NON-HAZARDOUS WASTE MANIFEST

MANIFEST # 11966

GENERATOR INFORMATION

Generator Name: Tronox LLCAddress: P.O. Box 55City: Henderson County: ClarkState: NV Zip: 89009Site Location (if different): 560 W. Lake MeadHenderson, NV 89015 (702) 592-7727

CUSTOMER/BILLING INFORMATION

Billing Name: NGE LLC c/o Northgate Environment ManagementAddress: 300 Frank Ogawa Plaza, Ste 510City: Oakland County: AlamedaState: CA Zip: 94612

Republic Services Approval #	Description of Waste	Volume/Weight	Expiration Date	Container Type
38251011244	Soil for disposal		12-31-2011	Tractor with Dump Trailer(s)
	RZ- _____ # _____	40.56 TON		

*Attach Additional Sheet if necessary

I hereby certify that the above-described materials are non-hazardous wastes as defined by 40 CFR 261 or any applicable state law. Further, that the above named materials are properly classified, described, packaged, marked and labeled, and are in proper condition for transportation according to the applicable regulations of the Department of Transportation.

Susan Crowley _____
 Generator/Authorized Agent Name Signature Date Shipped

TRANSPORTER INFORMATION

Transporter Name: Las Vegas PavingDOT # 191949Address: 4420 S. DecaturTruck Number: R01Las Vegas, NV 89103Phone Number: (702) 353-4355

I certify no hazardous waste or other regulated substance was knowingly introduced to the waste while in my custody. The waste transported in this vehicle is the waste identified above, to the best of my knowledge.

 Name of Authorized Agent Signature Date Delivered

DISPOSAL SITE INFORMATION

Site Name: Apex Regional LandfillPhone No. (702) 599-5920Address: 13550 U.S. Hwy 93 Las Vegas, NV

I hereby acknowledge receipt of the above described materials
[Signature] _____
 Name (Print or Type) Signature Date Received

81 Environmental Tech
13550 N Highway 93
Las Vegas, NV 89165

Ticket Type: INBOUND INVOICE

Ticket Number: 1875
Date: 10/06/2010
Time In: 11:50 pm
Time Out: 12:17 am

Customer: 001011 - NGE, LLC c/o Northgate Environ Mgmt

Vehicle/Container: 192457
Contract: Northgate Env. On Site Soils 3825 11
Comment: 3825 10 11244

Gross Weight: 128,280 LB Manual In
Tare Weight: 55,860 LB Manual Out
Net Weight: 72420 LB
Net Tons: 36.21

BOL: 11967

Origin	Yards	Material	Billing	Quantity
Not Applicable	0.00 YD	SW CONTAMINATED SOIL	36.21 TN	

Driver: 

Weighmaster: 

SMITHJ

Indemnification. Customer agrees, by signature above, to indemnify, hold harmless, and defend Republic Services, Inc., its subsidiaries, affiliates, employees, officers and directors from and against any and all liabilities, claims, penalties, forfeitures, suits and the costs and expenses incident thereto, including costs of defense, settlement, and reasonable attorney's fees, which may be incurred, as a result of death or injuries to any person, or damage to any property, contamination of or adverse effects on the environment, caused in whole or in part by the Customer, its employees, or subcontractors in disposing waste at this Facility. In the event Customer delivers Unacceptable Waste (as determined by Republic) Customer agrees to assume all expenses and obligations with the removal and/or resolution of any effects caused by the delivery of such Unacceptable Waste.

Indemnización. Cliente acuerda indemnizar, mantener inmune, y defender Republic Services, Inc., sus subsidiarios, compañías, divisiones, empleados, oficiales y directores contra de cualquiera y de todas responsabilidades, demandas, penas, pérdidas, juicios, pleitos y los costos incidente además, incluyendo costos de defensa, de acuerdo judicial, y de honorarios razonables del abogado, que pueden ser incurridos en, o como resultado de, la muerte o herida personal a cualquier persona, o daños a cualquier característica, propiedad, contaminación de la tierra o efectos ilícitos en esta Facilidad, causado entero o en parte por el cliente, sus empleados, o sus subcontratistas en botar basura en esta Facilidad. En el caso que el Cliente entrega, bota, basura (según lo determinado por Republic) en este Establecimiento basura inacceptable en los reglamentos de este Establecimiento, el Cliente se compromete asumir todos los costos y obligaciones con el retiro y/o la resolución de cualquier dano(s) causado por la entrega de tal basura inacceptable.



NON-HAZARDOUS WASTE MANIFEST

MANIFEST # 11967

GENERATOR INFORMATION

Generator Name: Tronox LLC
Address: P.O. Box 55
City: Henderson County: Clark
State: NV Zip: 89009
Site Location (if different): 560 W. Lake Mead
Henderson, NV 89015 (702) 592-7727

CUSTOMER/BILLING INFORMATION

Billing Name: NGE LLC c/o Northgate Environment Management
Address: 300 Frank Ogawa Plaza, Ste 510
City: Oakland County: Alameda
State: CA Zip: 94612

Table with 5 columns: Republic Services Approval #, Description of Waste, Volume/Weight, Expiration Date, Container Type. Row 1: 38251011244, Soil for disposal, 20.00 cu yd, 12-31-2011, Tractor with Dump Trailer(s).

*Attach Additional Sheet if necessary

I hereby certify that the above-described materials are non-hazardous wastes as defined by 40 CFR 261 or any applicable state law. Further, that the above named materials are properly classified, described, packaged, marked and labeled, and are in proper condition for transportation according to the applicable regulations of the Department of Transportation.

Susan Crowley (Signature)
Generator/Authorized Agent Name Signature Date Shipped

TRANSPORTER INFORMATION

Transporter Name: Las Vegas Paving DOT # 191949
Address: 4420 S. Decatur Truck Number: 2457
Las Vegas, NV 89103 Phone Number: (702) 353-4355

I certify no hazardous waste or other regulated substance was knowingly introduced to the waste while in my custody. The waste transported in this vehicle is the waste identified above, to the best of my knowledge.

Brian Brinkhoff (Signature)
Name of Authorized Agent Signature Date Delivered 10-5-10

DISPOSAL SITE INFORMATION

Site Name: Apex Regional Landfill Phone No. (702) 599-5920
Address: 13550 U.S. Hwy 93 Las Vegas, NV

I hereby acknowledge receipt of the above described materials

(Signature)
Name (Print or Type) Signature Date Received 10-2-10

81 Environmental Tech
13550 N Highway 93
Las Vegas, NV 89165

Ticket Type: INBOUND INVOICE

Ticket Number: 1876
Date: 10/06/2010
Time In: 11:57 pm
Time Out: 12:21 am

Customer: 001011 - NGE, LLC c/o Northgate Environ Mgmt

Vehicle/Container: 44166A
Contract: Northgate Env. On Site Soils 3825 11
Comment: 3825 10 11244

Gross Weight: 136,140 LB Manual In
Tare Weight: 57,540 LB Manual Out
Net Weight: 78600 LB
Net Tons: 39.30

BOL: 11968

Origin	Yards	Material	Billing	Quantity
Not Applicable	0.00 YD	SW CONTAMINATED SOIL	39.30	TN

Driver: _____

Weighmaster: _____

SMITHJ

Indemnification. Customer agrees, by signature above, to indemnify, hold harmless, and defend Republic Services, Inc., its subsidiaries, affiliates, employees, officers and directors from and against any and all liabilities, claims, penalties, forfeitures, suits and the costs and expenses incident thereto, including costs of defense, settlement, and reasonable attorney's fees, which may be incurred, as a result of death or injuries to any person, or damage to any property, contamination of or adverse effects on the environment, caused in whole or in part by the Customer, its employees, or subcontractors in disposing waste at this Facility. In the event Customer delivers Unacceptable Waste (as determined by Republic) Customer agrees to assume all expenses and obligations with the removal and/or resolution of any effects caused by the delivery of such Unacceptable Waste.

Indemnización. Cliente acuerda indemnizar, mantener inmune, y defender Republic Services, Inc., sus subsidiarios, compañías, divisiones, empleados, oficiales y directores contra de cualquiera y de todas responsabilidades, demandas, penas, pérdidas, juicios, pleitos y los costos incidente además, incluyendo costos de defensa, de acuerdo judicial, y de honorarios razonables del abogado, que pueden ser incurridos en, o como resultado de, la muerte o herida personal a cualquier persona, o daños a cualquier característica, propiedad, contaminación de la tierra o efectos ilícitos en esta Facilidad, causado entero o en parte por el cliente, sus empleados, o sus subcontratistas en botar basura en esta Facilidad. En el caso que el Cliente entrega, bota, basura (según lo determinado por Republic) en este Establecimiento basura inaceptable en los reglamentos de este Establecimiento, el Cliente se compromete asumir todos los costos y obligaciones con el retiro y/o la resolución de cualquier dano(s) causado por la entrega de tal basura inaceptable.



NON-HAZARDOUS WASTE MANIFEST

MANIFEST # 11968

GENERATOR INFORMATION

Generator Name: Tronox LLC

Address: P.O. Box 55

City: Henderson County: Clark

State: NV Zip: 89009

Site Location (if different): 560 W. Lake Mead

Henderson, NV 89015 (702) 592-7727

CUSTOMER/BILLING INFORMATION

Billing Name: NGE LLC c/o Northgate Environment Management

Address: 300 Frank Ogawa Plaza, Ste 510

City: Oakland County: Alameda

State: CA Zip: 94612

Republic Services Approval #	Description of Waste	Volume/Weight	Expiration Date	Container Type
38251011244	Soil for disposal		12-31-2011	Tractor with Dump Trailer(s)
	RZ- _____ # _____	39.30 TN		

*Attach Additional Sheet if necessary

I hereby certify that the above-described materials are non-hazardous wastes as defined by 40 CFR 261 or any applicable state law. Further, that the above named materials are properly classified, described, packaged, marked and labeled, and are in proper condition for transportation according to the applicable regulations of the Department of Transportation.

Susan Crowley (Signature) Generator/Authorized Agent Name Date Shipped

TRANSPORTER INFORMATION

Transporter Name: Las Vegas Paving

DOT # 191949

Address: 4420 S. Decatur

Truck Number: K009

Las Vegas, NV 89103

Phone Number: (702) 353-4355

I certify no hazardous waste or other regulated substance was knowingly introduced to the waste while in my custody. The waste transported in this vehicle is the waste identified above, to the best of my knowledge.

Hugo Casella (Signature) Name of Authorized Agent Date Delivered 10-6-10

DISPOSAL SITE INFORMATION

Site Name: Apex Regional Landfill

Phone No. (702) 599-5920

Address: 13550 U.S. Hwy 93 Las Vegas, NV

I hereby acknowledge receipt of the above described materials (Signature) Name (Print or Type) Signature Date Received

81 Environmental Tech
13550 N Highway 93
Las Vegas, NV 89165

Ticket Type: INBOUND INVOICE

Ticket Number: 1879
Date: 10/06/2010
Time In: 11:57 pm
Time Out: 12:28 am

Customer: 001011 - NGE, LLC c/o Northgate Environ Mgmt

Vehicle/Container: 192460
Contract: Northgate Env. On Site Soils 3825 1/
Comment: 3825 10 11244

Gross Weight: 127,360 LB Manual In
Tare Weight: 53,440 LB Manual Out
Net Weight: 73920 LB
Net Tons: 36.96

BOL: 119969

Origin	Yards	Material	Billing	Quantity
Not Applicable	0.00 YD	SW CONTAMINATED SOIL	36.96	TN

Driver:

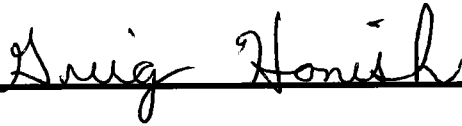

Weighmaster:



SMITHJ

Indemnification. Customer agrees, by signature above, to indemnify, hold harmless, and defend Republic Services, Inc., its subsidiaries, affiliates, employees, officers and directors from and against any and all liabilities, claims, penalties, forfeitures, suits and the costs and expenses incident thereto, including costs of defense, settlement, and reasonable attorney's fees, which may be incurred, as a result of death or injuries to any person, or damage to any property, contamination of or adverse effects on the environment, caused in whole or in part by the Customer, its employees, or subcontractors in disposing waste at this Facility. In the event Customer delivers Unacceptable Waste (as determined by Republic) Customer agrees to assume all expenses and obligations with the removal and/or resolution of any effects caused by the delivery of such Unacceptable Waste.

Indemnización. Cliente acuerda indemnizar, mantener inmune, y defender Republic Services, Inc., sus subsidiarios, compañías, divisiones, empleados, oficiales y directores contra de cualquiera y de todas responsabilidades, demandas, penas, pérdidas, juicios, pleitos y los costos incidente además, incluyendo costos de defensa, de acuerdo judicial, y de honorarios razonables del abogado, que pueden ser incurridos en, o como resultado de, la muerte o herida personal a cualquier persona, o daños a cualquier característica, propiedad, contaminación de la tierra o efectos ilícitos en esta Facilidad, causado entero o en parte por el cliente, sus empleados, o sus subcontratistas en botar basura en esta Facilidad. En el caso que el Cliente entrega, bota, basura (según lo determinado por Republic) en este Establecimiento basura inaceptable en los reglamentos de este Establecimiento, el Cliente se compromete asumir todos los costos y obligaciones con el retiro y/o la resolución de cualquier dano(s) causado por la entrega de tal basura inaceptable.



NON-HAZARDOUS WASTE MANIFEST

MANIFEST # 11969

GENERATOR INFORMATION

Generator Name: Tronox LLC

Address: P.O. Box 55

City: Henderson County: Clark

State: NV Zip: 89009

Site Location (if different): 560 W. Lake Mead

Henderson, NV 89015 (702) 592-7727

CUSTOMER/BILLING INFORMATION

Billing Name: NGE LLC c/o Northgate Environment Management

Address: 300 Frank Ogawa Plaza, Ste 510

City: Oakland County: Alameda

State: CA Zip: 94612

Republic Services Approval #	Description of Waste	Volume/Weight	Expiration Date	Container Type
38251011244	Soil for disposal		12-31-2011	Tractor with Dump Trailer(s)
	RZ- #	36.96 TN		

*Attach Additional Sheet if necessary

I hereby certify that the above-described materials are non-hazardous wastes as defined by 40 CFR 261 or any applicable state law. Further, that the above named materials are properly classified, described, packaged, marked and labeled, and are in proper condition for transportation according to the applicable regulations of the Department of Transportation.

Susan Crowley Generator/Authorized Agent Name Signature Date Shipped

TRANSPORTER INFORMATION

Transporter Name: Las Vegas Paving

DOT # 191949

Address: 4420 S. Decatur

Truck Number: 2460

Las Vegas, NV 89103

Phone Number: (702) 353-4355

I certify no hazardous waste or other regulated substance was knowingly introduced to the waste while in my custody. The waste transported in this vehicle is the waste identified above, to the best of my knowledge.

Greg Honish Name of Authorized Agent Signature Date Delivered 10-6-10

DISPOSAL SITE INFORMATION

Site Name: Apex Regional Landfill

Phone No. (702) 599-5920

Address: 13550 U.S. Hwy 93 Las Vegas, NV

I hereby acknowledge receipt of the above described materials Name (Print or Type) Signature Date Received

81 Environmental Tech
13550 N Highway 93
Las Vegas, NV 89165

Ticket Type: INBOUND INVOICE

Ticket Number: 1877
Date: 10/07/2010
Time In: 12:01 am
Time Out: 12:24 am

Customer: 001011 - NGE, LLC c/o Northgate Environ Mgmt

Vehicle/Container: 84598P

Contract: Northgate Env. On Site Soils 3825 11
Comment: 3825 10 11244

Gross Weight: 121,680 LB Manual In
Tare Weight: 52,000 LB Manual Out
Net Weight: 69680 LB
Net Tons: 34.84

BOL: 11970

Origin	Yards	Material	Billing	Quantity
Not Applicable	0.00 YD	SW CONTAMINATED SOIL	34.84	TN

Driver:

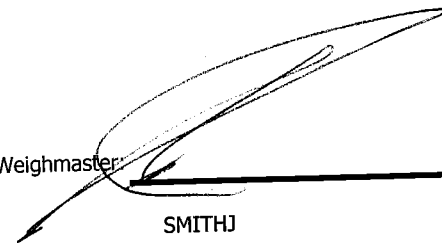

Weighmaster:

SMITHJ

Indemnification. Customer agrees, by signature above, to indemnify, hold harmless, and defend Republic Services, Inc., its subsidiaries, affiliates, employees, officers and directors from and against any and all liabilities, claims, penalties, forfeitures, suits and the costs and expenses incident thereto, including costs of defense, settlement, and reasonable attorney's fees, which may be incurred, as a result of death or injuries to any person, or damage to any property, contamination of or adverse effects on the environment, caused in whole or in part by the Customer, its employees, or subcontractors in disposing waste at this Facility. In the event Customer delivers Unacceptable Waste (as determined by Republic) Customer agrees to assume all expenses and obligations with the removal and/or resolution of any effects caused by the delivery of such Unacceptable Waste.

Indemnización. Cliente acuerda indemnizar, mantener inmune, y defender Republic Services, Inc., sus subsidiarios, compañías, divisiones, empleados, oficiales y directores contra de cualquiera y de todas responsabilidades, demandas, penas, pérdidas, juicios, pleitos y los costos incidente además, incluyendo costos de defensa, de acuerdo judicial, y de honorarios razonables del abogado, que pueden ser incurridos en, o como resultado de, la muerte o herida personal a cualquier persona, o daños a cualquier característica, propiedad, contaminación de la tierra o efectos ilícitos en esta Facilidad, causado entero o en parte por el cliente, sus empleados, o sus subcontratistas en botar basura en esta Facilidad. En el caso que el Cliente entrega, bota, basura (según lo determinado por Republic) en este Establecimiento basura inaceptable en los reglamentos de este Establecimiento, el Cliente se compromete asumir todos los costos y obligaciones con el retiro y/o la resolución de cualquier dano(s) causado por la entrega de tal basura inaceptable.



NON-HAZARDOUS WASTE MANIFEST

MANIFEST # 11970

GENERATOR INFORMATION

Generator Name: Tronox LLC
Address: P.O. Box 55
City: Henderson County: Clark
State: NV Zip: 89009
Site Location (if different): 560 W. Lake Mead
Henderson, NV 89015 (702) 592-7727

CUSTOMER/BILLING INFORMATION

Billing Name: NGE LLC c/o Northgate Environment Management
Address: 300 Frank Ogawa Plaza, Ste 510
City: Oakland County: Alameda
State: CA Zip: 94612

Table with 5 columns: Republic Services Approval #, Description of Waste, Volume/Weight, Expiration Date, Container Type. Row 1: 38251011244, Soil for disposal, 39.84 TON, 12-31-2011, Tractor with Dump Trailer(s).

*Attach Additional Sheet if necessary

I hereby certify that the above-described materials are non-hazardous wastes as defined by 40 CFR 261 or any applicable state law. Further, that the above named materials are properly classified, described, packaged, marked and labeled, and are in proper condition for transportation according to the applicable regulations of the Department of Transportation.

Susan Crowley (Signature)
Generator/Authorized Agent Name Signature Date Shipped

TRANSPORTER INFORMATION

Transporter Name: Las Vegas Paving DOT # 191949
Address: 4420 S. Decatur Truck Number: 28
Las Vegas, NV 89103 Phone Number: (702) 353-4355

I certify no hazardous waste or other regulated substance was knowingly introduced to the waste while in my custody. The waste transported in this vehicle is the waste identified above, to the best of my knowledge.

KRANGC (Signature)
Name of Authorized Agent Signature Date Delivered 10-6-10

DISPOSAL SITE INFORMATION

Site Name: Apex Regional Landfill Phone No. (702) 599-5920
Address: 13550 U.S. Hwy 93 Las Vegas, NV

I hereby acknowledge receipt of the above described materials

Name (Print or Type) Signature Date Received

81 Environmental Tech
13550 N Highway 93
Las Vegas, NV 89165

Ticket Type: INBOUND INVOICE

Ticket Number: 1878
Date: 10/07/2010
Time In: 12:01 am
Time Out: 12:25 am

Customer: 001011 - NGE, LLC c/o Northgate Environ Mgmt

Vehicle/Container: 192456
Contract: Northgate Env. On Site Soils 3825 11
Comment: 3825 10 11244

Gross Weight: 129,340 LB Manual In
Tare Weight: 53,220 LB Manual Out
Net Weight: 76,120 LB
Net Tons: 38.06

BOL: 11971

Origin	Yards	Material	Billing	Quantity
Not Applicable	0.00 YD	SW CONTAMINATED SOIL	38.06	TN

Driver: _____

Weighmaster: _____

SMITHJ

Indemnification. Customer agrees, by signature above, to indemnify, hold harmless, and defend Republic Services, Inc., its subsidiaries, affiliates, employees, officers and directors from and against any and all liabilities, claims, penalties, forfeitures, suits and the costs and expenses incident thereto, including costs of defense, settlement, and reasonable attorney's fees, which may be incurred, as a result of death or injuries to any person, or damage to any property, contamination of or adverse effects on the environment, caused in whole or in part by the Customer, its employees, or subcontractors in disposing waste at this Facility. In the event Customer delivers Unacceptable Waste (as determined by Republic) Customer agrees to assume all expenses and obligations with the removal and/or resolution of any effects caused by the delivery of such Unacceptable Waste.

Indemnización. Cliente acuerda indemnizar, mantener inmune, y defender Republic Services, Inc., sus subsidiarios, compañías, divisiones, empleados, oficiales y directores contra de cualquiera y de todas responsabilidades, demandas, penas, pérdidas, juicios, pleitos y los costos incidente además, incluyendo costos de defensa, de acuerdo judicial, y de honorarios razonables del abogado, que pueden ser incurridos en, o como resultado de, la muerte o herida personal a cualquier persona, o daños a cualquier característica, propiedad, contaminación de la tierra o efectos ilícitos en esta Facilidad, causado entero o en parte por el cliente, sus empleados, o sus subcontratistas en botar basura en esta Facilidad. En el caso que el Cliente entrega, bota, basura (según lo determinado por Republic) en este Establecimiento basura inaceptable en los reglamentos de este Establecimiento, el Cliente se compromete asumir todos los costos y obligaciones con el retiro y/o la resolución de cualquier dano(s) causado por la entrega de tal basura inaceptable.



NON-HAZARDOUS WASTE MANIFEST

MANIFEST # 11971

GENERATOR INFORMATION

Generator Name: Tronox LLC

Address: P.O. Box 55

City: Henderson County: Clark

State: NV Zip: 89009

Site Location (if different): 560 W. Lake Mead

Henderson, NV 89015 (702) 592-7727

CUSTOMER/BILLING INFORMATION

Billing Name: NGE LLC c/o Northgate Environment Management

Address: 300 Frank Ogawa Plaza, Ste 510

City: Oakland County: Alameda

State: CA Zip: 94612

Republic Services Approval #	Description of Waste	Volume/Weight	Expiration Date	Container Type
38251011244	Soil for disposal		12-31-2011	Tractor with Dump Trailer(s)
	RZ- _____ # _____	38.06 TIV		

*Attach Additional Sheet if necessary

I hereby certify that the above-described materials are non-hazardous wastes as defined by 40 CFR 261 or any applicable state law. Further, that the above named materials are properly classified, described, packaged, marked and labeled, and are in proper condition for transportation according to the applicable regulations of the Department of Transportation.

Susan Crowley
Generator/Authorized Agent Name

Susan Crowley
Signature

Date Shipped

TRANSPORTER INFORMATION

Transporter Name: Las Vegas Paving

DOT # 191949

Address: 4420 S. Decatur

Truck Number: 192456

Las Vegas, NV 89103

Phone Number: (702) 353-4355

I certify no hazardous waste or other regulated substance was knowingly introduced to the waste while in my custody. The waste transported in this vehicle is the waste identified above, to the best of my knowledge.

Blee
Name of Authorized Agent

Blee
Signature

10/6/10
Date Delivered

DISPOSAL SITE INFORMATION

Site Name: Apex Regional Landfill

Phone No. (702) 599-5920

Address: 13550 U.S. Hwy 93 Las Vegas, NV

I hereby acknowledge receipt of the above described materials

John Smith
Name (Print or Type)

John Smith
Signature

10-7-10
Date Received

81 Environmental Tech
13550 N Highway 93
Las Vegas, NV 89165

Ticket Type: INBOUND INVOICE

Ticket Number: 1880
Date: 10/07/2010
Time In: 12:15 am
Time Out: 12:38 am

Customer: 001011 - NGE, LLC c/o Northgate Environ Mgmt

Vehicle/Container: 81496P
Contract: Northgate Env. On Site Soils 3825 11
Comment: 3825 10 11244

Gross Weight: 128,920 LB Manual In
Tare Weight: 50,660 LB Manual Out
Net Weight: 78260 LB
Net Tons: 39.13

BOL: 11972

Origin	Yards	Material	Billing	Quantity
Not Applicable	0.00 YD	SW CONTAMINATED SOIL	39.13	TN

Driver: _____



Weighmaster: _____

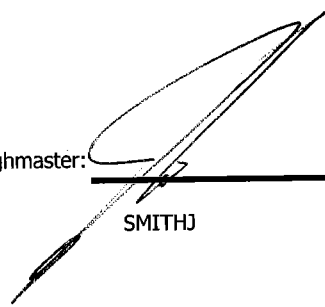

SMITHJ

Indemnification. Customer agrees, by signature above, to indemnify, hold harmless, and defend Republic Services, Inc., its subsidiaries, affiliates, employees, officers and directors from and against any and all liabilities, claims, penalties, forfeitures, suits and the costs and expenses incident thereto, including costs of defense, settlement, and reasonable attorney's fees, which may be incurred, as a result of death or injuries to any person, or damage to any property, contamination of or adverse effects on the environment, caused in whole or in part by the Customer, its employees, or subcontractors in disposing waste at this Facility. In the event Customer delivers Unacceptable Waste (as determined by Republic) Customer agrees to assume all expenses and obligations with the removal and/or resolution of any effects caused by the delivery of such Unacceptable Waste.

Indemnización. Cliente acuerda indemnizar, mantener inmune, y defender Republic Services, Inc., sus subsidiarios, compañías, divisiones, empleados, oficiales y directores contra de cualquiera y de todas responsabilidades, demandas, penas, pérdidas, juicios, pleitos y los costos incidente además, incluyendo costos de defensa, de acuerdo judicial, y de honorarios razonables del abogado, que pueden ser incurridos en, o como resultado de, la muerte o herida personal a cualquier persona, o daños a cualquier característica, propiedad, contaminación de la tierra o efectos ilícitos en esta Facilidad, causado entero o en parte por el cliente, sus empleados, o sus subcontratistas en botar basura en esta Facilidad. En el caso que el Cliente entrega, bota, basura (según lo determinado por Republic) en este Establecimiento basura inaceptable en los reglamentos de este Establecimiento, el Cliente se compromete asumir todos los costos y obligaciones con el retiro y/o la resolución de cualquier dano(s) causado por la entrega de tal basura inaceptable.



NON-HAZARDOUS WASTE MANIFEST

MANIFEST # 11972

GENERATOR INFORMATION

Generator Name: Tronox LLC
Address: P.O. Box 55
City: Henderson County: Clark
State: NV Zip: 89009
Site Location (if different): 560 W. Lake Mead
Henderson, NV 89015 (702) 592-7727

CUSTOMER/BILLING INFORMATION

Billing Name: NGE LLC c/o Northgate Environment Management
Address: 300 Frank Ogawa Plaza, Ste 510
City: Oakland County: Alameda
State: CA Zip: 94612

Table with 5 columns: Republic Services Approval #, Description of Waste, Volume/Weight, Expiration Date, Container Type. Row 1: 38251011244, Soil for disposal, 37.13 TON, 12-31-2011, Tractor with Dump Trailer(s).

*Attach Additional Sheet if necessary

I hereby certify that the above-described materials are non-hazardous wastes as defined by 40 CFR 261 or any applicable state law. Further, that the above named materials are properly classified, described, packaged, marked and labeled, and are in proper condition for transportation according to the applicable regulations of the Department of Transportation.

Susan Crowley (Signature)
Generator/Authorized Agent Name Signature Date Shipped

TRANSPORTER INFORMATION

Transporter Name: Las Vegas Paving DOT # 191949
Address: 4420 S. Decatur Truck Number: 145
Las Vegas, NV 89103 Phone Number: (702) 353-4355

I certify no hazardous waste or other regulated substance was knowingly introduced to the waste while in my custody. The waste transported in this vehicle is the waste identified above, to the best of my knowledge.

Harry M. Baird (Signature)
Name of Authorized Agent Signature Date Delivered 10-6-10

DISPOSAL SITE INFORMATION

Site Name: Apex Regional Landfill Phone No. (702) 599-5920
Address: 13550 U.S. Hwy 93 Las Vegas, NV

I hereby acknowledge receipt of the above described materials
Name (Print or Type) Signature Date Received 10-7-10

81 Environmental Tech
13550 N Highway 93
Las Vegas, NV 89165

Ticket Type: INBOUND INVOICE

Ticket Number: 1881
Date: 10/07/2010
Time In: 12:22 am
Time Out: 12:44 am

Customer: 001011 - NGE, LLC c/o Northgate Environ Mgmt

Vehicle/Container: 81495P
Contract: Northgate Env. On Site Soils 3825 11
Comment: 3825 10 11244

Gross Weight: 121,260 LB Manual In
Tare Weight: 53,340 LB Manual Out
Net Weight: 67920 LB
Net Tons: 33.96

BOL: 11973

Origin	Yards	Material	Billing Quantity
Not Applicable	0.00 YD	SW CONTAMINATED SOIL	33.96 TN

Driver: _____

Weighmaster: _____

SMITHJ

Indemnification. Customer agrees, by signature above, to indemnify, hold harmless, and defend Republic Services, Inc., its subsidiaries, affiliates, employees, officers and directors from and against any and all liabilities, claims, penalties, forfeitures, suits and the costs and expenses incident thereto, including costs of defense, settlement, and reasonable attorney's fees, which may be incurred, as a result of death or injuries to any person, or damage to any property, contamination of or adverse effects on the environment, caused in whole or in part by the Customer, its employees, or subcontractors in disposing waste at this Facility. In the event Customer delivers Unacceptable Waste (as determined by Republic) Customer agrees to assume all expenses and obligations with the removal and/or resolution of any effects caused by the delivery of such Unacceptable Waste.

Indemnización. Cliente acuerda indemnizar, mantener inmune, y defender Republic Services, Inc., sus subsidiarios, compañías, divisiones, empleados, oficiales y directores contra de cualquiera y de todas responsabilidades, demandas, penas, pérdidas, juicios, pleitos y los costos incidente además, incluyendo costos de defensa, de acuerdo judicial, y de honorarios razonables del abogado, que pueden ser incurridos en, o como resultado de, la muerte o herida personal a cualquier persona, o daños a cualquier característica, propiedad, contaminación de la tierra o efectos ilícitos en esta Facilidad, causado entero o en parte por el cliente, sus empleados, o sus subcontratistas en botar basura en esta Facilidad. En el caso que el Cliente entrega, bota, basura (según lo determinado por Republic) en este Establecimiento basura inaceptable en los reglamentos de este Establecimiento, el Cliente se compromete asumir todos los costos y obligaciones con el retiro y/o la resolución de cualquier dano(s) causado por la entrega de tal basura inaceptable.



SK 40236

NON-HAZARDOUS WASTE MANIFEST

MANIFEST # 11973

GENERATOR INFORMATION

Generator Name: Tronox LLC

Address: P.O. Box 55

City: Henderson County: Clark

State: NV Zip: 89009

Site Location (if different): 560 W. Lake Mead

Henderson, NV 89015 (702) 592-7727

CUSTOMER/BILLING INFORMATION

Billing Name: NGE LLC c/o Northgate Environment Management

Address: 300 Frank Ogawa Plaza, Ste 510

City: Oakland County: Alameda

State: CA Zip: 94612

Republic Services Approval #	Description of Waste	Volume/Weight	Expiration Date	Container Type
38251011244	Soil for disposal		12-31-2011	Tractor with Dump Trailer(s)
	RZ-_____#_____	33.96 TON		

*Attach Additional Sheet if necessary

I hereby certify that the above-described materials are non-hazardous wastes as defined by 40 CFR 261 or any applicable state law. Further, that the above named materials are properly classified, described, packaged, marked and labeled, and are in proper condition for transportation according to the applicable regulations of the Department of Transportation.

Susan Crowley [Signature] _____
 Generator/Authorized Agent Name Signature Date Shipped

TRANSPORTER INFORMATION

Transporter Name: Las Vegas Paving

DOT # 191949

Address: 4420 S. Decatur

Truck Number: 175

Las Vegas, NV 89103

Phone Number: (702) 353-4355

I certify no hazardous waste or other regulated substance was knowingly introduced to the waste while in my custody. The waste transported in this vehicle is the waste identified above, to the best of my knowledge.

Larry Herberger [Signature] 10-6-10
 Name of Authorized Agent Signature Date Delivered

DISPOSAL SITE INFORMATION

Site Name: Apex Regional Landfill

Phone No. (702) 599-5920

Address: 13550 U.S. Hwy 93 Las Vegas, NV

I hereby acknowledge receipt of the above described materials

[Signature] _____ 10-7-10
 Name (Print or Type) Signature Date Received

81 Environmental Tech
13550 N Highway 93
Las Vegas, NV 89165

Ticket Type: INBOUND INVOICE

Ticket Number: 1882
Date: 10/07/2010
Time In: 12:26 am
Time Out: 12:48 am

Customer: 001011 - NGE, LLC c/o Northgate Environ Mgmt

Vehicle/Container: 81494P
Contract: Northgate Env. On Site Soils 3825 11
Comment: 3825 10 11244

Gross Weight: 119,600 LB Manual In
Tare Weight: 51,580 LB Manual Out
Net Weight: 68020 LB
Net Tons: 34.01

BOL: 11974

Origin	Yards	Material	Billing	Quantity
Not Applicable	0.00 YD	SW CONTAMINATED SOIL	34.01	TN

Driver:



Weighmaster:

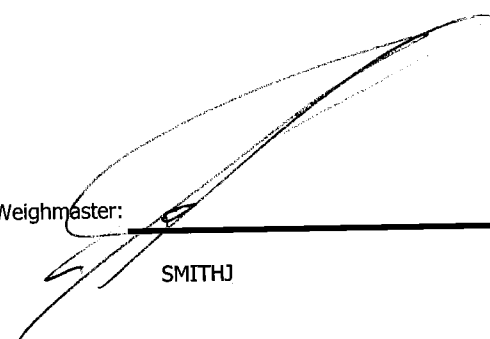

SMITHJ

Indemnification. Customer agrees, by signature above, to indemnify, hold harmless, and defend Republic Services, Inc., its subsidiaries, affiliates, employees, officers and directors from and against any and all liabilities, claims, penalties, forfeitures, suits and the costs and expenses incident thereto, including costs of defense, settlement, and reasonable attorney's fees, which may be incurred, as a result of death or injuries to any person, or damage to any property, contamination of or adverse effects on the environment, caused in whole or in part by the Customer, its employees, or subcontractors in disposing waste at this Facility. In the event Customer delivers Unacceptable Waste (as determined by Republic) Customer agrees to assume all expenses and obligations with the removal and/or resolution of any effects caused by the delivery of such Unacceptable Waste.

Indemnización. Cliente acuerda indemnizar, mantener inmune, y defender Republic Services, Inc., sus subsidiarios, compañías, divisiones, empleados, oficiales y directores contra de cualquiera y de todas responsabilidades, demandas, penas, pérdidas, juicios, pleitos y los costos incidente además, incluyendo costos de defensa, de acuerdo judicial, y de honorarios razonables del abogado, que pueden ser incurridos en, o como resultado de, la muerte o herida personal a cualquier persona, o daños a cualquier característica, propiedad, contaminación de la tierra o efectos ilícitos en esta Facilidad, causado entero o en parte por el cliente, sus empleados, o sus subcontratistas en botar basura en esta Facilidad. En el caso que el Cliente entrega, bota, basura (según lo determinado por Republic) en este Establecimiento basura inaceptable en los reglamentos de este Establecimiento, el Cliente se compromete asumir todos los costos y obligaciones con el retiro y/o la resolución de cualquier dano(s) causado por la entrega de tal basura inaceptable.



NON-HAZARDOUS WASTE MANIFEST

MANIFEST # 11974

GENERATOR INFORMATION

Generator Name: Tronox LLCAddress: P.O. Box 55City: Henderson County: ClarkState: NV Zip: 89009Site Location (if different): 560 W. Lake MeadHenderson, NV 89015 (702) 592-7727

CUSTOMER/BILLING INFORMATION

Billing Name: NGE LLC c/o Northgate Environment ManagementAddress: 300 Frank Ogawa Plaza, Ste 510City: Oakland County: AlamedaState: CA Zip: 94612

Republic Services Approval #	Description of Waste	Volume/Weight	Expiration Date	Container Type
38251011244	Soil for disposal		12-31-2011	Tractor with Dump Trailer(s)
	RZ- # _____	31.01 TB		

*Attach Additional Sheet if necessary

I hereby certify that the above-described materials are non-hazardous wastes as defined by 40 CFR 261 or any applicable state law. Further, that the above named materials are properly classified, described, packaged, marked and labeled, and are in proper condition for transportation according to the applicable regulations of the Department of Transportation.

Susan Crowley *Susan Crowley* _____
 Generator/Authorized Agent Name Signature Date Shipped

TRANSPORTER INFORMATION

Transporter Name: Las Vegas PavingDOT # 191949Address: 4420 S. DecaturTruck Number: 125Las Vegas, NV 89103Phone Number: (702) 353-4355

I certify no hazardous waste or other regulated substance was knowingly introduced to the waste while in my custody. The waste transported in this vehicle is the waste identified above, to the best of my knowledge.

Calvin Paguio *Calvin Paguio* 10-05-10
 Name of Authorized Agent Signature Date Delivered

DISPOSAL SITE INFORMATION

Site Name: Apex Regional LandfillPhone No. (702) 599-5920Address: 13550 U.S. Hwy 93 Las Vegas, NV

I hereby acknowledge receipt of the above described materials
Jesse Smith *Jesse Smith* 10-2-10
 Name (Print or Type) Signature Date Received

81 Environmental Tech
13550 N Highway 93
Las Vegas, NV 89165

Ticket Type: INBOUND INVOICE

Ticket Number: 1883
Date: 10/07/2010
Time In: 12:28 am
Time Out: 12:53 am

Customer: 001011 - NGE, LLC c/o Northgate Environ Mgmt

Vehicle/Container: 82418P
Contract: Northgate Env. On Site Soils 3825 11
Comment: 3825 10 11244

Gross Weight: 130,060 LB Manual In
Tare Weight: 65,380 LB Manual Out
Net Weight: 64680 LB
Net Tons: 32.34

BOL: 11975

Origin	Yards	Material	Billing	Quantity
Not Applicable	0.00 YD	SW CONTAMINATED SOIL	32.34	TN

Driver: _____

Weighmaster: _____

SMITHJ

Indemnification. Customer agrees, by signature above, to indemnify, hold harmless, and defend Republic Services, Inc., its subsidiaries, affiliates, employees, officers and directors from and against any and all liabilities, claims, penalties, forfeitures, suits and the costs and expenses incident thereto, including costs of defense, settlement, and reasonable attorney's fees, which may be incurred, as a result of death or injuries to any person, or damage to any property, contamination of or adverse effects on the environment, caused in whole or in part by the Customer, its employees, or subcontractors in disposing waste at this Facility. In the event Customer delivers Unacceptable Waste (as determined by Republic) Customer agrees to assume all expenses and obligations with the removal and/or resolution of any effects caused by the delivery of such Unacceptable Waste.

Indemnización. Cliente acuerda indemnizar, mantener inmune, y defender Republic Services, Inc., sus subsidiarios, compañías, divisiones, empleados, oficiales y directores contra de cualquiera y de todas responsabilidades, demandas, penas, pérdidas, juicios, pleitos y los costos incidente además, incluyendo costos de defensa, de acuerdo judicial, y de honorarios razonables del abogado, que pueden ser incurridos en, o como resultado de, la muerte o herida personal a cualquier persona, o daños a cualquier característica, propiedad, contaminación de la tierra o efectos ilícitos en esta Facilidad, causado entero o en parte por el cliente, sus empleados, o sus subcontratistas en botar basura en esta Facilidad. En el caso que el Cliente entrega, bota, basura (según lo determinado por Republic) en este Establecimiento basura inaceptable en los reglamentos de este Establecimiento, el Cliente se compromete asumir todos los costos y obligaciones con el retiro y/o la resolución de cualquier dano(s) causado por la entrega de tal basura inaceptable.



NON-HAZARDOUS WASTE MANIFEST

MANIFEST # 11975

GENERATOR INFORMATION

Generator Name: Tronox LLC
Address: P.O. Box 55
City: Henderson County: Clark
State: NV Zip: 89009
Site Location (if different): 560 W. Lake Mead
Henderson, NV 89015 (702) 592-7727

CUSTOMER/BILLING INFORMATION

Billing Name: NGE LLC c/o Northgate Environment Management
Address: 300 Frank Ogawa Plaza, Ste 510
City: Oakland County: Alameda
State: CA Zip: 94612

Table with 5 columns: Republic Services Approval #, Description of Waste, Volume/Weight, Expiration Date, Container Type. Row 1: 38251011244, Soil for disposal, 32.38 TON, 12-31-2011, Tractor with Dump Trailer(s).

*Attach Additional Sheet if necessary

I hereby certify that the above-described materials are non-hazardous wastes as defined by 40 CFR 261 or any applicable state law. Further, that the above named materials are properly classified, described, packaged, marked and labeled, and are in proper condition for transportation according to the applicable regulations of the Department of Transportation.

Susan Crowley
Generator/Authorized Agent Name Signature Date Shipped

TRANSPORTER INFORMATION

Transporter Name: Las Vegas Paving DOT # 191949
Address: 4420 S. Decatur Truck Number: 220
Las Vegas, NV 89103 Phone Number: (702) 353-4355

I certify no hazardous waste or other regulated substance was knowingly introduced to the waste while in my custody. The waste transported in this vehicle is the waste identified above, to the best of my knowledge.

STEVE TAYLOR
Name of Authorized Agent Signature Date Delivered 10-6-10

DISPOSAL SITE INFORMATION

Site Name: Apex Regional Landfill Phone No. (702) 599-5920
Address: 13550 U.S. Hwy 93 Las Vegas, NV

I hereby acknowledge receipt of the above described materials
Name (Print or Type) Signature Date Received 10-7-10

81 Environmental Tech
13550 N Highway 93
Las Vegas, NV 89165

Ticket Type: INBOUND INVOICE

Ticket Number: 1884
Date: 10/07/2010
Time In: 12:36 am
Time Out: 12:58 am

Customer: 001011 - NGE, LLC c/o Northgate Environ Mgmt

Vehicle/Container: 86053P
Contract: Northgate Env. On Site Soils 3825 11
Comment: 3825 10 11244

Gross Weight: 121,680 LB Manual In
Tare Weight: 58,960 LB Manual Out
Net Weight: 62720 LB
Net Tons: 31.36

BOL: 11977

Origin	Yards	Material	Billing Quantity
Not Applicable	0.00 YD	SW CONTAMINATED SOIL	31.36 TN

Driver: _____

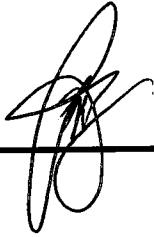

Weighmaster: _____

SMITHJ

Indemnification. Customer agrees, by signature above, to indemnify, hold harmless, and defend Republic Services, Inc., its subsidiaries, affiliates, employees, officers and directors from and against any and all liabilities, claims, penalties, forfeitures, suits and the costs and expenses incident thereto, including costs of defense, settlement, and reasonable attorney's fees, which may be incurred, as a result of death or injuries to any person, or damage to any property, contamination of or adverse effects on the environment, caused in whole or in part by the Customer, its employees, or subcontractors in disposing waste at this Facility. In the event Customer delivers Unacceptable Waste (as determined by Republic) Customer agrees to assume all expenses and obligations with the removal and/or resolution of any effects caused by the delivery of such Unacceptable Waste.

Indemnización. Cliente acuerda indemnizar, mantener inmune, y defender Republic Services, Inc., sus subsidiarios, compañías, divisiones, empleados, oficiales y directores contra de cualquiera y de todas responsabilidades, demandas, penas, pérdidas, juicios, pleitos y los costos incidente además, incluyendo costos de defensa, de acuerdo judicial, y de honorarios razonables del abogado, que pueden ser incurridos en, o como resultado de, la muerte o herida personal a cualquier persona, o daños a cualquier característica, propiedad, contaminación de la tierra o efectos ilícitos en esta Facilidad, causado entero o en parte por el cliente, sus empleados, o sus subcontratistas en botar basura en esta Facilidad. En el caso que el Cliente entrega, bota, basura (según lo determinado por Republic) en este Establecimiento basura inaceptable en los reglamentos de este Establecimiento, el Cliente se compromete asumir todos los costos y obligaciones con el retiro y/o la resolución de cualquier dano(s) causado por la entrega de tal basura inaceptable.



NON-HAZARDOUS WASTE MANIFEST

MANIFEST # 11977

GENERATOR INFORMATION

Generator Name: Tronox LLC

Address: P.O. Box 55

City: Henderson County: Clark

State: NV Zip: 89009

Site Location (if different): 560 W. Lake Mead

Henderson, NV 89015 (702) 592-7727

CUSTOMER/BILLING INFORMATION

Billing Name: NGE LLC c/o Northgate Environment Management

Address: 300 Frank Ogawa Plaza, Ste 510

City: Oakland County: Alameda

State: CA Zip: 94612

Republic Services Approval #	Description of Waste	Volume/Weight	Expiration Date	Container Type
38251011244	Soil for disposal		12-31-2011	Tractor with Dump Trailer(s)
	RZ- _____ # _____	31.26 TON		

*Attach Additional Sheet if necessary

I hereby certify that the above-described materials are non-hazardous wastes as defined by 40 CFR 261 or any applicable state law. Further, that the above named materials are properly classified, described, packaged, marked and labeled, and are in proper condition for transportation according to the applicable regulations of the Department of Transportation.

Susan Crowley Generator/Authorized Agent Name Signature Date Shipped

TRANSPORTER INFORMATION

Transporter Name: Las Vegas Paving

DOT # 191949

Address: 4420 S. Decatur

Truck Number: 261

Las Vegas, NV 89103

Phone Number: (702) 353-4355

I certify no hazardous waste or other regulated substance was knowingly introduced to the waste while in my custody. The waste transported in this vehicle is the waste identified above, to the best of my knowledge.

Name of Authorized Agent Signature Date Delivered

DISPOSAL SITE INFORMATION

Site Name: Apex Regional Landfill

Phone No. (702) 599-5920

Address: 13550 U.S. Hwy 93 Las Vegas, NV

I hereby acknowledge receipt of the above described materials

Name (Print or Type) Signature Date Received

81 Environmental Tech
13550 N Highway 93
Las Vegas, NV 89165

Ticket Type: INBOUND INVOICE

Ticket Number: 1885
Date: 10/07/2010
Time In: 12:37 am
Time Out: 12:59 am

Customer: 001011 - NGE, LLC c/o Northgate Environ Mgmt

Vehicle/Container: 76810P
Contract: Northgate Env. On Site Soils 3825 11
Comment: 3825 10 11244

Gross Weight: 117,660 LB Manual In
Tare Weight: 57,560 LB Manual Out
Net Weight: 60100 LB
Net Tons: 30.05

BOL: 11978

Origin	Yards	Material	Billing	Quantity
Not Applicable	0.00 YD	SW CONTAMINATED SOIL	30.05	TN

Driver:

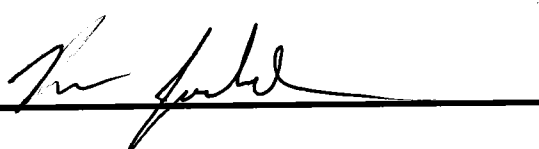

Weighmaster:

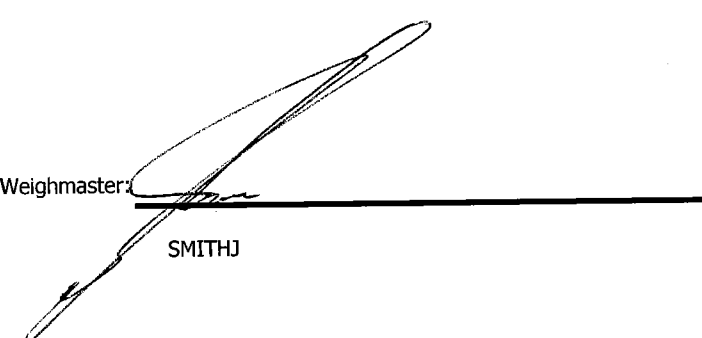

SMITHJ

Indemnification. Customer agrees, by signature above, to indemnify, hold harmless, and defend Republic Services, Inc., its subsidiaries, affiliates, employees, officers and directors from and against any and all liabilities, claims, penalties, forfeitures, suits and the costs and expenses incident thereto, including costs of defense, settlement, and reasonable attorney's fees, which may be incurred, as a result of death or injuries to any person, or damage to any property, contamination of or adverse effects on the environment, caused in whole or in part by the Customer, its employees, or subcontractors in disposing waste at this Facility. In the event Customer delivers Unacceptable Waste (as determined by Republic) Customer agrees to assume all expenses and obligations with the removal and/or resolution of any effects caused by the delivery of such Unacceptable Waste.

Indemnización. Cliente acuerda indemnizar, mantener inmune, y defender Republic Services, Inc., sus subsidiarios, compañías, divisiones, empleados, oficiales y directores contra de cualquiera y de todas responsabilidades, demandas, penas, pérdidas, juicios, pleitos y los costos incidente además, incluyendo costos de defensa, de acuerdo judicial, y de honorarios razonables del abogado, que pueden ser incurridos en, o como resultado de, la muerte o herida personal a cualquier persona, o daños a cualquier característica, propiedad, contaminación de la tierra o efectos ilícitos en esta Facilidad, causado entero o en parte por el cliente, sus empleados, o sus subcontratistas en botar basura en esta Facilidad. En el caso que el Cliente entrega, bota, basura (según lo determinado por Republic) en este Establecimiento basura inaceptable en los reglamentos de este Establecimiento, el Cliente se compromete asumir todos los costos y obligaciones con el retiro y/o la resolución de cualquier dano(s) causado por la entrega de tal basura inaceptable.



NON-HAZARDOUS WASTE MANIFEST

MANIFEST # 11978

GENERATOR INFORMATION

Generator Name: Tronox LLC

Address: P.O. Box 55

City: Henderson County: Clark

State: NV Zip: 89009

Site Location (if different): 560 W. Lake Mead

Henderson, NV 89015 (702) 592-7727

CUSTOMER/BILLING INFORMATION

Billing Name: NGE LLC c/o Northgate Environment Management

Address: 300 Frank Ogawa Plaza, Ste 510

City: Oakland County: Alameda

State: CA Zip: 94612

Table with 5 columns: Republic Services Approval #, Description of Waste, Volume/Weight, Expiration Date, Container Type. Row 1: 38251011244, Soil for disposal, 30.057M, 12-31-2011, Tractor with Dump Trailer(s). Row 2: RZ- #

*Attach Additional Sheet if necessary

I hereby certify that the above-described materials are non-hazardous wastes as defined by 40 CFR 261 or any applicable state law. Further, that the above named materials are properly classified, described, packaged, marked and labeled, and are in proper condition for transportation according to the applicable regulations of the Department of Transportation.

Susan Crowley (Signature) Generator/Authorized Agent Name Signature Date Shipped

TRANSPORTER INFORMATION

Transporter Name: Las Vegas Paving

DOT # 191949

Address: 4420 S. Decatur

Truck Number: 241

Las Vegas, NV 89103

Phone Number: (702) 353-4355

I certify no hazardous waste or other regulated substance was knowingly introduced to the waste while in my custody. The waste transported in this vehicle is the waste identified above, to the best of my knowledge.

Ken Jackson (Signature) Name of Authorized Agent Signature Date Delivered 10-6-2010

DISPOSAL SITE INFORMATION

Site Name: Apex Regional Landfill

Phone No. (702) 599-5920

Address: 13550 U.S. Hwy 93 Las Vegas, NV

I hereby acknowledge receipt of the above described materials

2501 SW 16 (Signature) Name (Print or Type) Signature Date Received 6-2-10

81 Environmental Tech
13550 N Highway 93
Las Vegas, NV 89165

Ticket Type: INBOUND INVOICE

Ticket Number: 1886
Date: 10/07/2010
Time In: 12:35 am
Time Out: 1:02 am

Customer: 001011 - NGE, LLC c/o Northgate Environ Mgmt

Vehicle/Container: 34330A

Contract: Northgate Env. On Site Soils 3825 11

Comment: 3825 10 11244

Gross Weight: 118,280 LB Manual In
Tare Weight: 53,540 LB Manual Out
Net Weight: 64,740 LB
Net Tons: 32.37

BOL: 11976

Origin	Yards	Material	Billing	Quantity
Not Applicable	0.00 YD	SW CONTAMINATED SOIL	32.37	TN

Driver:



Weighmaster:



SMITHJ

Indemnification. Customer agrees, by signature above, to indemnify, hold harmless, and defend Republic Services, Inc., its subsidiaries, affiliates, employees, officers and directors from and against any and all liabilities, claims, penalties, forfeitures, suits and the costs and expenses incident thereto, including costs of defense, settlement, and reasonable attorney's fees, which may be incurred, as a result of death or injuries to any person, or damage to any property, contamination of or adverse effects on the environment, caused in whole or in part by the Customer, its employees, or subcontractors in disposing waste at this Facility. In the event Customer delivers Unacceptable Waste (as determined by Republic) Customer agrees to assume all expenses and obligations with the removal and/or resolution of any effects caused by the delivery of such Unacceptable Waste.

Indemnización. Cliente acuerda indemnizar, mantener inmune, y defender Republic Services, Inc., sus subsidiarios, compañías, divisiones, empleados, oficiales y directores contra de cualquiera y de todas responsabilidades, demandas, penas, pérdidas, juicios, pleitos y los costos incidente además, incluyendo costos de defensa, de acuerdo judicial, y de honorarios razonables del abogado, que pueden ser incurridos en, o como resultado de, la muerte o herida personal a cualquier persona, o daños a cualquier característica, propiedad, contaminación de la tierra o efectos ilícitos en esta Facilidad, causado entero o en parte por el cliente, sus empleados, o sus subcontratistas en botar basura en esta Facilidad. En el caso que el Cliente entrega, bota, basura (según lo determinado por Republic) en este Establecimiento basura inaceptable en los reglamentos de este Establecimiento, el Cliente se compromete asumir todos los costos y obligaciones con el retiro y/o la resolución de cualquier dano(s) causado por la entrega de tal basura inaceptable.



NON-HAZARDOUS WASTE MANIFEST

MANIFEST # 11976

GENERATOR INFORMATION

Generator Name: Tronox LLC
Address: P.O. Box 55
City: Henderson County: Clark
State: NV Zip: 89009
Site Location (if different): 560 W. Lake Mead
Henderson, NV 89015 (702) 592-7727

CUSTOMER/BILLING INFORMATION

Billing Name: NGE LLC c/o Northgate Environment Management
Address: 300 Frank Ogawa Plaza, Ste 510
City: Oakland County: Alameda
State: CA Zip: 94612

Table with 5 columns: Republic Services Approval #, Description of Waste, Volume/Weight, Expiration Date, Container Type. Row 1: 38251011244, Soil for disposal, 32.27 m, 12-31-2011, Tractor with Dump Trailer(s).

*Attach Additional Sheet if necessary

I hereby certify that the above-described materials are non-hazardous wastes as defined by 40 CFR 261 or any applicable state law. Further, that the above named materials are properly classified, described, packaged, marked and labeled, and are in proper condition for transportation according to the applicable regulations of the Department of Transportation.

Susan Crowley (Signature)
Generator/Authorized Agent Name Signature Date Shipped

TRANSPORTER INFORMATION

Transporter Name: Las Vegas Paving DOT # 191949
Address: 4420 S. Decatur Truck Number: 981
Las Vegas, NV 89103 Phone Number: (702) 353-4355

I certify no hazardous waste or other regulated substance was knowingly introduced to the waste while in my custody. The waste transported in this vehicle is the waste identified above, to the best of my knowledge.

Tom Crowley (Signature) Thomas Rave (Signature) 10-6-10
Name of Authorized Agent Signature Date Delivered

DISPOSAL SITE INFORMATION

Site Name: Apex Regional Landfill Phone No. (702) 599-5920
Address: 13550 U.S. Hwy 93 Las Vegas, NV

I hereby acknowledge receipt of the above described materials
Name (Print or Type) Signature Date Received

81 Environmental Tech
13550 N Highway 93
Las Vegas, NV 89165

Ticket Type: INBOUND INVOICE

Ticket Number: 1887
Date: 10/07/2010
Time In: 12:46 am
Time Out: 1:10 am

Customer: 001011 - NGE, LLC c/o Northgate Environ Mgmt

Vehicle/Container: 76811P
Contract: Northgate Env. On Site Soils 3825 11
Comment: 3825 10 11244

Gross Weight: 119,300 LB Manual In
Tare Weight: 53,920 LB Manual Out
Net Weight: 65380 LB
Net Tons: 32.69

BOL: 11979

Origin	Yards	Material	Billing	Quantity
Not Applicable	0.00 YD	SW CONTAMINATED SOIL	32.69	TN

Driver:

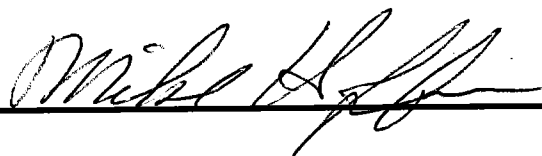

Weighmaster:

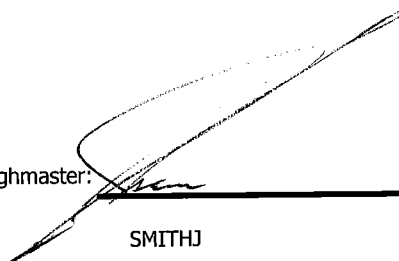

SMITHJ

Indemnification. Customer agrees, by signature above, to indemnify, hold harmless, and defend Republic Services, Inc., its subsidiaries, affiliates, employees, officers and directors from and against any and all liabilities, claims, penalties, forfeitures, suits and the costs and expenses incident thereto, including costs of defense, settlement, and reasonable attorney's fees, which may be incurred, as a result of death or injuries to any person, or damage to any property, contamination of or adverse effects on the environment, caused in whole or in part by the Customer, its employees, or subcontractors in disposing waste at this Facility. In the event Customer delivers Unacceptable Waste (as determined by Republic) Customer agrees to assume all expenses and obligations with the removal and/or resolution of any effects caused by the delivery of such Unacceptable Waste.

Indemnización. Cliente acuerda indemnizar, mantener inmune, y defender Republic Services, Inc., sus subsidiarios, compañías, divisiones, empleados, oficiales y directores contra de cualquiera y de todas responsabilidades, demandas, penas, pérdidas, juicios, pleitos y los costos incidente además, incluyendo costos de defensa, de acuerdo judicial, y de honorarios razonables del abogado, que pueden ser incurridos en, o como resultado de, la muerte o herida personal a cualquier persona, o daños a cualquier característica, propiedad, contaminación de la tierra o efectos ilícitos en esta Facilidad. En el caso que el Cliente entrega, bota, basura (según lo determinado por Republic) en este Establecimiento basura inaceptable en los reglamentos de este Establecimiento, el Cliente se compromete asumir todos los costos y obligaciones con el retiro y/o la resolución de cualquier dano(s) causado por la entrega de tal basura inaceptable.



NON-HAZARDOUS WASTE MANIFEST

MANIFEST # 11979

GENERATOR INFORMATION

Generator Name: Tronox LLC

Address: P.O. Box 55

City: Henderson County: Clark

State: NV Zip: 89009

Site Location (if different): 560 W. Lake Mead
Henderson, NV 89015 (702) 592-7727

CUSTOMER/BILLING INFORMATION

Billing Name: NGE LLC c/o Northgate Environment Management

Address: 300 Frank Ogawa Plaza, Ste 510

City: Oakland County: Alameda

State: CA Zip: 94612

Republic Services Approval #	Description of Waste	Volume/Weight	Expiration Date	Container Type
38251011244	Soil for disposal		12-31-2011	Tractor with Dump Trailer(s)
	RZ-_____#_____	32.69 TON		

*Attach Additional Sheet if necessary

I hereby certify that the above-described materials are non-hazardous wastes as defined by 40 CFR 261 or any applicable state law. Further, that the above named materials are properly classified, described, packaged, marked and labeled, and are in proper condition for transportation according to the applicable regulations of the Department of Transportation.

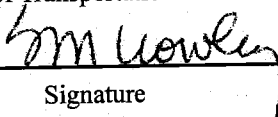
Susan Crowley  _____
 Generator/Authorized Agent Name Signature Date Shipped

TRANSPORTER INFORMATION

Transporter Name: Las Vegas Paving

DOT # 191949

Address: 4420 S. Decatur

Truck Number: 272

Las Vegas, NV 89103

Phone Number: (702) 353-4355

I certify no hazardous waste or other regulated substance was knowingly introduced to the waste while in my custody. The waste transported in this vehicle is the waste identified above, to the best of my knowledge.

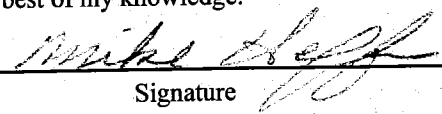
Mike Heffer  _____ 10-6-10
 Name of Authorized Agent Signature Date Delivered

DISPOSAL SITE INFORMATION

Site Name: Apex Regional Landfill

Phone No. (702) 599-5920

Address: 13550 U.S. Hwy 93 Las Vegas, NV

I hereby acknowledge receipt of the above described materials

Eric Smith _____ 10-7-10
 Name (Print or Type) Signature Date Received

81 Environmental Tech
13550 N Highway 93
Las Vegas, NV 89165

Ticket Type: INBOUND INVOICE

Ticket Number: 1888
Date: 10/07/2010
Time In: 12:53 am
Time Out: 1:16 am

Customer: 001011 - NGE, LLC c/o Northgate Environ Mgmt

Vehicle/Container: 68263P
Contract: Northgate Env. On Site Soils 3825 11
Comment: 3825 10 11244

Gross Weight: 117,820 LB Manual In
Tare Weight: 54,700 LB Manual Out
Net Weight: 63120 LB
Net Tons: 31.56

BOL: 11980

Origin	Yards	Material	Billing	Quantity
Not Applicable	0.00 YD	SW CONTAMINATED SOIL	31.56	TN

Driver: _____

Weighmaster: _____

SMITHJ

Indemnification. Customer agrees, by signature above, to indemnify, hold harmless, and defend Republic Services, Inc., its subsidiaries, affiliates, employees, officers and directors from and against any and all liabilities, claims, penalties, forfeitures, suits and the costs and expenses incident thereto, including costs of defense, settlement, and reasonable attorney's fees, which may be incurred, as a result of death or injuries to any person, or damage to any property, contamination of or adverse effects on the environment, caused in whole or in part by the Customer, its employees, or subcontractors in disposing waste at this Facility. In the event Customer delivers Unacceptable Waste (as determined by Republic) Customer agrees to assume all expenses and obligations with the removal and/or resolution of any effects caused by the delivery of such Unacceptable Waste.

Indemnización. Cliente acuerda indemnizar, mantener inmune, y defender Republic Services, Inc., sus subsidiarios, compañías, divisiones, empleados, oficiales y directores contra de cualquiera y de todas responsabilidades, demandas, penas, pérdidas, juicios, pleitos y los costos incidente además, incluyendo costos de defensa, de acuerdo judicial, y de honorarios razonables del abogado, que pueden ser incurridos en, o como resultado de, la muerte o herida personal a cualquier persona, o daños a cualquier característica, propiedad, contaminación de la tierra o efectos ilícitos en esta Facilidad, causado entero o en parte por el cliente, sus empleados, o sus subcontratistas en botar basura en esta Facilidad. En el caso que el Cliente entrega, bota, basura (según lo determinado por Republic) en este Establecimiento basura inaceptable en los reglamentos de este Establecimiento, el Cliente se compromete asumir todos los costos y obligaciones con el retiro y/o la resolución de cualquier dano(s) causado por la entrega de tal basura inaceptable.



NON-HAZARDOUS WASTE MANIFEST

MANIFEST # 11980

GENERATOR INFORMATION

Generator Name: Tronox LLC

Address: P.O. Box 55

City: Henderson County: Clark

State: NV Zip: 89009

Site Location (if different): 560 W. Lake Mead
Henderson, NV 89015 (702) 592-7727

CUSTOMER/BILLING INFORMATION

Billing Name: NGE LLC c/o Northgate Environment Management

Address: 300 Frank Ogawa Plaza, Ste 510

City: Oakland County: Alameda

State: CA Zip: 94612

Table with 5 columns: Republic Services Approval #, Description of Waste, Volume/Weight, Expiration Date, Container Type. Row 1: 38251011244, Soil for disposal, 31.56 TW, 12-31-2011, Tractor with Dump Trailer(s).

*Attach Additional Sheet if necessary

I hereby certify that the above-described materials are non-hazardous wastes as defined by 40 CFR 261 or any applicable state law. Further, that the above named materials are properly classified, described, packaged, marked and labeled, and are in proper condition for transportation according to the applicable regulations of the Department of Transportation.

Susan Crowley (Signature)
Generator/Authorized Agent Name Signature Date Shipped

TRANSPORTER INFORMATION

Transporter Name: Las Vegas Paving

DOT # 191949

Address: 4420 S. Decatur

Truck Number: 2711

Las Vegas, NV 89103

Phone Number: (702) 353-4355

I certify no hazardous waste or other regulated substance was knowingly introduced to the waste while in my custody. The waste transported in this vehicle is the waste identified above, to the best of my knowledge.

STEVE HAYES (Signature)
Name of Authorized Agent Signature Date Delivered 10-6-10

DISPOSAL SITE INFORMATION

Site Name: Apex Regional Landfill

Phone No. (702) 599-5920

Address: 13550 U.S. Hwy 93 Las Vegas, NV

I hereby acknowledge receipt of the above described materials
Name (Print or Type) Signature Date Received 10-7-10

81 Environmental Tech
13550 N Highway 93
Las Vegas, NV 89165

Ticket Type: INBOUND INVOICE

Ticket Number: 1889
Date: 10/07/2010
Time In: 12:58 am
Time Out: 1:18 am

Customer: 001011 - NGE, LLC c/o Northgate Environ Mgmt

Vehicle/Container: 44165A
Contract: Northgate Env. On Site Soils 3825 11
Comment: 3825 10 11244

Gross Weight: 127,320 LB Manual In
Tare Weight: 48,940 LB Manual Out
Net Weight: 78380 LB
Net Tons: 39.19

BOL: 11981

Origin	Yards	Material	Billing	Quantity
Not Applicable	0.00 YD	SW CONTAMINATED SOIL	39.19	TN

Driver: _____



Weighmaster: _____

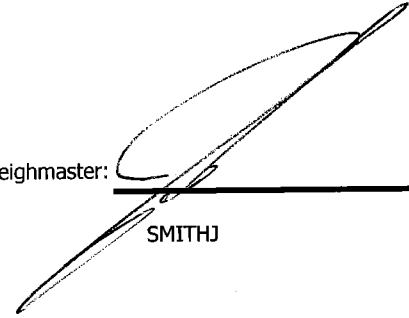

SMITHJ

Indemnification. Customer agrees, by signature above, to indemnify, hold harmless, and defend Republic Services, Inc., its subsidiaries, affiliates, employees, officers and directors from and against any and all liabilities, claims, penalties, forfeitures, suits and the costs and expenses incident thereto, including costs of defense, settlement, and reasonable attorney's fees, which may be incurred, as a result of death or injuries to any person, or damage to any property, contamination of or adverse effects on the environment, caused in whole or in part by the Customer, its employees, or subcontractors in disposing waste at this Facility. In the event Customer delivers Unacceptable Waste (as determined by Republic) Customer agrees to assume all expenses and obligations with the removal and/or resolution of any effects caused by the delivery of such Unacceptable Waste.

Indemnización. Cliente acuerda indemnizar, mantener inmune, y defender Republic Services, Inc., sus subsidiarios, compañías, divisiones, empleados, oficiales y directores contra de cualquiera y de todas responsabilidades, demandas, penas, pérdidas, juicios, pleitos y los costos incidente además, incluyendo costos de defensa, de acuerdo judicial, y de honorarios razonables del abogado, que pueden ser incurridos en, o como resultado de, la muerte o herida personal a cualquier persona, o daños a cualquier característica, propiedad, contaminación de la tierra o efectos ilícitos en esta Facilidad, causado entero o en parte por el cliente, sus empleados, o sus subcontratistas en botar basura en esta Facilidad. En el caso que el Cliente entrega, bota, basura (según lo determinado por Republic) en este Establecimiento basura inaceptable en los reglamentos de este Establecimiento, el Cliente se compromete asumir todos los costos y obligaciones con el retiro y/o la resolución de cualquier dano(s) causado por la entrega de tal basura inaceptable.



NON-HAZARDOUS WASTE MANIFEST

MANIFEST # 11981

GENERATOR INFORMATION

Generator Name: Tronox LLC
Address: P.O. Box 55
City: Henderson County: Clark
State: NV Zip: 89009
Site Location (if different): 560 W. Lake Mead
Henderson, NV 89015 (702) 592-7727

CUSTOMER/BILLING INFORMATION

Billing Name: NGE LLC c/o Northgate Environment Management
Address: 300 Frank Ogawa Plaza, Ste 510
City: Oakland County: Alameda
State: CA Zip: 94612

Table with 5 columns: Republic Services Approval #, Description of Waste, Volume/Weight, Expiration Date, Container Type. Row 1: 38251011244, Soil for disposal, 39.19 cu, 12-31-2011, Tractor with Dump Trailer(s).

*Attach Additional Sheet if necessary

I hereby certify that the above-described materials are non-hazardous wastes as defined by 40 CFR 261 or any applicable state law. Further, that the above named materials are properly classified, described, packaged, marked and labeled, and are in proper condition for transportation according to the applicable regulations of the Department of Transportation.

Susan Crowley
Generator/Authorized Agent Name Signature Date Shipped

TRANSPORTER INFORMATION

Transporter Name: Las Vegas Paving DOT # 191949
Address: 4420 S. Decatur Truck Number: 4001
Las Vegas, NV 89103 Phone Number: (702) 353-4355

I certify no hazardous waste or other regulated substance was knowingly introduced to the waste while in my custody. The waste transported in this vehicle is the waste identified above, to the best of my knowledge.

CEBU Signature Date Delivered 10/20/10
Name of Authorized Agent Signature Date Delivered

DISPOSAL SITE INFORMATION

Site Name: Apex Regional Landfill Phone No. (702) 599-5920
Address: 13550 U.S. Hwy 93 Las Vegas, NV

I hereby acknowledge receipt of the above described materials
Name (Print or Type) Signature Date Received 10-7-10

81 Environmental Tech
13550 N Highway 93
Las Vegas, NV 89165

Ticket Type: INBOUND INVOICE

Ticket Number: 1890
Date: 10/07/2010
Time In: 1:07 am
Time Out: 1:39 am

Customer: 001011 - NGE, LLC c/o Northgate Environ Mgmt

Vehicle/Container: 43073A
Contract: Northgate Env. On Site Soils 3825 11
Comment: 3825 10 11244

Gross Weight: 120,220 LB Manual In
Tare Weight: 55,860 LB Manual Out
Net Weight: 64360 LB
Net Tons: 32.18

BOL: 11982

Origin	Yards	Material	Billing	Quantity
Not Applicable	0.00 YD	SW CONTAMINATED SOIL	32.18	TN

Driver: _____

Weighmaster: _____

SMITHJ

Indemnification. Customer agrees, by signature above, to indemnify, hold harmless, and defend Republic Services, Inc., its subsidiaries, affiliates, employees, officers and directors from and against any and all liabilities, claims, penalties, forfeitures, suits and the costs and expenses incident thereto, including costs of defense, settlement, and reasonable attorney's fees, which may be incurred, as a result of death or injuries to any person, or damage to any property, contamination of or adverse effects on the environment, caused in whole or in part by the Customer, its employees, or subcontractors in disposing waste at this Facility. In the event Customer delivers Unacceptable Waste (as determined by Republic) Customer agrees to assume all expenses and obligations with the removal and/or resolution of any effects caused by the delivery of such Unacceptable Waste.

Indemnización. Cliente acuerda indemnizar, mantener inmune, y defender Republic Services, Inc., sus subsidiarios, compañías, divisiones, empleados, oficiales y directores contra de cualquiera y de todas responsabilidades, demandas, penas, pérdidas, juicios, pleitos y los costos incidente además, incluyendo costos de defensa, de acuerdo judicial, y de honorarios razonables del abogado, que pueden ser incurridos en, o como resultado de, la muerte o herida personal a cualquier persona, o daños a cualquier característica, propiedad, contaminación de la tierra o efectos ilícitos en esta Facilidad, causado entero o en parte por el cliente, sus empleados, o sus subcontratistas en botar basura en esta Facilidad. En el caso que el Cliente entrega, bota, basura (según lo determinado por Republic) en este Establecimiento basura inaceptable en los reglamentos de este Establecimiento, el Cliente se compromete asumir todos los costos y obligaciones con el retiro y/o la resolución de cualquier dano(s) causado por la entrega de tal basura inaceptable.



NON-HAZARDOUS WASTE MANIFEST

MANIFEST # 11982

GENERATOR INFORMATION

Generator Name: Tronox LLC

Address: P.O. Box 55

City: Henderson County: Clark

State: NV Zip: 89009

Site Location (if different): 560 W. Lake Mead

Henderson, NV 89015 (702) 592-7727

CUSTOMER/BILLING INFORMATION

Billing Name: NGE LLC c/o Northgate Environment Management

Address: 300 Frank Ogawa Plaza, Ste 510

City: Oakland County: Alameda

State: CA Zip: 94612

Republic Services Approval #	Description of Waste	Volume/Weight	Expiration Date	Container Type
38251011244	Soil for disposal		12-31-2011	Tractor with Dump Trailer(s)
	RZ- #	32.18 TN		

*Attach Additional Sheet if necessary

I hereby certify that the above-described materials are non-hazardous wastes as defined by 40 CFR 261 or any applicable state law. Further, that the above named materials are properly classified, described, packaged, marked and labeled, and are in proper condition for transportation according to the applicable regulations of the Department of Transportation.

Susan Crowley Generator/Authorized Agent Name Signature Date Shipped

TRANSPORTER INFORMATION

Transporter Name: Las Vegas Paving

DOT # 191949

Address: 4420 S. Decatur

Truck Number: 89

Las Vegas, NV 89103

Phone Number: (702) 353-4355

I certify no hazardous waste or other regulated substance was knowingly introduced to the waste while in my custody. The waste transported in this vehicle is the waste identified above, to the best of my knowledge.

Name of Authorized Agent Signature Date Delivered

DISPOSAL SITE INFORMATION

Site Name: Apex Regional Landfill

Phone No. (702) 599-5920

Address: 13550 U.S. Hwy 93 Las Vegas, NV

I hereby acknowledge receipt of the above described materials

Name (Print or Type) Signature Date Received

81 Environmental Tech
13550 N Highway 93
Las Vegas, NV 89165

Ticket Type: INBOUND INVOICE

Ticket Number: 1891
Date: 10/07/2010
Time In: 1:19 am
Time Out: 1:45 am

Customer: 001011 - NGE, LLC c/o Northgate Environ Mgmt

Vehicle/Container: 44564A
Contract: Northgate Env. On Site Soils 3825 11
Comment: 3825 10 11244

Gross Weight: 131,620 LB Manual In
Tare Weight: 49,220 LB Manual Out
Net Weight: 82400 LB
Net Tons: 41.20

BOL: 11983

Origin	Yards	Material	Billing	Quantity
Not Applicable	0.00 YD	SW CONTAMINATED SOIL	41.20	TN

Driver: _____



Weighmaster: _____

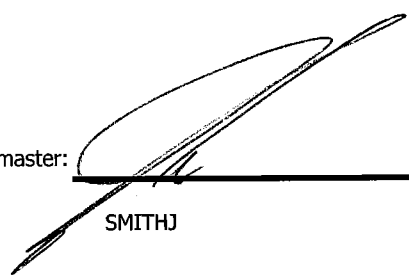

SMITHJ

Indemnification. Customer agrees, by signature above, to indemnify, hold harmless, and defend Republic Services, Inc., its subsidiaries, affiliates, employees, officers and directors from and against any and all liabilities, claims, penalties, forfeitures, suits and the costs and expenses incident thereto, including costs of defense, settlement, and reasonable attorney's fees, which may be incurred, as a result of death or injuries to any person, or damage to any property, contamination of or adverse effects on the environment, caused in whole or in part by the Customer, its employees, or subcontractors in disposing waste at this Facility. In the event Customer delivers Unacceptable Waste (as determined by Republic) Customer agrees to assume all expenses and obligations with the removal and/or resolution of any effects caused by the delivery of such Unacceptable Waste.

Indemnización. Cliente acuerda indemnizar, mantener inmune, y defender Republic Services, Inc., sus subsidiarios, compañías, divisiones, empleados, oficiales y directores contra de cualquiera y de todas responsabilidades, demandas, penas, pérdidas, juicios, pleitos y los costos incidente además, incluyendo costos de defensa, de acuerdo judicial, y de honorarios razonables del abogado, que pueden ser incurridos en, o como resultado de, la muerte o herida personal a cualquier persona, o daños a cualquier característica, propiedad, contaminación de la tierra o efectos ilícitos en esta Facilidad, causado entero o en parte por el cliente, sus empleados, o sus subcontratistas en botar basura en esta Facilidad. En el caso que el Cliente entrega, bota, basura (según lo determinado por Republic) en este Establecimiento basura inaceptable en los reglamentos de este Establecimiento, el Cliente se compromete asumir todos los costos y obligaciones con el retiro y/o la resolución de cualquier dano(s) causado por la entrega de tal basura inaceptable.



NON-HAZARDOUS WASTE MANIFEST

MANIFEST # 11983

GENERATOR INFORMATION

Generator Name: Tronox LLC

Address: P.O. Box 55

City: Henderson County: Clark

State: NV Zip: 89009

Site Location (if different): 560 W. Lake Mead

Henderson, NV 89015 (702) 592-7727

CUSTOMER/BILLING INFORMATION

Billing Name: NGE LLC c/o Northgate Environment Management

Address: 300 Frank Ogawa Plaza, Ste 510

City: Oakland County: Alameda

State: CA Zip: 94612

Republic Services Approval #	Description of Waste	Volume/Weight	Expiration Date	Container Type
38251011244	Soil for disposal		12-31-2011	Tractor with Dump Trailer(s)
	RZ- _____ # _____	41.20 TON		

*Attach Additional Sheet if necessary

I hereby certify that the above-described materials are non-hazardous wastes as defined by 40 CFR 261 or any applicable state law. Further, that the above named materials are properly classified, described, packaged, marked and labeled, and are in proper condition for transportation according to the applicable regulations of the Department of Transportation.

Susan Crowley

Susan Crowley

Generator/Authorized Agent Name

Signature

Date Shipped

TRANSPORTER INFORMATION

Transporter Name: Las Vegas Paving

DOT # 191949

Address: 4420 S. Decatur

Truck Number: 1003

Las Vegas, NV 89103

Phone Number: (702) 353-4355

I certify no hazardous waste or other regulated substance was knowingly introduced to the waste while in my custody. The waste transported in this vehicle is the waste identified above, to the best of my knowledge.

Ascencion

Ascencion

Name of Authorized Agent

Signature

Date Delivered

10/02/10

DISPOSAL SITE INFORMATION

Site Name: Apex Regional Landfill

Phone No. (702) 599-5920

Address: 13550 U.S. Hwy 93 Las Vegas, NV

I hereby acknowledge receipt of the above described materials.

Name (Print or Type)

Signature

Date Received

10/20

81 Environmental Tech
13550 N Highway 93
Las Vegas, NV 89165

Ticket Type: INBOUND INVOICE

Ticket Number: 1892
Date: 10/07/2010
Time In: 1:36 am
Time Out: 1:59 am

Customer: 001011 - NGE, LLC c/o Northgate Environ Mgmt

Vehicle/Container: 86113P
Contract: Northgate Env. On Site Soils 3825 11
Comment: 3825 10 11244

Gross Weight: 134,320 LB Manual In
Tare Weight: 55,340 LB Manual Out
Net Weight: 78980 LB
Net Tons: 39.49

BOL: 11984

Origin	Yards	Material	Billing	Quantity
Not Applicable	0.00 YD	SW CONTAMINATED SOIL	39.49	TN

Driver:

J. A. H.

Weighmaster:

SMITHJ

Indemnification. Customer agrees, by signature above, to indemnify, hold harmless, and defend Republic Services, Inc., its subsidiaries, affiliates, employees, officers and directors from and against any and all liabilities, claims, penalties, forfeitures, suits and the costs and expenses incident thereto, including costs of defense, settlement, and reasonable attorney's fees, which may be incurred, as a result of death or injuries to any person, or damage to any property, contamination of or adverse effects on the environment, caused in whole or in part by the Customer, its employees, or subcontractors in disposing waste at this Facility. In the event Customer delivers Unacceptable Waste (as determined by Republic) Customer agrees to assume all expenses and obligations with the removal and/or resolution of any effects caused by the delivery of such Unacceptable Waste.

Indemnización. Cliente acuerda indemnizar, mantener inmune, y defender Republic Services, Inc., sus subsidiarios, compañías, divisiones, empleados, oficiales y directores contra de cualquiera y de todas responsabilidades, demandas, penas, pérdidas, juicios, pleitos y los costos incidente además, incluyendo costos de defensa, de acuerdo judicial, y de honorarios razonables del abogado, que pueden ser incurridos en, o como resultado de, la muerte o herida personal a cualquier persona, o daños a cualquier característica, propiedad, contaminación de la tierra o efectos ilícitos en esta Facilidad, causado entero o en parte por el cliente, sus empleados, o sus subcontratistas en botar basura en esta Facilidad. En el caso que el Cliente entrega, bota, basura (según lo determinado por Republic) en este Establecimiento basura inaceptable en los reglamentos de este Establecimiento, el Cliente se compromete asumir todos los costos y obligaciones con el retiro y/o la resolución de cualquier dano(s) causado por la entrega de tal basura inaceptable.



NON-HAZARDOUS WASTE MANIFEST

MANIFEST # 11984

GENERATOR INFORMATION

Generator Name: Tronox LLC

Address: P.O. Box 55

City: Henderson County: Clark

State: NV Zip: 89009

Site Location (if different): 560 W. Lake Mead

Henderson, NV 89015 (702) 592-7727

CUSTOMER/BILLING INFORMATION

Billing Name: NGE LLC c/o Northgate Environment Management

Address: 300 Frank Ogawa Plaza, Ste 510

City: Oakland County: Alameda

State: CA Zip: 94612

Republic Services Approval #	Description of Waste	Volume/Weight	Expiration Date	Container Type
38251011244	Soil for disposal		12-31-2011	Tractor with Dump Trailer(s)
	RZ- _____ # _____	37.49 Td		

*Attach Additional Sheet if necessary

I hereby certify that the above-described materials are non-hazardous wastes as defined by 40 CFR 261 or any applicable state law. Further, that the above named materials are properly classified, described, packaged, marked and labeled, and are in proper condition for transportation according to the applicable regulations of the Department of Transportation.

Susan Crowley (Signature) Date Shipped

TRANSPORTER INFORMATION

Transporter Name: Las Vegas Paving

DOT # 191949

Address: 4420 S. Decatur

Truck Number: K0019/7

Las Vegas, NV 89103

Phone Number: (702) 353-4355

I certify no hazardous waste or other regulated substance was knowingly introduced to the waste while in my custody. The waste transported in this vehicle is the waste identified above, to the best of my knowledge.

ALBERTO (Signature) Date Delivered: Oct 6, 2010

DISPOSAL SITE INFORMATION

Site Name: Apex Regional Landfill

Phone No. (702) 599-5920

Address: 13550 U.S. Hwy 93 Las Vegas, NV

I hereby acknowledge receipt of the above described materials

JC... (Signature) Date Received

81 Environmental Tech
13550 N Highway 93
Las Vegas, NV 89165

Ticket Type: INBOUND INVOICE

Ticket Number: 1893
Date: 10/07/2010
Time In: ~~2:20 am~~ 1:53
Time Out: 2:20 am

Customer: 001011 - NGE, LLC c/o Northgate Environ Mgmt

Vehicle/Container: 85887P
Contract: Northgate Env. On Site Soils 3825 11
Comment: 3825 10 11244

Gross Weight: 133,760 LB Manual In
Tare Weight: 51,060 LB Manual Out
Net Weight: 82700 LB
Net Tons: 41.35

BOL: 11985

Origin	Yards	Material	Billing	Quantity
Not Applicable	0.00 YD	SW CONTAMINATED SOIL	41.35	TN

Driver:

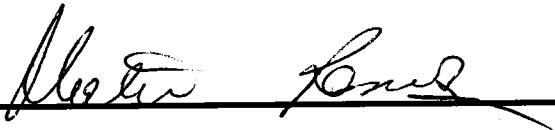

Weighmaster:

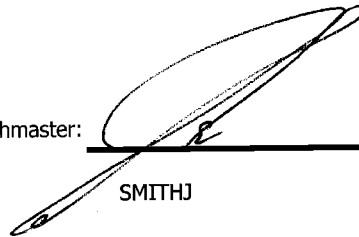

SMITHJ

Indemnification. Customer agrees, by signature above, to indemnify, hold harmless, and defend Republic Services, Inc., its subsidiaries, affiliates, employees, officers and directors from and against any and all liabilities, claims, penalties, forfeitures, suits and the costs and expenses incident thereto, including costs of defense, settlement, and reasonable attorney's fees, which may be incurred, as a result of death or injuries to any person, or damage to any property, contamination of or adverse effects on the environment, caused in whole or in part by the Customer, its employees, or subcontractors in disposing waste at this Facility. In the event Customer delivers Unacceptable Waste (as determined by Republic) Customer agrees to assume all expenses and obligations with the removal and/or resolution of any effects caused by the delivery of such Unacceptable Waste.

Indemnización. Cliente acuerda indemnizar, mantener inmune, y defender Republic Services, Inc., sus subsidiarios, compañías, divisiones, empleados, oficiales y directores contra de cualquiera y de todas responsabilidades, demandas, penas, pérdidas, juicios, pleitos y los costos incidente además, incluyendo costos de defensa, de acuerdo judicial, y de honorarios razonables del abogado, que pueden ser incurridos en, o como resultado de, la muerte o herida personal a cualquier persona, o daños a cualquier característica, propiedad, contaminación de la tierra o efectos ilícitos en esta Facilidad, causado entero o en parte por el cliente, sus empleados, o sus subcontratistas en botar basura en esta Facilidad. En el caso que el Cliente entrega, bota, basura (según lo determinado por Republic) en este Establecimiento basura inaceptable en los reglamentos de este Establecimiento, el Cliente se compromete asumir todos los costos y obligaciones con el retiro y/o la resolución de cualquier dano(s) causado por la entrega de tal basura inaceptable.



NON-HAZARDOUS WASTE MANIFEST

MANIFEST # 11985

GENERATOR INFORMATION

Generator Name: Tronox LLC
Address: P.O. Box 55
City: Henderson County: Clark
State: NV Zip: 89009
Site Location (if different): 560 W. Lake Mead
Henderson, NV 89015 (702) 592-7727

CUSTOMER/BILLING INFORMATION

Billing Name: NGE LLC c/o Northgate Environment Management
Address: 300 Frank Ogawa Plaza, Ste 510
City: Oakland County: Alameda
State: CA Zip: 94612

Table with 5 columns: Republic Services Approval #, Description of Waste, Volume/Weight, Expiration Date, Container Type. Row 1: 38251011244, Soil for disposal, 41.35 TON, 12-31-2011, Tractor with Dump Trailer(s).

*Attach Additional Sheet if necessary

I hereby certify that the above-described materials are non-hazardous wastes as defined by 40 CFR 261 or any applicable state law. Further, that the above named materials are properly classified, described, packaged, marked and labeled, and are in proper condition for transportation according to the applicable regulations of the Department of Transportation.

Susan Crowley (Generator/Authorized Agent Name), Tom Crowley (Signature), Date Shipped

TRANSPORTER INFORMATION

Transporter Name: Las Vegas Paving DOT # 191949
Address: 4420 S. Decatur Truck Number: R01
Las Vegas, NV 89103 Phone Number: (702) 353-4355

I certify no hazardous waste or other regulated substance was knowingly introduced to the waste while in my custody. The waste transported in this vehicle is the waste identified above, to the best of my knowledge.

Name of Authorized Agent, Signature, Date Delivered (10/6/10)

DISPOSAL SITE INFORMATION

Site Name: Apex Regional Landfill Phone No. (702) 599-5920
Address: 13550 U.S. Hwy 93 Las Vegas, NV

I hereby acknowledge receipt of the above described materials
Name (Print or Type), Signature, Date Received (10-7-10)

81 Environmental Tech
13550 N Highway 93
Las Vegas, NV 89165

Ticket Type: INBOUND INVOICE

Ticket Number: 1894
Date: 10/07/2010
Time In: 1:56 am
Time Out: 2:24 am

Customer: 001011 - NGE, LLC c/o Northgate Environ Mgmt

Vehicle/Container: 192457
Contract: Northgate Env. On Site Soils 3825 11
Comment: 3825 10 11244

Gross Weight: 130,120 LB Manual In
Tare Weight: 52,740 LB Manual Out
Net Weight: 77380 LB
Net Tons: 38.69

BOL: 11986

Origin	Yards	Material	Billing	Quantity
Not Applicable	0.00 YD	SW CONTAMINATED SOIL	38.69	TN

Driver: 

Weighmaster: _____

SMITHJ

Indemnification. Customer agrees, by signature above, to indemnify, hold harmless, and defend Republic Services, Inc., its subsidiaries, affiliates, employees, officers and directors from and against any and all liabilities, claims, penalties, forfeitures, suits and the costs and expenses incident thereto, including costs of defense, settlement, and reasonable attorney's fees, which may be incurred, as a result of death or injuries to any person, or damage to any property, contamination of or adverse effects on the environment, caused in whole or in part by the Customer, its employees, or subcontractors in disposing waste at this Facility. In the event Customer delivers Unacceptable Waste (as determined by Republic) Customer agrees to assume all expenses and obligations with the removal and/or resolution of any effects caused by the delivery of such Unacceptable Waste.

Indemnización. Cliente acuerda indemnizar, mantener inmune, y defender Republic Services, Inc., sus subsidiarios, compañías, divisiones, empleados, oficiales y directores contra de cualquiera y de todas responsabilidades, demandas, penas, pérdidas, juicios, pleitos y los costos incidente además, incluyendo costos de defensa, de acuerdo judicial, y de honorarios razonables del abogado, que pueden ser incurridos en, o como resultado de, la muerte o herida personal a cualquier persona, o daños a cualquier característica, propiedad, contaminación de la tierra o efectos ilícitos en esta Facilidad, causado entero o en parte por el cliente, sus empleados, o sus subcontratistas en botar basura en esta Facilidad. En el caso que el Cliente entrega, bota, basura (según lo determinado por Republic) en este Establecimiento basura inaceptable en los reglamentos de este Establecimiento, el Cliente se compromete asumir todos los costos y obligaciones con el retiro y/o la resolución de cualquier dano(s) causado por la entrega de tal basura inaceptable.



NON-HAZARDOUS WASTE MANIFEST

MANIFEST # 11986

GENERATOR INFORMATION

Generator Name: Tronox LLC
Address: P.O. Box 55
City: Henderson County: Clark
State: NV Zip: 89009
Site Location (if different): 560 W. Lake Mead
Henderson, NV 89015 (702) 592-7727

CUSTOMER/BILLING INFORMATION

Billing Name: NGE LLC c/o Northgate Environment Management
Address: 300 Frank Ogawa Plaza, Ste 510
City: Oakland County: Alameda
State: CA Zip: 94612

Table with 5 columns: Republic Services Approval #, Description of Waste, Volume/Weight, Expiration Date, Container Type. Row 1: 38251011244, Soil for disposal, 38.67 TL, 12-31-2011, Tractor with Dump Trailer(s).

*Attach Additional Sheet if necessary

I hereby certify that the above-described materials are non-hazardous wastes as defined by 40 CFR 261 or any applicable state law. Further, that the above named materials are properly classified, described, packaged, marked and labeled, and are in proper condition for transportation according to the applicable regulations of the Department of Transportation.

Susan Crowley (Signature)
Generator/Authorized Agent Name Signature Date Shipped

TRANSPORTER INFORMATION

Transporter Name: Las Vegas Paving DOT # 191949
Address: 4420 S. Decatur Truck Number: 192457
Las Vegas, NV 89103 Phone Number: (702) 353-4355

I certify no hazardous waste or other regulated substance was knowingly introduced to the waste while in my custody. The waste transported in this vehicle is the waste identified above, to the best of my knowledge.

Brian Brinkerhoff (Signature)
Name of Authorized Agent Signature Date Delivered 10-5-10

DISPOSAL SITE INFORMATION

Site Name: Apex Regional Landfill Phone No. (702) 599-5920
Address: 13550 U.S. Hwy 93 Las Vegas, NV

I hereby acknowledge receipt of the above described materials
Name (Print or Type) Signature Date Received 10-7-10

81 Environmental Tech
13550 N Highway 93
Las Vegas, NV 89165

Ticket Type: INBOUND INVOICE

Ticket Number: 1895
Date: 10/07/2010
Time In: 2:03 am
Time Out: 2:28 am

Customer: 001011 - NGE, LLC c/o Northgate Environ Mgmt

Vehicle/Container: 84598P
Contract: Northgate Env. On Site Soils 3825 11
Comment: 3825 10 11244

Gross Weight: 121,780 LB Manual In
Tare Weight: 51,880 LB Manual Out
Net Weight: 69900 LB
Net Tons: 34.95

BOL: 11988

Origin	Yards	Material	Billing	Quantity
Not Applicable	0.00 YD	SW CONTAMINATED SOIL	34.95	TN

Driver: _____

Weighmaster: _____

SMITHJ

Indemnification. Customer agrees, by signature above, to indemnify, hold harmless, and defend Republic Services, Inc., its subsidiaries, affiliates, employees, officers and directors from and against any and all liabilities, claims, penalties, forfeitures, suits and the costs and expenses incident thereto, including costs of defense, settlement, and reasonable attorney's fees, which may be incurred, as a result of death or injuries to any person, or damage to any property, contamination of or adverse effects on the environment, caused in whole or in part by the Customer, its employees, or subcontractors in disposing waste at this Facility. In the event Customer delivers Unacceptable Waste (as determined by Republic) Customer agrees to assume all expenses and obligations with the removal and/or resolution of any effects caused by the delivery of such Unacceptable Waste.

Indemnización. Cliente acuerda indemnizar, mantener inmune, y defender Republic Services, Inc., sus subsidiarios, compañías, divisiones, empleados, oficiales y directores contra de cualquiera y de todas responsabilidades, demandas, penas, pérdidas, juicios, pleitos y los costos incidente además, incluyendo costos de defensa, de acuerdo judicial, y de honorarios razonables del abogado, que pueden ser incurridos en, o como resultado de, la muerte o herida personal a cualquier persona, o daños a cualquier característica, propiedad, contaminación de la tierra o efectos ilícitos en esta Facilidad, causado entero o en parte por el cliente, sus empleados, o sus subcontratistas en botar basura en esta Facilidad. En el caso que el Cliente entrega, bota, basura (según lo determinado por Republic) en este Establecimiento basura inaceptable en los reglamentos de este Establecimiento, el Cliente se compromete asumir todos los costos y obligaciones con el retiro y/o la resolución de cualquier dano(s) causado por la entrega de tal basura inaceptable.



NON-HAZARDOUS WASTE MANIFEST

MANIFEST # 11988

GENERATOR INFORMATION

Generator Name: Tronox LLC
Address: P.O. Box 55
City: Henderson County: Clark
State: NV Zip: 89009
Site Location (if different): 560 W. Lake Mead
Henderson, NV 89015 (702) 592-7727

CUSTOMER/BILLING INFORMATION

Billing Name: NGE LLC c/o Northgate Environment Management
Address: 300 Frank Ogawa Plaza, Ste 510
City: Oakland County: Alameda
State: CA Zip: 94612

Table with 5 columns: Republic Services Approval #, Description of Waste, Volume/Weight, Expiration Date, Container Type. Row 1: 38251011244, Soil for disposal, 34.9570, 12-31-2011, Tractor with Dump Trailer(s). Row 2: RZ- #

*Attach Additional Sheet if necessary

I hereby certify that the above-described materials are non-hazardous wastes as defined by 40 CFR 261 or any applicable state law. Further, that the above named materials are properly classified, described, packaged, marked and labeled, and are in proper condition for transportation according to the applicable regulations of the Department of Transportation.

Susan Crowley (Signature)
Generator/Authorized Agent Name Signature Date Shipped

TRANSPORTER INFORMATION

Transporter Name: Las Vegas Paving DOT # 191949
Address: 4420 S. Decatur Truck Number: 18
Las Vegas, NV 89103 Phone Number: (702) 353-4355

I certify no hazardous waste or other regulated substance was knowingly introduced to the waste while in my custody. The waste transported in this vehicle is the waste identified above, to the best of my knowledge.

KYALGI (Signature)
Name of Authorized Agent Signature Date Delivered 10-07-10

DISPOSAL SITE INFORMATION

Site Name: Apex Regional Landfill Phone No. (702) 599-5920
Address: 13550 U.S. Hwy 93 Las Vegas, NV

I hereby acknowledge receipt of the above described materials
Name (Print or Type) Signature Date Received 10-7-10

81 Environmental Tech
13550 N Highway 93
Las Vegas, NV 89165

Ticket Type: INBOUND INVOICE

Ticket Number: 1896
Date: 10/07/2010
Time In: 2:01 am
Time Out: 2:28 am

Customer: 001011 - NGE, LLC c/o Northgate Environ Mgmt

Vehicle/Container: 44166A
Contract: Northgate Env. On Site Soils 3825 11
Comment: 3825 10 11244

Gross Weight: 136,060 LB Manual In
Tare Weight: 57,280 LB Manual Out
Net Weight: 78780 LB
Net Tons: 39.39

BOL: 11987

Origin	Yards	Material	Billing	Quantity
Not Applicable	0.00 YD	SW CONTAMINATED SOIL	39.39	TN

Driver: _____



Weighmaster: _____

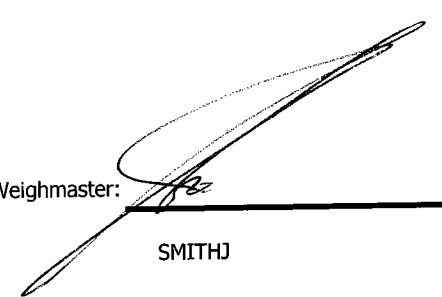

SMITHJ

Indemnification. Customer agrees, by signature above, to indemnify, hold harmless, and defend Republic Services, Inc., its subsidiaries, affiliates, employees, officers and directors from and against any and all liabilities, claims, penalties, forfeitures, suits and the costs and expenses incident thereto, including costs of defense, settlement, and reasonable attorney's fees, which may be incurred, as a result of death or injuries to any person, or damage to any property, contamination of or adverse effects on the environment, caused in whole or in part by the Customer, its employees, or subcontractors in disposing waste at this Facility. In the event Customer delivers Unacceptable Waste (as determined by Republic) Customer agrees to assume all expenses and obligations with the removal and/or resolution of any effects caused by the delivery of such Unacceptable Waste.

Indemnización. Cliente acuerda indemnizar, mantener inmune, y defender Republic Services, Inc., sus subsidiarios, compañías, divisiones, empleados, oficiales y directores contra de cualquiera y de todas responsabilidades, demandas, penas, pérdidas, juicios, pleitos y los costos incidente además, incluyendo costos de defensa, de acuerdo judicial, y de honorarios razonables del abogado, que pueden ser incurridos en, o como resultado de, la muerte o herida personal a cualquier persona, o daños a cualquier característica, propiedad, contaminación de la tierra o efectos ilícitos en esta Facilidad, causado entero o en parte por el cliente, sus empleados, o sus subcontratistas en botar basura en esta Facilidad. En el caso que el Cliente entrega, bota, basura (según lo determinado por Republic) en este Establecimiento basura inaceptable en los reglamentos de este Establecimiento, el Cliente se compromete asumir todos los costos y obligaciones con el retiro y/o la resolución de cualquier dano(s) causado por la entrega de tal basura inaceptable.



NON-HAZARDOUS WASTE MANIFEST

MANIFEST # 11987

GENERATOR INFORMATION

Generator Name: Tronox LLC

Address: P.O. Box 55

City: Henderson County: Clark

State: NV Zip: 89009

Site Location (if different): 560 W. Lake Mead

Henderson, NV 89015 (702) 592-7727

CUSTOMER/BILLING INFORMATION

Billing Name: NGE LLC c/o Northgate Environment Management

Address: 300 Frank Ogawa Plaza, Ste 510

City: Oakland County: Alameda

State: CA Zip: 94612

Republic Services Approval #	Description of Waste	Volume/Weight	Expiration Date	Container Type
38251011244	Soil for disposal		12-31-2011	Tractor with Dump Trailer(s)
	RZ- _____ # _____	37.39 76		

*Attach Additional Sheet if necessary

I hereby certify that the above-described materials are non-hazardous wastes as defined by 40 CFR 261 or any applicable state law. Further, that the above named materials are properly classified, described, packaged, marked and labeled, and are in proper condition for transportation according to the applicable regulations of the Department of Transportation.

Susan Crowley (Signature) Generator/Authorized Agent Name Signature Date Shipped

TRANSPORTER INFORMATION

Transporter Name: Las Vegas Paving

DOT # 191949

Address: 4420 S. Decatur

Truck Number: K002

Las Vegas, NV 89103

Phone Number: (702) 353-4355

I certify no hazardous waste or other regulated substance was knowingly introduced to the waste while in my custody. The waste transported in this vehicle is the waste identified above, to the best of my knowledge.

Hugo Castell (Signature) Name of Authorized Agent Signature Date Delivered 10-6-10

DISPOSAL SITE INFORMATION

Site Name: Apex Regional Landfill

Phone No. (702) 599-5920

Address: 13550 U.S. Hwy 93 Las Vegas, NV

I hereby acknowledge receipt of the above described materials

(Signature) Name (Print or Type) Signature Date Received 10-7-10

81 Environmental Tech
13550 N Highway 93
Las Vegas, NV 89165

Ticket Type: INBOUND INVOICE

Ticket Number: 1897
Date: 10/07/2010
Time In: 2:02 am
Time Out: 2:31 am

Customer: 001011 - NGE, LLC c/o Northgate Environ Mgmt

Vehicle/Container: 192456
Contract: Northgate Env. On Site Soils 3825 11
Comment: 3825 10 11244

Gross Weight: 123,560 LB Manual In
Tare Weight: 52,780 LB Manual Out
Net Weight: 70780 LB
Net Tons: 35.39

BOL: 11989

Origin	Yards	Material	Billing	Quantity
Not Applicable	0.00 YD	SW CONTAMINATED SOIL	35.39	TN

Driver: _____

Weighmaster: _____

SMITHJ

Indemnification. Customer agrees, by signature above, to indemnify, hold harmless, and defend Republic Services, Inc., its subsidiaries, affiliates, employees, officers and directors from and against any and all liabilities, claims, penalties, forfeitures, suits and the costs and expenses incident thereto, including costs of defense, settlement, and reasonable attorney's fees, which may be incurred, as a result of death or injuries to any person, or damage to any property, contamination of or adverse effects on the environment, caused in whole or in part by the Customer, its employees, or subcontractors in disposing waste at this Facility. In the event Customer delivers Unacceptable Waste (as determined by Republic) Customer agrees to assume all expenses and obligations with the removal and/or resolution of any effects caused by the delivery of such Unacceptable Waste.

Indemnización. Cliente acuerda indemnizar, mantener inmune, y defender Republic Services, Inc., sus subsidiarios, compañías, divisiones, empleados, oficiales y directores contra de cualquiera y de todas responsabilidades, demandas, penas, pérdidas, juicios, pleitos y los costos incidente además, incluyendo costos de defensa, de acuerdo judicial, y de honorarios razonables del abogado, que pueden ser incurridos en, o como resultado de, la muerte o herida personal a cualquier persona, o daños a cualquier característica, propiedad, contaminación de la tierra o efectos ilícitos en esta Facilidad, causado entero o en parte por el cliente, sus empleados, o sus subcontratistas en botar basura en esta Facilidad. En el caso que el Cliente entrega, bota, basura (según lo determinado por Republic) en este Establecimiento basura inaceptable en los reglamentos de este Establecimiento, el Cliente se compromete asumir todos los costos y obligaciones con el retiro y/o la resolución de cualquier dano(s) causado por la entrega de tal basura inaceptable.



NON-HAZARDOUS WASTE MANIFEST

MANIFEST # 11989

GENERATOR INFORMATION

Generator Name: Tronox LLC

Address: P.O. Box 55

City: Henderson County: Clark

State: NV Zip: 89009

Site Location (if different): 560 W. Lake Mead
Henderson, NV 89015 (702) 592-7727

CUSTOMER/BILLING INFORMATION

Billing Name: NGE LLC c/o Northgate Environment Management

Address: 300 Frank Ogawa Plaza, Ste 510

City: Oakland County: Alameda

State: CA Zip: 94612

Table with 5 columns: Republic Services Approval #, Description of Waste, Volume/Weight, Expiration Date, Container Type. Row 1: 38251011244, Soil for disposal, 35.32 TN, 12-31-2011, Tractor with Dump Trailer(s).

*Attach Additional Sheet if necessary

I hereby certify that the above-described materials are non-hazardous wastes as defined by 40 CFR 261 or any applicable state law. Further, that the above named materials are properly classified, described, packaged, marked and labeled, and are in proper condition for transportation according to the applicable regulations of the Department of Transportation.

Susan Crowley (Signature)
Generator/Authorized Agent Name Signature Date Shipped

TRANSPORTER INFORMATION

Transporter Name: Las Vegas Paving

DOT # 191949

Address: 4420 S. Decatur

Truck Number: 192456

Las Vegas, NV 89103

Phone Number: (702) 353-4355

I certify no hazardous waste or other regulated substance was knowingly introduced to the waste while in my custody. The waste transported in this vehicle is the waste identified above, to the best of my knowledge.

(Signature) (Signature) 10/6/10
Name of Authorized Agent Signature Date Delivered

DISPOSAL SITE INFORMATION

Site Name: Apex Regional Landfill

Phone No. (702) 599-5920

Address: 13550 U.S. Hwy 93 Las Vegas, NV

I hereby acknowledge receipt of the above described materials
Name (Print or Type) Signature Date Received 10-7-10

81 Environmental Tech
13550 N Highway 93
Las Vegas, NV 89165

Ticket Type: INBOUND INVOICE

Ticket Number: 1898
Date: 10/07/2010
Time In: 2:09 am
Time Out: 2:37 am

Customer: 001011 - NGE, LLC c/o Northgate Environ Mgmt

Vehicle/Container: 192460
Contract: Northgate Env. On Site Soils 3825 11
Comment: 3825 10 11244

Gross Weight: 126,060 LB Manual In
Tare Weight: 53,160 LB Manual Out
Net Weight: 72900 LB
Net Tons: 36.45

BOL: 11990

Origin	Yards	Material	Billing Quantity
Not Applicable	0.00 YD	SW CONTAMINATED SOIL	36.45 TN

Driver:

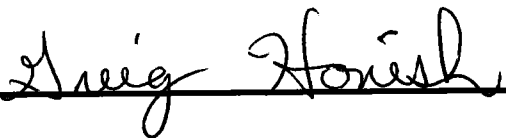

Weighmaster:

SMITHJ

Indemnification. Customer agrees, by signature above, to indemnify, hold harmless, and defend Republic Services, Inc., its subsidiaries, affiliates, employees, officers and directors from and against any and all liabilities, claims, penalties, forfeitures, suits and the costs and expenses incident thereto, including costs of defense, settlement, and reasonable attorney's fees, which may be incurred, as a result of death or injuries to any person, or damage to any property, contamination of or adverse effects on the environment, caused in whole or in part by the Customer, its employees, or subcontractors in disposing waste at this Facility. In the event Customer delivers Unacceptable Waste (as determined by Republic) Customer agrees to assume all expenses and obligations with the removal and/or resolution of any effects caused by the delivery of such Unacceptable Waste.

Indemnización. Cliente acuerda indemnizar, mantener inmune, y defender Republic Services, Inc., sus subsidiarios, compañías, divisiones, empleados, oficiales y directores contra de cualquiera y de todas responsabilidades, demandas, penas, pérdidas, juicios, pleitos y los costos incidente además, incluyendo costos de defensa, de acuerdo judicial, y de honorarios razonables del abogado, que pueden ser incurridos en, o como resultado de, la muerte o herida personal a cualquier persona, o daños a cualquier característica, propiedad, contaminación de la tierra o efectos ilícitos en esta Facilidad, causado entero o en parte por el cliente, sus empleados, o sus subcontratistas en botar basura en esta Facilidad. En el caso que el Cliente entrega, bota, basura (según lo determinado por Republic) en este Establecimiento basura inaceptable en los reglamentos de este Establecimiento, el Cliente se compromete asumir todos los costos y obligaciones con el retiro y/o la resolución de cualquier dano(s) causado por la entrega de tal basura inaceptable.



NON-HAZARDOUS WASTE MANIFEST

MANIFEST # 11990

GENERATOR INFORMATION

Generator Name: Tronox LLC

Address: P.O. Box 55

City: Henderson County: Clark

State: NV Zip: 89009

Site Location (if different): 560 W. Lake Mead

Henderson, NV 89015 (702) 592-7727

CUSTOMER/BILLING INFORMATION

Billing Name: NGE LLC c/o Northgate Environment Management

Address: 300 Frank Ogawa Plaza, Ste 510

City: Oakland County: Alameda

State: CA Zip: 94612

Republic Services Approval #	Description of Waste	Volume/Weight	Expiration Date	Container Type
38251011244	Soil for disposal		12-31-2011	Tractor with Dump Trailer(s)
	RZ- _____ # _____	2.45 TON		

*Attach Additional Sheet if necessary

I hereby certify that the above-described materials are non-hazardous wastes as defined by 40 CFR 261 or any applicable state law. Further, that the above named materials are properly classified, described, packaged, marked and labeled, and are in proper condition for transportation according to the applicable regulations of the Department of Transportation.

Susan Crowley Generator/Authorized Agent Name Signature Date Shipped

TRANSPORTER INFORMATION

Transporter Name: Las Vegas Paving

DOT # 191949

Address: 4420 S. Decatur

Truck Number: 2460

Las Vegas, NV 89103

Phone Number: (702) 353-4355

I certify no hazardous waste or other regulated substance was knowingly introduced to the waste while in my custody. The waste transported in this vehicle is the waste identified above, to the best of my knowledge.

Gregg Honish Name of Authorized Agent Signature Date Delivered 10-6-10

DISPOSAL SITE INFORMATION

Site Name: Apex Regional Landfill

Phone No. (702) 599-5920

Address: 13550 U.S. Hwy 93 Las Vegas, NV

I hereby acknowledge receipt of the above described materials Name (Print or Type) Signature Date Received

81 Environmental Tech
13550 N Highway 93
Las Vegas, NV 89165

Ticket Type: INBOUND INVOICE

Ticket Number: 1899
Date: 10/07/2010
Time In: 2:22 am
Time Out: 2:42 am

Customer: 001011 - NGE, LLC c/o Northgate Environ Mgmt

Vehicle/Container: 81496P
Contract: Northgate Env. On Site Soils 3825 11
Comment: 3825 10 11244

Gross Weight: 114,880 LB Manual In
Tare Weight: 50,660 LB Manual Out
Net Weight: 64220 LB
Net Tons: 32.11

BOL: 11991

Origin	Yards	Material	Billing Quantity
Not Applicable	0.00 YD	SW CONTAMINATED SOIL	32.11 TN

Driver: _____



Weighmaster: _____

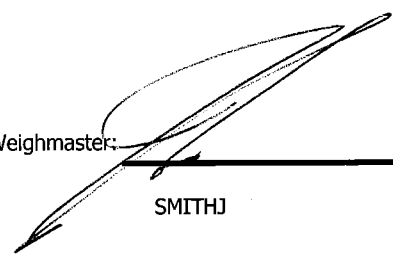

SMITHJ

Indemnification. Customer agrees, by signature above, to indemnify, hold harmless, and defend Republic Services, Inc., its subsidiaries, affiliates, employees, officers and directors from and against any and all liabilities, claims, penalties, forfeitures, suits and the costs and expenses incident thereto, including costs of defense, settlement, and reasonable attorney's fees, which may be incurred, as a result of death or injuries to any person, or damage to any property, contamination of or adverse effects on the environment, caused in whole or in part by the Customer, its employees, or subcontractors in disposing waste at this Facility. In the event Customer delivers Unacceptable Waste (as determined by Republic) Customer agrees to assume all expenses and obligations with the removal and/or resolution of any effects caused by the delivery of such Unacceptable Waste.

Indemnización. Cliente acuerda indemnizar, mantener inmune, y defender Republic Services, Inc., sus subsidiarios, compañías, divisiones, empleados, oficiales y directores contra de cualquiera y de todas responsabilidades, demandas, penas, pérdidas, juicios, pleitos y los costos incidente además, incluyendo costos de defensa, de acuerdo judicial, y de honorarios razonables del abogado, que pueden ser incurridos en, o como resultado de, la muerte o herida personal a cualquier persona, o daños a cualquier característica, propiedad, contaminación de la tierra o efectos ilícitos en esta Facilidad, causado entero o en parte por el cliente, sus empleados, o sus subcontratistas en botar basura en esta Facilidad. En el caso que el Cliente entrega, bota, basura (según lo determinado por Republic) en este Establecimiento basura inaceptable en los reglamentos de este Establecimiento, el Cliente se compromete asumir todos los costos y obligaciones con el retiro y/o la resolución de cualquier dano(s) causado por la entrega de tal basura inaceptable.



NON-HAZARDOUS WASTE MANIFEST

MANIFEST # 11991

GENERATOR INFORMATION

Generator Name: Tronox LLC

Address: P.O. Box 55

City: Henderson County: Clark

State: NV Zip: 89009

Site Location (if different): 560 W. Lake Mead

Henderson, NV 89015 (702) 592-7727

CUSTOMER/BILLING INFORMATION

Billing Name: NGE LLC c/o Northgate Environment Management

Address: 300 Frank Ogawa Plaza, Ste 510

City: Oakland County: Alameda

State: CA Zip: 94612

Table with 5 columns: Republic Services Approval #, Description of Waste, Volume/Weight, Expiration Date, Container Type. Row 1: 38251011244, Soil for disposal, 2.11 TON, 12-31-2011, Tractor with Dump Trailer(s). Row 2: RZ- #

*Attach Additional Sheet if necessary

I hereby certify that the above-described materials are non-hazardous wastes as defined by 40 CFR 261 or any applicable state law. Further, that the above named materials are properly classified, described, packaged, marked and labeled, and are in proper condition for transportation according to the applicable regulations of the Department of Transportation.

Susan Crowley (Signature) Generator/Authorized Agent Name Signature Date Shipped

TRANSPORTER INFORMATION

Transporter Name: Las Vegas Paving

DOT # 191949

Address: 4420 S. Decatur

Truck Number: 145

Las Vegas, NV 89103

Phone Number: (702) 353-4355

I certify no hazardous waste or other regulated substance was knowingly introduced to the waste while in my custody. The waste transported in this vehicle is the waste identified above, to the best of my knowledge.

Hay M. Bick (Signature) Name of Authorized Agent Signature Date Delivered 10-6-10

DISPOSAL SITE INFORMATION

Site Name: Apex Regional Landfill

Phone No. (702) 599-5920

Address: 13550 U.S. Hwy 93 Las Vegas, NV

I hereby acknowledge receipt of the above described materials (Signature) Name (Print or Type) Signature Date Received 10-7-10

81 Environmental Tech
13550 N Highway 93
Las Vegas, NV 89165

Ticket Type: INBOUND INVOICE

Ticket Number: 1900
Date: 10/07/2010
Time In: 2:25 am
Time Out: 2:48 am

Customer: 001011 - NGE, LLC c/o Northgate Environ Mgmt

Vehicle/Container: 81495P
Contract: Northgate Env. On Site Soils 3825 11
Comment: 3825 10 11244

Gross Weight: 117,300 LB Manual In
Tare Weight: 53,340 LB Manual Out
Net Weight: 63,960 LB
Net Tons: 31.98

BOL: 11992

Origin	Yards	Material	Billing	Quantity
Not Applicable	0.00 YD	SW CONTAMINATED SOIL	31.98	TN

Driver:

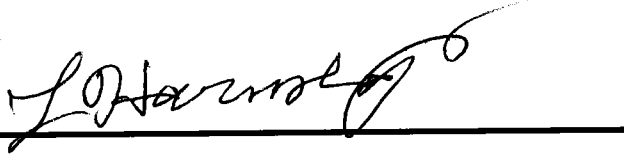

Weighmaster:

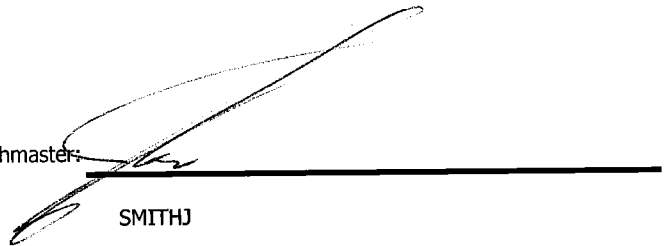

SMITHJ

Indemnification. Customer agrees, by signature above, to indemnify, hold harmless, and defend Republic Services, Inc., its subsidiaries, affiliates, employees, officers and directors from and against any and all liabilities, claims, penalties, forfeitures, suits and the costs and expenses incident thereto, including costs of defense, settlement, and reasonable attorney's fees, which may be incurred, as a result of death or injuries to any person, or damage to any property, contamination of or adverse effects on the environment, caused in whole or in part by the Customer, its employees, or subcontractors in disposing waste at this Facility. In the event Customer delivers Unacceptable Waste (as determined by Republic) Customer agrees to assume all expenses and obligations with the removal and/or resolution of any effects caused by the delivery of such Unacceptable Waste.

Indemnización. Cliente acuerda indemnizar, mantener inmune, y defender Republic Services, Inc., sus subsidiarios, compañías, divisiones, empleados, oficiales y directores contra de cualquiera y de todas responsabilidades, demandas, penas, pérdidas, juicios, pleitos y los costos incidente además, incluyendo costos de defensa, de acuerdo judicial, y de honorarios razonables del abogado, que pueden ser incurridos en, o como resultado de, la muerte o herida personal a cualquier persona, o daños a cualquier característica, propiedad, contaminación de la tierra o efectos ilícitos en esta Facilidad, causado entero o en parte por el cliente, sus empleados, o sus subcontratistas en botar basura en esta Facilidad. En el caso que el Cliente entrega, bota, basura (según lo determinado por Republic) en este Establecimiento basura inaceptable en los reglamentos de este Establecimiento, el Cliente se compromete asumir todos los costos y obligaciones con el retiro y/o la resolución de cualquier dano(s) causado por la entrega de tal basura inaceptable.



SR 40238
NON-HAZARDOUS WASTE MANIFEST

MANIFEST # 11992

GENERATOR INFORMATION

Generator Name: Tronox LLC
 Address: P.O. Box 55
 City: Henderson County: Clark
 State: NV Zip: 89009
 Site Location (if different): 560 W. Lake Mead
Henderson, NV 89015 (702) 592-7727

CUSTOMER/BILLING INFORMATION

Billing Name: NGE LLC c/o Northgate Environment Management
 Address: 300 Frank Ogawa Plaza, Ste 510
 City: Oakland County: Alameda
 State: CA Zip: 94612

Republic Services Approval #	Description of Waste	Volume/Weight	Expiration Date	Container Type
38251011244	Soil for disposal		12-31-2011	Tractor with Dump Trailer(s)
	RZ- _____ # _____	31.98 TN		

*Attach Additional Sheet if necessary

I hereby certify that the above-described materials are non-hazardous wastes as defined by 40 CFR 261 or any applicable state law. Further, that the above named materials are properly classified, described, packaged, marked and labeled, and are in proper condition for transportation according to the applicable regulations of the Department of Transportation.

Susan Crowley [Signature] _____
 Generator/Authorized Agent Name Signature Date Shipped

TRANSPORTER INFORMATION

Transporter Name: Las Vegas Paving DOT # 191949
 Address: 4420 S. Decatur Truck Number: 175
Las Vegas, NV 89103 Phone Number: (702) 353-4355

I certify no hazardous waste or other regulated substance was knowingly introduced to the waste while in my custody. The waste transported in this vehicle is the waste identified above, to the best of my knowledge.

Larry Harnsberger [Signature] 10-6-10
 Name of Authorized Agent Signature Date Delivered

DISPOSAL SITE INFORMATION

Site Name: Apex Regional Landfill Phone No. (702) 599-5920
 Address: 13550 U.S. Hwy 93 Las Vegas, NV

I hereby acknowledge receipt of the above described materials
[Signature] _____
 Name (Print or Type) Signature Date Received

81 Environmental Tech
13550 N Highway 93
Las Vegas, NV 89165

Ticket Type: INBOUND INVOICE

Ticket Number: 1901
Date: 10/07/2010
Time In: 2:26 am
Time Out: 2:50 am

Customer: 001011 - NGE, LLC c/o Northgate Environ Mgmt

Vehicle/Container: 81494P
Contract: Northgate Env. On Site Soils 3825 11
Comment: 3825 10 11244

Gross Weight: 114,920 LB Manual In
Tare Weight: 51,580 LB Manual Out
Net Weight: 63340 LB
Net Tons: 31.67

BOL: 11993

Origin	Yards	Material	Billing Quantity
Not Applicable	0.00 YD	SW CONTAMINATED SOIL	31.67 TN

Driver:



Weighmaster:

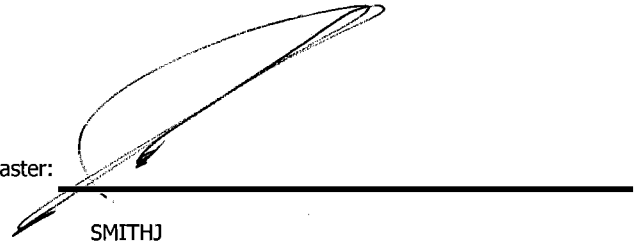

SMITHJ

Indemnification. Customer agrees, by signature above, to indemnify, hold harmless, and defend Republic Services, Inc., its subsidiaries, affiliates, employees, officers and directors from and against any and all liabilities, claims, penalties, forfeitures, suits and the costs and expenses incident thereto, including costs of defense, settlement, and reasonable attorney's fees, which may be incurred, as a result of death or injuries to any person, or damage to any property, contamination of or adverse effects on the environment, caused in whole or in part by the Customer, its employees, or subcontractors in disposing waste at this Facility. In the event Customer delivers Unacceptable Waste (as determined by Republic) Customer agrees to assume all expenses and obligations with the removal and/or resolution of any effects caused by the delivery of such Unacceptable Waste.

Indemnización. Cliente acuerda indemnizar, mantener inmune, y defender Republic Services, Inc., sus subsidiarios, companias, divisiones, empleados, oficiales y directores contra de cualquiera y de todas responsabilidades, demandas, penas, pérdidas, juicios, pleitos y los costos incidente además, incluyendo costos de defensa, de acuerdo judicial, y de honorarios razonables del abogado, que pueden ser incurridos en, o como resultado de, la muerte o herida personal a cualquier persona, o daños a cualquier característica, propiedad, contaminación de la tierra o efectos ilicitos en esta Facilidad, causado entero o en parte por el cliente, sus empleados, o sus subcontratistas en botar basura en esta Facilidad. En el caso que el Cliente entrega, bota, basura (según lo determinado por Republic) en este Establecimiento basura inaceptable en los reglamentos de este Establecimiento, el Cliente se compromete asumir todos los costos y obligaciones con el retiro y/o la resolución de cualquier dano(s) causado por la entrega de tal basura inaceptable.



NON-HAZARDOUS WASTE MANIFEST

MANIFEST # 11993

GENERATOR INFORMATION

Generator Name: Tronox LLC

Address: P.O. Box 55

City: Henderson County: Clark

State: NV Zip: 89009

Site Location (if different): 560 W. Lake Mead

Henderson, NV 89015 (702) 592-7727

CUSTOMER/BILLING INFORMATION

Billing Name: NGE LLC c/o Northgate Environment Management

Address: 300 Frank Ogawa Plaza, Ste 510

City: Oakland County: Alameda

State: CA Zip: 94612

Table with 5 columns: Republic Services Approval #, Description of Waste, Volume/Weight, Expiration Date, Container Type. Row 1: 38251011244, Soil for disposal, 31.67 TN, 12-31-2011, Tractor with Dump Trailer(s). Row 2: RZ- #

*Attach Additional Sheet if necessary

I hereby certify that the above-described materials are non-hazardous wastes as defined by 40 CFR 261 or any applicable state law. Further, that the above named materials are properly classified, described, packaged, marked and labeled, and are in proper condition for transportation according to the applicable regulations of the Department of Transportation.

Susan Crowley (Signature) Generator/Authorized Agent Name Date Shipped

TRANSPORTER INFORMATION

Transporter Name: Las Vegas Paving

DOT # 191949

Address: 4420 S. Decatur

Truck Number: 125

Las Vegas, NV 89103

Phone Number: (702) 353-4355

I certify no hazardous waste or other regulated substance was knowingly introduced to the waste while in my custody. The waste transported in this vehicle is the waste identified above, to the best of my knowledge.

Calvin Pego (Signature) Name of Authorized Agent Date Delivered 10-06-10

DISPOSAL SITE INFORMATION

Site Name: Apex Regional Landfill

Phone No. (702) 599-5920

Address: 13550 U.S. Hwy 93 Las Vegas, NV

I hereby acknowledge receipt of the above described materials

(Signature) Name (Print or Type) Signature Date Received 10-2-10

81 Environmental Tech
13550 N Highway 93
Las Vegas, NV 89165

Ticket Type: INBOUND INVOICE

Ticket Number: 1902
Date: 10/07/2010
Time In: 2:32 am
Time Out: 2:53 am

Customer: 001011 - NGE, LLC c/o Northgate Environ Mgmt

Vehicle/Container: 86053P
Contract: Northgate Env. On Site Soils 3825 11
Comment: 3825 10 11244

Gross Weight: 119,140 LB Manual In
Tare Weight: 56,560 LB Manual Out
Net Weight: 62580 LB
Net Tons: 31.29

BOL: 11995

Origin	Yards	Material	Billing Quantity
Not Applicable	0.00 YD	SW CONTAMINATED SOIL	31.29 TN

Driver: _____



Weighmaster: _____

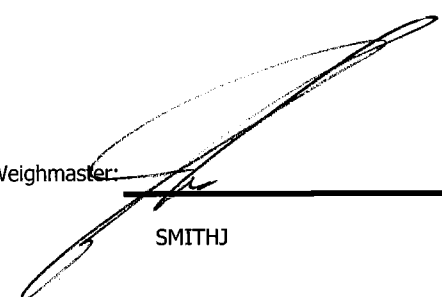

SMITHJ

Indemnification. Customer agrees, by signature above, to indemnify, hold harmless, and defend Republic Services, Inc., its subsidiaries, affiliates, employees, officers and directors from and against any and all liabilities, claims, penalties, forfeitures, suits and the costs and expenses incident thereto, including costs of defense, settlement, and reasonable attorney's fees, which may be incurred, as a result of death or injuries to any person, or damage to any property, contamination of or adverse effects on the environment, caused in whole or in part by the Customer, its employees, or subcontractors in disposing waste at this Facility. In the event Customer delivers Unacceptable Waste (as determined by Republic) Customer agrees to assume all expenses and obligations with the removal and/or resolution of any effects caused by the delivery of such Unacceptable Waste.

Indemnización. Cliente acuerda indemnizar, mantener inmune, y defender Republic Services, Inc., sus subsidiarios, compañías, divisiones, empleados, oficiales y directores contra de cualquiera y de todas responsabilidades, demandas, penas, pérdidas, juicios, pleitos y los costos incidente además, incluyendo costos de defensa, de acuerdo judicial, y de honorarios razonables del abogado, que pueden ser incurridos en, o como resultado de, la muerte o herida personal a cualquier persona, o daños a cualquier característica, propiedad, contaminación de la tierra o efectos ilícitos en esta Facilidad, causado entero o en parte por el cliente, sus empleados, o sus subcontratistas en botar basura en esta Facilidad. En el caso que el Cliente entrega, bota, basura (según lo determinado por Republic) en este Establecimiento basura inaceptable en los reglamentos de este Establecimiento, el Cliente se compromete asumir todos los costos y obligaciones con el retiro y/o la resolución de cualquier dano(s) causado por la entrega de tal basura inaceptable.



NON-HAZARDOUS WASTE MANIFEST

MANIFEST # 11995

GENERATOR INFORMATION

Generator Name: Tronox LLC
Address: P.O. Box 55
City: Henderson County: Clark
State: NV Zip: 89009
Site Location (if different): 560 W. Lake Mead
Henderson, NV 89015 (702) 592-7727

CUSTOMER/BILLING INFORMATION

Billing Name: NGE LLC c/o Northgate Environment Management
Address: 300 Frank Ogawa Plaza, Ste 510
City: Oakland County: Alameda
State: CA Zip: 94612

Table with 5 columns: Republic Services Approval #, Description of Waste, Volume/Weight, Expiration Date, Container Type. Row 1: 38251011244, Soil for disposal, 76,271 lb, 12-31-2011, Tractor with Dump Trailer(s).

*Attach Additional Sheet if necessary

I hereby certify that the above-described materials are non-hazardous wastes as defined by 40 CFR 261 or any applicable state law. Further, that the above named materials are properly classified, described, packaged, marked and labeled, and are in proper condition for transportation according to the applicable regulations of the Department of Transportation.

Susan Crowley (Signature)
Generator/Authorized Agent Name Signature Date Shipped

TRANSPORTER INFORMATION

Transporter Name: Las Vegas Paving DOT # 191949
Address: 4420 S. Decatur Truck Number: 2601
Las Vegas, NV 89103 Phone Number: (702) 353-4355

I certify no hazardous waste or other regulated substance was knowingly introduced to the waste while in my custody. The waste transported in this vehicle is the waste identified above, to the best of my knowledge.

Name of Authorized Agent Signature Date Delivered

DISPOSAL SITE INFORMATION

Site Name: Apex Regional Landfill Phone No. (702) 599-5920
Address: 13550 U.S. Hwy 93 Las Vegas, NV

I hereby acknowledge receipt of the above described materials

Name (Print or Type) Signature Date Received

81 Environmental Tech
13550 N Highway 93
Las Vegas, NV 89165

Ticket Type: INBOUND INVOICE

Ticket Number: 1903
Date: 10/07/2010
Time In: 2:45 am
Time Out: 3:08 am

Customer: 001011 - NGE, LLC c/o Northgate Environ Mgmt

Vehicle/Container: 82418P
Contract: Northgate Env. On Site Soils 3825 11
Comment: 3825 10 11244

Gross Weight: 128,360 LB Manual In
Tare Weight: 65,260 LB Manual Out
Net Weight: 63100 LB
Net Tons: 31.55

BOL: 11994

Origin	Yards	Material	Billing Quantity
Not Applicable	0.00 YD	SW CONTAMINATED SOIL	31.55 TN

Driver: _____

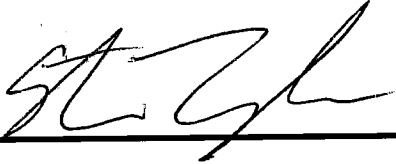

Weighmaster: _____

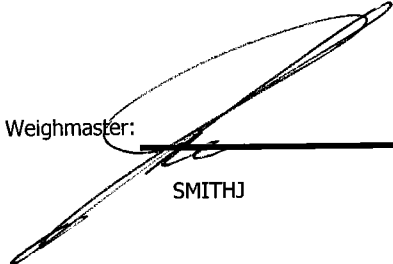

SMITHJ

Indemnification. Customer agrees, by signature above, to indemnify, hold harmless, and defend Republic Services, Inc., its subsidiaries, affiliates, employees, officers and directors from and against any and all liabilities, claims, penalties, forfeitures, suits and the costs and expenses incident thereto, including costs of defense, settlement, and reasonable attorney's fees, which may be incurred, as a result of death or injuries to any person, or damage to any property, contamination of or adverse effects on the environment, caused in whole or in part by the Customer, its employees, or subcontractors in disposing waste at this Facility. In the event Customer delivers Unacceptable Waste (as determined by Republic) Customer agrees to assume all expenses and obligations with the removal and/or resolution of any effects caused by the delivery of such Unacceptable Waste.

Indemnización. Cliente acuerda indemnizar, mantener inmune, y defender Republic Services, Inc., sus subsidiarios, compañías, divisiones, empleados, oficiales y directores contra de cualquiera y de todas responsabilidades, demandas, penas, pérdidas, juicios, pleitos y los costos incidente además, incluyendo costos de defensa, de acuerdo judicial, y de honorarios razonables del abogado, que pueden ser incurridos en, o como resultado de, la muerte o herida personal a cualquier persona, o daños a cualquier característica, propiedad, contaminación de la tierra o efectos ilícitos en esta Facilidad, causado entero o en parte por el cliente, sus empleados, o sus subcontratistas en botar basura en esta Facilidad. En el caso que el Cliente entrega, bota, basura (según lo determinado por Republic) en este Establecimiento basura inaceptable en los reglamentos de este Establecimiento, el Cliente se compromete asumir todos los costos y obligaciones con el retiro y/o la resolución de cualquier dano(s) causado por la entrega de tal basura inaceptable.



NON-HAZARDOUS WASTE MANIFEST

MANIFEST # 11994

GENERATOR INFORMATION

Generator Name: Tronox LLC

Address: P.O. Box 55

City: Henderson County: Clark

State: NV Zip: 89009

Site Location (if different): 560 W. Lake Mead

Henderson, NV 89015 (702) 592-7727

CUSTOMER/BILLING INFORMATION

Billing Name: NGE LLC c/o Northgate Environment Management

Address: 300 Frank Ogawa Plaza, Ste 510

City: Oakland County: Alameda

State: CA Zip: 94612

Table with 5 columns: Republic Services Approval #, Description of Waste, Volume/Weight, Expiration Date, Container Type. Row 1: 38251011244, Soil for disposal, 31.55 TN, 12-31-2011, Tractor with Dump Trailer(s). Row 2: RZ- #

*Attach Additional Sheet if necessary

I hereby certify that the above-described materials are non-hazardous wastes as defined by 40 CFR 261 or any applicable state law. Further, that the above named materials are properly classified, described, packaged, marked and labeled, and are in proper condition for transportation according to the applicable regulations of the Department of Transportation.

Susan Crowley (Signature) Date Shipped

TRANSPORTER INFORMATION

Transporter Name: Las Vegas Paving

DOT # 191949

Address: 4420 S. Decatur

Truck Number: 220

Las Vegas, NV 89103

Phone Number: (702) 353-4355

I certify no hazardous waste or other regulated substance was knowingly introduced to the waste while in my custody. The waste transported in this vehicle is the waste identified above, to the best of my knowledge.

STEVE TAYLOR (Signature) Date Delivered: 10-6-10

DISPOSAL SITE INFORMATION

Site Name: Apex Regional Landfill

Phone No. (702) 599-5920

Address: 13550 U.S. Hwy 93 Las Vegas, NV

I hereby acknowledge receipt of the above described materials (Signature) Date Received

81 Environmental Tech
13550 N Highway 93
Las Vegas, NV 89165

Ticket Type: INBOUND INVOICE

Ticket Number: 1904
Date: 10/07/2010
Time In: 2:44 am
Time Out: 3:10 am

Customer: 001011 - NGE, LLC c/o Northgate Environ Mgmt

Vehicle/Container: 34330A
Contract: Northgate Env. On Site Soils 3825 11
Comment: 3825 10 11244

Gross Weight: 115,820 LB Manual In
Tare Weight: 55,160 LB Manual Out
Net Weight: 60660 LB
Net Tons: 30.33

BOL: 11997

Origin	Yards	Material	Billing	Quantity
Not Applicable	0.00 YD	SW CONTAMINATED SOIL	30.33	TN

Driver:

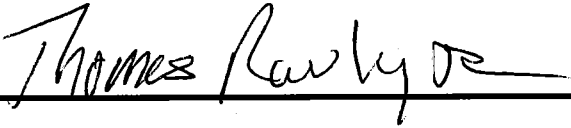

Weighmaster:

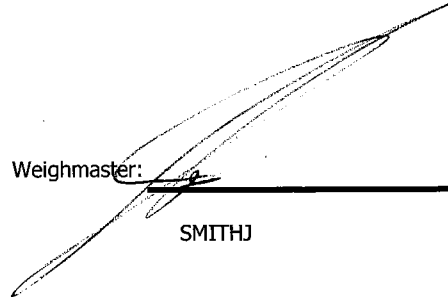

SMITHJ

Indemnification. Customer agrees, by signature above, to indemnify, hold harmless, and defend Republic Services, Inc., its subsidiaries, affiliates, employees, officers and directors from and against any and all liabilities, claims, penalties, forfeitures, suits and the costs and expenses incident thereto, including costs of defense, settlement, and reasonable attorney's fees, which may be incurred, as a result of death or injuries to any person, or damage to any property, contamination of or adverse effects on the environment, caused in whole or in part by the Customer, its employees, or subcontractors in disposing waste at this Facility. In the event Customer delivers Unacceptable Waste (as determined by Republic) Customer agrees to assume all expenses and obligations with the removal and/or resolution of any effects caused by the delivery of such Unacceptable Waste.

Indemnización. Cliente acuerda indemnizar, mantener inmune, y defender Republic Services, Inc., sus subsidiarios, compañías, divisiones, empleados, oficiales y directores contra de cualquiera y de todas responsabilidades, demandas, penas, pérdidas, juicios, pleitos y los costos incidente además, incluyendo costos de defensa, de acuerdo judicial, y de honorarios razonables del abogado, que pueden ser incurridos en, o como resultado de, la muerte o herida personal a cualquier persona, o daños a cualquier característica, propiedad, contaminación de la tierra o efectos ilícitos en esta Facilidad, causado entero o en parte por el cliente, sus empleados, o sus subcontratistas en botar basura en esta Facilidad. En el caso que el Cliente entrega, bota, basura (según lo determinado por Republic) en este Establecimiento basura inaceptable en los reglamentos de este Establecimiento, el Cliente se compromete asumir todos los costos y obligaciones con el retiro y/o la resolución de cualquier dano(s) causado por la entrega de tal basura inaceptable.



NON-HAZARDOUS WASTE MANIFEST

MANIFEST # 11997

GENERATOR INFORMATION

Generator Name: Tronox LLC

Address: P.O. Box 55

City: Henderson County: Clark

State: NV Zip: 89009

Site Location (if different): 560 W. Lake Mead

Henderson, NV 89015 (702) 592-7727

CUSTOMER/BILLING INFORMATION

Billing Name: NGE LLC c/o Northgate Environment Management

Address: 300 Frank Ogawa Plaza, Ste 510

City: Oakland County: Alameda

State: CA Zip: 94612

Table with 5 columns: Republic Services Approval #, Description of Waste, Volume/Weight, Expiration Date, Container Type. Row 1: 38251011244, Soil for disposal, 50 25 TN, 12-31-2011, Tractor with Dump Trailer(s).

*Attach Additional Sheet if necessary

I hereby certify that the above-described materials are non-hazardous wastes as defined by 40 CFR 261 or any applicable state law. Further, that the above named materials are properly classified, described, packaged, marked and labeled, and are in proper condition for transportation according to the applicable regulations of the Department of Transportation.

Susan Crowley Generator/Authorized Agent Name, Tom Crowley Signature, Date Shipped

TRANSPORTER INFORMATION

Transporter Name: Las Vegas Paving

DOT # 191949

Address: 4420 S. Decatur

Truck Number: 981

Las Vegas, NV 89103

Phone Number: (702) 353-4355

I certify no hazardous waste or other regulated substance was knowingly introduced to the waste while in my custody. The waste transported in this vehicle is the waste identified above, to the best of my knowledge.

Tom Kauling Name of Authorized Agent, Thomas Kauling Signature, 10-7-10 Date Delivered

DISPOSAL SITE INFORMATION

Site Name: Apex Regional Landfill

Phone No. (702) 599-5920

Address: 13550 U.S. Hwy 93 Las Vegas, NV

I hereby acknowledge receipt of the above described materials

Name (Print or Type), Signature, Date Received

81 Environmental Tech
13550 N Highway 93
Las Vegas, NV 89165

Ticket Type: INBOUND INVOICE

Ticket Number: 1905
Date: 10/07/2010
Time In: 2:56 am
Time Out: 3:17 am

Customer: 001011 - NGE, LLC c/o Northgate Environ Mgmt

Vehicle/Container: 76811P
Contract: Northgate Env. On Site Soils 3825 11
Comment: 3825 10 11244

Gross Weight: 121,320 LB Manual In
Tare Weight: 53,520 LB Manual Out
Net Weight: 67800 LB
Net Tons: 33.90

BOL: 11998

Origin	Yards	Material	Billing	Quantity
Not Applicable	0.00 YD	SW CONTAMINATED SOIL	33.90	TN

Driver:

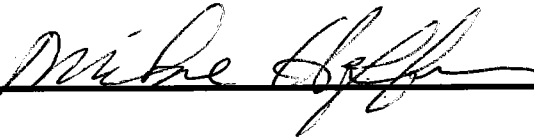

Weighmaster:

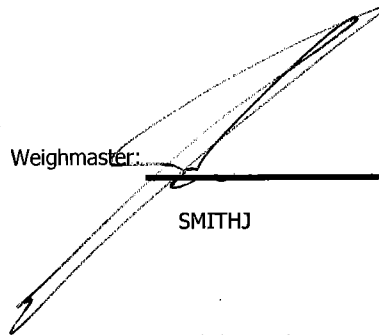

SMITHJ

Indemnification. Customer agrees, by signature above, to indemnify, hold harmless, and defend Republic Services, Inc., its subsidiaries, affiliates, employees, officers and directors from and against any and all liabilities, claims, penalties, forfeitures, suits and the costs and expenses incident thereto, including costs of defense, settlement, and reasonable attorney's fees, which may be incurred, as a result of death or injuries to any person, or damage to any property, contamination of or adverse effects on the environment, caused in whole or in part by the Customer, its employees, or subcontractors in disposing waste at this Facility. In the event Customer delivers Unacceptable Waste (as determined by Republic) Customer agrees to assume all expenses and obligations with the removal and/or resolution of any effects caused by the delivery of such Unacceptable Waste.

Indemnización. Cliente acuerda indemnizar, mantener inmune, y defender Republic Services, Inc., sus subsidiarios, companias, divisiones, empleados, oficiales y directores contra de cualquiera y de todas responsabilidades, demandas, penas, pérdidas, juicios, pleitos y los costos incidente además, incluyendo costos de defensa, de acuerdo judicial, y de honorarios razonables del abogado, que pueden ser incurridos en, o como resultado de, la muerte o herida personal a cualquier persona, o daños a cualquier característica, propiedad, contaminación de la tierra o efectos ilicitos en esta Facilidad, causado entero o en parte por el cliente, sus empleados, o sus subcontratistas en botar basura en esta Facilidad. En el caso que el Cliente entrega, bota, basura (según lo determinado por Republic) en este Establecimiento basura inaceptable en los reglamentos de este Establecimiento, el Cliente se compromete asumir todos los costos y obligaciones con el retiro y/o la resolución de cualquier dano(s) causado por la entrega de tal basura inaceptable.



NON-HAZARDOUS WASTE MANIFEST

MANIFEST # 11998

GENERATOR INFORMATION

Generator Name: Tronox LLC

Address: P.O. Box 55

City: Henderson County: Clark

State: NV Zip: 89009

Site Location (if different): 560 W. Lake Mead

Henderson, NV 89015 (702) 592-7727

CUSTOMER/BILLING INFORMATION

Billing Name: NGE LLC c/o Northgate Environment Management

Address: 300 Frank Ogawa Plaza, Ste 510

City: Oakland County: Alameda

State: CA Zip: 94612

Table with 5 columns: Republic Services Approval #, Description of Waste, Volume/Weight, Expiration Date, Container Type. Row 1: 38251011244, Soil for disposal, 52,90 TN, 12-31-2011, Tractor with Dump Trailer(s).

*Attach Additional Sheet if necessary

I hereby certify that the above-described materials are non-hazardous wastes as defined by 40 CFR 261 or any applicable state law. Further, that the above named materials are properly classified, described, packaged, marked and labeled, and are in proper condition for transportation according to the applicable regulations of the Department of Transportation.

Susan Crowley (Name), [Signature] (Signature), Date Shipped

TRANSPORTER INFORMATION

Transporter Name: Las Vegas Paving

DOT # 191949

Address: 4420 S. Decatur

Truck Number: [Signature]

Las Vegas, NV 89103

Phone Number: (702) 353-4355

I certify no hazardous waste or other regulated substance was knowingly introduced to the waste while in my custody. The waste transported in this vehicle is the waste identified above, to the best of my knowledge.

Mike Heffern (Name), [Signature] (Signature), 10-6-10 (Date Delivered)

DISPOSAL SITE INFORMATION

Site Name: Apex Regional Landfill

Phone No. (702) 599-5920

Address: 13550 U.S. Hwy 93 Las Vegas, NV

I hereby acknowledge receipt of the above described materials

[Signature] (Name (Print or Type)), [Signature] (Signature), Date Received

81 Environmental Tech
13550 N Highway 93
Las Vegas, NV 89165

Ticket Type: INBOUND INVOICE

Ticket Number: 1906
Date: 10/07/2010
Time In: 2:57 am
Time Out: 3:19 am

Customer: 001011 - NGE, LLC c/o Northgate Environ Mgmt

Vehicle/Container: 76810P
Contract: Northgate Env. On Site Soils 3825 11
Comment: 3825 10 11244

Gross Weight: 119,280 LB Manual In
Tare Weight: 56,100 LB Manual Out
Net Weight: 63180 LB
Net Tons: 31.59

BOL: 11996

Origin	Yards	Material	Billing	Quantity
Not Applicable	0.00 YD	SW CONTAMINATED SOIL	31.59	TN

Driver:

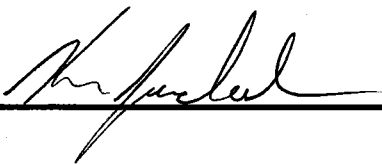

Weighmaster:

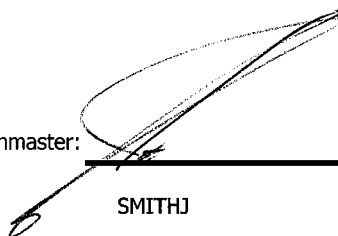
SMITHJ

Indemnification. Customer agrees, by signature above, to indemnify, hold harmless, and defend Republic Services, Inc., its subsidiaries, affiliates, employees, officers and directors from and against any and all liabilities, claims, penalties, forfeitures, suits and the costs and expenses incident thereto, including costs of defense, settlement, and reasonable attorney's fees, which may be incurred, as a result of death or injuries to any person, or damage to any property, contamination of or adverse effects on the environment, caused in whole or in part by the Customer, its employees, or subcontractors in disposing waste at this Facility. In the event Customer delivers Unacceptable Waste (as determined by Republic) Customer agrees to assume all expenses and obligations with the removal and/or resolution of any effects caused by the delivery of such Unacceptable Waste.

Indemnización. Cliente acuerda indemnizar, mantener inmune, y defender Republic Services, Inc., sus subsidiarios, companias, divisiones, empleados, oficiales y directores contra de cualquiera y de todas responsabilidades, demandas, penas, pérdidas, juicios, pleitos y los costos incidente además, incluyendo costos de defensa, de acuerdo judicial, y de honorarios razonables del abogado, que pueden ser incurridos en, o como resultado de, la muerte o herida personal a cualquier persona, o daños a cualquier característica, propiedad, contaminación de la tierra o efectos ilicitos en esta Facilidad, causado entero o en parte por el cliente, sus empleados, o sus subcontratistas en botar basura en esta Facilidad. En el caso que el Cliente entrega, bota, basura (según lo determinado por Republic) en este Establecimiento basura inaceptable en los reglamentos de este Establecimiento, el Cliente se compromete asumir todos los costos y obligaciones con el retiro y/o la resolución de cualquier dano(s) causado por la entrega de tal basura inaceptable.



NON-HAZARDOUS WASTE MANIFEST

MANIFEST # 11996

GENERATOR INFORMATION

Generator Name: Tronox LLC
Address: P.O. Box 55
City: Henderson County: Clark
State: NV Zip: 89009
Site Location (if different): 560 W. Lake Mead
Henderson, NV 89015 (702) 592-7727

CUSTOMER/BILLING INFORMATION

Billing Name: NGE LLC c/o Northgate Environment Management
Address: 300 Frank Ogawa Plaza, Ste 510
City: Oakland County: Alameda
State: CA Zip: 94612

Table with 5 columns: Republic Services Approval #, Description of Waste, Volume/Weight, Expiration Date, Container Type. Row 1: 38251011244, Soil for disposal, 81.5 FTU, 12-31-2011, Tractor with Dump Trailer(s).

*Attach Additional Sheet if necessary

I hereby certify that the above-described materials are non-hazardous wastes as defined by 40 CFR 261 or any applicable state law. Further, that the above named materials are properly classified, described, packaged, marked and labeled, and are in proper condition for transportation according to the applicable regulations of the Department of Transportation.

Susan Crowley (Signature)
Generator/Authorized Agent Name Signature Date Shipped

TRANSPORTER INFORMATION

Transporter Name: Las Vegas Paving DOT # 191949
Address: 4420 S. Decatur Truck Number: 241
Las Vegas, NV 89103 Phone Number: (702) 353-4355

I certify no hazardous waste or other regulated substance was knowingly introduced to the waste while in my custody. The waste transported in this vehicle is the waste identified above, to the best of my knowledge.

Ken Jackson (Signature)
Name of Authorized Agent Signature Date Delivered 10-6-2010

DISPOSAL SITE INFORMATION

Site Name: Apex Regional Landfill Phone No. (702) 599-5920
Address: 13550 U.S. Hwy 93 Las Vegas, NV

I hereby acknowledge receipt of the above described materials
Name (Print or Type) Signature Date Received 10-7-10

81 Environmental Tech
13550 N Highway 93
Las Vegas, NV 89165

Ticket Type: INBOUND INVOICE

Ticket Number: 1907
Date: 10/07/2010
Time In: 3:03 am
Time Out: 3:25 am

Customer: 001011 - NGE, LLC c/o Northgate Environ Mgmt

Vehicle/Container: 44165A
Contract: Northgate Env. On Site Soils 3825 11
Comment: 3825 10 11244

Gross Weight: 127,060 LB Manual In
Tare Weight: 48,620 LB Manual Out
Net Weight: 78440 LB
Net Tons: 39.22

BOL: 12000

Origin	Yards	Material	Billing Quantity
Not Applicable	0.00 YD	SW CONTAMINATED SOIL	39.22 TN

Driver: _____

CEB O

Weighmaster: _____

[Signature]
SMITHJ

Indemnification. Customer agrees, by signature above, to indemnify, hold harmless, and defend Republic Services, Inc., its subsidiaries, affiliates, employees, officers and directors from and against any and all liabilities, claims, penalties, forfeitures, suits and the costs and expenses incident thereto, including costs of defense, settlement, and reasonable attorney's fees, which may be incurred, as a result of death or injuries to any person, or damage to any property, contamination of or adverse effects on the environment, caused in whole or in part by the Customer, its employees, or subcontractors in disposing waste at this Facility. In the event Customer delivers Unacceptable Waste (as determined by Republic) Customer agrees to assume all expenses and obligations with the removal and/or resolution of any effects caused by the delivery of such Unacceptable Waste.

Indemnización. Cliente acuerda indemnizar, mantener inmune, y defender Republic Services, Inc., sus subsidiarios, compañías, divisiones, empleados, oficiales y directores contra de cualquiera y de todas responsabilidades, demandas, penas, pérdidas, juicios, pleitos y los costos incidente además, incluyendo costos de defensa, de acuerdo judicial, y de honorarios razonables del abogado, que pueden ser incurridos en, o como resultado de, la muerte o herida personal a cualquier persona, o daños a cualquier característica, propiedad, contaminación de la tierra o efectos ilícitos en esta Facilidad, causado entero o en parte por el cliente, sus empleados, o sus subcontratistas en botar basura en esta Facilidad. En el caso que el Cliente entrega, bota, basura (según lo determinado por Republic) en este Establecimiento basura inaceptable en los reglamentos de este Establecimiento, el Cliente se compromete asumir todos los costos y obligaciones con el retiro y/o la resolución de cualquier dano(s) causado por la entrega de tal basura inaceptable.



NON-HAZARDOUS WASTE MANIFEST

MANIFEST # 12000

GENERATOR INFORMATION

Generator Name: Tronox LLC
Address: P.O. Box 55
City: Henderson County: Clark
State: NV Zip: 89009
Site Location (if different): 560 W. Lake Mead
Henderson, NV 89015 (702) 592-7727

CUSTOMER/BILLING INFORMATION

Billing Name: NGE LLC c/o Northgate Environment Management
Address: 300 Frank Ogawa Plaza, Ste 510
City: Oakland County: Alameda
State: CA Zip: 94612

Table with 5 columns: Republic Services Approval #, Description of Waste, Volume/Weight, Expiration Date, Container Type. Row 1: 38251011244, Soil for disposal, Stock in, 12-31-2011, Tractor with Dump Trailer(s). Row 2: RZ- #

*Attach Additional Sheet if necessary

I hereby certify that the above-described materials are non-hazardous wastes as defined by 40 CFR 261 or any applicable state law. Further, that the above named materials are properly classified, described, packaged, marked and labeled, and are in proper condition for transportation according to the applicable regulations of the Department of Transportation.

Susan Crowley
Generator/Authorized Agent Name Signature Date Shipped

TRANSPORTER INFORMATION

Transporter Name: Las Vegas Paving DOT # 191949
Address: 4420 S. Decatur Truck Number: K001
Las Vegas, NV 89103 Phone Number: (702) 353-4355

I certify no hazardous waste or other regulated substance was knowingly introduced to the waste while in my custody. The waste transported in this vehicle is the waste identified above, to the best of my knowledge.

CEBU CEBU 10/06/10
Name of Authorized Agent Signature Date Delivered

DISPOSAL SITE INFORMATION

Site Name: Apex Regional Landfill Phone No. (702) 599-5920
Address: 13550 U.S. Hwy 93 Las Vegas, NV

I hereby acknowledge receipt of the above described materials
Name (Print or Type) Signature Date Received

81 Environmental Tech
13550 N Highway 93
Las Vegas, NV 89165

Ticket Type: INBOUND INVOICE

Ticket Number: 1908
Date: 10/07/2010
Time In: 3:13 am
Time Out: 3:36 am

Customer: 001011 - NGE, LLC c/o Northgate Environ Mgmt

Vehicle/Container: 68263P
Contract: Northgate Env. On Site Soils 3825 11
Comment: 3825 10 11244

Gross Weight: 118,660 LB Manual In
Tare Weight: 53,760 LB Manual Out
Net Weight: 64900 LB
Net Tons: 32.45

BOL: 19999

Origin	Yards	Material	Billing Quantity
Not Applicable	0.00 YD	SW CONTAMINATED SOIL	32.45 TN

Driver: _____



Weighmaster: _____

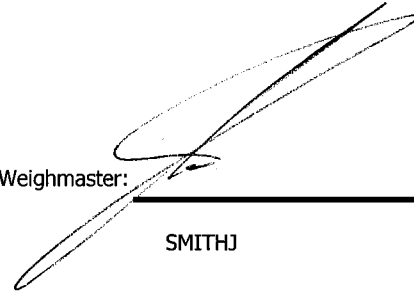

SMITHJ

Indemnification. Customer agrees, by signature above, to indemnify, hold harmless, and defend Republic Services, Inc., its subsidiaries, affiliates, employees, officers and directors from and against any and all liabilities, claims, penalties, forfeitures, suits and the costs and expenses incident thereto, including costs of defense, settlement, and reasonable attorney's fees, which may be incurred, as a result of death or injuries to any person, or damage to any property, contamination of or adverse effects on the environment, caused in whole or in part by the Customer, its employees, or subcontractors in disposing waste at this Facility. In the event Customer delivers Unacceptable Waste (as determined by Republic) Customer agrees to assume all expenses and obligations with the removal and/or resolution of any effects caused by the delivery of such Unacceptable Waste.

Indemnización. Cliente acuerda indemnizar, mantener inmune, y defender Republic Services, Inc., sus subsidiarios, compañías, divisiones, empleados, oficiales y directores contra de cualquiera y de todas responsabilidades, demandas, penas, pérdidas, juicios, pleitos y los costos incidente además, incluyendo costos de defensa, de acuerdo judicial, y de honorarios razonables del abogado, que pueden ser incurridos en, o como resultado de, la muerte o herida personal a cualquier persona, o daños a cualquier característica, propiedad, contaminación de la tierra o efectos ilícitos en esta Facilidad, causado entero o en parte por el cliente, sus empleados, o sus subcontratistas en botar basura en esta Facilidad. En el caso que el Cliente entrega, bota, basura (según lo determinado por Republic) en este Establecimiento basura inaceptable en los reglamentos de este Establecimiento, el Cliente se compromete asumir todos los costos y obligaciones con el retiro y/o la resolución de cualquier dano(s) causado por la entrega de tal basura inaceptable.



NON-HAZARDOUS WASTE MANIFEST

MANIFEST # 11999

GENERATOR INFORMATION

Generator Name: Tronox LLC
Address: P.O. Box 55
City: Henderson County: Clark
State: NV Zip: 89009
Site Location (if different): 560 W. Lake Mead
Henderson, NV 89015 (702) 592-7727

CUSTOMER/BILLING INFORMATION

Billing Name: NGE LLC c/o Northgate Environment Management
Address: 300 Frank Ogawa Plaza, Ste 510
City: Oakland County: Alameda
State: CA Zip: 94612

Table with 5 columns: Republic Services Approval #, Description of Waste, Volume/Weight, Expiration Date, Container Type. Row 1: 38251011244, Soil for disposal, 32.45 TN, 12-31-2011, Tractor with Dump Trailer(s).

*Attach Additional Sheet if necessary

I hereby certify that the above-described materials are non-hazardous wastes as defined by 40 CFR 261 or any applicable state law. Further, that the above named materials are properly classified, described, packaged, marked and labeled, and are in proper condition for transportation according to the applicable regulations of the Department of Transportation.

Susan Crowley
Generator/Authorized Agent Name Signature Date Shipped

TRANSPORTER INFORMATION

Transporter Name: Las Vegas Paving DOT # 191949
Address: 4420 S. Decatur Truck Number: 2711
Las Vegas, NV 89103 Phone Number: (702) 353-4355

I certify no hazardous waste or other regulated substance was knowingly introduced to the waste while in my custody. The waste transported in this vehicle is the waste identified above, to the best of my knowledge.

STEVE HAYES
Name of Authorized Agent Signature Date Delivered

DISPOSAL SITE INFORMATION

Site Name: Apex Regional Landfill Phone No. (702) 599-5920
Address: 13550 U.S. Hwy 93 Las Vegas, NV

I hereby acknowledge receipt of the above described materials
Name (Print or Type) Signature Date Received

81 Environmental Tech
13550 N Highway 93
Las Vegas, NV 89165

Ticket Type: INBOUND INVOICE

Ticket Number: 1909
Date: 10/07/2010
Time In: 3:22 am
Time Out: 3:52 am

Customer: 001011 - NGE, LLC c/o Northgate Environ Mgmt

Vehicle/Container: 43073A
Contract: Northgate Env. On Site Soils 3825 11
Comment: 3825 10 11244

Gross Weight: 117,620 LB Manual In
Tare Weight: 57,580 LB Manual Out
Net Weight: 60040 LB
Net Tons: 30.02

BOL: 12001

Origin	Yards	Material	Billing	Quantity
Not Applicable	0.00 YD	SW CONTAMINATED SOIL	30.02	TN

Driver: _____

Weighmaster: _____

SMITHJ

Indemnification. Customer agrees, by signature above, to indemnify, hold harmless, and defend Republic Services, Inc., its subsidiaries, affiliates, employees, officers and directors from and against any and all liabilities, claims, penalties, forfeitures, suits and the costs and expenses incident thereto, including costs of defense, settlement, and reasonable attorney's fees, which may be incurred, as a result of death or injuries to any person, or damage to any property, contamination of or adverse effects on the environment, caused in whole or in part by the Customer, its employees, or subcontractors in disposing waste at this Facility. In the event Customer delivers Unacceptable Waste (as determined by Republic) Customer agrees to assume all expenses and obligations with the removal and/or resolution of any effects caused by the delivery of such Unacceptable Waste.

Indemnización. Cliente acuerda indemnizar, mantener inmune, y defender Republic Services, Inc., sus subsidiarios, compañías, divisiones, empleados, oficiales y directores contra de cualquiera y de todas responsabilidades, demandas, penas, pérdidas, juicios, pleitos y los costos incidente además, incluyendo costos de defensa, de acuerdo judicial, y de honorarios razonables del abogado, que pueden ser incurridos en, o como resultado de, la muerte o herida personal a cualquier persona, o daños a cualquier característica, propiedad, contaminación de la tierra o efectos ilícitos en esta Facilidad, causado entero o en parte por el cliente, sus empleados, o sus subcontratistas en botar basura en esta Facilidad. En el caso que el Cliente entrega, bota, basura (según lo determinado por Republic) en este Establecimiento basura inaceptable en los reglamentos de este Establecimiento, el Cliente se compromete asumir todos los costos y obligaciones con el retiro y/o la resolución de cualquier dano(s) causado por la entrega de tal basura inaceptable.



NON-HAZARDOUS WASTE MANIFEST

MANIFEST # 12001

GENERATOR INFORMATION

Generator Name: Tronox LLC

Address: P.O. Box 55

City: Henderson County: Clark

State: NV Zip: 89009

Site Location (if different): 560 W. Lake Mead

Henderson, NV 89015 (702) 592-7727

CUSTOMER/BILLING INFORMATION

Billing Name: NGE LLC c/o Northgate Environment Management

Address: 300 Frank Ogawa Plaza, Ste 510

City: Oakland County: Alameda

State: CA Zip: 94612

Republic Services Approval #	Description of Waste	Volume/Weight	Expiration Date	Container Type
38251011244	Soil for disposal		12-31-2011	Tractor with Dump Trailer(s)
	RZ- #	2002 lb		

*Attach Additional Sheet if necessary

I hereby certify that the above-described materials are non-hazardous wastes as defined by 40 CFR 261 or any applicable state law. Further, that the above named materials are properly classified, described, packaged, marked and labeled, and are in proper condition for transportation according to the applicable regulations of the Department of Transportation.

Susan Crowley

Susan Crowley

Generator/Authorized Agent Name

Signature

Date Shipped

TRANSPORTER INFORMATION

Transporter Name: Las Vegas Paving

DOT # 191949

Address: 4420 S. Decatur

Truck Number: 89

Las Vegas, NV 89103

Phone Number: (702) 353-4355

I certify no hazardous waste or other regulated substance was knowingly introduced to the waste while in my custody. The waste transported in this vehicle is the waste identified above, to the best of my knowledge.

Brad Thomas

[Signature]

Name of Authorized Agent

Signature

Date Delivered

DISPOSAL SITE INFORMATION

Site Name: Apex Regional Landfill

Phone No. (702) 599-5920

Address: 13550 U.S. Hwy 93 Las Vegas, NV

I hereby acknowledge receipt of the above described materials

[Signature]

[Signature]

[Signature]

Name (Print or Type)

Signature

Date Received

81 Environmental Tech
13550 N Highway 93
Las Vegas, NV 89165

Ticket Type: INBOUND INVOICE

Ticket Number: 1910
Date: 10/07/2010
Time In: 3:31 am
Time Out: 3:59 am

Customer: 001011 - NGE, LLC c/o Northgate Environ Mgmt

Vehicle/Container: 44564A
Contract: Northgate Env. On Site Soils 3825 11
Comment: 3825 10 11244

Gross Weight: 129,260 LB Manual In
Tare Weight: 49,320 LB Manual Out
Net Weight: 79940 LB
Net Tons: 39.97

BOL: 12002

Origin	Yards	Material	Billing	Quantity
Not Applicable	0.00 YD	SW CONTAMINATED SOIL	39.97	TN

Driver: _____

Weighmaster: _____

SMITHJ

Indemnification. Customer agrees, by signature above, to indemnify, hold harmless, and defend Republic Services, Inc., its subsidiaries, affiliates, employees, officers and directors from and against any and all liabilities, claims, penalties, forfeitures, suits and the costs and expenses incident thereto, including costs of defense, settlement, and reasonable attorney's fees, which may be incurred, as a result of death or injuries to any person, or damage to any property, contamination of or adverse effects on the environment, caused in whole or in part by the Customer, its employees, or subcontractors in disposing waste at this Facility. In the event Customer delivers Unacceptable Waste (as determined by Republic) Customer agrees to assume all expenses and obligations with the removal and/or resolution of any effects caused by the delivery of such Unacceptable Waste.

Indemnización. Cliente acuerda indemnizar, mantener inmune, y defender Republic Services, Inc., sus subsidiarios, compañías, divisiones, empleados, oficiales y directores contra de cualquiera y de todas responsabilidades, demandas, penas, pérdidas, juicios, pleitos y los costos incidente además, incluyendo costos de defensa, de acuerdo judicial, y de honorarios razonables del abogado, que pueden ser incurridos en, o como resultado de, la muerte o herida personal a cualquier persona, o daños a cualquier característica, propiedad, contaminación de la tierra o efectos ilícitos en esta Facilidad, causado entero o en parte por el cliente, sus empleados, o sus subcontratistas en botar basura en esta Facilidad. En el caso que el Cliente entrega, bota, basura (según lo determinado por Republic) en este Establecimiento basura inaceptable en los reglamentos de este Establecimiento, el Cliente se compromete asumir todos los costos y obligaciones con el retiro y/o la resolución de cualquier dano(s) causado por la entrega de tal basura inaceptable.



NON-HAZARDOUS WASTE MANIFEST

MANIFEST # 12002

GENERATOR INFORMATION

Generator Name: Tronox LLC

Address: P.O. Box 55

City: Henderson County: Clark

State: NV Zip: 89009

Site Location (if different): 560 W. Lake Mead

Henderson, NV 89015 (702) 592-7727

CUSTOMER/BILLING INFORMATION

Billing Name: NGE LLC c/o Northgate Environment Management

Address: 300 Frank Ogawa Plaza, Ste 510

City: Oakland County: Alameda

State: CA Zip: 94612

Republic Services Approval #	Description of Waste	Volume/Weight	Expiration Date	Container Type
38251011244	Soil for disposal		12-31-2011	Tractor with Dump Trailer(s)
	RZ- _____ # _____	37.97 TON		

*Attach Additional Sheet if necessary

I hereby certify that the above-described materials are non-hazardous wastes as defined by 40 CFR 261 or any applicable state law. Further, that the above named materials are properly classified, described, packaged, marked and labeled, and are in proper condition for transportation according to the applicable regulations of the Department of Transportation.

Susan Crowley

Susan Crowley

Generator/Authorized Agent Name

Signature

Date Shipped

TRANSPORTER INFORMATION

Transporter Name: Las Vegas Paving

DOT # 191949

Address: 4420 S. Decatur

Truck Number: K003

Las Vegas, NV 89103

Phone Number: (702) 353-4355

I certify no hazardous waste or other regulated substance was knowingly introduced to the waste while in my custody. The waste transported in this vehicle is the waste identified above, to the best of my knowledge.

[Signature]

A. Sencior

10/6/10

Name of Authorized Agent

Signature

Date Delivered

DISPOSAL SITE INFORMATION

Site Name: Apex Regional Landfill

Phone No. (702) 599-5920

Address: 13550 U.S. Hwy 93 Las Vegas, NV

I hereby acknowledge receipt of the above described materials

JASON SMITH

[Signature]

10-7-10

Name (Print or Type)

Signature

Date Received

81 Environmental Tech
13550 N Highway 93
Las Vegas, NV 89165

Ticket Type: INBOUND INVOICE

Ticket Number: 1911
Date: 10/07/2010
Time In: 3:42 am
Time Out: 4:10 am

Customer: 001011 - NGE, LLC c/o Northgate Environ Mgmt

Vehicle/Container: 86113P
Contract: Northgate Env. On Site Soils 3825 11
Comment: 3825 10 11244

Gross Weight: 137,580 LB Manual In
Tare Weight: 55,240 LB Manual Out
Net Weight: 82340 LB
Net Tons: 41.17

BOL: 12003

Origin	Yards	Material	Billing	Quantity
Not Applicable	0.00 YD	SW CONTAMINATED SOIL	41.17	TN

Driver: _____

J. A. H.

Weighmaster: _____

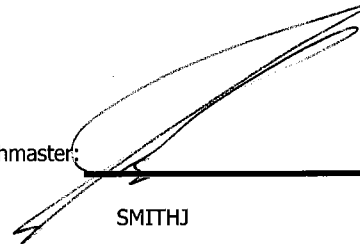
SMITHJ

Indemnification. Customer agrees, by signature above, to indemnify, hold harmless, and defend Republic Services, Inc., its subsidiaries, affiliates, employees, officers and directors from and against any and all liabilities, claims, penalties, forfeitures, suits and the costs and expenses incident thereto, including costs of defense, settlement, and reasonable attorney's fees, which may be incurred, as a result of death or injuries to any person, or damage to any property, contamination of or adverse effects on the environment, caused in whole or in part by the Customer, its employees, or subcontractors in disposing waste at this Facility. In the event Customer delivers Unacceptable Waste (as determined by Republic) Customer agrees to assume all expenses and obligations with the removal and/or resolution of any effects caused by the delivery of such Unacceptable Waste.

Indemnización. Cliente acuerda indemnizar, mantener inmune, y defender Republic Services, Inc., sus subsidiarios, compañías, divisiones, empleados, oficiales y directores contra de cualquiera y de todas responsabilidades, demandas, penas, pérdidas, juicios, pleitos y los costos incidente además, incluyendo costos de defensa, de acuerdo judicial, y de honorarios razonables del abogado, que pueden ser incurridos en, o como resultado de, la muerte o herida personal a cualquier persona, o daños a cualquier característica, propiedad, contaminación de la tierra o efectos ilícitos en esta Facilidad, causado entero o en parte por el cliente, sus empleados, o sus subcontratistas en botar basura en esta Facilidad. En el caso que el Cliente entrega, bota, basura (según lo determinado por Republic) en este Establecimiento basura inaceptable en los reglamentos de este Establecimiento, el Cliente se compromete asumir todos los costos y obligaciones con el retiro y/o la resolución de cualquier dano(s) causado por la entrega de tal basura inaceptable.



NON-HAZARDOUS WASTE MANIFEST

MANIFEST # 12003

GENERATOR INFORMATION

Generator Name: Tronox LLC
Address: P.O. Box 55
City: Henderson County: Clark
State: NV Zip: 89009
Site Location (if different): 560 W. Lake Mead
Henderson, NV 89015 (702) 592-7727

CUSTOMER/BILLING INFORMATION

Billing Name: NGE LLC c/o Northgate Environment Management
Address: 300 Frank Ogawa Plaza, Ste 510
City: Oakland County: Alameda
State: CA Zip: 94612

Table with 5 columns: Republic Services Approval #, Description of Waste, Volume/Weight, Expiration Date, Container Type. Row 1: 38251011244, Soil for disposal, 41.770, 12-31-2011, Tractor with Dump Trailer(s).

*Attach Additional Sheet if necessary

I hereby certify that the above-described materials are non-hazardous wastes as defined by 40 CFR 261 or any applicable state law. Further, that the above named materials are properly classified, described, packaged, marked and labeled, and are in proper condition for transportation according to the applicable regulations of the Department of Transportation.

Susan Crowley (Signature)
Generator/Authorized Agent Name Signature Date Shipped

TRANSPORTER INFORMATION

Transporter Name: Las Vegas Paving DOT # 191949
Address: 4420 S. Decatur Truck Number: 120019/7
Las Vegas, NV 89103 Phone Number: (702) 353-4355

I certify no hazardous waste or other regulated substance was knowingly introduced to the waste while in my custody. The waste transported in this vehicle is the waste identified above, to the best of my knowledge.

ALBERTO (Signature)
Name of Authorized Agent Signature Date Delivered Oct 6, 2010

DISPOSAL SITE INFORMATION

Site Name: Apex Regional Landfill Phone No. (702) 599-5920
Address: 13550 U.S. Hwy 93 Las Vegas, NV

I hereby acknowledge receipt of the above described materials

(Signature)
Name (Print or Type) Signature Date Received

81 Environmental Tech
13550 N Highway 93
Las Vegas, NV 89165

Ticket Type: INBOUND INVOICE

Ticket Number: 1912
Date: 10/07/2010
Time In: 4:01 am
Time Out: 4:25 am

Customer: 001011 - NGE, LLC c/o Northgate Environ Mgmt

Vehicle/Container: 85887P
Contract: Northgate Env. On Site Soils 3825 11
Comment: 3825 10 11244

Gross Weight: 134,460 LB Manual In
Tare Weight: 50,940 LB Manual Out
Net Weight: 83520 LB
Net Tons: 41.76

BOL: 12004

Origin	Yards	Material	Billing Quantity
Not Applicable	0.00 YD	SW CONTAMINATED SOIL	41.76 TN

Driver:

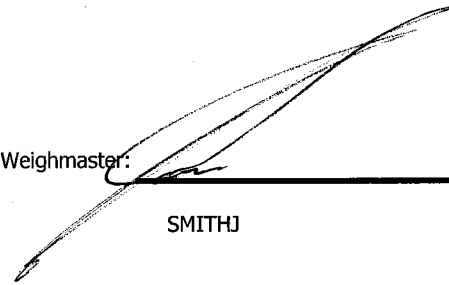

Weighmaster:

SMITHJ

Indemnification. Customer agrees, by signature above, to indemnify, hold harmless, and defend Republic Services, Inc., its subsidiaries, affiliates, employees, officers and directors from and against any and all liabilities, claims, penalties, forfeitures, suits and the costs and expenses incident thereto, including costs of defense, settlement, and reasonable attorney's fees, which may be incurred, as a result of death or injuries to any person, or damage to any property, contamination of or adverse effects on the environment, caused in whole or in part by the Customer, its employees, or subcontractors in disposing waste at this Facility. In the event Customer delivers Unacceptable Waste (as determined by Republic) Customer agrees to assume all expenses and obligations with the removal and/or resolution of any effects caused by the delivery of such Unacceptable Waste.

Indemnización. Cliente acuerda indemnizar, mantener inmune, y defender Republic Services, Inc., sus subsidiarios, compañías, divisiones, empleados, oficiales y directores contra de cualquiera y de todas responsabilidades, demandas, penas, pérdidas, juicios, pleitos y los costos incidente además, incluyendo costos de defensa, de acuerdo judicial, y de honorarios razonables del abogado, que pueden ser incurridos en, o como resultado de, la muerte o herida personal a cualquier persona, o daños a cualquier característica, propiedad, contaminación de la tierra o efectos ilícitos en esta Facilidad, causado entero o en parte por el cliente, sus empleados, o sus subcontratistas en botar basura en esta Facilidad. En el caso que el Cliente entrega, bota, basura (según lo determinado por Republic) en este Establecimiento basura inaceptable en los reglamentos de este Establecimiento, el Cliente se compromete asumir todos los costos y obligaciones con el retiro y/o la resolución de cualquier dano(s) causado por la entrega de tal basura inaceptable.



NON-HAZARDOUS WASTE MANIFEST

MANIFEST # 12004

GENERATOR INFORMATION

Generator Name: Tronox LLC

Address: P.O. Box 55

City: Henderson County: Clark

State: NV Zip: 89009

Site Location (if different): 560 W. Lake Mead

Henderson, NV 89015 (702) 592-7727

CUSTOMER/BILLING INFORMATION

Billing Name: NGE LLC c/o Northgate Environment Management

Address: 300 Frank Ogawa Plaza, Ste 510

City: Oakland County: Alameda

State: CA Zip: 94612

Republic Services Approval #	Description of Waste	Volume/Weight	Expiration Date	Container Type
38251011244	Soil for disposal		12-31-2011	Tractor with Dump Trailer(s)
	RZ-_____ # _____	41 - 2 TR		

*Attach Additional Sheet if necessary

I hereby certify that the above-described materials are non-hazardous wastes as defined by 40 CFR 261 or any applicable state law. Further, that the above named materials are properly classified, described, packaged, marked and labeled, and are in proper condition for transportation according to the applicable regulations of the Department of Transportation.

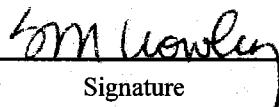
Susan Crowley 
 Generator/Authorized Agent Name Signature Date Shipped

TRANSPORTER INFORMATION

Transporter Name: Las Vegas Paving

DOT # 191949

Address: 4420 S. Decatur

Truck Number: RO1

Las Vegas, NV 89103

Phone Number: (702) 353-4355

I certify no hazardous waste or other regulated substance was knowingly introduced to the waste while in my custody. The waste transported in this vehicle is the waste identified above, to the best of my knowledge.

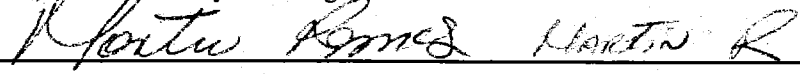
North James Martin 10/6/10
 Name of Authorized Agent Signature Date Delivered

DISPOSAL SITE INFORMATION

Site Name: Apex Regional Landfill

Phone No. (702) 599-5920

Address: 13550 U.S. Hwy 93 Las Vegas, NV

I hereby acknowledge receipt of the above described materials

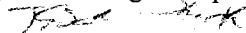
_____ _____ _____
 Name (Print or Type) Signature Date Received

81 Environmental Tech
13550 N Highway 93
Las Vegas, NV 89165

Ticket Type: INBOUND INVOICE

Ticket Number: 1913
Date: 10/07/2010
Time In: 4:00 am
Time Out: 4:31 am

Customer: 001011 - NGE, LLC c/o Northgate Environ Mgmt

Vehicle/Container: 192457
Contract: Northgate Env. On Site Soils 3825 11
Comment: 3825 10 11244

Gross Weight: 125,920 LB Manual In
Tare Weight: 52,420 LB Manual Out
Net Weight: 73500 LB
Net Tons: 36.75

BOL: 12005

Origin	Yards	Material	Billing Quantity
Not Applicable	0.00 YD	SW CONTAMINATED SOIL	36.75 TN

Driver:

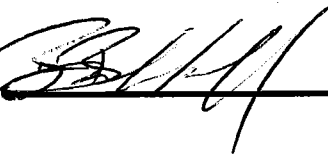

Weighmaster:

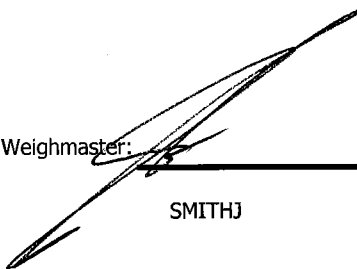

SMITHJ

Indemnification. Customer agrees, by signature above, to indemnify, hold harmless, and defend Republic Services, Inc., its subsidiaries, affiliates, employees, officers and directors from and against any and all liabilities, claims, penalties, forfeitures, suits and the costs and expenses incident thereto, including costs of defense, settlement, and reasonable attorney's fees, which may be incurred, as a result of death or injuries to any person, or damage to any property, contamination of or adverse effects on the environment, caused in whole or in part by the Customer, its employees, or subcontractors in disposing waste at this Facility. In the event Customer delivers Unacceptable Waste (as determined by Republic) Customer agrees to assume all expenses and obligations with the removal and/or resolution of any effects caused by the delivery of such Unacceptable Waste.

Indemnización. Cliente acuerda indemnizar, mantener inmune, y defender Republic Services, Inc., sus subsidiarios, compañías, divisiones, empleados, oficiales y directores contra de cualquiera y de todas responsabilidades, demandas, penas, pérdidas, juicios, pleitos y los costos incidente además, incluyendo costos de defensa, de acuerdo judicial, y de honorarios razonables del abogado, que pueden ser incurridos en, o como resultado de, la muerte o herida personal a cualquier persona, o daños a cualquier característica, propiedad, contaminación de la tierra o efectos ilícitos en esta Facilidad, causado entero o en parte por el cliente, sus empleados, o sus subcontratistas en botar basura en esta Facilidad. En el caso que el Cliente entrega, bota, basura (según lo determinado por Republic) en este Establecimiento basura inaceptable en los reglamentos de este Establecimiento, el Cliente se compromete asumir todos los costos y obligaciones con el retiro y/o la resolución de cualquier dano(s) causado por la entrega de tal basura inaceptable.



NON-HAZARDOUS WASTE MANIFEST

MANIFEST # 12005

GENERATOR INFORMATION

Generator Name: Tronox LLC
Address: P.O. Box 55
City: Henderson County: Clark
State: NV Zip: 89009
Site Location (if different): 560 W. Lake Mead
Henderson, NV 89015 (702) 592-7727

CUSTOMER/BILLING INFORMATION

Billing Name: NGE LLC c/o Northgate Environment Management
Address: 300 Frank Ogawa Plaza, Ste 510
City: Oakland County: Alameda
State: CA Zip: 94612

Table with 5 columns: Republic Services Approval #, Description of Waste, Volume/Weight, Expiration Date, Container Type. Row 1: 38251011244, Soil for disposal, 7.75 70, 12-31-2011, Tractor with Dump Trailer(s).

*Attach Additional Sheet if necessary

I hereby certify that the above-described materials are non-hazardous wastes as defined by 40 CFR 261 or any applicable state law. Further, that the above named materials are properly classified, described, packaged, marked and labeled, and are in proper condition for transportation according to the applicable regulations of the Department of Transportation.

Susan Crowley
Generator/Authorized Agent Name Signature Date Shipped

TRANSPORTER INFORMATION

Transporter Name: Las Vegas Paving DOT # 191949
Address: 4420 S. Decatur Truck Number: 192457
Las Vegas, NV 89103 Phone Number: (702) 353-4355

I certify no hazardous waste or other regulated substance was knowingly introduced to the waste while in my custody. The waste transported in this vehicle is the waste identified above, to the best of my knowledge.

Brian Brunkerhoff
Name of Authorized Agent Signature Date Delivered 10-6-10

DISPOSAL SITE INFORMATION

Site Name: Apex Regional Landfill Phone No. (702) 599-5920
Address: 13550 U.S. Hwy 93 Las Vegas, NV

I hereby acknowledge receipt of the above described materials
Name (Print or Type) Signature Date Received

81 Environmental Tech
13550 N Highway 93
Las Vegas, NV 89165

Ticket Type: INBOUND INVOICE

Ticket Number: 1914
Date: 10/07/2010
Time In: 4:11 am
Time Out: 4:36 am

Customer: 001011 - NGE, LLC c/o Northgate Environ Mgmt

Vehicle/Container: 192460
Contract: Northgate Env. On Site Soils 3825 11
Comment: 3825 10 11244

Gross Weight: 126,900 LB Manual In
Tare Weight: 53,280 LB Manual Out
Net Weight: 73620 LB
Net Tons: 36.81

BOL: 12008

Origin	Yards	Material	Billing Quantity
Not Applicable	0.00 YD	SW CONTAMINATED SOIL	36.81 TN

Driver:

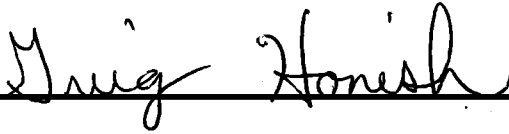

Weighmaster:

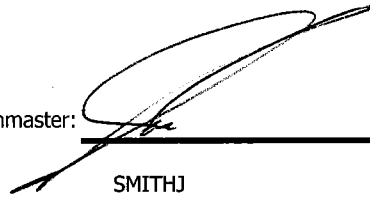
SMITHJ

Indemnification. Customer agrees, by signature above, to indemnify, hold harmless, and defend Republic Services, Inc., its subsidiaries, affiliates, employees, officers and directors from and against any and all liabilities, claims, penalties, forfeitures, suits and the costs and expenses incident thereto, including costs of defense, settlement, and reasonable attorney's fees, which may be incurred, as a result of death or injuries to any person, or damage to any property, contamination of or adverse effects on the environment, caused in whole or in part by the Customer, its employees, or subcontractors in disposing waste at this Facility. In the event Customer delivers Unacceptable Waste (as determined by Republic) Customer agrees to assume all expenses and obligations with the removal and/or resolution of any effects caused by the delivery of such Unacceptable Waste.

Indemnización. Cliente acuerda indemnizar, mantener inmune, y defender Republic Services, Inc., sus subsidiarios, companias, divisiones, empleados, oficiales y directores contra de cualquiera y de todas responsabilidades, demandas, penas, pérdidas, juicios, pleitos y los costos incidente además, incluyendo costos de defensa, de acuerdo judicial, y de honorarios razonables del abogado, que pueden ser incurridos en, o como resultado de, la muerte o herida personal a cualquier persona, o daños a cualquier característica, propiedad, contaminación de la tierra o efectos ilicitos en esta Facilidad, causado entero o en parte por el cliente, sus empleados, o sus subcontratistas en botar basura en esta Facilidad. En el caso que el Cliente entrega, bota, basura (según lo determinado por Republic) en este Establecimiento basura inaceptable en los reglamentos de este Establecimiento, el Cliente se compromete asumir todos los costos y obligaciones con el retiro y/o la resolución de cualquier dano(s) causado por la entrega de tal basura inaceptable.



NON-HAZARDOUS WASTE MANIFEST

MANIFEST # 12008

GENERATOR INFORMATION

Generator Name: Tronox LLC
Address: P.O. Box 55
City: Henderson County: Clark
State: NV Zip: 89009
Site Location (if different): 560 W. Lake Mead
Henderson, NV 89015 (702) 592-7727

CUSTOMER/BILLING INFORMATION

Billing Name: NGE LLC c/o Northgate Environment Management
Address: 300 Frank Ogawa Plaza, Ste 510
City: Oakland County: Alameda
State: CA Zip: 94612

Table with 5 columns: Republic Services Approval #, Description of Waste, Volume/Weight, Expiration Date, Container Type. Row 1: 38251011244, Soil for disposal, 2.81 TU, 12-31-2011, Tractor with Dump Trailer(s).

*Attach Additional Sheet if necessary

I hereby certify that the above-described materials are non-hazardous wastes as defined by 40 CFR 261 or any applicable state law. Further, that the above named materials are properly classified, described, packaged, marked and labeled, and are in proper condition for transportation according to the applicable regulations of the Department of Transportation.

Susan Crowley (Signature)
Generator/Authorized Agent Name Signature Date Shipped

TRANSPORTER INFORMATION

Transporter Name: Las Vegas Paving DOT # 191949
Address: 4420 S. Decatur Truck Number: 2460
Las Vegas, NV 89103 Phone Number: (702) 353-4355

I certify no hazardous waste or other regulated substance was knowingly introduced to the waste while in my custody. The waste transported in this vehicle is the waste identified above, to the best of my knowledge.

Graig Howish (Signature) Date Delivered: 10-6-10
Name of Authorized Agent Signature Date Delivered

DISPOSAL SITE INFORMATION

Site Name: Apex Regional Landfill Phone No. (702) 599-5920
Address: 13550 U.S. Hwy 93 Las Vegas, NV

I hereby acknowledge receipt of the above described materials.
Name (Print or Type) Signature Date Received: 10-7-10

81 Environmental Tech
13550 N Highway 93
Las Vegas, NV 89165

Ticket Type: INBOUND INVOICE

Ticket Number: 1915
Date: 10/07/2010
Time In: 4:14 am
Time Out: 4:43 am

Customer: 001011 - NGE, LLC c/o Northgate Environ Mgmt

Vehicle/Container: 44166A
Contract: Northgate Env. On Site Soils 3825 11
Comment: 3825 10 11244

Gross Weight: 134,560 LB Manual In
Tare Weight: 57,060 LB Manual Out
Net Weight: 77500 LB
Net Tons: 38.75

BOL: 12007

Origin	Yards	Material	Billing Quantity
Not Applicable	0.00 YD	SW CONTAMINATED SOIL	38.75 TN

Driver: _____



Weighmaster: _____

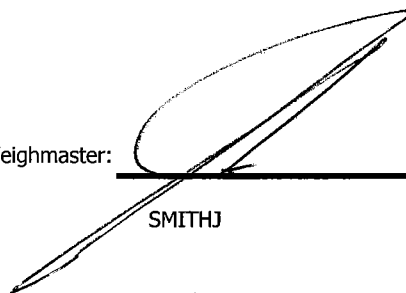

SMITHJ

Indemnification. Customer agrees, by signature above, to indemnify, hold harmless, and defend Republic Services, Inc., its subsidiaries, affiliates, employees, officers and directors from and against any and all liabilities, claims, penalties, forfeitures, suits and the costs and expenses incident thereto, including costs of defense, settlement, and reasonable attorney's fees, which may be incurred, as a result of death or injuries to any person, or damage to any property, contamination of or adverse effects on the environment, caused in whole or in part by the Customer, its employees, or subcontractors in disposing waste at this Facility. In the event Customer delivers Unacceptable Waste (as determined by Republic) Customer agrees to assume all expenses and obligations with the removal and/or resolution of any effects caused by the delivery of such Unacceptable Waste.

Indemnización. Cliente acuerda indemnizar, mantener inmune, y defender Republic Services, Inc., sus subsidiarios, compañías, divisiones, empleados, oficiales y directores contra de cualquiera y de todas responsabilidades, demandas, penas, pérdidas, juicios, pleitos y los costos incidente además, incluyendo costos de defensa, de acuerdo judicial, y de honorarios razonables del abogado, que pueden ser incurridos en, o como resultado de, la muerte o herida personal a cualquier persona, o daños a cualquier característica, propiedad, contaminación de la tierra o efectos ilícitos en esta Facilidad, causado entero o en parte por el cliente, sus empleados, o sus subcontratistas en botar basura en esta Facilidad. En el caso que el Cliente entrega, bota, basura (según lo determinado por Republic) en este Establecimiento basura inaceptable en los reglamentos de este Establecimiento, el Cliente se compromete asumir todos los costos y obligaciones con el retiro y/o la resolución de cualquier dano(s) causado por la entrega de tal basura inaceptable.



NON-HAZARDOUS WASTE MANIFEST

MANIFEST # 12007

GENERATOR INFORMATION

Generator Name: Tronox LLC
Address: P.O. Box 55
City: Henderson County: Clark
State: NV Zip: 89009
Site Location (if different): 560 W. Lake Mead
Henderson, NV 89015 (702) 592-7727

CUSTOMER/BILLING INFORMATION

Billing Name: NGE LLC c/o Northgate Environment Management
Address: 300 Frank Ogawa Plaza, Ste 510
City: Oakland County: Alameda
State: CA Zip: 94612

Table with 5 columns: Republic Services Approval #, Description of Waste, Volume/Weight, Expiration Date, Container Type. Row 1: 38251011244, Soil for disposal, 38.75 TD, 12-31-2011, Tractor with Dump Trailer(s).

*Attach Additional Sheet if necessary

I hereby certify that the above-described materials are non-hazardous wastes as defined by 40 CFR 261 or any applicable state law. Further, that the above named materials are properly classified, described, packaged, marked and labeled, and are in proper condition for transportation according to the applicable regulations of the Department of Transportation.

Susan Crowley (Signature)
Generator/Authorized Agent Name Signature Date Shipped

TRANSPORTER INFORMATION

Transporter Name: Las Vegas Paving DOT # 191949
Address: 4420 S. Decatur Truck Number: K002
Las Vegas, NV 89103 Phone Number: (702) 353-4355

I certify no hazardous waste or other regulated substance was knowingly introduced to the waste while in my custody. The waste transported in this vehicle is the waste identified above, to the best of my knowledge.

Diego Castell (Signature) Date Delivered 10-6-10
Name of Authorized Agent Signature Date Delivered

DISPOSAL SITE INFORMATION

Site Name: Apex Regional Landfill Phone No. (702) 599-5920
Address: 13550 U.S. Hwy 93 Las Vegas, NV

I hereby acknowledge receipt of the above described materials
Name (Print or Type) Signature Date Received 10-7-10

81 Environmental Tech
13550 N Highway 93
Las Vegas, NV 89165

Ticket Type: INBOUND INVOICE

Ticket Number: 1916
Date: 10/07/2010
Time In: 4:05 am
Time Out: 4:43 am

Customer: 001011 - NGE, LLC c/o Northgate Environ Mgmt

Vehicle/Container: 192456
Contract: Northgate Env. On Site Soils 3825 11
Comment: 3825 10 11244

Gross Weight: 128,460 LB Manual In
Tare Weight: 52,740 LB Manual Out
Net Weight: 75720 LB
Net Tons: 37.86

BOL: 12006

Origin	Yards	Material	Billing Quantity
Not Applicable	0.00 YD	SW CONTAMINATED SOIL	37.86 TN

Driver: _____



Weighmaster: _____

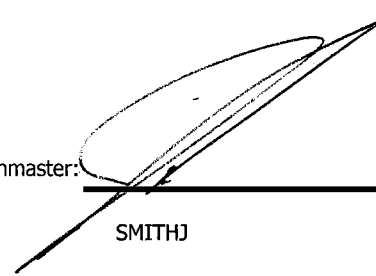

SMITHJ

Indemnification. Customer agrees, by signature above, to indemnify, hold harmless, and defend Republic Services, Inc., its subsidiaries, affiliates, employees, officers and directors from and against any and all liabilities, claims, penalties, forfeitures, suits and the costs and expenses incident thereto, including costs of defense, settlement, and reasonable attorney's fees, which may be incurred, as a result of death or injuries to any person, or damage to any property, contamination of or adverse effects on the environment, caused in whole or in part by the Customer, its employees, or subcontractors in disposing waste at this Facility. In the event Customer delivers Unacceptable Waste (as determined by Republic) Customer agrees to assume all expenses and obligations with the removal and/or resolution of any effects caused by the delivery of such Unacceptable Waste.

Indemnización. Cliente acuerda indemnizar, mantener inmune, y defender Republic Services, Inc., sus subsidiarios, compañías, divisiones, empleados, oficiales y directores contra de cualquiera y de todas responsabilidades, demandas, penas, pérdidas, juicios, pleitos y los costos incidente además, incluyendo costos de defensa, de acuerdo judicial, y de honorarios razonables del abogado, que pueden ser incurridos en, o como resultado de, la muerte o herida personal a cualquier persona, o daños a cualquier característica, propiedad, contaminación de la tierra o efectos ilícitos en esta Facilidad, causado entero o en parte por el cliente, sus empleados, o sus subcontratistas en botar basura en esta Facilidad. En el caso que el Cliente entrega, bota, basura (según lo determinado por Republic) en este Establecimiento basura inaceptable en los reglamentos de este Establecimiento, el Cliente se compromete asumir todos los costos y obligaciones con el retiro y/o la resolución de cualquier dano(s) causado por la entrega de tal basura inaceptable.



NON-HAZARDOUS WASTE MANIFEST

MANIFEST # 12006

GENERATOR INFORMATION

Generator Name: Tronox LLC

Address: P.O. Box 55

City: Henderson County: Clark

State: NV Zip: 89009

Site Location (if different): 560 W. Lake Mead

Henderson, NV 89015 (702) 592-7727

CUSTOMER/BILLING INFORMATION

Billing Name: NGE LLC c/o Northgate Environment Management

Address: 300 Frank Ogawa Plaza, Ste 510

City: Oakland County: Alameda

State: CA Zip: 94612

Republic Services Approval #	Description of Waste	Volume/Weight	Expiration Date	Container Type
38251011244	Soil for disposal		12-31-2011	Tractor with Dump Trailer(s)
	RZ- #	37.86 70		

*Attach Additional Sheet if necessary

I hereby certify that the above-described materials are non-hazardous wastes as defined by 40 CFR 261 or any applicable state law. Further, that the above named materials are properly classified, described, packaged, marked and labeled, and are in proper condition for transportation according to the applicable regulations of the Department of Transportation.

Susan Crowley

Signature: [Handwritten Signature]

Generator/Authorized Agent Name

Signature

Date Shipped

TRANSPORTER INFORMATION

Transporter Name: Las Vegas Paving

DOT # 191949

Address: 4420 S. Decatur

Truck Number: 192456

Las Vegas, NV 89103

Phone Number: (702) 353-4355

I certify no hazardous waste or other regulated substance was knowingly introduced to the waste while in my custody. The waste transported in this vehicle is the waste identified above, to the best of my knowledge.

[Handwritten Signature]

[Handwritten Signature]

10/16/10

Name of Authorized Agent

Signature

Date Delivered

DISPOSAL SITE INFORMATION

Site Name: Apex Regional Landfill

Phone No. (702) 599-5920

Address: 13550 U.S. Hwy 93 Las Vegas, NV

I hereby acknowledge receipt of the above described materials

[Handwritten Signature]

[Handwritten Signature]

10-2-10

Name (Print or Type)

Signature

Date Received

81 Environmental Tech
13550 N Highway 93
Las Vegas, NV 89165

Ticket Type: INBOUND INVOICE

Ticket Number: 1917
Date: 10/07/2010
Time In: 4:22 am
Time Out: 4:46 am

Customer: 001011 - NGE, LLC c/o Northgate Environ Mgmt

Vehicle/Container: 81496P
Contract: Northgate Env. On Site Soils 3825 11
Comment: 3825 10 11244

Gross Weight: 121,200 LB Manual In
Tare Weight: 50,660 LB Manual Out
Net Weight: 70540 LB
Net Tons: 35.27

BOL: 12009

Origin	Yards	Material	Billing Quantity
Not Applicable	0.00 YD	SW CONTAMINATED SOIL	35.27 TN

Driver:

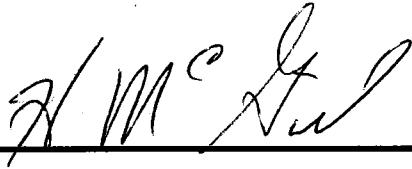

Weighmaster:

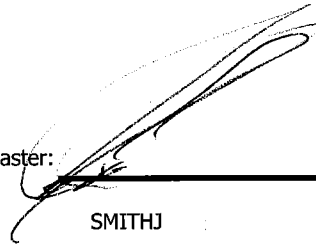
SMITHJ

Indemnification. Customer agrees, by signature above, to indemnify, hold harmless, and defend Republic Services, Inc., its subsidiaries, affiliates, employees, officers and directors from and against any and all liabilities, claims, penalties, forfeitures, suits and the costs and expenses incident thereto, including costs of defense, settlement, and reasonable attorney's fees, which may be incurred, as a result of death or injuries to any person, or damage to any property, contamination of or adverse effects on the environment, caused in whole or in part by the Customer, its employees, or subcontractors in disposing waste at this Facility. In the event Customer delivers Unacceptable Waste (as determined by Republic) Customer agrees to assume all expenses and obligations with the removal and/or resolution of any effects caused by the delivery of such Unacceptable Waste.

Indemnización. Cliente acuerda indemnizar, mantener inmune, y defender Republic Services, Inc., sus subsidiarios, compañías, divisiones, empleados, oficiales y directores contra de cualquiera y de todas responsabilidades, demandas, penas, pérdidas, juicios, pleitos y los costos incidente además, incluyendo costos de defensa, de acuerdo judicial, y de honorarios razonables del abogado, que pueden ser incurridos en, o como resultado de, la muerte o herida personal a cualquier persona, o daños a cualquier característica, propiedad, contaminación de la tierra o efectos ilícitos en esta Facilidad, causado entero o en parte por el cliente, sus empleados, o sus subcontratistas en botar basura en esta Facilidad. En el caso que el Cliente entrega, bota, basura (según lo determinado por Republic) en este Establecimiento basura inaceptable en los reglamentos de este Establecimiento, el Cliente se compromete asumir todos los costos y obligaciones con el retiro y/o la resolución de cualquier dano(s) causado por la entrega de tal basura inaceptable.



NON-HAZARDOUS WASTE MANIFEST

MANIFEST # 12009

GENERATOR INFORMATION

Generator Name: Tronox LLC

Address: P.O. Box 55

City: Henderson County: Clark

State: NV Zip: 89009

Site Location (if different): 560 W. Lake Mead

Henderson, NV 89015 (702) 592-7727

CUSTOMER/BILLING INFORMATION

Billing Name: NGE LLC c/o Northgate Environment Management

Address: 300 Frank Ogawa Plaza, Ste 510

City: Oakland County: Alameda

State: CA Zip: 94612

Republic Services Approval #	Description of Waste	Volume/Weight	Expiration Date	Container Type
38251011244	Soil for disposal		12-31-2011	Tractor with Dump Trailer(s)
	RZ- #	25-17-10		

*Attach Additional Sheet if necessary

I hereby certify that the above-described materials are non-hazardous wastes as defined by 40 CFR 261 or any applicable state law. Further, that the above named materials are properly classified, described, packaged, marked and labeled, and are in proper condition for transportation according to the applicable regulations of the Department of Transportation.

Susan Crowley (Signature) Generator/Authorized Agent Name Signature Date Shipped

TRANSPORTER INFORMATION

Transporter Name: Las Vegas Paving

DOT # 191949

Address: 4420 S. Decatur

Truck Number: 145

Las Vegas, NV 89103

Phone Number: (702) 353-4355

I certify no hazardous waste or other regulated substance was knowingly introduced to the waste while in my custody. The waste transported in this vehicle is the waste identified above, to the best of my knowledge.

Name of Authorized Agent (Signature) Signature Date Delivered 10-6-10

DISPOSAL SITE INFORMATION

Site Name: Apex Regional Landfill

Phone No. (702) 599-5920

Address: 13550 U.S. Hwy 93 Las Vegas, NV

I hereby acknowledge receipt of the above described materials Name (Print or Type) Signature Date Received 10-2-10

81 Environmental Tech
13550 N Highway 93
Las Vegas, NV 89165

Ticket Type: INBOUND INVOICE

Ticket Number: 1918
Date: 10/07/2010
Time In: 4:27 am
Time Out: 4:51 am

Customer: 001011 - NGE, LLC c/o Northgate Environ Mgmt

Vehicle/Container: 81495P
Contract: Northgate Env. On Site Soils 3825 11
Comment: 3825 10 11244

Gross Weight: 120,820 LB Manual In
Tare Weight: 53,340 LB Manual Out
Net Weight: 67480 LB
Net Tons: 33.74

BOL: 12010

Origin	Yards	Material	Billing	Quantity
Not Applicable	0.00 YD	SW CONTAMINATED SOIL	33.74	TN

Driver: _____



Weighmaster: _____

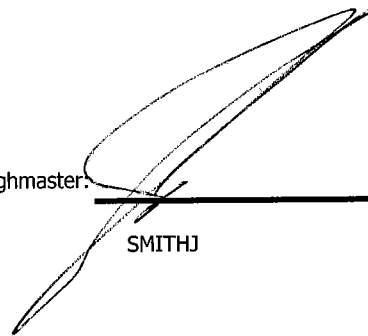

SMITHJ

Indemnification. Customer agrees, by signature above, to indemnify, hold harmless, and defend Republic Services, Inc., its subsidiaries, affiliates, employees, officers and directors from and against any and all liabilities, claims, penalties, forfeitures, suits and the costs and expenses incident thereto, including costs of defense, settlement, and reasonable attorney's fees, which may be incurred, as a result of death or injuries to any person, or damage to any property, contamination of or adverse effects on the environment, caused in whole or in part by the Customer, its employees, or subcontractors in disposing waste at this Facility. In the event Customer delivers Unacceptable Waste (as determined by Republic) Customer agrees to assume all expenses and obligations with the removal and/or resolution of any effects caused by the delivery of such Unacceptable Waste.

Indemnización. Cliente acuerda indemnizar, mantener inmune, y defender Republic Services, Inc., sus subsidiarios, compañías, divisiones, empleados, oficiales y directores contra de cualquiera y de todas responsabilidades, demandas, penas, pérdidas, juicios, pleitos y los costos incidente además, incluyendo costos de defensa, de acuerdo judicial, y de honorarios razonables del abogado, que pueden ser incurridos en, o como resultado de, la muerte o herida personal a cualquier persona, o daños a cualquier característica, propiedad, contaminación de la tierra o efectos ilícitos en esta Facilidad, causado entero o en parte por el cliente, sus empleados, o sus subcontratistas en botar basura en esta Facilidad. En el caso que el Cliente entrega, bota, basura (según lo determinado por Republic) en este Establecimiento basura inaceptable en los reglamentos de este Establecimiento, el Cliente se compromete asumir todos los costos y obligaciones con el retiro y/o la resolución de cualquier dano(s) causado por la entrega de tal basura inaceptable.



SR 40236
NON-HAZARDOUS WASTE MANIFEST

MANIFEST # 12010

GENERATOR INFORMATION

Generator Name: Tronox LLC

Address: P.O. Box 55

City: Henderson County: Clark

State: NV Zip: 89009

Site Location (if different): 560 W. Lake Mead

Henderson, NV 89015 (702) 592-7727

CUSTOMER/BILLING INFORMATION

Billing Name: NGE LLC e/o Northgate Environment Management

Address: 300 Frank Ogawa Plaza, Ste 510

City: Oakland County: Alameda

State: CA Zip: 94612

Republic Services Approval #	Description of Waste	Volume/Weight	Expiration Date	Container Type
38251011244	Soil for disposal		12-31-2011	Tractor with Dump Trailer(s)
	RZ- _____ # _____	33.74 TN		

*Attach Additional Sheet if necessary

I hereby certify that the above-described materials are non-hazardous wastes as defined by 40 CFR 261 or any applicable state law. Further, that the above named materials are properly classified, described, packaged, marked and labeled, and are in proper condition for transportation according to the applicable regulations of the Department of Transportation.

Susan Crowley _____
Generator/Authorized Agent Name Signature Date Shipped

TRANSPORTER INFORMATION

Transporter Name: Las Vegas Paving

DOT # 191949

Address: 4420 S. Decatur

Truck Number: 175

Las Vegas, NV 89103

Phone Number: (702) 353-4355

I certify no hazardous waste or other regulated substance was knowingly introduced to the waste while in my custody. The waste transported in this vehicle is the waste identified above, to the best of my knowledge.

Larry Harnsberger _____ 10-6-10
Name of Authorized Agent Signature Date Delivered

DISPOSAL SITE INFORMATION

Site Name: Apex Regional Landfill

Phone No. (702) 599-5920

Address: 13550 U.S. Hwy 93 Las Vegas, NV

I hereby acknowledge receipt of the above described materials
Jose S. [Signature] _____ 10-2-10
Name (Print or Type) Signature Date Received

81 Environmental Tech
13550 N Highway 93
Las Vegas, NV 89165

Ticket Type: INBOUND INVOICE

Ticket Number: 1920
Date: 10/07/2010
Time In: 4:29 am
Time Out: 5:36 am

Customer: 001011 - NGE, LLC c/o Northgate Environ Mgmt

Vehicle/Container: 81494P
Contract: Northgate Env. On Site Soils 3825 11
Comment: 3825 10 11244

Gross Weight: 115,720 LB Manual In
Tare Weight: 44,600 LB Manual Out
Net Weight: 71120 LB
Net Tons: 35.56

BOL: 12011

Origin	Yards	Material	Billing	Quantity
Not Applicable	0.00 YD	SW CONTAMINATED SOIL	35.56	TN

Driver: _____



Weighmaster: _____



IN - SMITHJ OUT - MORENOJ

Indemnification. Customer agrees, by signature above, to indemnify, hold harmless, and defend Republic Services, Inc., its subsidiaries, affiliates, employees, officers and directors from and against any and all liabilities, claims, penalties, forfeitures, suits and the costs and expenses incident thereto, including costs of defense, settlement, and reasonable attorney's fees, which may be incurred, as a result of death or injuries to any person, or damage to any property, contamination of or adverse effects on the environment, caused in whole or in part by the Customer, its employees, or subcontractors in disposing waste at this Facility. In the event Customer delivers Unacceptable Waste (as determined by Republic) Customer agrees to assume all expenses and obligations with the removal and/or resolution of any effects caused by the delivery of such Unacceptable Waste.

Indemnización. Cliente acuerda indemnizar, mantener inmune, y defender Republic Services, Inc., sus subsidiarios, compañías, divisiones, empleados, oficiales y directores contra de cualquiera y de todas responsabilidades, demandas, penas, pérdidas, juicios, pleitos y los costos incidente además, incluyendo costos de defensa, de acuerdo judicial, y de honorarios razonables del abogado, que pueden ser incurridos en, o como resultado de, la muerte o herida personal a cualquier persona, o daños a cualquier característica, propiedad, contaminación de la tierra o efectos ilícitos en esta Facilidad, causado entero o en parte por el cliente, sus empleados, o sus subcontratistas en botar basura en esta Facilidad. En el caso que el Cliente entrega, bota, basura (según lo determinado por Republic) en este Establecimiento basura inaceptable en los reglamentos de este Establecimiento, el Cliente se compromete asumir todos los costos y obligaciones con el retiro y/o la resolución de cualquier dano(s) causado por la entrega de tal basura inaceptable.



NON-HAZARDOUS WASTE MANIFEST

MANIFEST # 12011

GENERATOR INFORMATION

Generator Name: Tronox LLC
Address: P.O. Box 55
City: Henderson County: Clark
State: NV Zip: 89009
Site Location (if different): 560 W. Lake Mead
Henderson, NV 89015 (702) 592-7727

CUSTOMER/BILLING INFORMATION

Billing Name: NGE LLC c/o Northgate Environment Management
Address: 300 Frank Ogawa Plaza, Ste 510
City: Oakland County: Alameda
State: CA Zip: 94612

Table with 5 columns: Republic Services Approval #, Description of Waste, Volume/Weight, Expiration Date, Container Type. Row 1: 38251011244, Soil for disposal, 35.56, 12-31-2011, Tractor with Dump Trailer(s).

*Attach Additional Sheet if necessary

I hereby certify that the above-described materials are non-hazardous wastes as defined by 40 CFR 261 or any applicable state law. Further, that the above named materials are properly classified, described, packaged, marked and labeled, and are in proper condition for transportation according to the applicable regulations of the Department of Transportation.

Susan Crowley (Signature)
Generator/Authorized Agent Name Signature Date Shipped

TRANSPORTER INFORMATION

Transporter Name: Las Vegas Paving DOT # 191949
Address: 4420 S. Decatur Truck Number: 125
Las Vegas, NV 89103 Phone Number: (702) 353-4355

I certify no hazardous waste or other regulated substance was knowingly introduced to the waste while in my custody. The waste transported in this vehicle is the waste identified above, to the best of my knowledge.

Calvin Paguza (Signature)
Name of Authorized Agent Signature Date Delivered 10-06-10

DISPOSAL SITE INFORMATION

Site Name: Apex Regional Landfill Phone No. (702) 599-5920
Address: 13550 U.S. Hwy 93 Las Vegas, NV

I hereby acknowledge receipt of the above described materials.
Juan Moreno (Signature)
Name (Print or Type) Signature Date Received 10-6-10

81 Environmental Tech
13550 N Highway 93
Las Vegas, NV 89165

Ticket Type: INBOUND INVOICE

Ticket Number: 1921
Date: 10/07/2010
Time In: 8:06 am
Time Out: 8:36 am

Customer: 001011 - NGE, LLC c/o Northgate Environ Mgmt

Vehicle/Container: 81495P

Gross Weight: 139,060 LB Manual In
Tare Weight: 51,480 LB Manual Out
Net Weight: 87580 LB
Net Tons: 43.79

Contract: Northgate Env. On Site Soils 3825 11

Comment: 3825-10-11244 -175

BOL: 12012

Origin	Yards	Material	Billing Quantity
Not Applicable	0.00 YD	SW CONTAMINATED SOIL	43.79 TN

Driver: 

Weighmaster: 

IN - WALKERA OUT - MORENOJ

Indemnification. Customer agrees, by signature above, to indemnify, hold harmless, and defend Republic Services, Inc., its subsidiaries, affiliates, employees, officers and directors from and against any and all liabilities, claims, penalties, forfeitures, suits and the costs and expenses incident thereto, including costs of defense, settlement, and reasonable attorney's fees, which may be incurred, as a result of death or injuries to any person, or damage to any property, contamination of or adverse effects on the environment, caused in whole or in part by the Customer, its employees, or subcontractors in disposing waste at this Facility. In the event Customer delivers Unacceptable Waste (as determined by Republic) Customer agrees to assume all expenses and obligations with the removal and/or resolution of any effects caused by the delivery of such Unacceptable Waste.

Indemnización. Cliente acuerda indemnizar, mantener inmune, y defender Republic Services, Inc., sus subsidiarios, compañías, divisiones, empleados, oficiales y directores contra de cualquiera y de todas responsabilidades, demandas, penas, pérdidas, juicios, pleitos y los costos incidente además, incluyendo costos de defensa, de acuerdo judicial, y de honorarios razonables del abogado, que pueden ser incurridos en, o como resultado de, la muerte o herida personal a cualquier persona, o daños a cualquier característica, propiedad, contaminación de la tierra o efectos ilícitos en esta Facilidad, causado entero o en parte por el cliente, sus empleados, o sus subcontratistas en botar basura en esta Facilidad. En el caso que el Cliente entrega, bota, basura (según lo determinado por Republic) en este Establecimiento basura inaceptable en los reglamentos de este Establecimiento, el Cliente se compromete asumir todos los costos y obligaciones con el retiro y/o la resolución de cualquier dano(s) causado por la entrega de tal basura inaceptable.



GENERATOR INFORMATION

Generator Name: Tronox LLC

Address: P.O. Box 55

City: Henderson County: Clark

State: NV Zip: 89009

Site Location (if different): 560 W. Lake Mead
Henderson, NV 89015 (702) 592-7727

CUSTOMER/BILLING INFORMATION

Billing Name: NGE LLC c/o Northgate Environment Management

Address: 300 Frank Ogawa Plaza, Ste 510

City: Oakland County: Alameda

State: CA Zip: 94612

Republic Services Approval #	Description of Waste	Volume/Weight	Expiration Date	Container Type
38251011244	Soil for disposal		12-31-2011	Tractor with Dump Trailer(s)
	RZ- #	43.79 TN		

*Attach Additional Sheet if necessary

I hereby certify that the above-described materials are non-hazardous wastes as defined by 40 CFR 261 or any applicable state law. Further, that the above named materials are properly classified, described, packaged, marked and labeled, and are in proper condition for transportation according to the applicable regulations of the Department of Transportation.

Susan Crowley *Susan Crowley* _____

Generator/Authorized Agent Name Signature Date Shipped

TRANSPORTER INFORMATION

Transporter Name: Las Vegas Paving DOT # 191949

Address: 4420 S. Decatur Truck Number: 175

Las Vegas, NV 89103 Phone Number: (702) 353-4355

I certify no hazardous waste or other regulated substance was knowingly introduced to the waste while in my custody. The waste transported in this vehicle is the waste identified above, to the best of my knowledge.

Larry Harrisberger *Larry Harrisberger* 10-07-10

Name of Authorized Agent Signature Date Delivered

DISPOSAL SITE INFORMATION

Site Name: Apex Regional Landfill Phone No. (702) 599-5920

Address: 13550 U.S. Hwy 93 Las Vegas, NV

I hereby acknowledge receipt of the above described materials

Juan Moreno *Juan Moreno* 10-7-10

Name (Print or Type) Signature Date Received

81 Environmental Tech
13550 N Highway 93
Las Vegas, NV 89165

Ticket Type: INBOUND INVOICE

Ticket Number: 1922
Date: 10/07/2010
Time In: 8:09 am
Time Out: 8:37 am

Customer: 001011 - NGE, LLC c/o Northgate Environ Mgmt

Vehicle/Container: 73072P
Contract: Northgate Env. On Site Soils 3825 11
Comment: #135 3825 10 11244

Gross Weight: 140,580 LB Manual In
Tare Weight: 51,060 LB Scale Out
Net Weight: 89520 LB
Net Tons: 44.76

BOL: 12013

Origin	Yards	Material	Billing	Quantity
Not Applicable	0.00 YD	SW CONTAMINATED SOIL	44.76	TN

Driver: _____



Weighmaster: _____

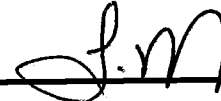

IN - WALKERA OUT - MORENOJ

Indemnification. Customer agrees, by signature above, to indemnify, hold harmless, and defend Republic Services, Inc., its subsidiaries, affiliates, employees, officers and directors from and against any and all liabilities, claims, penalties, forfeitures, suits and the costs and expenses incident thereto, including costs of defense, settlement, and reasonable attorney's fees, which may be incurred, as a result of death or injuries to any person, or damage to any property, contamination of or adverse effects on the environment, caused in whole or in part by the Customer, its employees, or subcontractors in disposing waste at this Facility. In the event Customer delivers Unacceptable Waste (as determined by Republic) Customer agrees to assume all expenses and obligations with the removal and/or resolution of any effects caused by the delivery of such Unacceptable Waste.

Indemnización. Cliente acuerda indemnizar, mantener inmune, y defender Republic Services, Inc., sus subsidiarios, compañías, divisiones, empleados, oficiales y directores contra de cualquiera y de todas responsabilidades, demandas, penas, pérdidas, juicios, pleitos y los costos incidente además, incluyendo costos de defensa, de acuerdo judicial, y de honorarios razonables del abogado, que pueden ser incurridos en, o como resultado de, la muerte o herida personal a cualquier persona, o daños a cualquier característica, propiedad, contaminación de la tierra o efectos ilícitos en esta Facilidad, causado entero o en parte por el cliente, sus empleados, o sus subcontratistas en botar basura en esta Facilidad. En el caso que el Cliente entrega, bota, basura (según lo determinado por Republic) en este Establecimiento basura inaceptable en los reglamentos de este Establecimiento, el Cliente se compromete asumir todos los costos y obligaciones con el retiro y/o la resolución de cualquier dano(s) causado por la entrega de tal basura inaceptable.



NON-HAZARDOUS WASTE MANIFEST

MANIFEST # 12013

GENERATOR INFORMATION

Generator Name: Tronox LLC
Address: P.O. Box 55
City: Henderson County: Clark
State: NV Zip: 89009
Site Location (if different): 560 W. Lake Mead
Henderson, NV 89015 (702) 592-7727

CUSTOMER/BILLING INFORMATION

Billing Name: NGE LLC c/o Northgate Environment Management
Address: 300 Frank Ogawa Plaza, Ste 510
City: Oakland County: Alameda
State: CA Zip: 94612

Table with 5 columns: Republic Services Approval #, Description of Waste, Volume/Weight, Expiration Date, Container Type. Row 1: 38251011244, Soil for disposal, 44.76 TN, 12-31-2011, Tractor with Dump Trailer(s).

*Attach Additional Sheet if necessary

I hereby certify that the above-described materials are non-hazardous wastes as defined by 40 CFR 261 or any applicable state law. Further, that the above named materials are properly classified, described, packaged, marked and labeled, and are in proper condition for transportation according to the applicable regulations of the Department of Transportation.

Susan Crowley (Name), [Signature] (Signature), 10-7-10 (Date Shipped)
Generator/Authorized Agent Name Signature Date Shipped

TRANSPORTER INFORMATION

Transporter Name: Las Vegas Paving DOT # 191949
Address: 4420 S. Decatur Truck Number: 135
Las Vegas, NV 89103 Phone Number: (702) 353-4355

I certify no hazardous waste or other regulated substance was knowingly introduced to the waste while in my custody. The waste transported in this vehicle is the waste identified above, to the best of my knowledge.

Robert Lee (Name), [Signature] (Signature), 10-7-10 (Date Delivered)
Name of Authorized Agent Signature Date Delivered

DISPOSAL SITE INFORMATION

Site Name: Apex Regional Landfill Phone No. (702) 599-5920
Address: 13550 U.S. Hwy 93 Las Vegas, NV

I hereby acknowledge receipt of the above described materials
[Signature] (Name), [Signature] (Signature), 10-7-10 (Date Received)
Name (Print or Type) Signature Date Received

81 Environmental Tech
13550 N Highway 93
Las Vegas, NV 89165

Ticket Type: INBOUND INVOICE

Ticket Number: 1923
Date: 10/07/2010
Time In: 8:14 am
Time Out: 8:42 am

Customer: 001011 - NGE, LLC c/o Northgate Environ Mgmt

Vehicle/Container: SR142
Contract: Northgate Env. On Site Soils 3825 11
Comment: 3825 10 11244

Gross Weight: 143,460 LB Manual In
Tare Weight: 58,720 LB Manual Out
Net Weight: 84740 LB
Net Tons: 42.37

12014

Origin	Yards	Material	Billing	Quantity
Not Applicable	0.00 YD	SW CONTAMINATED SOIL	42.37	TN

Driver:



Weighmaster:

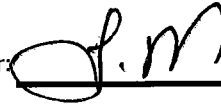

MORENOJ

Indemnification. Customer agrees, by signature above, to indemnify, hold harmless, and defend Republic Services, Inc., its subsidiaries, affiliates, employees, officers and directors from and against any and all liabilities, claims, penalties, forfeitures, suits and the costs and expenses incident thereto, including costs of defense, settlement, and reasonable attorney's fees, which may be incurred, as a result of death or injuries to any person, or damage to any property, contamination of or adverse effects on the environment, caused in whole or in part by the Customer, its employees, or subcontractors in disposing waste at this Facility. In the event Customer delivers Unacceptable Waste (as determined by Republic) Customer agrees to assume all expenses and obligations with the removal and/or resolution of any effects caused by the delivery of such Unacceptable Waste.

Indemnización. Cliente acuerda indemnizar, mantener inmune, y defender Republic Services, Inc., sus subsidiarios, compañías, divisiones, empleados, oficiales y directores contra de cualquiera y de todas responsabilidades, demandas, penas, pérdidas, juicios, pleitos y los costos incidente además, incluyendo costos de defensa, de acuerdo judicial, y de honorarios razonables del abogado, que pueden ser incurridos en, o como resultado de, la muerte o herida personal a cualquier persona, o daños a cualquier característica, propiedad, contaminación de la tierra o efectos ilícitos en esta Facilidad, causado entero o en parte por el cliente, sus empleados, o sus subcontratistas en botar basura en esta Facilidad. En el caso que el Cliente entrega, bota, basura (según lo determinado por Republic) en este Establecimiento basura inaceptable en los reglamentos de este Establecimiento, el Cliente se compromete asumir todos los costos y obligaciones con el retiro y/o la resolución de cualquier dano(s) causado por la entrega de tal basura inaceptable.



NON-HAZARDOUS WASTE MANIFEST

MANIFEST # 12014

GENERATOR INFORMATION

Generator Name: Tronox LLC
Address: P.O. Box 55
City: Henderson County: Clark
State: NV Zip: 89009
Site Location (if different): 560 W. Lake Mead
Henderson, NV 89015 (702) 592-7727

CUSTOMER/BILLING INFORMATION

Billing Name: NGE LLC c/o Northgate Environment Management
Address: 300 Frank Ogawa Plaza, Ste 510
City: Oakland County: Alameda
State: CA Zip: 94612

Table with 5 columns: Republic Services Approval #, Description of Waste, Volume/Weight, Expiration Date, Container Type. Row 1: 38251011244, Soil for disposal, 42.37 TN, 12-31-2011, Tractor with Dump Trailer(s).

*Attach Additional Sheet if necessary

I hereby certify that the above-described materials are non-hazardous wastes as defined by 40 CFR 261 or any applicable state law. Further, that the above named materials are properly classified, described, packaged, marked and labeled, and are in proper condition for transportation according to the applicable regulations of the Department of Transportation.

Susan Crowley (Signature)
Generator/Authorized Agent Name Signature Date Shipped

TRANSPORTER INFORMATION

Transporter Name: Las Vegas Paving DOT # 191949
Address: 4420 S. Decatur Truck Number: 142
Las Vegas, NV 89103 Phone Number: (702) 353-4355

I certify no hazardous waste or other regulated substance was knowingly introduced to the waste while in my custody. The waste transported in this vehicle is the waste identified above, to the best of my knowledge

Elbert (Signature)
Name of Authorized Agent Signature Date Delivered 10-7-10

DISPOSAL SITE INFORMATION

Site Name: Apex Regional Landfill Phone No. (702) 599-5920
Address: 13550 U.S. Hwy 93 Las Vegas, NV

I hereby acknowledge receipt of the above described materials
Juan Moreno (Signature)
Name (Print or Type) Signature Date Received 10-7-10

81 Environmental Tech
13550 N Highway 93
Las Vegas, NV 89165

Ticket Type: INBOUND INVOICE

Ticket Number: 1925
Date: 10/07/2010
Time In: 8:14 am
Time Out: 8:47 am

Customer: 001011 - NGE, LLC c/o Northgate Environ Mgmt

Vehicle/Container: 81494P
Contract: Northgate Env. On Site Soils 3825 1f
Comment: C&N 125 3825 10 11244

Gross Weight: 119,360 LB Manual In
Tare Weight: 51,360 LB Manual Out
Net Weight: 68000 LB
Net Tons: 34.00

BOL: 12015

Origin	Yards	Material	Billing Quantity
Not Applicable	0.00 YD	SW CONTAMINATED SOIL	34.00 TN

Driver: _____

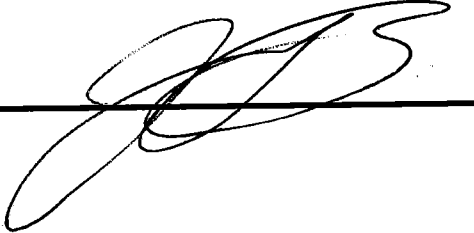

Weighmaster: _____

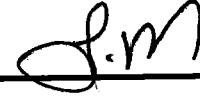

IN - WALKERA OUT - MORENOJ

Indemnification. Customer agrees, by signature above, to indemnify, hold harmless, and defend Republic Services, Inc., its subsidiaries, affiliates, employees, officers and directors from and against any and all liabilities, claims, penalties, forfeitures, suits and the costs and expenses incident thereto, including costs of defense, settlement, and reasonable attorney's fees, which may be incurred, as a result of death or injuries to any person, or damage to any property, contamination of or adverse effects on the environment, caused in whole or in part by the Customer, its employees, or subcontractors in disposing waste at this Facility. In the event Customer delivers Unacceptable Waste (as determined by Republic) Customer agrees to assume all expenses and obligations with the removal and/or resolution of any effects caused by the delivery of such Unacceptable Waste.

Indemnización. Cliente acuerda indemnizar, mantener inmune, y defender Republic Services, Inc., sus subsidiarios, compañías, divisiones, empleados, oficiales y directores contra de cualquiera y de todas responsabilidades, demandas, penas, pérdidas, juicios, pleitos y los costos incidente además, incluyendo costos de defensa, de acuerdo judicial, y de honorarios razonables del abogado, que pueden ser incurridos en, o como resultado de, la muerte o herida personal a cualquier persona, o daños a cualquier característica, propiedad, contaminación de la tierra o efectos ilícitos en esta Facilidad, causado entero o en parte por el cliente, sus empleados, o sus subcontratistas en botar basura en esta Facilidad. En el caso que el Cliente entrega, bota, basura (según lo determinado por Republic) en este Establecimiento basura inaceptable en los reglamentos de este Establecimiento, el Cliente se compromete asumir todos los costos y obligaciones con el retiro y/o la resolución de cualquier dano(s) causado por la entrega de tal basura inaceptable.



NON-HAZARDOUS WASTE MANIFEST

MANIFEST # 12015

GENERATOR INFORMATION

Generator Name: Tronox LLC
Address: P.O. Box 55
City: Henderson County: Clark
State: NV Zip: 89009
Site Location (if different): 560 W. Lake Mead
Henderson, NV 89015 (702) 592-7727

CUSTOMER/BILLING INFORMATION

Billing Name: NGE LLC c/o Northgate Environment Management
Address: 300 Frank Ogawa Plaza, Ste 510
City: Oakland County: Alameda
State: CA Zip: 94612

Table with 5 columns: Republic Services Approval #, Description of Waste, Volume/Weight, Expiration Date, Container Type. Row 1: 38251011244, Soil for disposal, 34.00, 12-31-2011, Tractor with Dump Trailer(s). Row 2: RZ- #

*Attach Additional Sheet if necessary

I hereby certify that the above-described materials are non-hazardous wastes as defined by 40 CFR 261 or any applicable state law. Further, that the above named materials are properly classified, described, packaged, marked and labeled, and are in proper condition for transportation according to the applicable regulations of the Department of Transportation.

Susan Crowley (Name)
Tom Crowley (Signature)
Date Shipped (Blank)

TRANSPORTER INFORMATION

Transporter Name: Las Vegas Paving DOT # 191949
Address: 4420 S. Decatur Truck Number: 125
Las Vegas, NV 89103 Phone Number: (702) 353-4355

I certify no hazardous waste or other regulated substance was knowingly introduced to the waste while in my custody. The waste transported in this vehicle is the waste identified above, to the best of my knowledge.

J Dwyer (Name of Authorized Agent)
Signature (Signature)
Date Delivered: 10-7-10

DISPOSAL SITE INFORMATION

Site Name: Apex Regional Landfill Phone No. (702) 599-5920
Address: 13550 U.S. Hwy 93 Las Vegas, NV

I hereby acknowledge receipt of the above described materials
Ariel Drake-Walker (Name)
Signature (Signature)
Date Received: 10/7/10

81 Environmental Tech
13550 N Highway 93
Las Vegas, NV 89165

Ticket Type: INBOUND INVOICE

Ticket Number: 1926
Date: 10/07/2010
Time In: 8:23 am
Time Out: 8:50 am

Customer: 001011 - NGE, LLC c/o Northgate Environ Mgmt

Vehicle/Container: 81496P
Contract: Northgate Env. On Site Soils 3825 11
Comment: C&N 145 3825 10 11244

Gross Weight: 121,040 LB Manual In
Tare Weight: 50,420 LB Manual Out
Net Weight: 70620 LB
Net Tons: 35.31

BOL: 12016

Origin	Yards	Material	Billing	Quantity
Not Applicable	0.00 YD	SW CONTAMINATED SOIL	35.31	TN

Driver: _____

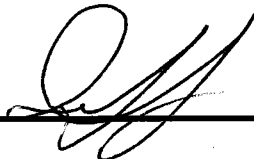

Weighmaster: _____

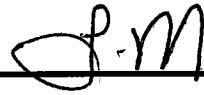

IN - WALKERA OUT - MORENOJ

Indemnification. Customer agrees, by signature above, to indemnify, hold harmless, and defend Republic Services, Inc., its subsidiaries, affiliates, employees, officers and directors from and against any and all liabilities, claims, penalties, forfeitures, suits and the costs and expenses incident thereto, including costs of defense, settlement, and reasonable attorney's fees, which may be incurred, as a result of death or injuries to any person, or damage to any property, contamination of or adverse effects on the environment, caused in whole or in part by the Customer, its employees, or subcontractors in disposing waste at this Facility. In the event Customer delivers Unacceptable Waste (as determined by Republic) Customer agrees to assume all expenses and obligations with the removal and/or resolution of any effects caused by the delivery of such Unacceptable Waste.

Indemnización. Cliente acuerda indemnizar, mantener inmune, y defender Republic Services, Inc., sus subsidiarios, compañías, divisiones, empleados, oficiales y directores contra de cualquiera y de todas responsabilidades, demandas, penas, pérdidas, juicios, pleitos y los costos incidente además, incluyendo costos de defensa, de acuerdo judicial, y de honorarios razonables del abogado, que pueden ser incurridos en, o como resultado de, la muerte o herida personal a cualquier persona, o daños a cualquier característica, propiedad, contaminación de la tierra o efectos ilícitos en esta Facilidad, causado entero o en parte por el cliente, sus empleados, o sus subcontratistas en botar basura en esta Facilidad. En el caso que el Cliente entrega, bota, basura (según lo determinado por Republic) en este Establecimiento basura inaceptable en los reglamentos de este Establecimiento, el Cliente se compromete asumir todos los costos y obligaciones con el retiro y/o la resolución de cualquier dano(s) causado por la entrega de tal basura inaceptable.



NON-HAZARDOUS WASTE MANIFEST

MANIFEST # 12016

GENERATOR INFORMATION

Generator Name: Tronox LLCAddress: P.O. Box 55City: Henderson County: ClarkState: NV Zip: 89009Site Location (if different): 560 W. Lake MeadHenderson, NV 89015 (702) 592-7727

CUSTOMER/BILLING INFORMATION

Billing Name: NGE LLC c/o Northgate Environment ManagementAddress: 300 Frank Ogawa Plaza, Ste 510City: Oakland County: AlamedaState: CA Zip: 94612

Republic Services Approval #	Description of Waste	Volume/Weight	Expiration Date	Container Type
38251011244	Soil for disposal		12-31-2011	Tractor with Dump Trailer(s)
	RZ- #	35.31		

*Attach Additional Sheet if necessary

I hereby certify that the above-described materials are non-hazardous wastes as defined by 40 CFR 261 or any applicable state law. Further, that the above named materials are properly classified, described, packaged, marked and labeled, and are in proper condition for transportation according to the applicable regulations of the Department of Transportation.

Susan Crowley *Susan Crowley*
 Generator/Authorized Agent Name Signature Date Shipped

TRANSPORTER INFORMATION

Transporter Name: Las Vegas PavingDOT # 191949Address: 4420 S. DecaturTruck Number: 145Las Vegas, NV 89103Phone Number: (702) 353-4355

I certify no hazardous waste or other regulated substance was knowingly introduced to the waste while in my custody. The waste transported in this vehicle is the waste identified above, to the best of my knowledge.

[Signature] #145 10-7-10
 Name of Authorized Agent Signature Date Delivered

DISPOSAL SITE INFORMATION

Site Name: Apex Regional LandfillPhone No. (702) 599-5920Address: 13550 U.S. Hwy 93 Las Vegas, NV

I hereby acknowledge receipt of the above described materials

Cristal Drake-Walker *Amal D.W.* 10/7/10
 Name (Print or Type) Signature Date Received

81 Environmental Tech
13550 N Highway 93
Las Vegas, NV 89165

Ticket Type: INBOUND INVOICE

Ticket Number: 1927
Date: 10/07/2010
Time In: 8:42 am
Time Out: 9:12 am

Customer: 001011 - NGE, LLC c/o Northgate Environ Mgmt

Vehicle/Container: 82515P
Contract: Northgate Env. On Site Soils 3825 11
Comment: 3825-10-11244

Gross Weight: 137,880 LB Manual In
Tare Weight: 53,000 LB Scale Out
Net Weight: 84880 LB
Net Tons: 42.44

BOL: 12017

Origin	Yards	Material	Billing	Quantity
Not Applicable	0.00 YD	SW CONTAMINATED SOIL	42.44	TN

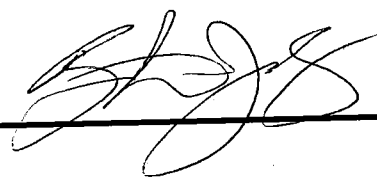
Driver: 

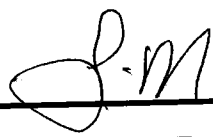
Weighmaster: 
IN - WALKERA OUT - MORENOJ

Indemnification. Customer agrees, by signature above, to indemnify, hold harmless, and defend Republic Services, Inc., its subsidiaries, affiliates, employees, officers and directors from and against any and all liabilities, claims, penalties, forfeitures, suits and the costs and expenses incident thereto, including costs of defense, settlement, and reasonable attorney's fees, which may be incurred, as a result of death or injuries to any person, or damage to any property, contamination of or adverse effects on the environment, caused in whole or in part by the Customer, its employees, or subcontractors in disposing waste at this Facility. In the event Customer delivers Unacceptable Waste (as determined by Republic) Customer agrees to assume all expenses and obligations with the removal and/or resolution of any effects caused by the delivery of such Unacceptable Waste.

Indemnización. Cliente acuerda indemnizar, mantener inmune, y defender Republic Services, Inc., sus subsidiarios, compañías, divisiones, empleados, oficiales y directores contra de cualquiera y de todas responsabilidades, demandas, penas, pérdidas, juicios, pleitos y los costos incidente además, incluyendo costos de defensa, de acuerdo judicial, y de honorarios razonables del abogado, que pueden ser incurridos en, o como resultado de, la muerte o herida personal a cualquier persona, o daños a cualquier característica, propiedad, contaminación de la tierra o efectos ilícitos en esta Facilidad, causado entero o en parte por el cliente, sus empleados, o sus subcontratistas en botar basura en esta Facilidad. En el caso que el Cliente entrega, bota, basura (según lo determinado por Republic) en este Establecimiento basura inaceptable en los reglamentos de este Establecimiento, el Cliente se compromete asumir todos los costos y obligaciones con el retiro y/o la resolución de cualquier dano(s) causado por la entrega de tal basura inaceptable.



NON-HAZARDOUS WASTE MANIFEST

MANIFEST # 12017

GENERATOR INFORMATION

Generator Name: Tronox LLC
Address: P.O. Box 55
City: Henderson County: Clark
State: NV Zip: 89009
Site Location (if different): 560 W. Lake Mead
Henderson, NV 89015 (702) 592-7727

CUSTOMER/BILLING INFORMATION

Billing Name: NGE LLC c/o Northgate Environment Management
Address: 300 Frank Ogawa Plaza, Ste 510
City: Oakland County: Alameda
State: CA Zip: 94612

Table with 5 columns: Republic Services Approval #, Description of Waste, Volume/Weight, Expiration Date, Container Type. Row 1: 38251011244, Soil for disposal, 22.44, 12-31-2011, Tractor with Dump Trailer(s).

*Attach Additional Sheet if necessary

I hereby certify that the above-described materials are non-hazardous wastes as defined by 40 CFR 261 or any applicable state law. Further, that the above named materials are properly classified, described, packaged, marked and labeled, and are in proper condition for transportation according to the applicable regulations of the Department of Transportation.

Susan Crowley
Generator/Authorized Agent Name Signature Date Shipped

TRANSPORTER INFORMATION

Transporter Name: Las Vegas Paving DOT # 191949
Address: 4420 S. Decatur Truck Number: 144
Las Vegas, NV 89103 Phone Number: (702) 353-4355

I certify no hazardous waste or other regulated substance was knowingly introduced to the waste while in my custody. The waste transported in this vehicle is the waste identified above, to the best of my knowledge.

Name of Authorized Agent Signature Date Delivered 10-7-10

DISPOSAL SITE INFORMATION

Site Name: Apex Regional Landfill Phone No. (702) 599-5920
Address: 13550 U.S. Hwy 93 Las Vegas, NV

I hereby acknowledge receipt of the above described materials
Debbie Gault Signature Date Received 10-7-10

81 Environmental Tech
13550 N Highway 93
Las Vegas, NV 89165

Ticket Type: INBOUND INVOICE

Ticket Number: 1928
Date: 10/07/2010
Time In: 8:45 am
Time Out: 9:14 am

Customer: 001011 - NGE, LLC c/o Northgate Environ Mgmt

Vehicle/Container: 76984P
Contract: Northgate Env. On Site Soils 3825 11
Comment: 3825-10-11244

Gross Weight: 141,600 LB Scale In
Tare Weight: 54,960 LB Manual Out
Net Weight: 86640 LB
Net Tons: 43.32

BOL: 12018

Origin	Yards	Material	Billing	Quantity
Not Applicable	0.00 YD	SW CONTAMINATED SOIL	43.32	TN

Driver: Julio

Weighmaster: J.M.

IN - WALKERA OUT - MORENOJ

Indemnification. Customer agrees, by signature above, to indemnify, hold harmless, and defend Republic Services, Inc., its subsidiaries, affiliates, employees, officers and directors from and against any and all liabilities, claims, penalties, forfeitures, suits and the costs and expenses incident thereto, including costs of defense, settlement, and reasonable attorney's fees, which may be incurred, as a result of death or injuries to any person, or damage to any property, contamination of or adverse effects on the environment, caused in whole or in part by the Customer, its employees, or subcontractors in disposing waste at this Facility. In the event Customer delivers Unacceptable Waste (as determined by Republic) Customer agrees to assume all expenses and obligations with the removal and/or resolution of any effects caused by the delivery of such Unacceptable Waste.

Indemnización. Cliente acuerda indemnizar, mantener inmune, y defender Republic Services, Inc., sus subsidiarios, compañías, divisiones, empleados, oficiales y directores contra de cualquiera y de todas responsabilidades, demandas, penas, pérdidas, juicios, pleitos y los costos incidente además, incluyendo costos de defensa, de acuerdo judicial, y de honorarios razonables del abogado, que pueden ser incurridos en, o como resultado de, la muerte o herida personal a cualquier persona, o daños a cualquier característica, propiedad, contaminación de la tierra o efectos ilícitos en esta Facilidad, causado entero o en parte por el cliente, sus empleados, o sus subcontratistas en botar basura en esta Facilidad. En el caso que el Cliente entrega, bota, basura (según lo determinado por Republic) en este Establecimiento basura inaceptable en los reglamentos de este Establecimiento, el Cliente se compromete asumir todos los costos y obligaciones con el retiro y/o la resolución de cualquier dano(s) causado por la entrega de tal basura inaceptable.



NON-HAZARDOUS WASTE MANIFEST

MANIFEST # 12018

GENERATOR INFORMATION

Generator Name: Tronox LLC

Address: P.O. Box 55

City: Henderson County: Clark

State: NV Zip: 89009

Site Location (if different): 560 W. Lake Mead

Henderson, NV 89015 (702) 592-7727

CUSTOMER/BILLING INFORMATION

Billing Name: NGE LLC c/o Northgate Environment Management

Address: 300 Frank Ogawa Plaza, Ste 510

City: Oakland County: Alameda

State: CA Zip: 94612

Republic Services Approval #	Description of Waste	Volume/Weight	Expiration Date	Container Type
38251011244	Soil for disposal		12-31-2011	Tractor with Dump Trailer(s)
	RZ- #	43.32 TN		

*Attach Additional Sheet if necessary

I hereby certify that the above-described materials are non-hazardous wastes as defined by 40 CFR 261 or any applicable state law. Further, that the above named materials are properly classified, described, packaged, marked and labeled, and are in proper condition for transportation according to the applicable regulations of the Department of Transportation.

Susan Crowley (Signature) Generator/Authorized Agent Name Date Shipped

TRANSPORTER INFORMATION

Transporter Name: Las Vegas Paving

DOT # 191949

Address: 4420 S. Decatur

Truck Number: 21

Las Vegas, NV 89103

Phone Number: (702) 353-4355

I certify no hazardous waste or other regulated substance was knowingly introduced to the waste while in my custody. The waste transported in this vehicle is the waste identified above, to the best of my knowledge.

Johis Tern (Signature) Date Delivered 10-7-10 Name of Authorized Agent Signature

DISPOSAL SITE INFORMATION

Site Name: Apex Regional Landfill

Phone No. (702) 599-5920

Address: 13550 U.S. Hwy 93 Las Vegas, NV

Juan Moreno (Signature) Date Received 10-7-10 Name (Print or Type) Signature

81 Environmental Tech
13550 N Highway 93
Las Vegas, NV 89165

Ticket Type: INBOUND INVOICE

Ticket Number: 1929
Date: 10/07/2010
Time In: 8:51 am
Time Out: 9:21 am

Customer: 001011 - NGE, LLC c/o Northgate Environ Mgmt

Vehicle/Container: 68954P

Gross Weight: 136,640 LB Manual In
Tare Weight: 54,000 LB Scale Out
Net Weight: 82640 LB
Net Tons: 41.32

Contract: Northgate Env. On Site Soils 3825 11
Comment: 3825-10-11244

BOL: 12019

Origin	Yards	Material	Billing	Quantity
Not Applicable	0.00 YD	SW CONTAMINATED SOIL	41.32	TN

Driver: _____

Weighmaster: _____

IN - WALKERA OUT - MORENOJ

Indemnification. Customer agrees, by signature above, to indemnify, hold harmless, and defend Republic Services, Inc., its subsidiaries, affiliates, employees, officers and directors from and against any and all liabilities, claims, penalties, forfeitures, suits and the costs and expenses incident thereto, including costs of defense, settlement, and reasonable attorney's fees, which may be incurred, as a result of death or injuries to any person, or damage to any property, contamination of or adverse effects on the environment, caused in whole or in part by the Customer, its employees, or subcontractors in disposing waste at this Facility. In the event Customer delivers Unacceptable Waste (as determined by Republic) Customer agrees to assume all expenses and obligations with the removal and/or resolution of any effects caused by the delivery of such Unacceptable Waste.

Indemnización. Cliente acuerda indemnizar, mantener inmune, y defender Republic Services, Inc., sus subsidiarios, compañías, divisiones, empleados, oficiales y directores contra de cualquiera y de todas responsabilidades, demandas, penas, pérdidas, juicios, pleitos y los costos incidente además, incluyendo costos de defensa, de acuerdo judicial, y de honorarios razonables del abogado, que pueden ser incurridos en, o como resultado de, la muerte o herida personal a cualquier persona, o daños a cualquier característica, propiedad, contaminación de la tierra o efectos ilícitos en esta Facilidad, causado entero o en parte por el cliente, sus empleados, o sus subcontratistas en botar basura en esta Facilidad. En el caso que el Cliente entrega, bota, basura (según lo determinado por Republic) en este Establecimiento basura inaceptable en los reglamentos de este Establecimiento, el Cliente se compromete asumir todos los costos y obligaciones con el retiro y/o la resolución de cualquier dano(s) causado por la entrega de tal basura inaceptable.



NON-HAZARDOUS WASTE MANIFEST

MANIFEST # 12019

GENERATOR INFORMATION

Generator Name: Tronox LLC

Address: P.O. Box 55

City: Henderson County: Clark

State: NV Zip: 89009

Site Location (if different): 560 W. Lake Mead

Henderson, NV 89015 (702) 592-7727

CUSTOMER/BILLING INFORMATION

Billing Name: NGE LLC c/o Northgate Environment Management

Address: 300 Frank Ogawa Plaza, Ste 510

City: Oakland County: Alameda

State: CA Zip: 94612

Republic Services Approval #	Description of Waste	Volume/Weight	Expiration Date	Container Type
38251011244	Soil for disposal		12-31-2011	Tractor with Dump Trailer(s)
	RZ- _____ # _____			

*Attach Additional Sheet if necessary

I hereby certify that the above-described materials are non-hazardous wastes as defined by 40 CFR 261 or any applicable state law. Further, that the above named materials are properly classified, described, packaged, marked and labeled, and are in proper condition for transportation according to the applicable regulations of the Department of Transportation.

Susan Crowley (Signature) Generator/Authorized Agent Name Signature Date Shipped

TRANSPORTER INFORMATION

Transporter Name: Las Vegas Paving

DOT # 191949

Address: 4420 S. Decatur

Truck Number: 55

Las Vegas, NV 89103

Phone Number: (702) 353-4355

I certify no hazardous waste or other regulated substance was knowingly introduced to the waste while in my custody. The waste transported in this vehicle is the waste identified above, to the best of my knowledge.

(Signature) Name of Authorized Agent Signature Date Delivered 10-7-10

DISPOSAL SITE INFORMATION

Site Name: Apex Regional Landfill

Phone No. (702) 599-5920

Address: 13550 U.S. Hwy 93 Las Vegas, NV

I hereby acknowledge receipt of the above described materials (Signature) Name (Print or Type) Signature Date Received 10/7/10

81 Environmental Tech
13550 N Highway 93
Las Vegas, NV 89165

Ticket Type: INBOUND INVOICE

Ticket Number: 1930
Date: 10/07/2010
Time In: 8:54 am
Time Out: 9:25 am

Customer: 001011 - NGE, LLC c/o Northgate Environ Mgmt

Vehicle/Container: 71893P
Contract: Northgate Env. On Site Soils 3825 11
Comment: 3825-10-11244 JOHN#7

Gross Weight: 135,360 LB Manual In
Tare Weight: 53,800 LB Manual Out
Net Weight: 81,560 LB
Net Tons: 40.78

BOL: 12020

Origin	Yards	Material	Billing	Quantity
Not Applicable	0.00 YD	SW CONTAMINATED SOIL	40.78	TN

Driver: _____

Weighmaster: _____

IN - WALKERA OUT - MORENOJ

Indemnification. Customer agrees, by signature above, to indemnify, hold harmless, and defend Republic Services, Inc., its subsidiaries, affiliates, employees, officers and directors from and against any and all liabilities, claims, penalties, forfeitures, suits and the costs and expenses incident thereto, including costs of defense, settlement, and reasonable attorney's fees, which may be incurred, as a result of death or injuries to any person, or damage to any property, contamination of or adverse effects on the environment, caused in whole or in part by the Customer, its employees, or subcontractors in disposing waste at this Facility. In the event Customer delivers Unacceptable Waste (as determined by Republic) Customer agrees to assume all expenses and obligations with the removal and/or resolution of any effects caused by the delivery of such Unacceptable Waste.

Indemnización. Cliente acuerda indemnizar, mantener inmune, y defender Republic Services, Inc., sus subsidiarios, compañías, divisiones, empleados, oficiales y directores contra de cualquiera y de todas responsabilidades, demandas, penas, pérdidas, juicios, pleitos y los costos incidente además, incluyendo costos de defensa, de acuerdo judicial, y de honorarios razonables del abogado, que pueden ser incurridos en, o como resultado de, la muerte o herida personal a cualquier persona, o daños a cualquier característica, propiedad, contaminación de la tierra o efectos ilícitos en esta Facilidad, causado entero o en parte por el cliente, sus empleados, o sus subcontratistas en botar basura en esta Facilidad. En el caso que el Cliente entrega, bota, basura (según lo determinado por Republic) en este Establecimiento basura inaceptable en los reglamentos de este Establecimiento, el Cliente se compromete asumir todos los costos y obligaciones con el retiro y/o la resolución de cualquier dano(s) causado por la entrega de tal basura inaceptable.



NON-HAZARDOUS WASTE MANIFEST

MANIFEST # 12020

GENERATOR INFORMATION

Generator Name: Tronox LLC
Address: P.O. Box 55
City: Henderson County: Clark
State: NV Zip: 89009
Site Location (if different): 560 W. Lake Mead
Henderson, NV 89015 (702) 592-7727

CUSTOMER/BILLING INFORMATION

Billing Name: NGE LLC c/o Northgate Environment Management
Address: 300 Frank Ogawa Plaza, Ste 510
City: Oakland County: Alameda
State: CA Zip: 94612

Table with 5 columns: Republic Services Approval #, Description of Waste, Volume/Weight, Expiration Date, Container Type. Row 1: 38251011244, Soil for disposal, 40-78 TN, 12-31-2011, Tractor with Dump Trailer(s).

*Attach Additional Sheet if necessary

I hereby certify that the above-described materials are non-hazardous wastes as defined by 40 CFR 261 or any applicable state law. Further, that the above named materials are properly classified, described, packaged, marked and labeled, and are in proper condition for transportation according to the applicable regulations of the Department of Transportation.

Susan Crowley (Signature)
Generator/Authorized Agent Name Signature Date Shipped

TRANSPORTER INFORMATION

Transporter Name: Las Vegas Paving DOT # 191949
Address: 4420 S. Decatur Truck Number: 7
Las Vegas, NV 89103 Phone Number: (702) 353-4355

I certify no hazardous waste or other regulated substance was knowingly introduced to the waste while in my custody. The waste transported in this vehicle is the waste identified above, to the best of my knowledge.

(Signature)
Name of Authorized Agent Signature Date Delivered 10-7-10

DISPOSAL SITE INFORMATION

Site Name: Apex Regional Landfill Phone No. (702) 599-5920
Address: 13550 U.S. Hwy 93 Las Vegas, NV

I hereby acknowledge receipt of the above described materials
Juan Moreno (Signature)
Name (Print or Type) Signature Date Received 10-7-10

81 Environmental Tech
13550 N Highway 93
Las Vegas, NV 89165

Ticket Type: INBOUND INVOICE

Ticket Number: 1931
Date: 10/07/2010
Time In: 9:31 am
Time Out: 10:05 am

Customer: 001011 - NGE, LLC c/o Northgate Environ Mgmt

Vehicle/Container: 68628P
Contract: Northgate Env. On Site Soils 3825 11
Comment: RH301 3825-10-11244

Gross Weight: 141,660 LB Manual In
Tare Weight: 55,060 LB Manual Out
Net Weight: 86600 LB
Net Tons: 43.30

BOL: 12025

Origin	Yards	Material	Billing	Quantity
Not Applicable	0.00 YD	SW CONTAMINATED SOIL	43.30	TN

Driver: J S →

Weighmaster: [Signature]

IN - WALKERA OUT - GUILFDE

Indemnification. Customer agrees, by signature above, to indemnify, hold harmless, and defend Republic Services, Inc., its subsidiaries, affiliates, employees, officers and directors from and against any and all liabilities, claims, penalties, forfeitures, suits and the costs and expenses incident thereto, including costs of defense, settlement, and reasonable attorney's fees, which may be incurred, as a result of death or injuries to any person, or damage to any property, contamination of or adverse effects on the environment, caused in whole or in part by the Customer, its employees, or subcontractors in disposing waste at this Facility. In the event Customer delivers Unacceptable Waste (as determined by Republic) Customer agrees to assume all expenses and obligations with the removal and/or resolution of any effects caused by the delivery of such Unacceptable Waste.

Indemnización. Cliente acuerda indemnizar, mantener inmune, y defender Republic Services, Inc., sus subsidiarios, compañías, divisiones, empleados, oficiales y directores contra de cualquiera y de todas responsabilidades, demandas, penas, pérdidas, juicios, pleitos y los costos incidente además, incluyendo costos de defensa, de acuerdo judicial, y de honorarios razonables del abogado, que pueden ser incurridos en, o como resultado de, la muerte o herida personal a cualquier persona, o daños a cualquier característica, propiedad, contaminación de la tierra o efectos ilícitos en esta Facilidad, causado entero o en parte por el cliente, sus empleados, o sus subcontratistas en botar basura en esta Facilidad. En el caso que el Cliente entrega, bota, basura (según lo determinado por Republic) en este Establecimiento basura inaceptable en los reglamentos de este Establecimiento, el Cliente se compromete asumir todos los costos y obligaciones con el retiro y/o la resolución de cualquier dano(s) causado por la entrega de tal basura inaceptable.



NON-HAZARDOUS WASTE MANIFEST

MANIFEST # 12025

GENERATOR INFORMATION

Generator Name: Tronox LLC
Address: P.O. Box 55
City: Henderson County: Clark
State: NV Zip: 89009
Site Location (if different): 560 W. Lake Mead
Henderson, NV 89015 (702) 592-7727

CUSTOMER/BILLING INFORMATION

Billing Name: NGE LLC c/o Northgate Environment Management
Address: 300 Frank Ogawa Plaza, Ste 510
City: Oakland County: Alameda
State: CA Zip: 94612

Table with 5 columns: Republic Services Approval #, Description of Waste, Volume/Weight, Expiration Date, Container Type. Row 1: 38251011244, Soil for disposal, 4330 lb, 12-31-2011, Tractor with Dump Trailer(s).

*Attach Additional Sheet if necessary

I hereby certify that the above-described materials are non-hazardous wastes as defined by 40 CFR 261 or any applicable state law. Further, that the above named materials are properly classified, described, packaged, marked and labeled, and are in proper condition for transportation according to the applicable regulations of the Department of Transportation.

Susan Crowley (Signature)
Generator/Authorized Agent Name Signature Date Shipped

TRANSPORTER INFORMATION

Transporter Name: Las Vegas Paving DOT # 191949
Address: 4420 S. Decatur Truck Number: RH301
Las Vegas, NV 89103 Phone Number: (702) 353-4355

I certify no hazardous waste or other regulated substance was knowingly introduced to the waste while in my custody. The waste transported in this vehicle is the waste identified above, to the best of my knowledge.

(Signature)
Name of Authorized Agent Signature Date Delivered 10-7-10

DISPOSAL SITE INFORMATION

Site Name: Apex Regional Landfill Phone No. (702) 599-5920
Address: 13550 U.S. Hwy 93 Las Vegas, NV

I hereby acknowledge receipt of the above described materials
Ariel Drake-Walker (Signature) Ariel D.W. (Signature) 10/7/10
Name (Print or Type) Signature Date Received

81 Environmental Tech
13550 N Highway 93
Las Vegas, NV 89165

Ticket Type: INBOUND INVOICE

Ticket Number: 1932
Date: 10/07/2010
Time In: 9:36 am
Time Out: 10:07 am

Customer: 001011 - NGE, LLC c/o Northgate Environ Mgmt

Vehicle/Container: 85887P
Contract: Northgate Env. On Site Soils 3825 11
Comment: R01 3825-10-11244

Gross Weight: 129,720 LB Manual In
Tare Weight: 52,020 LB Scale Out
Net Weight: 77700 LB
Net Tons: 38.85

BOL: 12023

Origin	Yards	Material	Billing	Quantity
Not Applicable	0.00 YD	SW CONTAMINATED SOIL	38.85	TN

Driver:

Miguel Ramos

Weighmaster:

[Signature]

IN - WALKERA OUT - GUILFDE

Indemnification. Customer agrees, by signature above, to indemnify, hold harmless, and defend Republic Services, Inc., its subsidiaries, affiliates, employees, officers and directors from and against any and all liabilities, claims, penalties, forfeitures, suits and the costs and expenses incident thereto, including costs of defense, settlement, and reasonable attorney's fees, which may be incurred, as a result of death or injuries to any person, or damage to any property, contamination of or adverse effects on the environment, caused in whole or in part by the Customer, its employees, or subcontractors in disposing waste at this Facility. In the event Customer delivers Unacceptable Waste (as determined by Republic) Customer agrees to assume all expenses and obligations with the removal and/or resolution of any effects caused by the delivery of such Unacceptable Waste.

Indemnización. Cliente acuerda indemnizar, mantener inmune, y defender Republic Services, Inc., sus subsidiarios, compañías, divisiones, empleados, oficiales y directores contra de cualquiera y de todas responsabilidades, demandas, penas, pérdidas, juicios, pleitos y los costos incidente además, incluyendo costos de defensa, de acuerdo judicial, y de honorarios razonables del abogado, que pueden ser incurridos en, o como resultado de, la muerte o herida personal a cualquier persona, o daños a cualquier característica, propiedad, contaminación de la tierra o efectos ilícitos en esta Facilidad, causado entero o en parte por el cliente, sus empleados, o sus subcontratistas en botar basura en esta Facilidad. En el caso que el Cliente entrega, bota, basura (según lo determinado por Republic) en este Establecimiento basura inaceptable en los reglamentos de este Establecimiento, el Cliente se compromete asumir todos los costos y obligaciones con el retiro y/o la resolución de cualquier dano(s) causado por la entrega de tal basura inaceptable.



NON-HAZARDOUS WASTE MANIFEST

MANIFEST # 12023

GENERATOR INFORMATION

Generator Name: Tronox LLC

Address: P.O. Box 55

City: Henderson County: Clark

State: NV Zip: 89009

Site Location (if different): 560 W. Lake Mead

Henderson, NV 89015 (702) 592-7727

CUSTOMER/BILLING INFORMATION

Billing Name: NGE LLC c/o Northgate Environment Management

Address: 300 Frank Ogawa Plaza, Ste 510

City: Oakland County: Alameda

State: CA Zip: 94612

Republic Services Approval #	Description of Waste	Volume/Weight	Expiration Date	Container Type
38251011244	Soil for disposal		12-31-2011	Tractor with Dump Trailer(s)
	RZ- _____ # _____	3885		

*Attach Additional Sheet if necessary

I hereby certify that the above-described materials are non-hazardous wastes as defined by 40 CFR 261 or any applicable state law. Further, that the above named materials are properly classified, described, packaged, marked and labeled, and are in proper condition for transportation according to the applicable regulations of the Department of Transportation.

Susan Crowley

Susan Crowley

Generator/Authorized Agent Name

Signature

Date Shipped

TRANSPORTER INFORMATION

Transporter Name: Las Vegas Paving

DOT # 191949

Address: 4420 S. Decatur

Truck Number: 201

Las Vegas, NV 89103

Phone Number: (702) 353-4355

I certify no hazardous waste or other regulated substance was knowingly introduced to the waste while in my custody. The waste transported in this vehicle is the waste identified above, to the best of my knowledge.

[Signature]

10-7-10

Name of Authorized Agent

Signature

Date Delivered

DISPOSAL SITE INFORMATION

Site Name: Apex Regional Landfill

Phone No. (702) 599-5920

Address: 13550 U.S. Hwy 93 Las Vegas, NV

I hereby acknowledge receipt of the above described materials

Debbie Switforle

[Signature]

10-7-10

Name (Print or Type)

Signature

Date Received

81 Environmental Tech
13550 N Highway 93
Las Vegas, NV 89165

Ticket Type: INBOUND INVOICE

Ticket Number: 1933
Date: 10/07/2010
Time In: 9:34 am
Time Out: 10:08 am

Customer: 001011 - NGE, LLC c/o Northgate Environ Mgmt

Vehicle/Container: 85914P
Contract: Northgate Env. On Site Soils 3825 11
Comment: DEC 7 3825-10-11244

Gross Weight: 143,440 LB Manual In
Tare Weight: 54,760 LB Manual Out
Net Weight: 88680 LB
Net Tons: 44.34

12022

Origin	Yards	Material	Billing	Quantity
Not Applicable	0.00 YD	SW CONTAMINATED SOIL	44.34	TN

Driver: 

Weighmaster: 

IN - WALKERA OUT - GUILFDE

Indemnification. Customer agrees, by signature above, to indemnify, hold harmless, and defend Republic Services, Inc., its subsidiaries, affiliates, employees, officers and directors from and against any and all liabilities, claims, penalties, forfeitures, suits and the costs and expenses incident thereto, including costs of defense, settlement, and reasonable attorney's fees, which may be incurred, as a result of death or injuries to any person, or damage to any property, contamination of or adverse effects on the environment, caused in whole or in part by the Customer, its employees, or subcontractors in disposing waste at this Facility. In the event Customer delivers Unacceptable Waste (as determined by Republic) Customer agrees to assume all expenses and obligations with the removal and/or resolution of any effects caused by the delivery of such Unacceptable Waste.

Indemnización. Cliente acuerda indemnizar, mantener inmune, y defender Republic Services, Inc., sus subsidiarios, compañías, divisiones, empleados, oficiales y directores contra de cualquiera y de todas responsabilidades, demandas, penas, pérdidas, juicios, pleitos y los costos incidente además, incluyendo costos de defensa, de acuerdo judicial, y de honorarios razonables del abogado, que pueden ser incurridos en, o como resultado de, la muerte o herida personal a cualquier persona, o daños a cualquier característica, propiedad, contaminación de la tierra o efectos ilícitos en esta Facilidad, causado entero o en parte por el cliente, sus empleados, o sus subcontratistas en botar basura en esta Facilidad. En el caso que el Cliente entrega, bota, basura (según lo determinado por Republic) en este Establecimiento basura inaceptable en los reglamentos de este Establecimiento, el Cliente se compromete asumir todos los costos y obligaciones con el retiro y/o la resolución de cualquier dano(s) causado por la entrega de tal basura inaceptable.



NON-HAZARDOUS WASTE MANIFEST

MANIFEST # 12022

GENERATOR INFORMATION

Generator Name: Tronox LLCAddress: P.O. Box 55City: Henderson County: ClarkState: NV Zip: 89009Site Location (if different): 560 W. Lake Mead
Henderson, NV 89015 (702) 592-7727

CUSTOMER/BILLING INFORMATION

Billing Name: NGE LLC c/o Northgate Environment ManagementAddress: 300 Frank Ogawa Plaza, Ste 510City: Oakland County: AlamedaState: CA Zip: 94612

Republic Services Approval #	Description of Waste	Volume/Weight	Expiration Date	Container Type
38251011244	Soil for disposal		12-31-2011	Tractor with Dump Trailer(s)
	RZ-_____ # _____	44.34		

*Attach Additional Sheet if necessary

I hereby certify that the above-described materials are non-hazardous wastes as defined by 40 CFR 261 or any applicable state law. Further, that the above named materials are properly classified, described, packaged, marked and labeled, and are in proper condition for transportation according to the applicable regulations of the Department of Transportation.

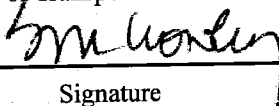
Susan Crowley 
 Generator/Authorized Agent Name Signature Date Shipped

TRANSPORTER INFORMATION

Transporter Name: Las Vegas PavingDOT # 191949Address: 4420 S. DecaturTruck Number: DEC 7Las Vegas, NV 89103Phone Number: (702) 353-4355

I certify no hazardous waste or other regulated substance was knowingly introduced to the waste while in my custody. The waste transported in this vehicle is the waste identified above, to the best of my knowledge.

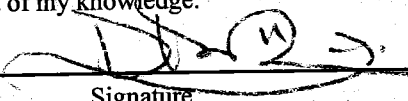
DAVID DELCIB 
 Name of Authorized Agent Signature Date Delivered 10-7-10

DISPOSAL SITE INFORMATION

Site Name: Apex Regional LandfillPhone No. (702) 599-5920Address: 13550 U.S. Hwy 93 Las Vegas, NV

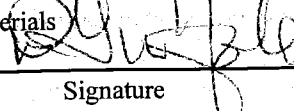
I hereby acknowledge receipt of the above described materials 
Debbie Gault Name (Print or Type) Signature Date Received 10-7-10

81 Environmental Tech
13550 N Highway 93
Las Vegas, NV 89165

Ticket Type: INBOUND INVOICE

Ticket Number: 1934
Date: 10/07/2010
Time In: 9:38 am
Time Out: 10:09 am

Customer: 001011 - NGE, LLC c/o Northgate Environ Mgmt

Vehicle/Container: 44161A
Contract: Northgate Env. On Site Soils 3825 11
Comment: K006-3825-10-11244

Gross Weight: 137,060 LB Manual In
Tare Weight: 55,720 LB Scale Out
Net Weight: 81340 LB
Net Tons: 40.67

BOL: 12021

Origin	Yards	Material	Billing	Quantity
Not Applicable	0.00 YD	SW CONTAMINATED SOIL	40.67	TN

Driver:



Weighmaster:



IN - WALKERA OUT - GUILFDE

Indemnification. Customer agrees, by signature above, to indemnify, hold harmless, and defend Republic Services, Inc., its subsidiaries, affiliates, employees, officers and directors from and against any and all liabilities, claims, penalties, forfeitures, suits and the costs and expenses incident thereto, including costs of defense, settlement, and reasonable attorney's fees, which may be incurred, as a result of death or injuries to any person, or damage to any property, contamination of or adverse effects on the environment, caused in whole or in part by the Customer, its employees, or subcontractors in disposing waste at this Facility. In the event Customer delivers Unacceptable Waste (as determined by Republic) Customer agrees to assume all expenses and obligations with the removal and/or resolution of any effects caused by the delivery of such Unacceptable Waste.

Indemnización. Cliente acuerda indemnizar, mantener inmune, y defender Republic Services, Inc., sus subsidiarios, compañías, divisiones, empleados, oficiales y directores contra de cualquiera y de todas responsabilidades, demandas, penas, pérdidas, juicios, pleitos y los costos incidente además, incluyendo costos de defensa, de acuerdo judicial, y de honorarios razonables del abogado, que pueden ser incurridos en, o como resultado de, la muerte o herida personal a cualquier persona, o daños a cualquier característica, propiedad, contaminación de la tierra o efectos ilícitos en esta Facilidad, causado entero o en parte por el cliente, sus empleados, o sus subcontratistas en botar basura en esta Facilidad. En el caso que el Cliente entrega, bota, basura (según lo determinado por Republic) en este Establecimiento basura inaceptable en los reglamentos de este Establecimiento, el Cliente se compromete asumir todos los costos y obligaciones con el retiro y/o la resolución de cualquier dano(s) causado por la entrega de tal basura inaceptable.



NON-HAZARDOUS WASTE MANIFEST

MANIFEST # 12021

GENERATOR INFORMATION

Generator Name: Tronox LLC

Address: P.O. Box 55

City: Henderson County: Clark

State: NV Zip: 89009

Site Location (if different): 560 W. Lake Mead

Henderson, NV 89015 (702) 592-7727

CUSTOMER/BILLING INFORMATION

Billing Name: NGE LLC c/o Northgate Environment Management

Address: 300 Frank Ogawa Plaza, Ste 510

City: Oakland County: Alameda

State: CA Zip: 94612

Republic Services Approval #	Description of Waste	Volume/Weight	Expiration Date	Container Type
38251011244	Soil for disposal		12-31-2011	Tractor with Dump Trailer(s)
	RZ- #	40.67		

*Attach Additional Sheet if necessary

I hereby certify that the above-described materials are non-hazardous wastes as defined by 40 CFR 261 or any applicable state law. Further, that the above named materials are properly classified, described, packaged, marked and labeled, and are in proper condition for transportation according to the applicable regulations of the Department of Transportation.

Susan Crowley (Signature) Generator/Authorized Agent Name Signature Date Shipped

TRANSPORTER INFORMATION

Transporter Name: Las Vegas Paving

DOT # 191949

Address: 4420 S. Decatur

Truck Number: K-006

Las Vegas, NV 89103

Phone Number: (702) 353-4355

I certify no hazardous waste or other regulated substance was knowingly introduced to the waste while in my custody. The waste transported in this vehicle is the waste identified above, to the best of my knowledge.

Brian Mulvey (Signature) Name of Authorized Agent Signature Date Delivered 10-7-10

DISPOSAL SITE INFORMATION

Site Name: Apex Regional Landfill

Phone No. (702) 599-5920

Address: 13550 U.S. Hwy 93 Las Vegas, NV

Debbie Cuitore (Signature) I hereby acknowledge receipt of the above described materials Name (Print or Type) Signature Date Received 10-7-10

81 Environmental Tech
13550 N Highway 93
Las Vegas, NV 89165

Ticket Type: INBOUND INVOICE

Ticket Number: 1935
Date: 10/07/2010
Time In: 9:54 am
Time Out: 10:24 am

Customer: 001011 - NGE, LLC c/o Northgate Environ Mgmt

Vehicle/Container: Z009877
Contract: Northgate Env. On Site Soils 3825 11
Comment: BROWN 3825-10-11244

Gross Weight: 134,620 LB Manual In
Tare Weight: 48,720 LB Scale Out
Net Weight: 85900 LB
Net Tons: 42.95

BOL: 12026

Origin	Yards	Material	Billing	Quantity
Not Applicable	0.00 YD	SW CONTAMINATED SOIL	42.95	TN

Driver: _____

Weighmaster: _____

IN - WALKERA OUT - GUILFDE

Indemnification. Customer agrees, by signature above, to indemnify, hold harmless, and defend Republic Services, Inc., its subsidiaries, affiliates, employees, officers and directors from and against any and all liabilities, claims, penalties, forfeitures, suits and the costs and expenses incident thereto, including costs of defense, settlement, and reasonable attorney's fees, which may be incurred, as a result of death or injuries to any person, or damage to any property, contamination of or adverse effects on the environment, caused in whole or in part by the Customer, its employees, or subcontractors in disposing waste at this Facility. In the event Customer delivers Unacceptable Waste (as determined by Republic) Customer agrees to assume all expenses and obligations with the removal and/or resolution of any effects caused by the delivery of such Unacceptable Waste.

Indemnización. Cliente acuerda indemnizar, mantener inmune, y defender Republic Services, Inc., sus subsidiarios, compañías, divisiones, empleados, oficiales y directores contra de cualquiera y de todas responsabilidades, demandas, penas, pérdidas, juicios, pleitos y los costos incidente además, incluyendo costos de defensa, de acuerdo judicial, y de honorarios razonables del abogado, que pueden ser incurridos en, o como resultado de, la muerte o herida personal a cualquier persona, o daños a cualquier característica, propiedad, contaminación de la tierra o efectos ilícitos en esta Facilidad, causado entero o en parte por el cliente, sus empleados, o sus subcontratistas en botar basura en esta Facilidad. En el caso que el Cliente entrega, bota, basura (según lo determinado por Republic) en este Establecimiento basura inaceptable en los reglamentos de este Establecimiento, el Cliente se compromete asumir todos los costos y obligaciones con el retiro y/o la resolución de cualquier dano(s) causado por la entrega de tal basura inaceptable.



NON-HAZARDOUS WASTE MANIFEST

MANIFEST # 12026

GENERATOR INFORMATION

Generator Name: Tronox LLCAddress: P.O. Box 55City: Henderson County: ClarkState: NV Zip: 89009Site Location (if different): 560 W. Lake MeadHenderson, NV 89015 (702) 592-7727

CUSTOMER/BILLING INFORMATION

Billing Name: NGE LLC c/o Northgate Environment ManagementAddress: 300 Frank Ogawa Plaza, Ste 510City: Oakland County: AlamedaState: CA Zip: 94612

Republic Services Approval #	Description of Waste	Volume/Weight	Expiration Date	Container Type
38251011244	Soil for disposal		12-31-2011	Tractor with Dump Trailer(s)
	RZ-_____ # _____	42.95		

*Attach Additional Sheet if necessary

I hereby certify that the above-described materials are non-hazardous wastes as defined by 40 CFR 261 or any applicable state law. Further, that the above named materials are properly classified, described, packaged, marked and labeled, and are in proper condition for transportation according to the applicable regulations of the Department of Transportation.

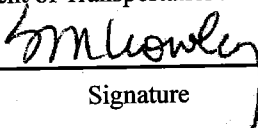
Susan Crowley 
 Generator/Authorized Agent Name Signature Date Shipped

TRANSPORTER INFORMATION

Transporter Name: Las Vegas PavingDOT # 191949Address: 4420 S. DecaturTruck Number: 2010Las Vegas, NV 89103Phone Number: (702) 353-4355

I certify no hazardous waste or other regulated substance was knowingly introduced to the waste while in my custody. The waste transported in this vehicle is the waste identified above, to the best of my knowledge.

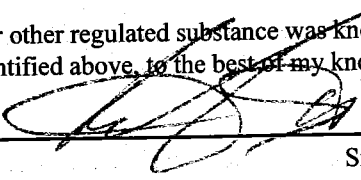
 Name of Authorized Agent Signature Date Delivered 10-7-10

DISPOSAL SITE INFORMATION

Site Name: Apex Regional LandfillPhone No. (702) 599-5920Address: 13550 U.S. Hwy 93 Las Vegas, NV

I hereby acknowledge receipt of the above described materials

 Name (Print or Type) Signature Date Received 10-7-10

81 Environmental Tech
13550 N Highway 93
Las Vegas, NV 89165

Ticket Type: INBOUND INVOICE

Ticket Number: 1936
Date: 10/07/2010
Time In: 10:18 am
Time Out: 10:53 am

Customer: 001011 - NGE, LLC c/o Northgate Environ Mgmt

Vehicle/Container: 44161A
Contract: Northgate Env. On Site Soils 3825 11
Comment: K005 3825-10-11244

Gross Weight: 134,360 LB Manual In
Tare Weight: 52,560 LB Scale Out
Net Weight: 81800 LB
Net Tons: 40.90

Origin	Yards	Material	Billing	Quantity
Not Applicable	0.00 YD	SW CONTAMINATED SOIL	40.90	TN

Driver:

Weighmaster:

IN - WALKERA OUT - GUILFDE

Indemnification. Customer agrees, by signature above, to indemnify, hold harmless, and defend Republic Services, Inc., its subsidiaries, affiliates, employees, officers and directors from and against any and all liabilities, claims, penalties, forfeitures, suits and the costs and expenses incident thereto, including costs of defense, settlement, and reasonable attorney's fees, which may be incurred, as a result of death or injuries to any person, or damage to any property, contamination of or adverse effects on the environment, caused in whole or in part by the Customer, its employees, or subcontractors in disposing waste at this Facility. In the event Customer delivers Unacceptable Waste (as determined by Republic) Customer agrees to assume all expenses and obligations with the removal and/or resolution of any effects caused by the delivery of such Unacceptable Waste.

Indemnización. Cliente acuerda indemnizar, mantener inmune, y defender Republic Services, Inc., sus subsidiarios, compañías, divisiones, empleados, oficiales y directores contra de cualquiera y de todas responsabilidades, demandas, penas, pérdidas, juicios, pleitos y los costos incidente además, incluyendo costos de defensa, de acuerdo judicial, y de honorarios razonables del abogado, que pueden ser incurridos en, o como resultado de, la muerte o herida personal a cualquier persona, o daños a cualquier característica, propiedad, contaminación de la tierra o efectos ilícitos en esta Facilidad, causado entero o en parte por el cliente, sus empleados, o sus subcontratistas en botar basura en esta Facilidad. En el caso que el Cliente entrega, bota, basura (según lo determinado por Republic) en este Establecimiento basura inaceptable en los reglamentos de este Establecimiento, el Cliente se compromete asumir todos los costos y obligaciones con el retiro y/o la resolución de cualquier dano(s) causado por la entrega de tal basura inaceptable.



NON-HAZARDOUS WASTE MANIFEST

MANIFEST # 12024

GENERATOR INFORMATION

Generator Name: Tronox LLC
Address: P.O. Box 55
City: Henderson County: Clark
State: NV Zip: 89009
Site Location (if different): 560 W. Lake Mead
Henderson, NV 89015 (702) 592-7727

CUSTOMER/BILLING INFORMATION

Billing Name: NGE LLC c/o Northgate Environment Management
Address: 300 Frank Ogawa Plaza, Ste 510
City: Oakland County: Alameda
State: CA Zip: 94612

Table with 5 columns: Republic Services Approval #, Description of Waste, Volume/Weight, Expiration Date, Container Type. Row 1: 38251011244, Soil for disposal, 40.90, 12-31-2011, Tractor with Dump Trailer(s).

*Attach Additional Sheet if necessary

I hereby certify that the above-described materials are non-hazardous wastes as defined by 40 CFR 261 or any applicable state law. Further, that the above named materials are properly classified, described, packaged, marked and labeled, and are in proper condition for transportation according to the applicable regulations of the Department of Transportation.

Susan Crowley
Generator/Authorized Agent Name Signature Date Shipped

TRANSPORTER INFORMATION

Transporter Name: Las Vegas Paving DOT # 191949
Address: 4420 S. Decatur Truck Number: K005
Las Vegas, NV 89103 Phone Number: (702) 353-4355

I certify no hazardous waste or other regulated substance was knowingly introduced to the waste while in my custody. The waste transported in this vehicle is the waste identified above, to the best of my knowledge.

Name of Authorized Agent Signature Date Delivered 10-7-10

DISPOSAL SITE INFORMATION

Site Name: Apex Regional Landfill Phone No. (702) 599-5920
Address: 13550 U.S. Hwy 93 Las Vegas, NV

I hereby acknowledge receipt of the above described materials
Debbie Gault Signature Date Received 10-7-10

81 Environmental Tech
13550 N Highway 93
Las Vegas, NV 89165

Ticket Type: INBOUND INVOICE

Ticket Number: 1937
Date: 10/07/2010
Time In: 10:55 am
Time Out: 10:55 am

Customer: 001011 - NGE, LLC c/o Northgate Environ Mgmt

Vehicle/Container: 84893P
Contract: Northgate Env. On Site Soils 3825 11
Comment: 3825 10 11244

Gross Weight: 120,640 LB Manual In
Tare Weight: 55,640 LB Manual Out
Net Weight: 65000 LB
Net Tons: 32.50

BOL: 12027

Origin	Yards	Material	Billing	Quantity
Not Applicable	0.00 YD	SW CONTAMINATED SOIL	32.50	TN

Driver: _____

Weighmaster: _____

GUILFDE

Indemnification. Customer agrees, by signature above, to indemnify, hold harmless, and defend Republic Services, Inc., its subsidiaries, affiliates, employees, officers and directors from and against any and all liabilities, claims, penalties, forfeitures, suits and the costs and expenses incident thereto, including costs of defense, settlement, and reasonable attorney's fees, which may be incurred, as a result of death or injuries to any person, or damage to any property, contamination of or adverse effects on the environment, caused in whole or in part by the Customer, its employees, or subcontractors in disposing waste at this Facility. In the event Customer delivers Unacceptable Waste (as determined by Republic) Customer agrees to assume all expenses and obligations with the removal and/or resolution of any effects caused by the delivery of such Unacceptable Waste.

Indemnización. Cliente acuerda indemnizar, mantener inmune, y defender Republic Services, Inc., sus subsidiarios, compañías, divisiones, empleados, oficiales y directores contra de cualquiera y de todas responsabilidades, demandas, penas, pérdidas, juicios, pleitos y los costos incidente además, incluyendo costos de defensa, de acuerdo judicial, y de honorarios razonables del abogado, que pueden ser incurridos en, o como resultado de, la muerte o herida personal a cualquier persona, o daños a cualquier característica, propiedad, contaminación de la tierra o efectos ilícitos en esta Facilidad, causado entero o en parte por el cliente, sus empleados, o sus subcontratistas en botar basura en esta Facilidad. En el caso que el Cliente entrega, bota, basura (según lo determinado por Republic) en este Establecimiento basura inaceptable en los reglamentos de este Establecimiento, el Cliente se compromete asumir todos los costos y obligaciones con el retiro y/o la resolución de cualquier dano(s) causado por la entrega de tal basura inaceptable.



NON-HAZARDOUS WASTE MANIFEST

MANIFEST # 12027

GENERATOR INFORMATION

Generator Name: Tronox LLC
Address: P.O. Box 55
City: Henderson County: Clark
State: NV Zip: 89009
Site Location (if different): 560 W. Lake Mead
Henderson, NV 89015 (702) 592-7727

CUSTOMER/BILLING INFORMATION

Billing Name: NGE LLC c/o Northgate Environment Management
Address: 300 Frank Ogawa Plaza, Ste 510
City: Oakland County: Alameda
State: CA Zip: 94612

Table with 5 columns: Republic Services Approval #, Description of Waste, Volume/Weight, Expiration Date, Container Type. Row 1: 38251011244, Soil for disposal, 3250, 12-31-2011, Tractor with Dump Trailer(s).

*Attach Additional Sheet if necessary

I hereby certify that the above-described materials are non-hazardous wastes as defined by 40 CFR 261 or any applicable state law. Further, that the above named materials are properly classified, described, packaged, marked and labeled, and are in proper condition for transportation according to the applicable regulations of the Department of Transportation.

Susan Crowley
Generator/Authorized Agent Name Signature Date Shipped

TRANSPORTER INFORMATION

Transporter Name: Las Vegas Paving DOT # 191949
Address: 4420 S. Decatur Truck Number: 303
Las Vegas, NV 89103 Phone Number: (702) 353-4355

I certify no hazardous waste or other regulated substance was knowingly introduced to the waste while in my custody. The waste transported in this vehicle is the waste identified above, to the best of my knowledge.

Name of Authorized Agent Signature Date Delivered

DISPOSAL SITE INFORMATION

Site Name: Apex Regional Landfill Phone No. (702) 599-5920
Address: 13550 U.S. Hwy 93 Las Vegas, NV

Hereby acknowledge receipt of the above described materials
Debbie Gulliford Signature Date Received

81 Environmental Tech
13550 N Highway 93
Las Vegas, NV 89165

Ticket Type: INBOUND INVOICE

Ticket Number: 1938
Date: 10/07/2010
Time In: 10:20 am
Time Out: 10:59 am

Customer: 001011 - NGE, LLC c/o Northgate Environ Mgmt

Vehicle/Container: 29573A
Contract: Northgate Env. On Site Soils 3825 11
Comment: 17 3825-10-11244

Gross Weight: 142,400 LB Manual In
Tare Weight: 57,020 LB Manual Out
Net Weight: 85380 LB
Net Tons: 42.69

BOL: 12030

Origin	Yards	Material-	Billing Quantity
Not Applicable	0.00 YD	SW CONTAMINATED SOIL	42.69 TN

Driver: _____

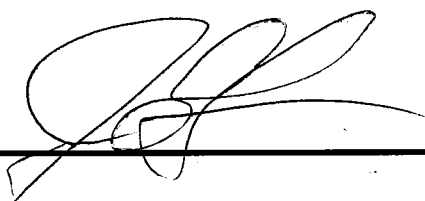

Weighmaster: _____

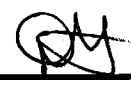

IN - WALKERA OUT - GUILFDE

Indemnification. Customer agrees, by signature above, to indemnify, hold harmless, and defend Republic Services, Inc., its subsidiaries, affiliates, employees, officers and directors from and against any and all liabilities, claims, penalties, forfeitures, suits and the costs and expenses incident thereto, including costs of defense, settlement, and reasonable attorney's fees, which may be incurred, as a result of death or injuries to any person, or damage to any property, contamination of or adverse effects on the environment, caused in whole or in part by the Customer, its employees, or subcontractors in disposing waste at this Facility. In the event Customer delivers Unacceptable Waste (as determined by Republic) Customer agrees to assume all expenses and obligations with the removal and/or resolution of any effects caused by the delivery of such Unacceptable Waste.

Indemnización. Cliente acuerda indemnizar, mantener inmune, y defender Republic Services, Inc., sus subsidiarios, compañías, divisiones, empleados, oficiales y directores contra de cualquiera y de todas responsabilidades, demandas, penas, pérdidas, juicios, pleitos y los costos incidente además, incluyendo costos de defensa, de acuerdo judicial, y de honorarios razonables del abogado, que pueden ser incurridos en, o como resultado de, la muerte o herida personal a cualquier persona, o daños a cualquier característica, propiedad, contaminación de la tierra o efectos ilícitos en esta Facilidad, causado entero o en parte por el cliente, sus empleados, o sus subcontratistas en botar basura en esta Facilidad. En el caso que el Cliente entrega, bota, basura (según lo determinado por Republic) en este Establecimiento basura inaceptable en los reglamentos de este Establecimiento, el Cliente se compromete asumir todos los costos y obligaciones con el retiro y/o la resolución de cualquier dano(s) causado por la entrega de tal basura inaceptable.



NON-HAZARDOUS WASTE MANIFEST

MANIFEST # 12030

GENERATOR INFORMATION

Generator Name: Tronox LLC

Address: P.O. Box 55

City: Henderson County: Clark

State: NV Zip: 89009

Site Location (if different): 560 W. Lake Mead

Henderson, NV 89015 (702) 592-7727

CUSTOMER/BILLING INFORMATION

Billing Name: NGE LLC c/o Northgate Environment Management

Address: 300 Frank Ogawa Plaza, Ste 510

City: Oakland County: Alameda

State: CA Zip: 94612

Republic Services Approval #	Description of Waste	Volume/Weight	Expiration Date	Container Type
38251011244	Soil for disposal		12-31-2011	Tractor with Dump Trailer(s)
	RZ- #	42.69		

*Attach Additional Sheet if necessary

I hereby certify that the above-described materials are non-hazardous wastes as defined by 40 CFR 261 or any applicable state law. Further, that the above named materials are properly classified, described, packaged, marked and labeled, and are in proper condition for transportation according to the applicable regulations of the Department of Transportation.

Susan Crowley
Generator/Authorized Agent Name

Susan Crowley
Signature

10/7/10
Date Shipped

TRANSPORTER INFORMATION

Transporter Name: Las Vegas Paving

DOT # 191949

Address: 4420 S. Decatur

Truck Number: 17

Las Vegas, NV 89103

Phone Number: (702) 353-4355

I certify no hazardous waste or other regulated substance was knowingly introduced to the waste while in my custody. The waste transported in this vehicle is the waste identified above, to the best of my knowledge.

Name of Authorized Agent

[Signature]
Signature

10/7/10
Date Delivered

DISPOSAL SITE INFORMATION

Site Name: Apex Regional Landfill

Phone No. (702) 599-5920

Address: 13550 U.S. Hwy 93 Las Vegas, NV

I hereby acknowledge receipt of the above described materials

Debbie Gault
Name (Print or Type)

Debbie Gault
Signature

10-7-10
Date Received

81 Environmental Tech
13550 N Highway 93
Las Vegas, NV 89165

Ticket Type: INBOUND INVOICE

Ticket Number: 1939
Date: 10/07/2010
Time In: 10:40 am
Time Out: 11:02 am

Customer: 001011 - NGE, LLC c/o Northgate Environ Mgmt

Vehicle/Container: 60573P
Contract: Northgate Env. On Site Soils 3825 11
Comment: 142 3825-10-11244

Gross Weight: 148,780 LB Manual In
Tare Weight: 58,460 LB Scale Out
Net Weight: 90320 LB
Net Tons: 45.16

BOL: 12033

Origin	Yards	Material	Billing	Quantity
Not Applicable	0.00 YD	SW CONTAMINATED SOIL	45.16	TN

Driver: _____



Weighmaster: _____

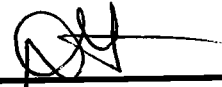

IN - WALKERA OUT - GUILFDE

Indemnification. Customer agrees, by signature above, to indemnify, hold harmless, and defend Republic Services, Inc., its subsidiaries, affiliates, employees, officers and directors from and against any and all liabilities, claims, penalties, forfeitures, suits and the costs and expenses incident thereto, including costs of defense, settlement, and reasonable attorney's fees, which may be incurred, as a result of death or injuries to any person, or damage to any property, contamination of or adverse effects on the environment, caused in whole or in part by the Customer, its employees, or subcontractors in disposing waste at this Facility. In the event Customer delivers Unacceptable Waste (as determined by Republic) Customer agrees to assume all expenses and obligations with the removal and/or resolution of any effects caused by the delivery of such Unacceptable Waste.

Indemnización. Cliente acuerda indemnizar, mantener inmune, y defender Republic Services, Inc., sus subsidiarios, compañías, divisiones, empleados, oficiales y directores contra de cualquiera y de todas responsabilidades, demandas, penas, pérdidas, juicios, pleitos y los costos incidente además, incluyendo costos de defensa, de acuerdo judicial, y de honorarios razonables del abogado, que pueden ser incurridos en, o como resultado de, la muerte o herida personal a cualquier persona, o daños a cualquier característica, propiedad, contaminación de la tierra o efectos ilícitos en esta Facilidad, causado entero o en parte por el cliente, sus empleados, o sus subcontratistas en botar basura en esta Facilidad. En el caso que el Cliente entrega, bota, basura (según lo determinado por Republic) en este Establecimiento basura inaceptable en los reglamentos de este Establecimiento, el Cliente se compromete asumir todos los costos y obligaciones con el retiro y/o la resolución de cualquier dano(s) causado por la entrega de tal basura inaceptable.



NON-HAZARDOUS WASTE MANIFEST

MANIFEST # 12033

GENERATOR INFORMATION

Generator Name: Tronox LLC
Address: P.O. Box 55
City: Henderson County: Clark
State: NV Zip: 89009
Site Location (if different): 560 W. Lake Mead
Henderson, NV 89015 (702) 592-7727

CUSTOMER/BILLING INFORMATION

Billing Name: NGE LLC c/o Northgate Environment Management
Address: 300 Frank Ogawa Plaza, Ste 510
City: Oakland County: Alameda
State: CA Zip: 94612

Table with 5 columns: Republic Services Approval #, Description of Waste, Volume/Weight, Expiration Date, Container Type. Row 1: 38251011244, Soil for disposal, 45.16, 12-31-2011, Tractor with Dump Trailer(s).

*Attach Additional Sheet if necessary

I hereby certify that the above-described materials are non-hazardous wastes as defined by 40 CFR 261 or any applicable state law. Further, that the above named materials are properly classified, described, packaged, marked and labeled, and are in proper condition for transportation according to the applicable regulations of the Department of Transportation.

Susan Crowley (Signature)
Generator/Authorized Agent Name Signature Date Shipped

TRANSPORTER INFORMATION

Transporter Name: Las Vegas Paving DOT # 191949
Address: 4420 S. Decatur Truck Number: 142
Las Vegas, NV 89103 Phone Number: (702) 353-4355

I certify no hazardous waste or other regulated substance was knowingly introduced to the waste while in my custody. The waste transported in this vehicle is the waste identified above, to the best of my knowledge.

(Signature)
Name of Authorized Agent Signature Date Delivered 10-7-10

DISPOSAL SITE INFORMATION

Site Name: Apex Regional Landfill Phone No. (702) 599-5920
Address: 13550 U.S. Hwy 93 Las Vegas, NV

I hereby acknowledge receipt of the above described materials
Debbie Guilloite (Signature)
Name (Print or Type) Signature Date Received 10-7-10

81 Environmental Tech
13550 N Highway 93
Las Vegas, NV 89165

Ticket Type: INBOUND INVOICE

Ticket Number: 1940
Date: 10/07/2010
Time In: 10:28 am
Time Out: 11:04 am

Customer: 001011 - NGE, LLC c/o Northgate Environ Mgmt

Vehicle/Container: 73072P
Contract: Northgate Env. On Site Soils 3825 11
Comment: 135 3825-10-11244

Gross Weight: 142,900 LB Manual In
Tare Weight: 50,960 LB Manual Out
Net Weight: 91940 LB
Net Tons: 45.97

BOL: 12032

Origin	Yards	Material	Billing	Quantity
Not Applicable	0.00 YD	SW CONTAMINATED SOIL	45.97	TN

Driver:



Weighmaster:



IN - WALKERA OUT - GUILFDE

Indemnification. Customer agrees, by signature above, to indemnify, hold harmless, and defend Republic Services, Inc., its subsidiaries, affiliates, employees, officers and directors from and against any and all liabilities, claims, penalties, forfeitures, suits and the costs and expenses incident thereto, including costs of defense, settlement, and reasonable attorney's fees, which may be incurred, as a result of death or injuries to any person, or damage to any property, contamination of or adverse effects on the environment, caused in whole or in part by the Customer, its employees, or subcontractors in disposing waste at this Facility. In the event Customer delivers Unacceptable Waste (as determined by Republic) Customer agrees to assume all expenses and obligations with the removal and/or resolution of any effects caused by the delivery of such Unacceptable Waste.

Indemnización. Cliente acuerda indemnizar, mantener inmune, y defender Republic Services, Inc., sus subsidiarios, compañías, divisiones, empleados, oficiales y directores contra de cualquiera y de todas responsabilidades, demandas, penas, pérdidas, juicios, pleitos y los costos incidente además, incluyendo costos de defensa, de acuerdo judicial, y de honorarios razonables del abogado, que pueden ser incurridos en, o como resultado de, la muerte o herida personal a cualquier persona, o daños a cualquier característica, propiedad, contaminación de la tierra o efectos ilícitos en esta Facilidad, causado entero o en parte por el cliente, sus empleados, o sus subcontratistas en botar basura en esta Facilidad. En el caso que el Cliente entrega, bota, basura (según lo determinado por Republic) en este Establecimiento basura inaceptable en los reglamentos de este Establecimiento, el Cliente se compromete asumir todos los costos y obligaciones con el retiro y/o la resolución de cualquier dano(s) causado por la entrega de tal basura inaceptable.



NON-HAZARDOUS WASTE MANIFEST

MANIFEST # 12032

GENERATOR INFORMATION

Generator Name: Tronox LLC

Address: P.O. Box 55

City: Henderson County: Clark

State: NV Zip: 89009

Site Location (if different): 560 W. Lake Mead
Henderson, NV 89015 (702) 592-7727

CUSTOMER/BILLING INFORMATION

Billing Name: NGE LLC c/o Northgate Environment Management

Address: 300 Frank Ogawa Plaza, Ste 510

City: Oakland County: Alameda

State: CA Zip: 94612

Table with 5 columns: Republic Services Approval #, Description of Waste, Volume/Weight, Expiration Date, Container Type. Row 1: 38251011244, Soil for disposal, 45.97, 12-31-2011, Tractor with Dump Trailer(s).

*Attach Additional Sheet if necessary

I hereby certify that the above-described materials are non-hazardous wastes as defined by 40 CFR 261 or any applicable state law. Further, that the above named materials are properly classified, described, packaged, marked and labeled, and are in proper condition for transportation according to the applicable regulations of the Department of Transportation.

Susan Crowley (Name), [Signature] (Signature), 10-7-10 (Date Shipped)

TRANSPORTER INFORMATION

Transporter Name: Las Vegas Paving

DOT # 191949

Address: 4420 S. Decatur

Truck Number: 135

Las Vegas, NV 89103

Phone Number: (702) 353-4355

I certify no hazardous waste or other regulated substance was knowingly introduced to the waste while in my custody. The waste transported in this vehicle is the waste identified above, to the best of my knowledge.

Robert Lee (Name), [Signature] (Signature), 10-7-10 (Date Delivered)

DISPOSAL SITE INFORMATION

Site Name: Apex Regional Landfill

Phone No. (702) 599-5920

Address: 13550 U.S. Hwy 93 Las Vegas, NV

I hereby acknowledge receipt of the above described materials

Debbie Fults (Name), [Signature] (Signature), 10-7-10 (Date Received)

81 Environmental Tech
13550 N Highway 93
Las Vegas, NV 89165

Ticket Type: INBOUND INVOICE

Ticket Number: 1941
Date: 10/07/2010
Time In: 10:36 am
Time Out: 11:07 am

Customer: 001011 - NGE, LLC c/o Northgate Environ Mgmt

Vehicle/Container: 81494P
Contract: Northgate Env. On Site Soils 3825 11
Comment: 3825-10-11244

Gross Weight: 115,700 LB Manual In
Tare Weight: 51,020 LB Manual Out
Net Weight: 64680 LB
Net Tons: 32.34

BOL: 12034

Origin	Yards	Material	Billing	Quantity
Not Applicable	0.00 YD	SW CONTAMINATED SOIL	32.34	TN

Driver: _____

Weighmaster: _____

GUILFDE

Indemnification. Customer agrees, by signature above, to indemnify, hold harmless, and defend Republic Services, Inc., its subsidiaries, affiliates, employees, officers and directors from and against any and all liabilities, claims, penalties, forfeitures, suits and the costs and expenses incident thereto, including costs of defense, settlement, and reasonable attorney's fees, which may be incurred, as a result of death or injuries to any person, or damage to any property, contamination of or adverse effects on the environment, caused in whole or in part by the Customer, its employees, or subcontractors in disposing waste at this Facility. In the event Customer delivers Unacceptable Waste (as determined by Republic) Customer agrees to assume all expenses and obligations with the removal and/or resolution of any effects caused by the delivery of such Unacceptable Waste.

Indemnización. Cliente acuerda indemnizar, mantener inmune, y defender Republic Services, Inc., sus subsidiarios, compañías, divisiones, empleados, oficiales y directores contra de cualquiera y de todas responsabilidades, demandas, penas, pérdidas, juicios, pleitos y los costos incidente además, incluyendo costos de defensa, de acuerdo judicial, y de honorarios razonables del abogado, que pueden ser incurridos en, o como resultado de, la muerte o herida personal a cualquier persona, o daños a cualquier característica, propiedad, contaminación de la tierra o efectos ilícitos en esta Facilidad, causado entero o en parte por el cliente, sus empleados, o sus subcontratistas en botar basura en esta Facilidad. En el caso que el Cliente entrega, bota, basura (según lo determinado por Republic) en este Establecimiento basura inaceptable en los reglamentos de este Establecimiento, el Cliente se compromete asumir todos los costos y obligaciones con el retiro y/o la resolución de cualquier dano(s) causado por la entrega de tal basura inaceptable.



NON-HAZARDOUS WASTE MANIFEST

MANIFEST # 12034

GENERATOR INFORMATION

Generator Name: Tronox LLC

Address: P.O. Box 55

City: Henderson County: Clark

State: NV Zip: 89009

Site Location (if different): 560 W. Lake Mead

Henderson, NV 89015 (702) 592-7727

CUSTOMER/BILLING INFORMATION

Billing Name: NGE LLC c/o Northgate Environment Management

Address: 300 Frank Ogawa Plaza, Ste 510

City: Oakland County: Alameda

State: CA Zip: 94612

Republic Services Approval #	Description of Waste	Volume/Weight	Expiration Date	Container Type
38251011244	Soil for disposal		12-31-2011	Tractor with Dump Trailer(s)
	RZ- #	32.24		

*Attach Additional Sheet if necessary

I hereby certify that the above-described materials are non-hazardous wastes as defined by 40 CFR 261 or any applicable state law. Further, that the above named materials are properly classified, described, packaged, marked and labeled, and are in proper condition for transportation according to the applicable regulations of the Department of Transportation.

Susan Crowley (Signature) Generator/Authorized Agent Name Date Shipped

TRANSPORTER INFORMATION

Transporter Name: Las Vegas Paving

DOT # 191949

Address: 4420 S. Decatur

Truck Number: 125

Las Vegas, NV 89103

Phone Number: (702) 353-4355

I certify no hazardous waste or other regulated substance was knowingly introduced to the waste while in my custody. The waste transported in this vehicle is the waste identified above, to the best of my knowledge.

J. Buegel (Signature) Name of Authorized Agent Date Delivered 10-7-10

DISPOSAL SITE INFORMATION

Site Name: Apex Regional Landfill

Phone No. (702) 599-5920

Address: 13550 U.S. Hwy 93 Las Vegas, NV

I hereby acknowledge receipt of the above described materials (Signature) Name (Print or Type) Date Received 10-7-10

81 Environmental Tech
13550 N Highway 93
Las Vegas, NV 89165

Ticket Type: INBOUND INVOICE

Ticket Number: 1942
Date: 10/07/2010
Time In: 10:43 am
Time Out: 11:10 am

Customer: 001011 - NGE, LLC c/o Northgate Environ Mgmt

Vehicle/Container: 72010P
Contract: Northgate Env. On Site Soils 3825 11
Comment: 97 3825-10-11244

Gross Weight: 142,300 LB Scale In
Tare Weight: 53,200 LB Scale Out
Net Weight: 89,100 LB
Net Tons: 44.55

BOL: 12029

Origin	Yards	Material	Billing	Quantity
Not Applicable	0.00 YD	SW CONTAMINATED SOIL	44.55	TN

Driver: _____

Weighmaster: _____

IN - WALKERA OUT - GUILFDE

Indemnification. Customer agrees, by signature above, to indemnify, hold harmless, and defend Republic Services, Inc., its subsidiaries, affiliates, employees, officers and directors from and against any and all liabilities, claims, penalties, forfeitures, suits and the costs and expenses incident thereto, including costs of defense, settlement, and reasonable attorney's fees, which may be incurred, as a result of death or injuries to any person, or damage to any property, contamination of or adverse effects on the environment, caused in whole or in part by the Customer, its employees, or subcontractors in disposing waste at this Facility. In the event Customer delivers Unacceptable Waste (as determined by Republic) Customer agrees to assume all expenses and obligations with the removal and/or resolution of any effects caused by the delivery of such Unacceptable Waste.

Indemnización. Cliente acuerda indemnizar, mantener inmune, y defender Republic Services, Inc., sus subsidiarios, compañías, divisiones, empleados, oficiales y directores contra de cualquiera y de todas responsabilidades, demandas, penas, pérdidas, juicios, pleitos y los costos incidente además, incluyendo costos de defensa, de acuerdo judicial, y de honorarios razonables del abogado, que pueden ser incurridos en, o como resultado de, la muerte o herida personal a cualquier persona, o daños a cualquier característica, propiedad, contaminación de la tierra o efectos ilícitos en esta Facilidad, causado entero o en parte por el cliente, sus empleados, o sus subcontratistas en botar basura en esta Facilidad. En el caso que el Cliente entrega, bota, basura (según lo determinado por Republic) en este Establecimiento basura inaceptable en los reglamentos de este Establecimiento, el Cliente se compromete asumir todos los costos y obligaciones con el retiro y/o la resolución de cualquier dano(s) causado por la entrega de tal basura inaceptable.



NON-HAZARDOUS WASTE MANIFEST

MANIFEST # 12029

GENERATOR INFORMATION

Generator Name: Tronox LLC
Address: P.O. Box 55
City: Henderson County: Clark
State: NV Zip: 89009
Site Location (if different): 560 W. Lake Mead
Henderson, NV 89015 (702) 592-7727

CUSTOMER/BILLING INFORMATION

Billing Name: NGE LLC c/o Northgate Environment Management
Address: 300 Frank Ogawa Plaza, Ste 510
City: Oakland County: Alameda
State: CA Zip: 94612

Table with 5 columns: Republic Services Approval #, Description of Waste, Volume/Weight, Expiration Date, Container Type. Row 1: 38251011244, Soil for disposal, 44.55, 12-31-2011, Tractor with Dump Trailer(s).

*Attach Additional Sheet if necessary

I hereby certify that the above-described materials are non-hazardous wastes as defined by 40 CFR 261 or any applicable state law. Further, that the above named materials are properly classified, described, packaged, marked and labeled, and are in proper condition for transportation according to the applicable regulations of the Department of Transportation.

Susan Crowley (Signature)
Generator/Authorized Agent Name Signature Date Shipped

TRANSPORTER INFORMATION

Transporter Name: Las Vegas Paving DOT # 191949
Address: 4420 S. Decatur Truck Number: 97
Las Vegas, NV 89103 Phone Number: (702) 353-4355

I certify no hazardous waste or other regulated substance was knowingly introduced to the waste while in my custody. The waste transported in this vehicle is the waste identified above, to the best of my knowledge.

(Signature)
Name of Authorized Agent Signature Date Delivered 10-7-10

DISPOSAL SITE INFORMATION

Site Name: Apex Regional Landfill Phone No. (702) 599-5920
Address: 13550 U.S. Hwy 93 Las Vegas, NV

Debbie Switzer (Signature)
Name (Print or Type) Signature Date Received 10-7-10

81 Environmental Tech
13550 N Highway 93
Las Vegas, NV 89165

Ticket Type: INBOUND INVOICE

Ticket Number: 1943
Date: 10/07/2010
Time In: 10:41 am
Time Out: 11:12 am

Customer: 001011 - NGE, LLC c/o Northgate Environ Mgmt

Vehicle/Container: 64739P
Contract: Northgate Env. On Site Soils 3825 11
Comment: 106 3825-10-11244

Gross Weight: 133,400 LB Scale In
Tare Weight: 52,080 LB Manual Out
Net Weight: 81320 LB
Net Tons: 40.66

BOL: 12028

Origin	Yards	Material	Billing	Quantity
Not Applicable	0.00 YD	SW CONTAMINATED SOIL	40.66	TN

Driver: _____



Weighmaster: _____

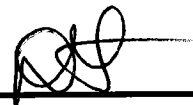

IN - WALKERA OUT - GUILFDE

Indemnification. Customer agrees, by signature above, to indemnify, hold harmless, and defend Republic Services, Inc., its subsidiaries, affiliates, employees, officers and directors from and against any and all liabilities, claims, penalties, forfeitures, suits and the costs and expenses incident thereto, including costs of defense, settlement, and reasonable attorney's fees, which may be incurred, as a result of death or injuries to any person, or damage to any property, contamination of or adverse effects on the environment, caused in whole or in part by the Customer, its employees, or subcontractors in disposing waste at this Facility. In the event Customer delivers Unacceptable Waste (as determined by Republic) Customer agrees to assume all expenses and obligations with the removal and/or resolution of any effects caused by the delivery of such Unacceptable Waste.

Indemnización. Cliente acuerda indemnizar, mantener inmune, y defender Republic Services, Inc., sus subsidiarios, compañías, divisiones, empleados, oficiales y directores contra de cualquiera y de todas responsabilidades, demandas, penas, pérdidas, juicios, pleitos y los costos incidente además, incluyendo costos de defensa, de acuerdo judicial, y de honorarios razonables del abogado, que pueden ser incurridos en, o como resultado de, la muerte o herida personal a cualquier persona, o daños a cualquier característica, propiedad, contaminación de la tierra o efectos ilícitos en esta Facilidad, causado entero o en parte por el cliente, sus empleados, o sus subcontratistas en botar basura en esta Facilidad. En el caso que el Cliente entrega, bota, basura (según lo determinado por Republic) en este Establecimiento basura inaceptable en los reglamentos de este Establecimiento, el Cliente se compromete asumir todos los costos y obligaciones con el retiro y/o la resolución de cualquier dano(s) causado por la entrega de tal basura inaceptable.



NON-HAZARDOUS WASTE MANIFEST

MANIFEST # 12028

GENERATOR INFORMATION

Generator Name: Tronox LLC

Address: P.O. Box 55

City: Henderson County: Clark

State: NV Zip: 89009

Site Location (if different): 560 W. Lake Mead

Henderson, NV 89015 (702) 592-7727

CUSTOMER/BILLING INFORMATION

Billing Name: NGE LLC c/o Northgate Environment Management

Address: 300 Frank Ogawa Plaza, Ste 510

City: Oakland County: Alameda

State: CA Zip: 94612

Republic Services Approval #	Description of Waste	Volume/Weight	Expiration Date	Container Type
38251011244	Soil for disposal		12-31-2011	Tractor with Dump Trailer(s)
	RZ- #	40.66		

*Attach Additional Sheet if necessary

I hereby certify that the above-described materials are non-hazardous wastes as defined by 40 CFR 261 or any applicable state law. Further, that the above named materials are properly classified, described, packaged, marked and labeled, and are in proper condition for transportation according to the applicable regulations of the Department of Transportation.

Susan Crowley Generator/Authorized Agent Name; Tom Crowley Signature; Date Shipped

TRANSPORTER INFORMATION

Transporter Name: Las Vegas Paving

DOT # 191949

Address: 4420 S. Decatur

Truck Number: 106

Las Vegas, NV 89103

Phone Number: (702) 353-4355

I certify no hazardous waste or other regulated substance was knowingly introduced to the waste while in my custody. The waste transported in this vehicle is the waste identified above, to the best of my knowledge.

Name of Authorized Agent; Signature; Date Delivered: 10.7.10

DISPOSAL SITE INFORMATION

Site Name: Apex Regional Landfill

Phone No. (702) 599-5920

Address: 13550 U.S. Hwy 93 Las Vegas, NV

I hereby acknowledge receipt of the above described materials; Name (Print or Type); Signature; Date Received: 10-7-10

81 Environmental Tech
13550 N Highway 93
Las Vegas, NV 89165

Ticket Type: INBOUND INVOICE

Ticket Number: 1944
Date: 10/07/2010
Time In: 10:44 am
Time Out: 11:15 am

Customer: 001011 - NGE, LLC c/o Northgate Environ Mgmt

Vehicle/Container: 81496P
Contract: Northgate Env. On Site Soils 3825 11
Comment: 145 3825-10-11244

Gross Weight: 118,200 LB Manual In
Tare Weight: 50,400 LB Manual Out
Net Weight: 67800 LB
Net Tons: 33.90

BOL: 12035

Origin	Yards	Material	Billing	Quantity
Not Applicable	0.00 YD	SW CONTAMINATED SOIL	33.90	TN

Driver: _____

Weighmaster: _____

IN - WALKERA OUT - GUILFDE

Indemnification. Customer agrees, by signature above, to indemnify, hold harmless, and defend Republic Services, Inc., its subsidiaries, affiliates, employees, officers and directors from and against any and all liabilities, claims, penalties, forfeitures, suits and the costs and expenses incident thereto, including costs of defense, settlement, and reasonable attorney's fees, which may be incurred, as a result of death or injuries to any person, or damage to any property, contamination of or adverse effects on the environment, caused in whole or in part by the Customer, its employees, or subcontractors in disposing waste at this Facility. In the event Customer delivers Unacceptable Waste (as determined by Republic) Customer agrees to assume all expenses and obligations with the removal and/or resolution of any effects caused by the delivery of such Unacceptable Waste.

Indemnización. Cliente acuerda indemnizar, mantener inmune, y defender Republic Services, Inc., sus subsidiarios, compañías, divisiones, empleados, oficiales y directores contra de cualquiera y de todas responsabilidades, demandas, penas, pérdidas, juicios, pleitos y los costos incidente además, incluyendo costos de defensa, de acuerdo judicial, y de honorarios razonables del abogado, que pueden ser incurridos en, o como resultado de, la muerte o herida personal a cualquier persona, o daños a cualquier característica, propiedad, contaminación de la tierra o efectos ilícitos en esta Facilidad, causado entero o en parte por el cliente, sus empleados, o sus subcontratistas en botar basura en esta Facilidad. En el caso que el Cliente entrega, bota, basura (según lo determinado por Republic) en este Establecimiento basura inaceptable en los reglamentos de este Establecimiento, el Cliente se compromete asumir todos los costos y obligaciones con el retiro y/o la resolución de cualquier dano(s) causado por la entrega de tal basura inaceptable.



NON-HAZARDOUS WASTE MANIFEST

MANIFEST # 12035

GENERATOR INFORMATION

Generator Name: Tronox LLC

Address: P.O. Box 55

City: Henderson County: Clark

State: NV Zip: 89009

Site Location (if different): 560 W. Lake Mead

Henderson, NV 89015 (702) 592-7727

CUSTOMER/BILLING INFORMATION

Billing Name: NGE LLC c/o Northgate Environment Management

Address: 300 Frank Ogawa Plaza, Ste 510

City: Oakland County: Alameda

State: CA Zip: 94612

Republic Services Approval #	Description of Waste	Volume/Weight	Expiration Date	Container Type
38251011244	Soil for disposal		12-31-2011	Tractor with Dump Trailer(s)
	RZ- _____ # _____	3390		

*Attach Additional Sheet if necessary

I hereby certify that the above-described materials are non-hazardous wastes as defined by 40 CFR 261 or any applicable state law. Further, that the above named materials are properly classified, described, packaged, marked and labeled, and are in proper condition for transportation according to the applicable regulations of the Department of Transportation.

Susan Crowley Generator/Authorized Agent Name Signature Date Shipped

TRANSPORTER INFORMATION

Transporter Name: Las Vegas Paving

DOT # 191949

Address: 4420 S. Decatur

Truck Number: 145

Las Vegas, NV 89103

Phone Number: (702) 353-4355

I certify no hazardous waste or other regulated substance was knowingly introduced to the waste while in my custody. The waste transported in this vehicle is the waste identified above, to the best of my knowledge.

Name of Authorized Agent Signature Date Delivered 10.7.10

DISPOSAL SITE INFORMATION

Site Name: Apex Regional Landfill

Phone No. (702) 599-5920

Address: 13550 U.S. Hwy 93 Las Vegas, NV

I hereby acknowledge receipt of the above described materials Name (Print or Type) Signature Date Received 10-7-10

81 Environmental Tech
13550 N Highway 93
Las Vegas, NV 89165

Ticket Type: INBOUND INVOICE

Ticket Number: 1945
Date: 10/07/2010
Time In: 10:46 am
Time Out: 11:16 am

Customer: 001011 - NGE, LLC c/o Northgate Environ Mgmt

Vehicle/Container: 81495P
Contract: Northgate Env. On Site Soils 3825 11
Comment: 175 3825-10-11244

Gross Weight: 111,420 LB Manual In
Tare Weight: 51,240 LB Manual Out
Net Weight: 60180 LB
Net Tons: 30.09

BOL: 12031

Origin	Yards	Material	Billing	Quantity
Not Applicable	0.00 YD	SW CONTAMINATED SOIL	30.09	TN

Driver: _____



Weighmaster: _____



IN - WALKERA OUT - GUILFDE

Indemnification. Customer agrees, by signature above, to indemnify, hold harmless, and defend Republic Services, Inc., its subsidiaries, affiliates, employees, officers and directors from and against any and all liabilities, claims, penalties, forfeitures, suits and the costs and expenses incident thereto, including costs of defense, settlement, and reasonable attorney's fees, which may be incurred, as a result of death or injuries to any person, or damage to any property, contamination of or adverse effects on the environment, caused in whole or in part by the Customer, its employees, or subcontractors in disposing waste at this Facility. In the event Customer delivers Unacceptable Waste (as determined by Republic) Customer agrees to assume all expenses and obligations with the removal and/or resolution of any effects caused by the delivery of such Unacceptable Waste.

Indemnización. Cliente acuerda indemnizar, mantener inmune, y defender Republic Services, Inc., sus subsidiarios, compañías, divisiones, empleados, oficiales y directores contra de cualquiera y de todas responsabilidades, demandas, penas, pérdidas, juicios, pleitos y los costos incidente además, incluyendo costos de defensa, de acuerdo judicial, y de honorarios razonables del abogado, que pueden ser incurridos en, o como resultado de, la muerte o herida personal a cualquier persona, o daños a cualquier característica, propiedad, contaminación de la tierra o efectos ilícitos en esta Facilidad, causado entero o en parte por el cliente, sus empleados, o sus subcontratistas en botar basura en esta Facilidad. En el caso que el Cliente entrega, bota, basura (según lo determinado por Republic) en este Establecimiento basura inaceptable en los reglamentos de este Establecimiento, el Cliente se compromete asumir todos los costos y obligaciones con el retiro y/o la resolución de cualquier dano(s) causado por la entrega de tal basura inaceptable.



SK 40237

NON-HAZARDOUS WASTE MANIFEST

MANIFEST # 12031

GENERATOR INFORMATION

Generator Name: Tronox LLC

Address: P.O. Box 55

City: Henderson County: Clark

State: NV Zip: 89009

Site Location (if different): 560 W. Lake Mead

Henderson, NV 89015 (702) 592-7727

CUSTOMER/BILLING INFORMATION

Billing Name: NGE LLC c/o Northgate Environment Management

Address: 300 Frank Ogawa Plaza, Ste 510

City: Oakland County: Alameda

State: CA Zip: 94612

Republic Services Approval #	Description of Waste	Volume/Weight	Expiration Date	Container Type
38251011244	Soil for disposal		12-31-2011	Tractor with Dump Trailer(s)
	RZ- #	3009		

*Attach Additional Sheet if necessary

I hereby certify that the above-described materials are non-hazardous wastes as defined by 40 CFR 261 or any applicable state law. Further, that the above named materials are properly classified, described, packaged, marked and labeled, and are in proper condition for transportation according to the applicable regulations of the Department of Transportation.

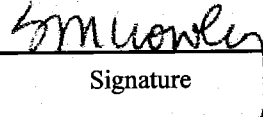
Susan Crowley 
 Generator/Authorized Agent Name Signature Date Shipped

TRANSPORTER INFORMATION

Transporter Name: Las Vegas Paving

DOT # 191949

Address: 4420 S. Decatur

Truck Number: 175

Las Vegas, NV 89103

Phone Number: (702) 353-4355

I certify no hazardous waste or other regulated substance was knowingly introduced to the waste while in my custody. The waste transported in this vehicle is the waste identified above, to the best of my knowledge.

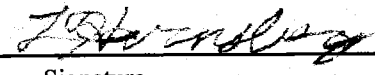
Larry Harnsberger 
 Name of Authorized Agent Signature Date Delivered 10-7-10

DISPOSAL SITE INFORMATION

Site Name: Apex Regional Landfill

Phone No. (702) 599-5920

Address: 13550 U.S. Hwy 93 Las Vegas, NV

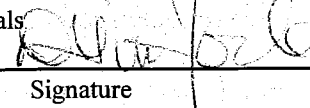
I hereby acknowledge receipt of the above described materials
Debbie Gault 
 Name (Print or Type) Signature Date Received 10-7-10

81 Environmental Tech
13550 N Highway 93
Las Vegas, NV 89165

Ticket Type: INBOUND INVOICE

Ticket Number: 1946
Date: 10/07/2010
Time In: 10:56 am
Time Out: 11:21 am

Customer: 001011 - NGE, LLC c/o Northgate Environ Mgmt

Vehicle/Container: 76953P
Contract: Northgate Env. On Site Soils 3825 11
Comment: JN 21 3825-10-11244

Gross Weight: 137,540 LB Manual In
Tare Weight: 54,660 LB Scale Out
Net Weight: 82880 LB
Net Tons: 41.44

BOL: 12036

Origin	Yards	Material	Billing	Quantity
Not Applicable	0.00 YD	SW CONTAMINATED SOIL	41.44	TN

Driver: Julio

Weighmaster: [Signature]

IN - walkera OUT - GUILFDE

Indemnification. Customer agrees, by signature above, to indemnify, hold harmless, and defend Republic Services, Inc., its subsidiaries, affiliates, employees, officers and directors from and against any and all liabilities, claims, penalties, forfeitures, suits and the costs and expenses incident thereto, including costs of defense, settlement, and reasonable attorney's fees, which may be incurred, as a result of death or injuries to any person, or damage to any property, contamination of or adverse effects on the environment, caused in whole or in part by the Customer, its employees, or subcontractors in disposing waste at this Facility. In the event Customer delivers Unacceptable Waste (as determined by Republic) Customer agrees to assume all expenses and obligations with the removal and/or resolution of any effects caused by the delivery of such Unacceptable Waste.

Indemnización. Cliente acuerda indemnizar, mantener inmune, y defender Republic Services, Inc., sus subsidiarios, compañías, divisiones, empleados, oficiales y directores contra de cualquiera y de todas responsabilidades, demandas, penas, pérdidas, juicios, pleitos y los costos incidente además, incluyendo costos de defensa, de acuerdo judicial, y de honorarios razonables del abogado, que pueden ser incurridos en, o como resultado de, la muerte o herida personal a cualquier persona, o daños a cualquier característica, propiedad, contaminación de la tierra o efectos ilícitos en esta Facilidad, causado entero o en parte por el cliente, sus empleados, o sus subcontratistas en botar basura en esta Facilidad. En el caso que el Cliente entrega, bota, basura (según lo determinado por Republic) en este Establecimiento basura inaceptable en los reglamentos de este Establecimiento, el Cliente se compromete asumir todos los costos y obligaciones con el retiro y/o la resolución de cualquier dano(s) causado por la entrega de tal basura inaceptable.



NON-HAZARDOUS WASTE MANIFEST

MANIFEST # 12036

GENERATOR INFORMATION

Generator Name: Tronox LLC

Address: P.O. Box 55

City: Henderson County: Clark

State: NV Zip: 89009

Site Location (if different): 560 W. Lake Mead

Henderson, NV 89015 (702) 592-7727

CUSTOMER/BILLING INFORMATION

Billing Name: NGE LLC c/o Northgate Environment Management

Address: 300 Frank Ogawa Plaza, Ste 510

City: Oakland County: Alameda

State: CA Zip: 94612

Republic Services Approval #	Description of Waste	Volume/Weight	Expiration Date	Container Type
38251011244	Soil for disposal		12-31-2011	Tractor with Dump Trailer(s)
	RZ- #	41,44		

*Attach Additional Sheet if necessary

I hereby certify that the above-described materials are non-hazardous wastes as defined by 40 CFR 261 or any applicable state law. Further, that the above named materials are properly classified, described, packaged, marked and labeled, and are in proper condition for transportation according to the applicable regulations of the Department of Transportation.

Susan Crowley (Signature) Date Shipped

TRANSPORTER INFORMATION

Transporter Name: Las Vegas Paving

DOT # 191949

Address: 4420 S. Decatur

Truck Number: 21

Las Vegas, NV 89103

Phone Number: (702) 353-4355

I certify no hazardous waste or other regulated substance was knowingly introduced to the waste while in my custody. The waste transported in this vehicle is the waste identified above, to the best of my knowledge.

Julio (Signature) Date Delivered 10-7-10

DISPOSAL SITE INFORMATION

Site Name: Apex Regional Landfill

Phone No. (702) 599-5920

Address: 13550 U.S. Hwy 93 Las Vegas, NV

I hereby acknowledge receipt of the above described materials. Debrae Caulfield (Signature) Date Received 10-7-10

81 Environmental Tech
13550 N Highway 93
Las Vegas, NV 89165

Ticket Type: INBOUND INVOICE

Ticket Number: 1947
Date: 10/07/2010
Time In: 11:11 am
Time Out: 11:38 am

Customer: 001011 - NGE, LLC c/o Northgate Environ Mgmt

Vehicle/Container: 66954P
Contract: Northgate Env. On Site Soils 3825 11
Comment: 55 3825-10-11244

Gross Weight: 131,860 LB Manual In
Tare Weight: 53,860 LB Scale Out
Net Weight: 78000 LB
Net Tons: 39.00

BOL: 12037

Origin	Yards	Material	Billing	Quantity
Not Applicable	0.00 YD	SW CONTAMINATED SOIL	39.00	TN

Driver:



Weighmaster:



IN - walkera OUT - MORENOJ

Indemnification. Customer agrees, by signature above, to indemnify, hold harmless, and defend Republic Services, Inc., its subsidiaries, affiliates, employees, officers and directors from and against any and all liabilities, claims, penalties, forfeitures, suits and the costs and expenses incident thereto, including costs of defense, settlement, and reasonable attorney's fees, which may be incurred, as a result of death or injuries to any person, or damage to any property, contamination of or adverse effects on the environment, caused in whole or in part by the Customer, its employees, or subcontractors in disposing waste at this Facility. In the event Customer delivers Unacceptable Waste (as determined by Republic) Customer agrees to assume all expenses and obligations with the removal and/or resolution of any effects caused by the delivery of such Unacceptable Waste.

Indemnización. Cliente acuerda indemnizar, mantener inmune, y defender Republic Services, Inc., sus subsidiarios, compañías, divisiones, empleados, oficiales y directores contra de cualquiera y de todas responsabilidades, demandas, penas, pérdidas, juicios, pleitos y los costos incidente además, incluyendo costos de defensa, de acuerdo judicial, y de honorarios razonables del abogado, que pueden ser incurridos en, o como resultado de, la muerte o herida personal a cualquier persona, o daños a cualquier característica, propiedad, contaminación de la tierra o efectos ilícitos en esta Facilidad, causado entero o en parte por el cliente, sus empleados, o sus subcontratistas en botar basura en esta Facilidad. En el caso que el Cliente entrega, bota, basura (según lo determinado por Republic) en este Establecimiento basura inaceptable en los reglamentos de este Establecimiento, el Cliente se compromete asumir todos los costos y obligaciones con el retiro y/o la resolución de cualquier dano(s) causado por la entrega de tal basura inaceptable.



NON-HAZARDOUS WASTE MANIFEST

MANIFEST # 12037

GENERATOR INFORMATION

Generator Name: Tronox LLC
Address: P.O. Box 55
City: Henderson County: Clark
State: NV Zip: 89009
Site Location (if different): 560 W. Lake Mead
Henderson, NV 89015 (702) 592-7727

CUSTOMER/BILLING INFORMATION

Billing Name: NGE LLC c/o Northgate Environment Management
Address: 300 Frank Ogawa Plaza, Ste 510
City: Oakland County: Alameda
State: CA Zip: 94612

Table with 5 columns: Republic Services Approval #, Description of Waste, Volume/Weight, Expiration Date, Container Type. Row 1: 38251011244, Soil for disposal, 39.00, 12-31-2011, Tractor with Dump Trailer(s).

*Attach Additional Sheet if necessary

I hereby certify that the above-described materials are non-hazardous wastes as defined by 40 CFR 261 or any applicable state law. Further, that the above named materials are properly classified, described, packaged, marked and labeled, and are in proper condition for transportation according to the applicable regulations of the Department of Transportation.

Susan Crowley (Signature)
Generator/Authorized Agent Name Signature Date Shipped

TRANSPORTER INFORMATION

Transporter Name: Las Vegas Paving DOT # 191949
Address: 4420 S. Decatur Truck Number:
Las Vegas, NV 89103 Phone Number: (702) 353-4355

I certify no hazardous waste or other regulated substance was knowingly introduced to the waste while in my custody. The waste transported in this vehicle is the waste identified above, to the best of my knowledge.

(Signature)
Name of Authorized Agent Signature Date Delivered 10-7-10

DISPOSAL SITE INFORMATION

Site Name: Apex Regional Landfill Phone No. (702) 599-5920
Address: 13550 U.S. Hwy 93 Las Vegas, NV

I hereby acknowledge receipt of the above described materials
Juan Moreno (Signature)
Name (Print or Type) Signature Date Received 10-7-10

81 Environmental Tech
13550 N Highway 93
Las Vegas, NV 89165

Ticket Type: INBOUND INVOICE

Ticket Number: 1948
Date: 10/07/2010
Time In: 11:13 am
Time Out: 11:40 am

Customer: 001011 - NGE, LLC c/o Northgate Environ Mgmt

Vehicle/Container: 71893P

Contract: Northgate Env. On Site Soils 3825 11

Comment: JN 7 3825-10-11244

Gross Weight: 132,240 LB Manual In
Tare Weight: 53,500 LB Manual Out
Net Weight: 78,740 LB
Net Tons: 39.37

*manifest
12038*

Origin	Yards	Material	Billing Quantity
Not Applicable	0.00 YD	SW CONTAMINATED SOIL	39.37 TN

Driver: _____

Weighmaster: _____

IN - walkera OUT - GUILFDE

Indemnification. Customer agrees, by signature above, to indemnify, hold harmless, and defend Republic Services, Inc., its subsidiaries, affiliates, employees, officers and directors from and against any and all liabilities, claims, penalties, forfeitures, suits and the costs and expenses incident thereto, including costs of defense, settlement, and reasonable attorney's fees, which may be incurred, as a result of death or injuries to any person, or damage to any property, contamination of or adverse effects on the environment, caused in whole or in part by the Customer, its employees, or subcontractors in disposing waste at this Facility. In the event Customer delivers Unacceptable Waste (as determined by Republic) Customer agrees to assume all expenses and obligations with the removal and/or resolution of any effects caused by the delivery of such Unacceptable Waste.

Indemnización. Cliente acuerda indemnizar, mantener inmune, y defender Republic Services, Inc., sus subsidiarios, compañías, divisiones, empleados, oficiales y directores contra de cualquiera y de todas responsabilidades, demandas, penas, pérdidas, juicios, pleitos y los costos incidente además, incluyendo costos de defensa, de acuerdo judicial, y de honorarios razonables del abogado, que pueden ser incurridos en, o como resultado de, la muerte o herida personal a cualquier persona, o daños a cualquier característica, propiedad, contaminación de la tierra o efectos ilícitos en esta Facilidad, causado entero o en parte por el cliente, sus empleados, o sus subcontratistas en botar basura en esta Facilidad. En el caso que el Cliente entrega, bota, basura (según lo determinado por Republic) en este Establecimiento basura inaceptable en los reglamentos de este Establecimiento, el Cliente se compromete asumir todos los costos y obligaciones con el retiro y/o la resolución de cualquier dano(s) causado por la entrega de tal basura inaceptable.



NON-HAZARDOUS WASTE MANIFEST

MANIFEST # 12038

GENERATOR INFORMATION

Generator Name: Tronox LLC
Address: P.O. Box 55
City: Henderson County: Clark
State: NV Zip: 89009
Site Location (if different): 560 W. Lake Mead
Henderson, NV 89015 (702) 592-7727

CUSTOMER/BILLING INFORMATION

Billing Name: NGE LLC c/o Northgate Environment Management
Address: 300 Frank Ogawa Plaza, Ste 510
City: Oakland County: Alameda
State: CA Zip: 94612

Table with 5 columns: Republic Services Approval #, Description of Waste, Volume/Weight, Expiration Date, Container Type. Row 1: 38251011244, Soil for disposal, 39.37, 12-31-2011, Tractor with Dump Trailer(s).

*Attach Additional Sheet if necessary

I hereby certify that the above-described materials are non-hazardous wastes as defined by 40 CFR 261 or any applicable state law. Further, that the above named materials are properly classified, described, packaged, marked and labeled, and are in proper condition for transportation according to the applicable regulations of the Department of Transportation.

Susan Crowley
Generator/Authorized Agent Name Signature Date Shipped

TRANSPORTER INFORMATION

Transporter Name: Las Vegas Paving DOT # 191949
Address: 4420 S. Decatur Truck Number: 7
Las Vegas, NV 89103 Phone Number: (702) 353-4355

I certify no hazardous waste or other regulated substance was knowingly introduced to the waste while in my custody. The waste transported in this vehicle is the waste identified above, to the best of my knowledge.

Name of Authorized Agent Signature Date Delivered 10-7-10

DISPOSAL SITE INFORMATION

Site Name: Apex Regional Landfill Phone No. (702) 599-5920
Address: 13550 U.S. Hwy 93 Las Vegas, NV

I hereby acknowledge receipt of the above described materials.
Dobbie Suitside Signature Date Received 10-7-10

81 Environmental Tech
13550 N Highway 93
Las Vegas, NV 89165

Ticket Type: INBOUND INVOICE

Ticket Number: 1949
Date: 10/07/2010
Time In: 11:49 am
Time Out: 12:13 pm

Customer: 001011 - NGE, LLC c/o Northgate Environ Mgmt

Vehicle/Container: 68628P
Contract: Northgate Env. On Site Soils 3825 11
Comment: RH 301 & 3825 10 11244

Gross Weight: 134,520 LB Manual In
Tare Weight: 54,760 LB Scale Out
Net Weight: 79760 LB
Net Tons: 39.88

BOL: 12039

Origin	Yards	Material	Billing	Quantity
Not Applicable	0.00 YD	SW CONTAMINATED SOIL	39.88	TN

Driver: J S >

Weighmaster: [Signature]

IN - MORENOJ OUT - WALKERA

Indemnification. Customer agrees, by signature above, to indemnify, hold harmless, and defend Republic Services, Inc., its subsidiaries, affiliates, employees, officers and directors from and against any and all liabilities, claims, penalties, forfeitures, suits and the costs and expenses incident thereto, including costs of defense, settlement, and reasonable attorney's fees, which may be incurred, as a result of death or injuries to any person, or damage to any property, contamination of or adverse effects on the environment, caused in whole or in part by the Customer, its employees, or subcontractors in disposing waste at this Facility. In the event Customer delivers Unacceptable Waste (as determined by Republic) Customer agrees to assume all expenses and obligations with the removal and/or resolution of any effects caused by the delivery of such Unacceptable Waste.

Indemnización. Cliente acuerda indemnizar, mantener inmune, y defender Republic Services, Inc., sus subsidiarios, compañías, divisiones, empleados, oficiales y directores contra de cualquiera y de todas responsabilidades, demandas, penas, pérdidas, juicios, pleitos y los costos incidente además, incluyendo costos de defensa, de acuerdo judicial, y de honorarios razonables del abogado, que pueden ser incurridos en, o como resultado de, la muerte o herida personal a cualquier persona, o daños a cualquier característica, propiedad, contaminación de la tierra o efectos ilícitos en esta Facilidad. En el caso que el Cliente entrega, bota, basura (según lo determinado por Republic) en este Establecimiento basura inaceptable en los reglamentos de este Establecimiento, el Cliente se compromete asumir todos los costos y obligaciones con el retiro y/o la resolución de cualquier dano(s) causado por la entrega de tal basura inaceptable.



NON-HAZARDOUS WASTE MANIFEST

MANIFEST # 12039

GENERATOR INFORMATION

Generator Name: Tronox LLC

Address: P.O. Box 55

City: Henderson County: Clark

State: NV Zip: 89009

Site Location (if different): 560 W. Lake Mead

Henderson, NV 89015 (702) 592-7727

CUSTOMER/BILLING INFORMATION

Billing Name: NGE LLC c/o Northgate Environment Management

Address: 300 Frank Ogawa Plaza, Ste 510

City: Oakland County: Alameda

State: CA Zip: 94612

Republic Services Approval #	Description of Waste	Volume/Weight	Expiration Date	Container Type
38251011244	Soil for disposal		12-31-2011	Tractor with Dump Trailer(s)
	RZ- _____ # _____	39.88		

*Attach Additional Sheet if necessary

I hereby certify that the above-described materials are non-hazardous wastes as defined by 40 CFR 261 or any applicable state law. Further, that the above named materials are properly classified, described, packaged, marked and labeled, and are in proper condition for transportation according to the applicable regulations of the Department of Transportation.

Susan Crowley
Generator/Authorized Agent Name Signature Date Shipped

TRANSPORTER INFORMATION

Transporter Name: Las Vegas Paving

DOT # 191949

Address: 4420 S. Decatur

Truck Number: RH301

Las Vegas, NV 89103

Phone Number: (702) 353-4355

I certify no hazardous waste or other regulated substance was knowingly introduced to the waste while in my custody. The waste transported in this vehicle is the waste identified above, to the best of my knowledge.

Name of Authorized Agent Signature Date Delivered

DISPOSAL SITE INFORMATION

Site Name: Apex Regional Landfill

Phone No. (702) 599-5920

Address: 13550 U.S. Hwy 93 Las Vegas, NV

I hereby acknowledge receipt of the above described materials

Name (Print or Type) Signature Date Received

81 Environmental Tech
13550 N Highway 93
Las Vegas, NV 89165

Ticket Type: INBOUND INVOICE

Ticket Number: 1950
Date: 10/07/2010
Time In: 11:52 am
Time Out: 12:16 pm

Customer: 001011 - NGE, LLC c/o Northgate Environ Mgmt

Vehicle/Container: 85887P

Gross Weight: 124,900 LB Manual In
Tare Weight: 52,160 LB Manual Out
Net Weight: 72740 LB
Net Tons: 36.37

Contract: Northgate Env. On Site Soils 3825 11

Comment: R01 & 3825 10 11244

BOL: 12040

Origin	Yards	Material	Billing	Quantity
Not Applicable	0.00 YD	SW CONTAMINATED SOIL	36.37	TN

Driver: Miguel

Weighmaster: ADW

IN - MORENOJ OUT - WALKERA

Indemnification. Customer agrees, by signature above, to indemnify, hold harmless, and defend Republic Services, Inc., its subsidiaries, affiliates, employees, officers and directors from and against any and all liabilities, claims, penalties, forfeitures, suits and the costs and expenses incident thereto, including costs of defense, settlement, and reasonable attorney's fees, which may be incurred, as a result of death or injuries to any person, or damage to any property, contamination of or adverse effects on the environment, caused in whole or in part by the Customer, its employees, or subcontractors in disposing waste at this Facility. In the event Customer delivers Unacceptable Waste (as determined by Republic) Customer agrees to assume all expenses and obligations with the removal and/or resolution of any effects caused by the delivery of such Unacceptable Waste.

Indemnización. Cliente acuerda indemnizar, mantener inmune, y defender Republic Services, Inc., sus subsidiarios, compañías, divisiones, empleados, oficiales y directores contra de cualquiera y de todas responsabilidades, demandas, penas, pérdidas, juicios, pleitos y los costos incidente además, incluyendo costos de defensa, de acuerdo judicial, y de honorarios razonables del abogado, que pueden ser incurridos en, o como resultado de, la muerte o herida personal a cualquier persona, o daños a cualquier característica, propiedad, contaminación de la tierra o efectos ilícitos en esta Facilidad, causado entero o en parte por el cliente, sus empleados, o sus subcontratistas en botar basura en esta Facilidad. En el caso que el Cliente entrega, bota, basura (según lo determinado por Republic) en este Establecimiento basura inaceptable en los reglamentos de este Establecimiento, el Cliente se compromete asumir todos los costos y obligaciones con el retiro y/o la resolución de cualquier dano(s) causado por la entrega de tal basura inaceptable.



NON-HAZARDOUS WASTE MANIFEST

MANIFEST # 12040

GENERATOR INFORMATION

Generator Name: Tronox LLC
Address: P.O. Box 55
City: Henderson County: Clark
State: NV Zip: 89009
Site Location (if different): 560 W. Lake Mead
Henderson, NV 89015 (702) 592-7727

CUSTOMER/BILLING INFORMATION

Billing Name: NGE LLC c/o Northgate Environment Management
Address: 300 Frank Ogawa Plaza, Ste 510
City: Oakland County: Alameda
State: CA Zip: 94612

Table with 5 columns: Republic Services Approval #, Description of Waste, Volume/Weight, Expiration Date, Container Type. Row 1: 38251011244, Soil for disposal, 36.37, 12-31-2011, Tractor with Dump Trailer(s). Row 2: RZ- #, 36.37.

*Attach Additional Sheet if necessary

I hereby certify that the above-described materials are non-hazardous wastes as defined by 40 CFR 261 or any applicable state law. Further, that the above named materials are properly classified, described, packaged, marked and labeled, and are in proper condition for transportation according to the applicable regulations of the Department of Transportation.

Susan Crowley
Generator/Authorized Agent Name Signature Date Shipped

TRANSPORTER INFORMATION

Transporter Name: Las Vegas Paving DOT # 191949
Address: 4420 S. Decatur Truck Number: 201
Las Vegas, NV 89103 Phone Number: (702) 353-4355

I certify no hazardous waste or other regulated substance was knowingly introduced to the waste while in my custody. The waste transported in this vehicle is the waste identified above, to the best of my knowledge.

Name of Authorized Agent Signature Date Delivered 10-7-10

DISPOSAL SITE INFORMATION

Site Name: Apex Regional Landfill Phone No. (702) 599-5920
Address: 13550 U.S. Hwy 93 Las Vegas, NV

I hereby acknowledge receipt of the above described materials
Name (Print or Type) Signature Date Received 10/7/10

81 Environmental Tech
13550 N Highway 93
Las Vegas, NV 89165

Ticket Type: INBOUND INVOICE

Ticket Number: 1951
Date: 10/07/2010
Time In: 12:01 pm
Time Out: 12:28 pm

Customer: 001011 - NGE, LLC c/o Northgate Environ Mgmt

Vehicle/Container: 44564A
Contract: Northgate Env. On Site Soils 3825 11
Comment: K006 & 3825 10 11244

Gross Weight: 127,760 LB Manual In
Tare Weight: 55,900 LB Scale Out
Net Weight: 71860 LB
Net Tons: 35.93

BOL: 12041

Origin	Yards	Material	Billing Quantity
Not Applicable	0.00 YD	SW CONTAMINATED SOIL	35.93 TN

Driver: 

Weighmaster: 

IN - MORENOJ OUT - WALKERA

Indemnification. Customer agrees, by signature above, to indemnify, hold harmless, and defend Republic Services, Inc., its subsidiaries, affiliates, employees, officers and directors from and against any and all liabilities, claims, penalties, forfeitures, suits and the costs and expenses incident thereto, including costs of defense, settlement, and reasonable attorney's fees, which may be incurred, as a result of death or injuries to any person, or damage to any property, contamination of or adverse effects on the environment, caused in whole or in part by the Customer, its employees, or subcontractors in disposing waste at this Facility. In the event Customer delivers Unacceptable Waste (as determined by Republic) Customer agrees to assume all expenses and obligations with the removal and/or resolution of any effects caused by the delivery of such Unacceptable Waste.

Indemnización. Cliente acuerda indemnizar, mantener inmune, y defender Republic Services, Inc., sus subsidiarios, companias, divisiones, empleados, oficiales y directores contra de cualquiera y de todas responsabilidades, demandas, penas, pérdidas, juicios, pleitos y los costos incidente además, incluyendo costos de defensa, de acuerdo judicial, y de honorarios razonables del abogado, que pueden ser incurridos en, o como resultado de, la muerte o herida personal a cualquier persona, o daños a cualquier característica, propiedad, contaminación de la tierra o efectos ilicitos en esta Facilidad, causado entero o en parte por el cliente, sus empleados, o sus subcontratistas en botar basura en esta Facilidad. En el caso que el Cliente entrega, bota, basura (según lo determinado por Republic) en este Establecimiento basura inaceptable en los reglamentos de este Establecimiento, el Cliente se compromete asumir todos los costos y obligaciones con el retiro y/o la resolución de cualquier dano(s) causado por la entrega de tal basura inaceptable.



NON-HAZARDOUS WASTE MANIFEST

MANIFEST # 12041

GENERATOR INFORMATION

Generator Name: Tronox LLC
Address: P.O. Box 55
City: Henderson County: Clark
State: NV Zip: 89009
Site Location (if different): 560 W. Lake Mead
Henderson, NV 89015 (702) 592-7727

CUSTOMER/BILLING INFORMATION

Billing Name: NGE LLC c/o Northgate Environment Management
Address: 300 Frank Ogawa Plaza, Ste 510
City: Oakland County: Alameda
State: CA Zip: 94612

Table with 5 columns: Republic Services Approval #, Description of Waste, Volume/Weight, Expiration Date, Container Type. Row 1: 38251011244, Soil for disposal, 35.93, 12-31-2011, Tractor with Dump Trailer(s).

*Attach Additional Sheet if necessary

I hereby certify that the above-described materials are non-hazardous wastes as defined by 40 CFR 261 or any applicable state law. Further, that the above named materials are properly classified, described, packaged, marked and labeled, and are in proper condition for transportation according to the applicable regulations of the Department of Transportation.

Susan Crowley (Signature)
Generator/Authorized Agent Name Signature Date Shipped

TRANSPORTER INFORMATION

Transporter Name: Las Vegas Paving DOT # 191949
Address: 4420 S. Decatur Truck Number: K-006
Las Vegas, NV 89103 Phone Number: (702) 353-4355

I certify no hazardous waste or other regulated substance was knowingly introduced to the waste while in my custody. The waste transported in this vehicle is the waste identified above, to the best of my knowledge.

Brian Mulvey (Signature)
Name of Authorized Agent Signature Date Delivered 10.7.10

DISPOSAL SITE INFORMATION

Site Name: Apex Regional Landfill Phone No. (702) 599-5920
Address: 13550 U.S. Hwy 93 Las Vegas, NV

I hereby acknowledge receipt of the above described materials
Ariel Drake-Walker (Signature)
Name (Print or Type) Signature Date Received 10/7/10

81 Environmental Tech
13550 N Highway 93
Las Vegas, NV 89165

Ticket Type: INBOUND INVOICE

Ticket Number: 1952
Date: 10/07/2010
Time In: 12:06 pm
Time Out: 12:33 pm

Customer: 001011 - NGE, LLC c/o Northgate Environ Mgmt

Vehicle/Container: Z009877
Contract: Northgate Env. On Site Soils 3825 11
Comment: 2010 3825-10-11244

Gross Weight: 126,400 LB Manual In
Tare Weight: 48,280 LB Scale Out
Net Weight: 78120 LB
Net Tons: 39.06

BOL: 12043

Origin	Yards	Material	Billing	Quantity
Not Applicable	0.00 YD	SW CONTAMINATED SOIL	39.06	TN

Driver: _____

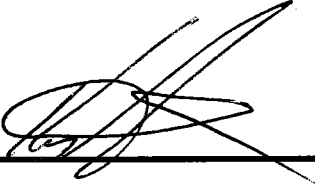

Weighmaster: _____



IN - GUILFDE OUT - WALKERA

Indemnification. Customer agrees, by signature above, to indemnify, hold harmless, and defend Republic Services, Inc., its subsidiaries, affiliates, employees, officers and directors from and against any and all liabilities, claims, penalties, forfeitures, suits and the costs and expenses incident thereto, including costs of defense, settlement, and reasonable attorney's fees, which may be incurred, as a result of death or injuries to any person, or damage to any property, contamination of or adverse effects on the environment, caused in whole or in part by the Customer, its employees, or subcontractors in disposing waste at this Facility. In the event Customer delivers Unacceptable Waste (as determined by Republic) Customer agrees to assume all expenses and obligations with the removal and/or resolution of any effects caused by the delivery of such Unacceptable Waste.

Indemnización. Cliente acuerda indemnizar, mantener inmune, y defender Republic Services, Inc., sus subsidiarios, compañías, divisiones, empleados, oficiales y directores contra de cualquiera y de todas responsabilidades, demandas, penas, pérdidas, juicios, pleitos y los costos incidente además, incluyendo costos de defensa, de acuerdo judicial, y de honorarios razonables del abogado, que pueden ser incurridos en, o como resultado de, la muerte o herida personal a cualquier persona, o daños a cualquier característica, propiedad, contaminación de la tierra o efectos ilícitos en esta Facilidad, causado entero o en parte por el cliente, sus empleados, o sus subcontratistas en botar basura en esta Facilidad. En el caso que el Cliente entrega, bota, basura (según lo determinado por Republic) en este Establecimiento basura inaceptable en los reglamentos de este Establecimiento, el Cliente se compromete asumir todos los costos y obligaciones con el retiro y/o la resolución de cualquier dano(s) causado por la entrega de tal basura inaceptable.



NON-HAZARDOUS WASTE MANIFEST

MANIFEST # 12043

GENERATOR INFORMATION

Generator Name: Tronox LLC
Address: P.O. Box 55
City: Henderson County: Clark
State: NV Zip: 89009
Site Location (if different): 560 W. Lake Mead
Henderson, NV 89015 (702) 592-7727

CUSTOMER/BILLING INFORMATION

Billing Name: NGE LLC c/o Northgate Environment Management
Address: 300 Frank Ogawa Plaza, Ste 510
City: Oakland County: Alameda
State: CA Zip: 94612

Table with 5 columns: Republic Services Approval #, Description of Waste, Volume/Weight, Expiration Date, Container Type. Row 1: 38251011244, Soil for disposal, 39.06, 12-31-2011, Tractor with Dump Trailer(s). Row 2: RZ- #, 39.06.

*Attach Additional Sheet if necessary

I hereby certify that the above-described materials are non-hazardous wastes as defined by 40 CFR 261 or any applicable state law. Further, that the above named materials are properly classified, described, packaged, marked and labeled, and are in proper condition for transportation according to the applicable regulations of the Department of Transportation.

Susan Crowley (Signature)
Generator/Authorized Agent Name Signature Date Shipped

TRANSPORTER INFORMATION

Transporter Name: Las Vegas Paving DOT # 191949
Address: 4420 S. Decatur Truck Number:
Las Vegas, NV 89103 Phone Number: (702) 353-4355

I certify no hazardous waste or other regulated substance was knowingly introduced to the waste while in my custody. The waste transported in this vehicle is the waste identified above, to the best of my knowledge.

(Signature)
Name of Authorized Agent Signature Date Delivered 10-7-10

DISPOSAL SITE INFORMATION

Site Name: Apex Regional Landfill Phone No. (702) 599-5920
Address: 13550 U.S. Hwy 93 Las Vegas, NV

I hereby acknowledge receipt of the above described materials

(Signature)
Name (Print or Type) Signature Date Received 10/7/10

81 Environmental Tech
13550 N Highway 93
Las Vegas, NV 89165

Ticket Type: INBOUND INVOICE

Ticket Number: 1953
Date: 10/07/2010
Time In: 12:07 pm
Time Out: 12:37 pm

Customer: 001011 - NGE, LLC c/o Northgate Environ Mgmt

Vehicle/Container: 85914P
Contract: Northgate Env. On Site Soils 3825 11
Comment: DEL 07 & 3825 10 11244

Gross Weight: 123,240 LB Manual In
Tare Weight: 54,020 LB Scale Out
Net Weight: 69220 LB
Net Tons: 34.61

BOL: 12042

Origin	Yards	Material	Billing	Quantity
Not Applicable	0.00 YD	SW CONTAMINATED SOIL	34.61	TN

Driver: _____

Weighmaster: _____

IN - MORENOJ OUT - WALKERA

Indemnification. Customer agrees, by signature above, to indemnify, hold harmless, and defend Republic Services, Inc., its subsidiaries, affiliates, employees, officers and directors from and against any and all liabilities, claims, penalties, forfeitures, suits and the costs and expenses incident thereto, including costs of defense, settlement, and reasonable attorney's fees, which may be incurred, as a result of death or injuries to any person, or damage to any property, contamination of or adverse effects on the environment, caused in whole or in part by the Customer, its employees, or subcontractors in disposing waste at this Facility. In the event Customer delivers Unacceptable Waste (as determined by Republic) Customer agrees to assume all expenses and obligations with the removal and/or resolution of any effects caused by the delivery of such Unacceptable Waste.

Indemnización. Cliente acuerda indemnizar, mantener inmune, y defender Republic Services, Inc., sus subsidiarios, compañías, divisiones, empleados, oficiales y directores contra de cualquiera y de todas responsabilidades, demandas, penas, pérdidas, juicios, pleitos y los costos incidente además, incluyendo costos de defensa, de acuerdo judicial, y de honorarios razonables del abogado, que pueden ser incurridos en, o como resultado de, la muerte o herida personal a cualquier persona, o daños a cualquier característica, propiedad, contaminación de la tierra o efectos ilícitos en esta Facilidad, causado entero o en parte por el cliente, sus empleados, o sus subcontratistas en botar basura en esta Facilidad. En el caso que el Cliente entrega, bota, basura (según lo determinado por Republic) en este Establecimiento basura inaceptable en los reglamentos de este Establecimiento, el Cliente se compromete asumir todos los costos y obligaciones con el retiro y/o la resolución de cualquier dano(s) causado por la entrega de tal basura inaceptable.



NON-HAZARDOUS WASTE MANIFEST

MANIFEST # 12042

GENERATOR INFORMATION

Generator Name: Tronox LLCAddress: P.O. Box 55City: Henderson County: ClarkState: NV Zip: 89009Site Location (if different): 560 W. Lake Mead
Henderson, NV 89015 (702) 592-7727

CUSTOMER/BILLING INFORMATION

Billing Name: NGE LLC c/o Northgate Environment ManagementAddress: 300 Frank Ogawa Plaza, Ste 510City: Oakland County: AlamedaState: CA Zip: 94612

Republic Services Approval #	Description of Waste	Volume/Weight	Expiration Date	Container Type
38251011244	Soil for disposal		12-31-2011	Tractor with Dump Trailer(s)
	RZ- _____ # _____	34.61		

*Attach Additional Sheet if necessary

I hereby certify that the above-described materials are non-hazardous wastes as defined by 40 CFR 261 or any applicable state law. Further, that the above named materials are properly classified, described, packaged, marked and labeled, and are in proper condition for transportation according to the applicable regulations of the Department of Transportation.

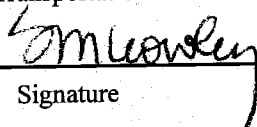
Susan Crowley 
 Generator/Authorized Agent Name Signature Date Shipped

TRANSPORTER INFORMATION

Transporter Name: Las Vegas PavingDOT # 191949Address: 4420 S. DecaturTruck Number: DEL 07Las Vegas, NV 89103Phone Number: (702) 353-4355

I certify no hazardous waste or other regulated substance was knowingly introduced to the waste while in my custody. The waste transported in this vehicle is the waste identified above, to the best of my knowledge.

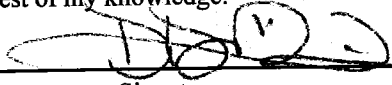
DAVID DELCID 
 Name of Authorized Agent Signature Date Delivered 10-7-10

DISPOSAL SITE INFORMATION

Site Name: Apex Regional LandfillPhone No. (702) 599-5920Address: 13550 U.S. Hwy 93 Las Vegas, NV

I hereby acknowledge receipt of the above described materials

Orin Drake Walker 
 Name (Print or Type) Signature Date Received 10/7/10

81 Environmental Tech
13550 N Highway 93
Las Vegas, NV 89165

Ticket Type: INBOUND INVOICE

Ticket Number: 1954
Date: 10/07/2010
Time In: 12:18 pm
Time Out: 12:44 pm

Customer: 001011 - NGE, LLC c/o Northgate Environ Mgmt

Vehicle/Container: 82515P
Contract: Northgate Env. On Site Soils 3825 11
Comment: 144 3825-10-11244

Gross Weight: 120,300 LB Manual In
Tare Weight: 52,760 LB Scale Out
Net Weight: 67540 LB
Net Tons: 33.77

BOL: 12044

Origin	Yards	Material	Billing Quantity
Not Applicable	0.00 YD	SW CONTAMINATED SOIL	33.77 TN

Driver:

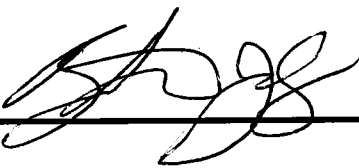

Weighmaster:



IN - WALKERA OUT - MORENOJ

Indemnification. Customer agrees, by signature above, to indemnify, hold harmless, and defend Republic Services, Inc., its subsidiaries, affiliates, employees, officers and directors from and against any and all liabilities, claims, penalties, forfeitures, suits and the costs and expenses incident thereto, including costs of defense, settlement, and reasonable attorney's fees, which may be incurred, as a result of death or injuries to any person, or damage to any property, contamination of or adverse effects on the environment, caused in whole or in part by the Customer, its employees, or subcontractors in disposing waste at this Facility. In the event Customer delivers Unacceptable Waste (as determined by Republic) Customer agrees to assume all expenses and obligations with the removal and/or resolution of any effects caused by the delivery of such Unacceptable Waste.

Indemnización. Cliente acuerda indemnizar, mantener inmune, y defender Republic Services, Inc., sus subsidiarios, compañías, divisiones, empleados, oficiales y directores contra de cualquiera y de todas responsabilidades, demandas, penas, pérdidas, juicios, pleitos y los costos incidente además, incluyendo costos de defensa, de acuerdo judicial, y de honorarios razonables del abogado, que pueden ser incurridos en, o como resultado de, la muerte o herida personal a cualquier persona, o daños a cualquier característica, propiedad, contaminación de la tierra o efectos ilícitos en esta Facilidad, causado entero o en parte por el cliente, sus empleados, o sus subcontratistas en botar basura en esta Facilidad. En el caso que el Cliente entrega, bota, basura (según lo determinado por Republic) en este Establecimiento basura inaceptable en los reglamentos de este Establecimiento, el Cliente se compromete asumir todos los costos y obligaciones con el retiro y/o la resolución de cualquier dano(s) causado por la entrega de tal basura inaceptable.



NON-HAZARDOUS WASTE MANIFEST

MANIFEST # 12044

GENERATOR INFORMATION

Generator Name: Tronox LLC

Address: P.O. Box 55

City: Henderson County: Clark

State: NV Zip: 89009

Site Location (if different): 560 W. Lake Mead

Henderson, NV 89015 (702) 592-7727

CUSTOMER/BILLING INFORMATION

Billing Name: NGE LLC c/o Northgate Environment Management

Address: 300 Frank Ogawa Plaza, Ste 510

City: Oakland County: Alameda

State: CA Zip: 94612

Table with 5 columns: Republic Services Approval #, Description of Waste, Volume/Weight, Expiration Date, Container Type. Row 1: 38251011244, Soil for disposal, 3377, 12-31-2011, Tractor with Dump Trailer(s). Row 2: RZ- #

*Attach Additional Sheet if necessary

I hereby certify that the above-described materials are non-hazardous wastes as defined by 40 CFR 261 or any applicable state law. Further, that the above named materials are properly classified, described, packaged, marked and labeled, and are in proper condition for transportation according to the applicable regulations of the Department of Transportation.

Susan Crowley (Name), [Signature] (Signature), Date Shipped

TRANSPORTER INFORMATION

Transporter Name: Las Vegas Paving

DOT # 191949

Address: 4420 S. Decatur

Truck Number: SR 144

Las Vegas, NV 89103

Phone Number: (702) 353-4355

I certify no hazardous waste or other regulated substance was knowingly introduced to the waste while in my custody. The waste transported in this vehicle is the waste identified above, to the best of my knowledge.

[Signature] (Name of Authorized Agent), [Signature] (Signature), 10-7-10 (Date Delivered)

DISPOSAL SITE INFORMATION

Site Name: Apex Regional Landfill

Phone No. (702) 599-5920

Address: 13550 U.S. Hwy 93 Las Vegas, NV

I hereby acknowledge receipt of the above described materials

[Signature] (Name (Print or Type)), [Signature] (Signature), [Signature] (Date Received)

81 Environmental Tech
13550 N Highway 93
Las Vegas, NV 89165

Ticket Type: INBOUND INVOICE

Ticket Number: 1956
Date: 10/07/2010
Time In: 12:44 pm
Time Out: 1:12 pm

Customer: 001011 - NGE, LLC c/o Northgate Environ Mgmt

Vehicle/Container: 84893P
Contract: Northgate Env. On Site Soils 3825 11
Comment: 303 3825-10-11244

Gross Weight: 128,760 LB Manual In
Tare Weight: 53,700 LB Scale Out
Net Weight: 75060 LB
Net Tons: 37.53

BOL: 12046

Origin	Yards	Material	Billing Quantity
Not Applicable	0.00 YD	SW CONTAMINATED SOIL	37.53 TN

Driver: _____



Weighmaster: _____

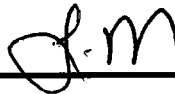

IN - WALKERA OUT - MORENOJ

Indemnification. Customer agrees, by signature above, to indemnify, hold harmless, and defend Republic Services, Inc., its subsidiaries, affiliates, employees, officers and directors from and against any and all liabilities, claims, penalties, forfeitures, suits and the costs and expenses incident thereto, including costs of defense, settlement, and reasonable attorney's fees, which may be incurred, as a result of death or injuries to any person, or damage to any property, contamination of or adverse effects on the environment, caused in whole or in part by the Customer, its employees, or subcontractors in disposing waste at this Facility. In the event Customer delivers Unacceptable Waste (as determined by Republic) Customer agrees to assume all expenses and obligations with the removal and/or resolution of any effects caused by the delivery of such Unacceptable Waste.

Indemnización. Cliente acuerda indemnizar, mantener inmune, y defender Republic Services, Inc., sus subsidiarios, companias, divisiones, empleados, oficiales y directores contra de cualquiera y de todas responsabilidades, demandas, penas, pérdidas, juicios, pleitos y los costos incidente además, incluyendo costos de defensa, de acuerdo judicial, y de honorarios razonables del abogado, que pueden ser incurridos en, o como resultado de, la muerte o herida personal a cualquier persona, o daños a cualquier característica, propiedad, contaminación de la tierra o efectos ilicitos en esta Facilidad, causado entero o en parte por el cliente, sus empleados, o sus subcontratistas en botar basura en esta Facilidad. En el caso que el Cliente entrega, bota, basura (según lo determinado por Republic) en este Establecimiento basura inaceptable en los reglamentos de este Establecimiento, el Cliente se compromete asumir todos los costos y obligaciones con el retiro y/o la resolución de cualquier dano(s) causado por la entrega de tal basura inaceptable.



NON-HAZARDOUS WASTE MANIFEST

MANIFEST # 12046

GENERATOR INFORMATION

Generator Name: Tronox LLC

Address: P.O. Box 55

City: Henderson County: Clark

State: NV Zip: 89009

Site Location (if different): 560 W. Lake Mead

Henderson, NV 89015 (702) 592-7727

CUSTOMER/BILLING INFORMATION

Billing Name: NGE LLC c/o Northgate Environment Management

Address: 300 Frank Ogawa Plaza, Ste 510

City: Oakland County: Alameda

State: CA Zip: 94612

Republic Services Approval #	Description of Waste	Volume/Weight	Expiration Date	Container Type
38251011244	Soil for disposal		12-31-2011	Tractor with Dump Trailer(s)
	RZ- #	37.53		

*Attach Additional Sheet if necessary

I hereby certify that the above-described materials are non-hazardous wastes as defined by 40 CFR 261 or any applicable state law. Further, that the above named materials are properly classified, described, packaged, marked and labeled, and are in proper condition for transportation according to the applicable regulations of the Department of Transportation.

Susan Crowley (Signature) Generator/Authorized Agent Name Date Shipped

TRANSPORTER INFORMATION

Transporter Name: Las Vegas Paving

DOT # 191949

Address: 4420 S. Decatur

Truck Number: 303

Las Vegas, NV 89103

Phone Number: (702) 353-4355

I certify no hazardous waste or other regulated substance was knowingly introduced to the waste while in my custody. The waste transported in this vehicle is the waste identified above, to the best of my knowledge.

(Signature) Name of Authorized Agent Signature Date Delivered 10-7-10

DISPOSAL SITE INFORMATION

Site Name: Apex Regional Landfill

Phone No. (702) 599-5920

Address: 13550 U.S. Hwy 93 Las Vegas, NV

Ivan Moreno (Signature) Name (Print or Type) Date Received 10-7-10

81 Environmental Tech
13550 N Highway 93
Las Vegas, NV 89165

Ticket Type: INBOUND INVOICE

Ticket Number: 1957
Date: 10/07/2010
Time In: 12:45 pm
Time Out: 1:15 pm

Customer: 001011 - NGE, LLC c/o Northgate Environ Mgmt

Vehicle/Container: 44161A
Contract: Northgate Env. On Site Soils 3825 11
Comment: K005 3825-10-11244

Gross Weight: 127,920 LB Scale In
Tare Weight: 52,200 LB Scale Out
Net Weight: 75720 LB
Net Tons: 37.86

BOL: 12045

Origin	Yards	Material	Billing Quantity
Not Applicable	0.00 YD	SW CONTAMINATED SOIL	37.86 TN

Driver:



Weighmaster:

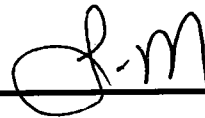

IN - WALKERA OUT - MORENOJ

Indemnification. Customer agrees, by signature above, to indemnify, hold harmless, and defend Republic Services, Inc., its subsidiaries, affiliates, employees, officers and directors from and against any and all liabilities, claims, penalties, forfeitures, suits and the costs and expenses incident thereto, including costs of defense, settlement, and reasonable attorney's fees, which may be incurred, as a result of death or injuries to any person, or damage to any property, contamination of or adverse effects on the environment, caused in whole or in part by the Customer, its employees, or subcontractors in disposing waste at this Facility. In the event Customer delivers Unacceptable Waste (as determined by Republic) Customer agrees to assume all expenses and obligations with the removal and/or resolution of any effects caused by the delivery of such Unacceptable Waste.

Indemnización. Cliente acuerda indemnizar, mantener inmune, y defender Republic Services, Inc., sus subsidiarios, compañías, divisiones, empleados, oficiales y directores contra de cualquiera y de todas responsabilidades, demandas, penas, pérdidas, juicios, pleitos y los costos incidente además, incluyendo costos de defensa, de acuerdo judicial, y de honorarios razonables del abogado, que pueden ser incurridos en, o como resultado de, la muerte o herida personal a cualquier persona, o daños a cualquier característica, propiedad, contaminación de la tierra o efectos ilícitos en esta Facilidad, causado entero o en parte por el cliente, sus empleados, o sus subcontratistas en botar basura en esta Facilidad. En el caso que el Cliente entrega, bota, basura (según lo determinado por Republic) en este Establecimiento basura inaceptable en los reglamentos de este Establecimiento, el Cliente se compromete asumir todos los costos y obligaciones con el retiro y/o la resolución de cualquier dano(s) causado por la entrega de tal basura inaceptable.



NON-HAZARDOUS WASTE MANIFEST

MANIFEST # 12045

GENERATOR INFORMATION

Generator Name: Tronox LLC
Address: P.O. Box 55
City: Henderson County: Clark
State: NV Zip: 89009
Site Location (if different): 560 W. Lake Mead
Henderson, NV 89015 (702) 592-7727

CUSTOMER/BILLING INFORMATION

Billing Name: NGE LLC c/o Northgate Environment Management
Address: 300 Frank Ogawa Plaza, Ste 510
City: Oakland County: Alameda
State: CA Zip: 94612

Table with 5 columns: Republic Services Approval #, Description of Waste, Volume/Weight, Expiration Date, Container Type. Row 1: 38251011244, Soil for disposal, 37.86 TN, 12-31-2011, Tractor with Dump Trailer(s).

*Attach Additional Sheet if necessary

I hereby certify that the above-described materials are non-hazardous wastes as defined by 40 CFR 261 or any applicable state law. Further, that the above named materials are properly classified, described, packaged, marked and labeled, and are in proper condition for transportation according to the applicable regulations of the Department of Transportation.

Susan Crowley (Signature)
Generator/Authorized Agent Name Signature Date Shipped

TRANSPORTER INFORMATION

Transporter Name: Las Vegas Paving DOT # 191949
Address: 4420 S. Decatur Truck Number: K005
Las Vegas, NV 89103 Phone Number: (702) 353-4355

I certify no hazardous waste or other regulated substance was knowingly introduced to the waste while in my custody. The waste transported in this vehicle is the waste identified above, to the best of my knowledge.

(Signature)
Name of Authorized Agent Signature Date Delivered 10-7-10

DISPOSAL SITE INFORMATION

Site Name: Apex Regional Landfill Phone No. (702) 599-5920
Address: 13550 U.S. Hwy 93 Las Vegas, NV

I hereby acknowledge receipt of the above described materials
Juan Moreno (Signature)
Name (Print or Type) Signature Date Received 10-7-10

81 Environmental Tech
13550 N Highway 93
Las Vegas, NV 89165

Ticket Type: INBOUND INVOICE

Ticket Number: 1958
Date: 10/07/2010
Time In: 12:47 pm
Time Out: 1:16 pm

Customer: 001011 - NGE, LLC c/o Northgate Environ Mgmt

Vehicle/Container: 29573A
Contract: Northgate Env. On Site Soils 3825 11
Comment: 17 3825-10-11244

Gross Weight: 133,420 LB Manual In
Tare Weight: 55,460 LB Manual Out
Net Weight: 77,960 LB
Net Tons: 38.98

BOL: 12047

Origin	Yards	Material	Billing Quantity
Not Applicable	0.00 YD	SW CONTAMINATED SOIL	38.98 TN

Driver: _____



Weighmaster: _____



IN - WALKERA OUT - MORENOJ

Indemnification. Customer agrees, by signature above, to indemnify, hold harmless, and defend Republic Services, Inc., its subsidiaries, affiliates, employees, officers and directors from and against any and all liabilities, claims, penalties, forfeitures, suits and the costs and expenses incident thereto, including costs of defense, settlement, and reasonable attorney's fees, which may be incurred, as a result of death or injuries to any person, or damage to any property, contamination of or adverse effects on the environment, caused in whole or in part by the Customer, its employees, or subcontractors in disposing waste at this Facility. In the event Customer delivers Unacceptable Waste (as determined by Republic) Customer agrees to assume all expenses and obligations with the removal and/or resolution of any effects caused by the delivery of such Unacceptable Waste.

Indemnización. Cliente acuerda indemnizar, mantener inmune, y defender Republic Services, Inc., sus subsidiarios, compañías, divisiones, empleados, oficiales y directores contra de cualquiera y de todas responsabilidades, demandas, penas, pérdidas, juicios, pleitos y los costos incidente además, incluyendo costos de defensa, de acuerdo judicial, y de honorarios razonables del abogado, que pueden ser incurridos en, o como resultado de, la muerte o herida personal a cualquier persona, o daños a cualquier característica, propiedad, contaminación de la tierra o efectos ilícitos en esta Facilidad, causado entero o en parte por el cliente, sus empleados, o sus subcontratistas en botar basura en esta Facilidad. En el caso que el Cliente entrega, bota, basura (según lo determinado por Republic) en este Establecimiento basura inaceptable en los reglamentos de este Establecimiento, el Cliente se compromete asumir todos los costos y obligaciones con el retiro y/o la resolución de cualquier dano(s) causado por la entrega de tal basura inaceptable.



NON-HAZARDOUS WASTE MANIFEST

MANIFEST # 12047

GENERATOR INFORMATION

Generator Name: Tronox LLC

Address: P.O. Box 55

City: Henderson County: Clark

State: NV Zip: 89009

Site Location (if different): 560 W. Lake Mead

Henderson, NV 89015 (702) 592-7727

CUSTOMER/BILLING INFORMATION

Billing Name: NGE LLC c/o Northgate Environment Management

Address: 300 Frank Ogawa Plaza, Ste 510

City: Oakland County: Alameda

State: CA Zip: 94612

Republic Services Approval #	Description of Waste	Volume/Weight	Expiration Date	Container Type
38251011244	Soil for disposal	38.98	12-31-2011	Tractor with Dump Trailer(s)
	RZ- #			

*Attach Additional Sheet if necessary

I hereby certify that the above-described materials are non-hazardous wastes as defined by 40 CFR 261 or any applicable state law. Further, that the above named materials are properly classified, described, packaged, marked and labeled, and are in proper condition for transportation according to the applicable regulations of the Department of Transportation.

Susan Crowley Generator/Authorized Agent Name Signature Date Shipped

TRANSPORTER INFORMATION

Transporter Name: Las Vegas Paving

DOT # 191949

Address: 4420 S. Decatur

Truck Number: 17

Las Vegas, NV 89103

Phone Number: (702) 353-4355

I certify no hazardous waste or other regulated substance was knowingly introduced to the waste while in my custody. The waste transported in this vehicle is the waste identified above, to the best of my knowledge.

Name of Authorized Agent Signature Date Delivered 10-7-10

DISPOSAL SITE INFORMATION

Site Name: Apex Regional Landfill

Phone No. (702) 599-5920

Address: 13550 U.S. Hwy 93 Las Vegas, NV

I hereby acknowledge receipt of the above described materials Ivan Moreno Signature Date Received 10-7-10

81 Environmental Tech
13550 N Highway 93
Las Vegas, NV 89165

Ticket Type: INBOUND INVOICE

Ticket Number: 1959
Date: 10/07/2010
Time In: 12:52 pm
Time Out: 1:18 pm

Customer: 001011 - NGE, LLC c/o Northgate Environ Mgmt

Vehicle/Container: 73072P
Contract: Northgate Env. On Site Soils 3825 11
Comment: 135 3825-10-11244

Gross Weight: 126,660 LB Scale In
Tare Weight: 50,860 LB Scale Out
Net Weight: 75800 LB
Net Tons: 37.90

BOL: 12048

Origin	Yards	Material	Billing Quantity
Not Applicable	0.00 YD	SW CONTAMINATED SOIL	37.90 TN

Driver:

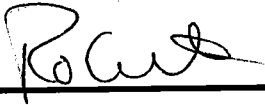

Weighmaster:

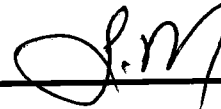

IN - WALKERA OUT - MORENOJ

Indemnification. Customer agrees, by signature above, to indemnify, hold harmless, and defend Republic Services, Inc., its subsidiaries, affiliates, employees, officers and directors from and against any and all liabilities, claims, penalties, forfeitures, suits and the costs and expenses incident thereto, including costs of defense, settlement, and reasonable attorney's fees, which may be incurred, as a result of death or injuries to any person, or damage to any property, contamination of or adverse effects on the environment, caused in whole or in part by the Customer, its employees, or subcontractors in disposing waste at this Facility. In the event Customer delivers Unacceptable Waste (as determined by Republic) Customer agrees to assume all expenses and obligations with the removal and/or resolution of any effects caused by the delivery of such Unacceptable Waste.

Indemnización. Cliente acuerda indemnizar, mantener inmune, y defender Republic Services, Inc., sus subsidiarios, compañías, divisiones, empleados, oficiales y directores contra de cualquiera y de todas responsabilidades, demandas, penas, pérdidas, juicios, pleitos y los costos incidente además, incluyendo costos de defensa, de acuerdo judicial, y de honorarios razonables del abogado, que pueden ser incurridos en, o como resultado de, la muerte o herida personal a cualquier persona, o daños a cualquier característica, propiedad, contaminación de la tierra o efectos ilícitos en esta Facilidad, causado entero o en parte por el cliente, sus empleados, o sus subcontratistas en botar basura en esta Facilidad. En el caso que el Cliente entrega, bota, basura (según lo determinado por Republic) en este Establecimiento basura inaceptable en los reglamentos de este Establecimiento, el Cliente se compromete asumir todos los costos y obligaciones con el retiro y/o la resolución de cualquier dano(s) causado por la entrega de tal basura inaceptable.



NON-HAZARDOUS WASTE MANIFEST

MANIFEST # 12048

GENERATOR INFORMATION

Generator Name: Tronox LLC
Address: P.O. Box 55
City: Henderson County: Clark
State: NV Zip: 89009
Site Location (if different): 560 W. Lake Mead
Henderson, NV 89015 (702) 592-7727

CUSTOMER/BILLING INFORMATION

Billing Name: NGE LLC c/o Northgate Environment Management
Address: 300 Frank Ogawa Plaza, Ste 510
City: Oakland County: Alameda
State: CA Zip: 94612

Table with 5 columns: Republic Services Approval #, Description of Waste, Volume/Weight, Expiration Date, Container Type. Row 1: 38251011244, Soil for disposal, 3790, 12-31-2011, Tractor with Dump Trailer(s). Row 2: RZ- #

*Attach Additional Sheet if necessary

I hereby certify that the above-described materials are non-hazardous wastes as defined by 40 CFR 261 or any applicable state law. Further, that the above named materials are properly classified, described, packaged, marked and labeled, and are in proper condition for transportation according to the applicable regulations of the Department of Transportation.

Susan Crowley (Signature) 10-7-10 (Date Shipped)
Generator/Authorized Agent Name Signature Date Shipped

TRANSPORTER INFORMATION

Transporter Name: Las Vegas Paving DOT # 191949
Address: 4420 S. Decatur Truck Number: 135
Las Vegas, NV 89103 Phone Number: (702) 353-4355

I certify no hazardous waste or other regulated substance was knowingly introduced to the waste while in my custody. The waste transported in this vehicle is the waste identified above, to the best of my knowledge.

(Signature) (Signature) 10-7-10 (Date Delivered)
Name of Authorized Agent Signature Date Delivered

DISPOSAL SITE INFORMATION

Site Name: Apex Regional Landfill Phone No. (702) 599-5920
Address: 13550 U.S. Hwy 93 Las Vegas, NV

I hereby acknowledge receipt of the above described materials
Juan Moreno (Signature) 10-7-10 (Date Received)
Name (Print or Type) Signature Date Received

81 Environmental Tech
13550 N Highway 93
Las Vegas, NV 89165

Ticket Type: INBOUND INVOICE

Ticket Number: 1960
Date: 10/07/2010
Time In: 12:58 pm
Time Out: 1:22 pm

Customer: 001011 - NGE, LLC c/o Northgate Environ Mgmt

Vehicle/Container: 81494P

Contract: Northgate Env. On Site Soils 3825 11
Comment: 125 3825-10-11244

Gross Weight: 104,140 LB Manual In
Tare Weight: 50,660 LB Manual Out
Net Weight: 53480 LB
Net Tons: 26.74

BOL: 12050

Origin	Yards	Material	Billing Quantity
Not Applicable	0.00 YD	SW CONTAMINATED SOIL	26.74 TN

Driver: _____

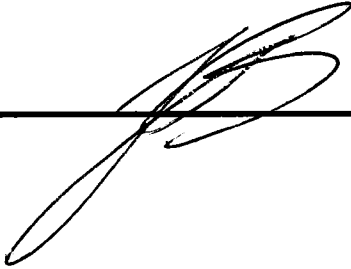

Weighmaster: _____



IN - WALKERA OUT - MORENOJ

Indemnification. Customer agrees, by signature above, to indemnify, hold harmless, and defend Republic Services, Inc., its subsidiaries, affiliates, employees, officers and directors from and against any and all liabilities, claims, penalties, forfeitures, suits and the costs and expenses incident thereto, including costs of defense, settlement, and reasonable attorney's fees, which may be incurred, as a result of death or injuries to any person, or damage to any property, contamination of or adverse effects on the environment, caused in whole or in part by the Customer, its employees, or subcontractors in disposing waste at this Facility. In the event Customer delivers Unacceptable Waste (as determined by Republic) Customer agrees to assume all expenses and obligations with the removal and/or resolution of any effects caused by the delivery of such Unacceptable Waste.

Indemnización. Cliente acuerda indemnizar, mantener inmune, y defender Republic Services, Inc., sus subsidiarios, compañías, divisiones, empleados, oficiales y directores contra de cualquiera y de todas responsabilidades, demandas, penas, pérdidas, juicios, pleitos y los costos incidente además, incluyendo costos de defensa, de acuerdo judicial, y de honorarios razonables del abogado, que pueden ser incurridos en, o como resultado de, la muerte o herida personal a cualquier persona, o daños a cualquier característica, propiedad, contaminación de la tierra o efectos ilícitos en esta Facilidad, causado entero o en parte por el cliente, sus empleados, o sus subcontratistas en botar basura en esta Facilidad. En el caso que el Cliente entrega, bota, basura (según lo determinado por Republic) en este Establecimiento basura inaceptable en los reglamentos de este Establecimiento, el Cliente se compromete asumir todos los costos y obligaciones con el retiro y/o la resolución de cualquier dano(s) causado por la entrega de tal basura inaceptable.



NON-HAZARDOUS WASTE MANIFEST

MANIFEST # 12050

GENERATOR INFORMATION

Generator Name: Tronox LLC

Address: P.O. Box 55

City: Henderson County: Clark

State: NV Zip: 89009

Site Location (if different): 560 W. Lake Mead

Henderson, NV 89015 (702) 592-7727

CUSTOMER/BILLING INFORMATION

Billing Name: NGE LLC c/o Northgate Environment Management

Address: 300 Frank Ogawa Plaza, Ste 510

City: Oakland County: Alameda

State: CA Zip: 94612

Republic Services Approval #	Description of Waste	Volume/Weight	Expiration Date	Container Type
38251011244	Soil for disposal		12-31-2011	Tractor with Dump Trailer(s)
	RZ- _____ # _____	<u>26.74</u>		

*Attach Additional Sheet if necessary

I hereby certify that the above-described materials are non-hazardous wastes as defined by 40 CFR 261 or any applicable state law. Further, that the above named materials are properly classified, described, packaged, marked and labeled, and are in proper condition for transportation according to the applicable regulations of the Department of Transportation.

Susan Crowley [Signature] _____
 Generator/Authorized Agent Name Signature Date Shipped

TRANSPORTER INFORMATION

Transporter Name: Las Vegas Paving

DOT # 191949

Address: 4420 S. Decatur

Truck Number: 125

Las Vegas, NV 89103

Phone Number: (702) 353-4355

I certify no hazardous waste or other regulated substance was knowingly introduced to the waste while in my custody. The waste transported in this vehicle is the waste identified above, to the best of my knowledge.

[Signature] [Signature] 10-7-10
 Name of Authorized Agent Signature Date Delivered

DISPOSAL SITE INFORMATION

Site Name: Apex Regional Landfill

Phone No. (702) 599-5920

Address: 13550 U.S. Hwy 93 Las Vegas, NV

I hereby acknowledge receipt of the above described materials
[Signature] [Signature] 10-7-10
 Name (Print or Type) Signature Date Received

81 Environmental Tech
13550 N Highway 93
Las Vegas, NV 89165

Ticket Type: INBOUND INVOICE

Ticket Number: 1961
Date: 10/07/2010
Time In: 12:54 pm
Time Out: 1:24 pm

Customer: 001011 - NGE, LLC c/o Northgate Environ Mgmt

Vehicle/Container: 60573P
Contract: Northgate Env. On Site Soils 3825 11
Comment: SR 142& 3825 10 11244

Gross Weight: 128,260 LB Manual In
Tare Weight: 57,960 LB Manual Out
Net Weight: 70300 LB
Net Tons: 35.15

BOL: 1204957010

Origin	Yards	Material	Billing	Quantity
Not Applicable	0.00 YD	SW CONTAMINATED SOIL	35.15	TN

Driver: _____

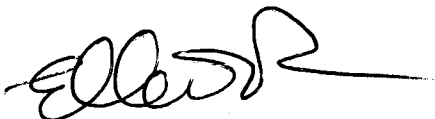

Weighmaster: _____



MORENOJ

Indemnification. Customer agrees, by signature above, to indemnify, hold harmless, and defend Republic Services, Inc., its subsidiaries, affiliates, employees, officers and directors from and against any and all liabilities, claims, penalties, forfeitures, suits and the costs and expenses incident thereto, including costs of defense, settlement, and reasonable attorney's fees, which may be incurred, as a result of death or injuries to any person, or damage to any property, contamination of or adverse effects on the environment, caused in whole or in part by the Customer, its employees, or subcontractors in disposing waste at this Facility. In the event Customer delivers Unacceptable Waste (as determined by Republic) Customer agrees to assume all expenses and obligations with the removal and/or resolution of any effects caused by the delivery of such Unacceptable Waste.

Indemnización. Cliente acuerda indemnizar, mantener inmune, y defender Republic Services, Inc., sus subsidiarios, companias, divisiones, empleados, oficiales y directores contra de cualquiera y de todas responsabilidades, demandas, penas, pérdidas, juicios, pleitos y los costos incidente además, incluyendo costos de defensa, de acuerdo judicial, y de honorarios razonables del abogado, que pueden ser incurridos en, o como resultado de, la muerte o herida personal a cualquier persona, o daños a cualquier característica, propiedad, contaminación de la tierra o efectos ilicitos en esta Facilidad, causado entero o en parte por el cliente, sus empleados, o sus subcontratistas en botar basura en esta Facilidad. En el caso que el Cliente entrega, bota, basura (según lo determinado por Republic) en este Establecimiento basura inaceptable en los reglamentos de este Establecimiento, el Cliente se compromete asumir todos los costos y obligaciones con el retiro y/o la resolución de cualquier dano(s) causado por la entrega de tal basura inaceptable.



NON-HAZARDOUS WASTE MANIFEST

MANIFEST # 12049

GENERATOR INFORMATION

Generator Name: Tronox LLC

Address: P.O. Box 55

City: Henderson County: Clark

State: NV Zip: 89009

Site Location (if different): 560 W. Lake Mead
Henderson, NV 89015 (702) 592-7727

CUSTOMER/BILLING INFORMATION

Billing Name: NGE LLC c/o Northgate Environment Management

Address: 300 Frank Ogawa Plaza, Ste 510

City: Oakland County: Alameda

State: CA Zip: 94612

Table with 5 columns: Republic Services Approval #, Description of Waste, Volume/Weight, Expiration Date, Container Type. Row 1: 38251011244, Soil for disposal, 35.15, 12-31-2011, Tractor with Dump Trailer(s).

*Attach Additional Sheet if necessary

I hereby certify that the above-described materials are non-hazardous wastes as defined by 40 CFR 261 or any applicable state law. Further, that the above named materials are properly classified, described, packaged, marked and labeled, and are in proper condition for transportation according to the applicable regulations of the Department of Transportation.

Susan Crowley (Signature)
Generator/Authorized Agent Name Signature Date Shipped

TRANSPORTER INFORMATION

Transporter Name: Las Vegas Paving

DOT # 191949

Address: 4420 S. Decatur

Truck Number: 142

Las Vegas, NV 89103

Phone Number: (702) 353-4355

I certify no hazardous waste or other regulated substance was knowingly introduced to the waste while in my custody. The waste transported in this vehicle is the waste identified above, to the best of my knowledge.

(Signature)
Name of Authorized Agent Signature Date Delivered 10-7-10

DISPOSAL SITE INFORMATION

Site Name: Apex Regional Landfill

Phone No. (702) 599-5920

Address: 13550 U.S. Hwy 93 Las Vegas, NV

I hereby acknowledge receipt of the above described materials
Juan Moreno (Signature)
Name (Print or Type) Signature Date Received 10-7-10

81 Environmental Tech
13550 N Highway 93
Las Vegas, NV 89165

Ticket Type: INBOUND INVOICE

Ticket Number: 1962
Date: 10/07/2010
Time In: 1:10 pm
Time Out: 1:28 pm

Customer: 001011 - NGE, LLC c/o Northgate Environ Mgmt

Vehicle/Container: 81495P
Contract: Northgate Env. On Site Soils 3825 11
Comment: 145 3825-10-11244

Gross Weight: 116,680 LB Manual In
Tare Weight: 50,180 LB Manual Out
Net Weight: 66500 LB
Net Tons: 33.25

BOL: 12051

Origin	Yards	Material	Billing Quantity
Not Applicable	0.00 YD	SW CONTAMINATED SOIL	33.25 TN

Driver: _____

Weighmaster: _____

IN - WALKERA OUT - MORENOJ

Indemnification. Customer agrees, by signature above, to indemnify, hold harmless, and defend Republic Services, Inc., its subsidiaries, affiliates, employees, officers and directors from and against any and all liabilities, claims, penalties, forfeitures, suits and the costs and expenses incident thereto, including costs of defense, settlement, and reasonable attorney's fees, which may be incurred, as a result of death or injuries to any person, or damage to any property, contamination of or adverse effects on the environment, caused in whole or in part by the Customer, its employees, or subcontractors in disposing waste at this Facility. In the event Customer delivers Unacceptable Waste (as determined by Republic) Customer agrees to assume all expenses and obligations with the removal and/or resolution of any effects caused by the delivery of such Unacceptable Waste.

Indemnización. Cliente acuerda indemnizar, mantener inmune, y defender Republic Services, Inc., sus subsidiarios, compañías, divisiones, empleados, oficiales y directores contra de cualquiera y de todas responsabilidades, demandas, penas, pérdidas, juicios, pleitos y los costos incidente además, incluyendo costos de defensa, de acuerdo judicial, y de honorarios razonables del abogado, que pueden ser incurridos en, o como resultado de, la muerte o herida personal a cualquier persona, o daños a cualquier característica, propiedad, contaminación de la tierra o efectos ilícitos en esta Facilidad, causado entero o en parte por el cliente, sus empleados, o sus subcontratistas en botar basura en esta Facilidad. En el caso que el Cliente entrega, bota, basura (según lo determinado por Republic) en este Establecimiento basura inaceptable en los reglamentos de este Establecimiento, el Cliente se compromete asumir todos los costos y obligaciones con el retiro y/o la resolución de cualquier dano(s) causado por la entrega de tal basura inaceptable.



NON-HAZARDOUS WASTE MANIFEST

MANIFEST # 12051

GENERATOR INFORMATION

Generator Name: Tronox LLC

Address: P.O. Box 55

City: Henderson County: Clark

State: NV Zip: 89009

Site Location (if different): 560 W. Lake Mead

Henderson, NV 89015 (702) 592-7727

CUSTOMER/BILLING INFORMATION

Billing Name: NGE LLC c/o Northgate Environment Management

Address: 300 Frank Ogawa Plaza, Ste 510

City: Oakland County: Alameda

State: CA Zip: 94612

Republic Services Approval #	Description of Waste	Volume/Weight	Expiration Date	Container Type
38251011244	Soil for disposal		12-31-2011	Tractor with Dump Trailer(s)
	RZ- _____ # _____	33.25		

*Attach Additional Sheet if necessary

I hereby certify that the above-described materials are non-hazardous wastes as defined by 40 CFR 261 or any applicable state law. Further, that the above named materials are properly classified, described, packaged, marked and labeled, and are in proper condition for transportation according to the applicable regulations of the Department of Transportation.

Susan Crowley

Susan Crowley

Generator/Authorized Agent Name

Signature

Date Shipped

TRANSPORTER INFORMATION

Transporter Name: Las Vegas Paving

DOT # 191949

Address: 4420 S. Decatur

Truck Number: 145

Las Vegas, NV 89103

Phone Number: (702) 353-4355

I certify no hazardous waste or other regulated substance was knowingly introduced to the waste while in my custody. The waste transported in this vehicle is the waste identified above, to the best of my knowledge.

Name of Authorized Agent

Signature

Date Delivered

10-7-10

DISPOSAL SITE INFORMATION

Site Name: Apex Regional Landfill

Phone No. (702) 599-5920

Address: 13550 U.S. Hwy 93 Las Vegas, NV

I hereby acknowledge receipt of the above described materials

Name (Print or Type)

Signature

Date Received

Juan Moreno

Juan Moreno

10-7-10

81 Environmental Tech
13550 N Highway 93
Las Vegas, NV 89165

Ticket Type: INBOUND INVOICE

Ticket Number: 1963
Date: 10/07/2010
Time In: 1:06 pm
Time Out: 1:34 pm

Customer: 001011 - NGE, LLC c/o Northgate Environ Mgmt

Vehicle/Container: 81496P
Contract: Northgate Env. On Site Soils 3825 11
Comment: 3825 10 11244

Gross Weight: 117,200 LB Manual In
Tare Weight: 50,560 LB Manual Out
Net Weight: 66640 LB
Net Tons: 33.32

BOL: 12052

Origin	Yards	Material	Billing Quantity
Not Applicable	0.00 YD	SW CONTAMINATED SOIL	33.32 TN

Driver: _____

Weighmaster: _____

MORENOJ

Indemnification. Customer agrees, by signature above, to indemnify, hold harmless, and defend Republic Services, Inc., its subsidiaries, affiliates, employees, officers and directors from and against any and all liabilities, claims, penalties, forfeitures, suits and the costs and expenses incident thereto, including costs of defense, settlement, and reasonable attorney's fees, which may be incurred, as a result of death or injuries to any person, or damage to any property, contamination of or adverse effects on the environment, caused in whole or in part by the Customer, its employees, or subcontractors in disposing waste at this Facility. In the event Customer delivers Unacceptable Waste (as determined by Republic) Customer agrees to assume all expenses and obligations with the removal and/or resolution of any effects caused by the delivery of such Unacceptable Waste.

Indemnización. Cliente acuerda indemnizar, mantener inmune, y defender Republic Services, Inc., sus subsidiarios, compañías, divisiones, empleados, oficiales y directores contra de cualquiera y de todas responsabilidades, demandas, penas, pérdidas, juicios, pleitos y los costos incidente además, incluyendo costos de defensa, de acuerdo judicial, y de honorarios razonables del abogado, que pueden ser incurridos en, o como resultado de, la muerte o herida personal a cualquier persona, o daños a cualquier característica, propiedad, contaminación de la tierra o efectos ilícitos en esta Facilidad, causado entero o en parte por el cliente, sus empleados, o sus subcontratistas en botar basura en esta Facilidad. En el caso que el Cliente entrega, bota, basura (según lo determinado por Republic) en este Establecimiento basura inaceptable en los reglamentos de este Establecimiento, el Cliente se compromete asumir todos los costos y obligaciones con el retiro y/o la resolución de cualquier dano(s) causado por la entrega de tal basura inaceptable.



NON-HAZARDOUS WASTE MANIFEST

MANIFEST # 12052

GENERATOR INFORMATION

Generator Name: Tronox LLC

Address: P.O. Box 55

City: Henderson County: Clark

State: NV Zip: 89009

Site Location (if different): 560 W. Lake Mead

Henderson, NV 89015 (702) 592-7727

CUSTOMER/BILLING INFORMATION

Billing Name: NGE LLC c/o Northgate Environment Management

Address: 300 Frank Ogawa Plaza, Ste 510

City: Oakland County: Alameda

State: CA Zip: 94612

Republic Services Approval #	Description of Waste	Volume/Weight	Expiration Date	Container Type
38251011244	Soil for disposal		12-31-2011	Tractor with Dump Trailer(s)
	RZ- _____ # _____	33.32		

*Attach Additional Sheet if necessary

I hereby certify that the above-described materials are non-hazardous wastes as defined by 40 CFR 261 or any applicable state law. Further, that the above named materials are properly classified, described, packaged, marked and labeled, and are in proper condition for transportation according to the applicable regulations of the Department of Transportation.

Susan Crowley (Signature) Generator/Authorized Agent Name Date Shipped

TRANSPORTER INFORMATION

Transporter Name: Las Vegas Paving

DOT # 191949

Address: 4420 S. Decatur

Truck Number: 175

Las Vegas, NV 89103

Phone Number: (702) 353-4355

I certify no hazardous waste or other regulated substance was knowingly introduced to the waste while in my custody. The waste transported in this vehicle is the waste identified above, to the best of my knowledge.

Andrew Walker (Signature) Name of Authorized Agent Date Delivered 10-7-10

DISPOSAL SITE INFORMATION

Site Name: Apex Regional Landfill

Phone No. (702) 599-5920

Address: 13550 U.S. Hwy 93 Las Vegas, NV

Juan Moreno (Signature) Name (Print or Type) Date Received 10-7-10

81 Environmental Tech
13550 N Highway 93
Las Vegas, NV 89165

Ticket Type: INBOUND INVOICE

Ticket Number: 1964
Date: 10/07/2010
Time In: 1:17 pm
Time Out: 1:40 pm

Customer: 001011 - NGE, LLC c/o Northgate Environ Mgmt

Vehicle/Container: 64739P

Contract: Northgate Env. On Site Soils 3825 11

Comment: 106 3825-10-11244

Gross Weight: 120,400 LB Manual In
Tare Weight: 52,040 LB Scale Out
Net Weight: 68360 LB
Net Tons: 34.18

BOL: 12054

Origin	Yards	Material	Billing	Quantity
Not Applicable	0.00 YD	SW CONTAMINATED SOIL	34.18	TN

Driver: _____



Weighmaster: _____



IN - WALKERA OUT - GUILFDE

Indemnification. Customer agrees, by signature above, to indemnify, hold harmless, and defend Republic Services, Inc., its subsidiaries, affiliates, employees, officers and directors from and against any and all liabilities, claims, penalties, forfeitures, suits and the costs and expenses incident thereto, including costs of defense, settlement, and reasonable attorney's fees, which may be incurred, as a result of death or injuries to any person, or damage to any property, contamination of or adverse effects on the environment, caused in whole or in part by the Customer, its employees, or subcontractors in disposing waste at this Facility. In the event Customer delivers Unacceptable Waste (as determined by Republic) Customer agrees to assume all expenses and obligations with the removal and/or resolution of any effects caused by the delivery of such Unacceptable Waste.

Indemnización. Cliente acuerda indemnizar, mantener inmune, y defender Republic Services, Inc., sus subsidiarios, compañías, divisiones, empleados, oficiales y directores contra de cualquiera y de todas responsabilidades, demandas, penas, pérdidas, juicios, pleitos y los costos incidente además, incluyendo costos de defensa, de acuerdo judicial, y de honorarios razonables del abogado, que pueden ser incurridos en, o como resultado de, la muerte o herida personal a cualquier persona, o daños a cualquier característica, propiedad, contaminación de la tierra o efectos ilícitos en esta Facilidad, causado entero o en parte por el cliente, sus empleados, o sus subcontratistas en botar basura en esta Facilidad. En el caso que el Cliente entrega, bota, basura (según lo determinado por Republic) en este Establecimiento basura inaceptable en los reglamentos de este Establecimiento, el Cliente se compromete asumir todos los costos y obligaciones con el retiro y/o la resolución de cualquier dano(s) causado por la entrega de tal basura inaceptable.



NON-HAZARDOUS WASTE MANIFEST

MANIFEST # 12054

GENERATOR INFORMATION

Generator Name: Tronox LLC

Address: P.O. Box 55

City: Henderson County: Clark

State: NV Zip: 89009

Site Location (if different): 560 W. Lake Mead
Henderson, NV 89015 (702) 592-7727

CUSTOMER/BILLING INFORMATION

Billing Name: NGE LLC c/o Northgate Environment Management

Address: 300 Frank Ogawa Plaza, Ste 510

City: Oakland County: Alameda

State: CA Zip: 94612

Table with 5 columns: Republic Services Approval #, Description of Waste, Volume/Weight, Expiration Date, Container Type. Row 1: 38251011244, Soil for disposal, 34.18, 12-31-2011, Tractor with Dump Trailer(s).

*Attach Additional Sheet if necessary

I hereby certify that the above-described materials are non-hazardous wastes as defined by 40 CFR 261 or any applicable state law. Further, that the above named materials are properly classified, described, packaged, marked and labeled, and are in proper condition for transportation according to the applicable regulations of the Department of Transportation.

Susan Crowley (Signature)
Generator/Authorized Agent Name Signature Date Shipped

TRANSPORTER INFORMATION

Transporter Name: Las Vegas Paving DOT # 191949
Address: 4420 S. Decatur Truck Number:
Las Vegas, NV 89103 Phone Number: (702) 353-4355

I certify no hazardous waste or other regulated substance was knowingly introduced to the waste while in my custody. The waste transported in this vehicle is the waste identified above, to the best of my knowledge.

(Signature) 10-7-10
Name of Authorized Agent Signature Date Delivered

DISPOSAL SITE INFORMATION

Site Name: Apex Regional Landfill Phone No. (702) 599-5920
Address: 13550 U.S. Hwy 93 Las Vegas, NV

Debbie Gault (Signature) 10-7-10
Name (Print or Type) Signature Date Received

81 Environmental Tech
13550 N Highway 93
Las Vegas, NV 89165

Ticket Type: INBOUND INVOICE

Ticket Number: 1965
Date: 10/07/2010
Time In: 1:18 pm
Time Out: 1:41 pm

Customer: 001011 - NGE, LLC c/o Northgate Environ Mgmt

Vehicle/Container: 76953P
Contract: Northgate Env. On Site Soils 3825 11
Comment: JH 21 3825-10-11244

Gross Weight: 110,560 LB Scale In
Tare Weight: 54,580 LB Manual Out
Net Weight: 55980 LB
Net Tons: 27.99

BOL: 12053

Origin	Yards	Material	Billing Quantity
Not Applicable	0.00 YD	SW CONTAMINATED SOIL	27.99 TN

Driver: 

Weighmaster: 

IN - WALKERA OUT - GUILFDE

Indemnification. Customer agrees, by signature above, to indemnify, hold harmless, and defend Republic Services, Inc., its subsidiaries, affiliates, employees, officers and directors from and against any and all liabilities, claims, penalties, forfeitures, suits and the costs and expenses incident thereto, including costs of defense, settlement, and reasonable attorney's fees, which may be incurred, as a result of death or injuries to any person, or damage to any property, contamination of or adverse effects on the environment, caused in whole or in part by the Customer, its employees, or subcontractors in disposing waste at this Facility. In the event Customer delivers Unacceptable Waste (as determined by Republic) Customer agrees to assume all expenses and obligations with the removal and/or resolution of any effects caused by the delivery of such Unacceptable Waste.

Indemnización. Cliente acuerda indemnizar, mantener inmune, y defender Republic Services, Inc., sus subsidiarios, compañías, divisiones, empleados, oficiales y directores contra de cualquiera y de todas responsabilidades, demandas, penas, pérdidas, juicios, pleitos y los costos incidente además, incluyendo costos de defensa, de acuerdo judicial, y de honorarios razonables del abogado, que pueden ser incurridos en, o como resultado de, la muerte o herida personal a cualquier persona, o daños a cualquier característica, propiedad, contaminación de la tierra o efectos ilícitos en esta Facilidad, causado entero o en parte por el cliente, sus empleados, o sus subcontratistas en botar basura en esta Facilidad. En el caso que el Cliente entrega, bota, basura (según lo determinado por Republic) en este Establecimiento basura inaceptable en los reglamentos de este Establecimiento, el Cliente se compromete asumir todos los costos y obligaciones con el retiro y/o la resolución de cualquier dano(s) causado por la entrega de tal basura inaceptable.



NON-HAZARDOUS WASTE MANIFEST

MANIFEST # 12053

GENERATOR INFORMATION

Generator Name: Tronox LLC

Address: P.O. Box 55

City: Henderson County: Clark

State: NV Zip: 89009

Site Location (if different): 560 W. Lake Mead
Henderson, NV 89015 (702) 592-7727

CUSTOMER/BILLING INFORMATION

Billing Name: NGE LLC c/o Northgate Environment Management

Address: 300 Frank Ogawa Plaza, Ste 510

City: Oakland County: Alameda

State: CA Zip: 94612

Table with 5 columns: Republic Services Approval #, Description of Waste, Volume/Weight, Expiration Date, Container Type. Row 1: 38251011244, Soil for disposal, 27.99, 12-31-2011, Tractor with Dump Trailer(s).

*Attach Additional Sheet if necessary

I hereby certify that the above-described materials are non-hazardous wastes as defined by 40 CFR 261 or any applicable state law. Further, that the above named materials are properly classified, described, packaged, marked and labeled, and are in proper condition for transportation according to the applicable regulations of the Department of Transportation.

Susan Crowley (Signature)
Generator/Authorized Agent Name Signature Date Shipped

TRANSPORTER INFORMATION

Transporter Name: Las Vegas Paving

DOT # 191949

Address: 4420 S. Decatur

Truck Number: 21

Las Vegas, NV 89103

Phone Number: (702) 353-4355

I certify no hazardous waste or other regulated substance was knowingly introduced to the waste while in my custody. The waste transported in this vehicle is the waste identified above, to the best of my knowledge.

Julio (Signature) 10-7-10 (Date)
Name of Authorized Agent Signature Date Delivered

DISPOSAL SITE INFORMATION

Site Name: Apex Regional Landfill

Phone No. (702) 599-5920

Address: 13550 U.S. Hwy 93 Las Vegas, NV

I hereby acknowledge receipt of the above described materials
Debbie Guilford (Signature) 10-7-10 (Date)
Name (Print or Type) Signature Date Received

81 Environmental Tech
13550 N Highway 93
Las Vegas, NV 89165

Ticket Type: INBOUND INVOICE

Ticket Number: 1966
Date: 10/07/2010
Time In: 1:28 pm
Time Out: 1:54 pm

Customer: 001011 - NGE, LLC c/o Northgate Environ Mgmt

Vehicle/Container: 66925P
Contract: Northgate Env. On Site Soils 3825 11
Comment: 55 3825-10-11244

Gross Weight: 121,160 LB Scale In
Tare Weight: 53,700 LB Scale Out
Net Weight: 67460 LB
Net Tons: 33.73

manifest 12055

Origin	Yards	Material	Billing	Quantity
Not Applicable	0.00 YD	SW CONTAMINATED SOIL	33.73	TN

Driver: _____



Weighmaster: _____



IN - WALKERA OUT - GUILFDE

Indemnification. Customer agrees, by signature above, to indemnify, hold harmless, and defend Republic Services, Inc., its subsidiaries, affiliates, employees, officers and directors from and against any and all liabilities, claims, penalties, forfeitures, suits and the costs and expenses incident thereto, including costs of defense, settlement, and reasonable attorney's fees, which may be incurred, as a result of death or injuries to any person, or damage to any property, contamination of or adverse effects on the environment, caused in whole or in part by the Customer, its employees, or subcontractors in disposing waste at this Facility. In the event Customer delivers Unacceptable Waste (as determined by Republic) Customer agrees to assume all expenses and obligations with the removal and/or resolution of any effects caused by the delivery of such Unacceptable Waste.

Indemnización. Cliente acuerda indemnizar, mantener inmune, y defender Republic Services, Inc., sus subsidiarios, compañías, divisiones, empleados, oficiales y directores contra de cualquiera y de todas responsabilidades, demandas, penas, pérdidas, juicios, pleitos y los costos incidente además, incluyendo costos de defensa, de acuerdo judicial, y de honorarios razonables del abogado, que pueden ser incurridos en, o como resultado de, la muerte o herida personal a cualquier persona, o daños a cualquier característica, propiedad, contaminación de la tierra o efectos ilícitos en esta Facilidad, causado entero o en parte por el cliente, sus empleados, o sus subcontratistas en botar basura en esta Facilidad. En el caso que el Cliente entrega, bota, basura (según lo determinado por Republic) en este Establecimiento basura inaceptable en los reglamentos de este Establecimiento, el Cliente se compromete asumir todos los costos y obligaciones con el retiro y/o la resolución de cualquier dano(s) causado por la entrega de tal basura inaceptable.



NON-HAZARDOUS WASTE MANIFEST

MANIFEST # 12055

GENERATOR INFORMATION

Generator Name: Tronox LLC

Address: P.O. Box 55

City: Henderson County: Clark

State: NV Zip: 89009

Site Location (if different): 560 W. Lake Mead

Henderson, NV 89015 (702) 592-7727

CUSTOMER/BILLING INFORMATION

Billing Name: NGE LLC c/o Northgate Environment Management

Address: 300 Frank Ogawa Plaza, Ste 510

City: Oakland County: Alameda

State: CA Zip: 94612

Table with 5 columns: Republic Services Approval #, Description of Waste, Volume/Weight, Expiration Date, Container Type. Row 1: 38251011244, Soil for disposal, 33.73, 12-31-2011, Tractor with Dump Trailer(s). Row 2: RZ- #

*Attach Additional Sheet if necessary

I hereby certify that the above-described materials are non-hazardous wastes as defined by 40 CFR 261 or any applicable state law. Further, that the above named materials are properly classified, described, packaged, marked and labeled, and are in proper condition for transportation according to the applicable regulations of the Department of Transportation.

Susan Crowley (Signature) Generator/Authorized Agent Name Signature Date Shipped

TRANSPORTER INFORMATION

Transporter Name: Las Vegas Paving DOT # 191949

Address: 4420 S. Decatur Truck Number: 55

Las Vegas, NV 89103 Phone Number: (702) 353-4355

I certify no hazardous waste or other regulated substance was knowingly introduced to the waste while in my custody. The waste transported in this vehicle is the waste identified above, to the best of my knowledge.

Name of Authorized Agent Signature Date Delivered 10-7-10

DISPOSAL SITE INFORMATION

Site Name: Apex Regional Landfill Phone No. (702) 599-5920

Address: 13550 U.S. Hwy 93 Las Vegas, NV

I hereby acknowledge receipt of the above described materials. Debbie Cuffe (Signature) Date Received 10-7-10

81 Environmental Tech
13550 N Highway 93
Las Vegas, NV 89165

Ticket Type: INBOUND INVOICE

Ticket Number: 1967
Date: 10/07/2010
Time In: 1:32 pm
Time Out: 2:00 pm

Customer: 001011 - NGE, LLC c/o Northgate Environ Mgmt

Vehicle/Container: 71893P
Contract: Northgate Env. On Site Soils 3825 11
Comment: JH 7 3825-10-11244

Gross Weight: 131,300 LB Manual In
Tare Weight: 53,380 LB Scale Out
Net Weight: 77920 LB
Net Tons: 38.96

BOL: 12056

Origin	Yards	Material	Billing	Quantity
Not Applicable	0.00 YD	SW CONTAMINATED SOIL	38.96	TN

Driver: _____

Weighmaster: _____

IN - WALKERA OUT - GUILFDE

Indemnification. Customer agrees, by signature above, to indemnify, hold harmless, and defend Republic Services, Inc., its subsidiaries, affiliates, employees, officers and directors from and against any and all liabilities, claims, penalties, forfeitures, suits and the costs and expenses incident thereto, including costs of defense, settlement, and reasonable attorney's fees, which may be incurred, as a result of death or injuries to any person, or damage to any property, contamination of or adverse effects on the environment, caused in whole or in part by the Customer, its employees, or subcontractors in disposing waste at this Facility. In the event Customer delivers Unacceptable Waste (as determined by Republic) Customer agrees to assume all expenses and obligations with the removal and/or resolution of any effects caused by the delivery of such Unacceptable Waste.

Indemnización. Cliente acuerda indemnizar, mantener inmune, y defender Republic Services, Inc., sus subsidiarios, compañías, divisiones, empleados, oficiales y directores contra de cualquiera y de todas responsabilidades, demandas, penas, pérdidas, juicios, pleitos y los costos incidente además, incluyendo costos de defensa, de acuerdo judicial, y de honorarios razonables del abogado, que pueden ser incurridos en, o como resultado de, la muerte o herida personal a cualquier persona, o daños a cualquier característica, propiedad, contaminación de la tierra o efectos ilícitos en esta Facilidad, causado entero o en parte por el cliente, sus empleados, o sus subcontratistas en botar basura en esta Facilidad. En el caso que el Cliente entrega, bota, basura (según lo determinado por Republic) en este Establecimiento basura inaceptable en los reglamentos de este Establecimiento, el Cliente se compromete asumir todos los costos y obligaciones con el retiro y/o la resolución de cualquier dano(s) causado por la entrega de tal basura inaceptable.



NON-HAZARDOUS WASTE MANIFEST

MANIFEST # 12056

GENERATOR INFORMATION

Generator Name: Tronox LLC

Address: P.O. Box 55

City: Henderson County: Clark

State: NV Zip: 89009

Site Location (if different): 560 W. Lake Mead

Henderson, NV 89015 (702) 592-7727

CUSTOMER/BILLING INFORMATION

Billing Name: NGE LLC c/o Northgate Environment Management

Address: 300 Frank Ogawa Plaza, Ste 510

City: Oakland County: Alameda

State: CA Zip: 94612

Republic Services Approval #	Description of Waste	Volume/Weight	Expiration Date	Container Type
38251011244	Soil for disposal		12-31-2011	Tractor with Dump Trailer(s)
	RZ- #	38.96		

*Attach Additional Sheet if necessary

I hereby certify that the above-described materials are non-hazardous wastes as defined by 40 CFR 261 or any applicable state law. Further, that the above named materials are properly classified, described, packaged, marked and labeled, and are in proper condition for transportation according to the applicable regulations of the Department of Transportation.

Susan Crowley Generator/Authorized Agent Name Signature Date Shipped

TRANSPORTER INFORMATION

Transporter Name: Las Vegas Paving

DOT # 191949

Address: 4420 S. Decatur

Truck Number: 7

Las Vegas, NV 89103

Phone Number: (702) 353-4355

I certify no hazardous waste or other regulated substance was knowingly introduced to the waste while in my custody. The waste transported in this vehicle is the waste identified above, to the best of my knowledge.

Name of Authorized Agent Signature Date Delivered 10-7-10

DISPOSAL SITE INFORMATION

Site Name: Apex Regional Landfill

Phone No. (702) 599-5920

Address: 13550 U.S. Hwy 93 Las Vegas, NV

I hereby acknowledge receipt of the above described materials Name (Print or Type) Signature Date Received 10-7-10

REPRINT

81 Environmental Tech
13550 N Highway 93
Las Vegas, NV 89165

Ticket Type: INBOUND INVOICE

Ticket Number: 1968
Date: 10/07/2010
Time In: 1:56 pm
Time Out: 2:16 pm

Customer: 001011 - NGE, LLC c/o Northgate Environ Mgmt

Vehicle/Container: 68628P
Contract: Northgate Env. On Site Soils 3825 11
Comment: RH301 3825-10-11244

Gross Weight: 122,700 LB Scale In
Tare Weight: 54,720 LB Manual Out
Net Weight: 67980 LB
Net Tons: 33.99

BOL: 12057

Origin	Yards	Material	Billing	Quantity
Not Applicable	0.00 YD	SW CONTAMINATED SOIL	33.99	TN

Driver: _____

J S T

Weighmaster: _____



IN - WALKERA OUT - GUILFDE

Indemnification. Customer agrees, by signature above, to indemnify, hold harmless, and defend Republic Services, Inc., its subsidiaries, affiliates, employees, officers and directors from and against any and all liabilities, claims, penalties, forfeitures, suits and the costs and expenses incident thereto, including costs of defense, settlement, and reasonable attorney's fees, which may be incurred, as a result of death or injuries to any person, or damage to any property, contamination of or adverse effects on the environment, caused in whole or in part by the Customer, its employees, or subcontractors in disposing waste at this Facility. In the event Customer delivers Unacceptable Waste (as determined by Republic) Customer agrees to assume all expenses and obligations with the removal and/or resolution of any effects caused by the delivery of such Unacceptable Waste.

Indemnización. Cliente acuerda indemnizar, mantener inmune, y defender Republic Services, Inc., sus subsidiarios, companias, divisiones, empleados, oficiales y directores contra de cualquiera y de todas responsabilidades, demandas, penas, pérdidas, juicios, pleitos y los costos incidente además, incluyendo costos de defensa, de acuerdo judicial, y de honorarios razonables del abogado, que pueden ser incurridos en, o como resultado de, la muerte o herida personal a cualquier persona, o daños a cualquier característica, propiedad, contaminación de la tierra o efectos ilicitos en esta Facilidad, causado entero o en parte por el cliente, sus empleados, o sus subcontratistas en botar basura en esta Facilidad. En el caso que el Cliente entrega, bota, basura (según lo determinado por Republic) en este Establecimiento basura inaceptable en los reglamentos de este Establecimiento, el Cliente se compromete asumir todos los costos y obligaciones con el retiro y/o la resolución de cualquier dano(s) causado por la entrega de tal basura inaceptable.



NON-HAZARDOUS WASTE MANIFEST

MANIFEST # 12057

GENERATOR INFORMATION

Generator Name: Tronox LLC

Address: P.O. Box 55

City: Henderson County: Clark

State: NV Zip: 89009

Site Location (if different): 560 W. Lake Mead

Henderson, NV 89015 (702) 592-7727

CUSTOMER/BILLING INFORMATION

Billing Name: NGE LLC c/o Northgate Environment Management

Address: 300 Frank Ogawa Plaza, Ste 510

City: Oakland County: Alameda

State: CA Zip: 94612

Republic Services Approval #	Description of Waste	Volume/Weight	Expiration Date	Container Type
38251011244	Soil for disposal		12-31-2011	Tractor with Dump Trailer(s)
	RZ- # 33.99 RH301			

*Attach Additional Sheet if necessary

I hereby certify that the above-described materials are non-hazardous wastes as defined by 40 CFR 261 or any applicable state law. Further, that the above named materials are properly classified, described, packaged, marked and labeled, and are in proper condition for transportation according to the applicable regulations of the Department of Transportation.

Susan Crowley

Susan Crowley

Generator/Authorized Agent Name

Signature

Date Shipped

TRANSPORTER INFORMATION

Transporter Name: Las Vegas Paving

DOT # 191949

Address: 4420 S. Decatur

Truck Number: RH301

Las Vegas, NV 89103

Phone Number: (702) 353-4355

I certify no hazardous waste or other regulated substance was knowingly introduced to the waste while in my custody. The waste transported in this vehicle is the waste identified above, to the best of my knowledge.

Name of Authorized Agent

Signature

Date Delivered

10-7-10

DISPOSAL SITE INFORMATION

Site Name: Apex Regional Landfill

Phone No. (702) 599-5920

Address: 13550 U.S. Hwy 93 Las Vegas, NV

I hereby acknowledge receipt of the above described materials

Debbie Gault

Name (Print or Type)

Signature

Date Received

10-7-10

81 Environmental Tech
13550 N Highway 93
Las Vegas, NV 89165

Ticket Type: INBOUND INVOICE

Ticket Number: 1969
Date: 10/07/2010
Time In: 2:00 pm
Time Out: 2:26 pm

Customer: 001011 - NGE, LLC c/o Northgate Environ Mgmt

Vehicle/Container: 85887P
Contract: Northgate Env. On Site Soils 3825 11
Comment: R01 3825-10-11244

Gross Weight: 121,960 LB Manual In
Tare Weight: 51,780 LB Scale Out
Net Weight: 70180 LB
Net Tons: 35.09

BOL: 12058

Origin	Yards	Material	Billing	Quantity
Not Applicable	0.00 YD	SW CONTAMINATED SOIL	35.09	TN

Driver: 

Weighmaster: 

IN - WALKERA OUT - GUILFDE

Indemnification. Customer agrees, by signature above, to indemnify, hold harmless, and defend Republic Services, Inc., its subsidiaries, affiliates, employees, officers and directors from and against any and all liabilities, claims, penalties, forfeitures, suits and the costs and expenses incident thereto, including costs of defense, settlement, and reasonable attorney's fees, which may be incurred, as a result of death or injuries to any person, or damage to any property, contamination of or adverse effects on the environment, caused in whole or in part by the Customer, its employees, or subcontractors in disposing waste at this Facility. In the event Customer delivers Unacceptable Waste (as determined by Republic) Customer agrees to assume all expenses and obligations with the removal and/or resolution of any effects caused by the delivery of such Unacceptable Waste.

Indemnización. Cliente acuerda indemnizar, mantener inmune, y defender Republic Services, Inc., sus subsidiarios, compañías, divisiones, empleados, oficiales y directores contra de cualquiera y de todas responsabilidades, demandas, penas, pérdidas, juicios, pleitos y los costos incidente además, incluyendo costos de defensa, de acuerdo judicial, y de honorarios razonables del abogado, que pueden ser incurridos en, o como resultado de, la muerte o herida personal a cualquier persona, o daños a cualquier característica, propiedad, contaminación de la tierra o efectos ilícitos en esta Facilidad, causado entero o en parte por el cliente, sus empleados, o sus subcontratistas en botar basura en esta Facilidad. En el caso que el Cliente entrega, bota, basura (según lo determinado por Republic) en este Establecimiento basura inaceptable en los reglamentos de este Establecimiento, el Cliente se compromete asumir todos los costos y obligaciones con el retiro y/o la resolución de cualquier dano(s) causado por la entrega de tal basura inaceptable.



NON-HAZARDOUS WASTE MANIFEST

MANIFEST # 12058

GENERATOR INFORMATION

Generator Name: Tronox LLCAddress: P.O. Box 55City: Henderson County: ClarkState: NV Zip: 89009Site Location (if different): 560 W. Lake MeadHenderson, NV 89015 (702) 592-7727

CUSTOMER/BILLING INFORMATION

Billing Name: NGE LLC c/o Northgate Environment ManagementAddress: 300 Frank Ogawa Plaza, Ste 510City: Oakland County: AlamedaState: CA Zip: 94612

Republic Services Approval #	Description of Waste	Volume/Weight	Expiration Date	Container Type
38251011244	Soil for disposal		12-31-2011	Tractor with Dump Trailer(s)
	RZ- _____ # _____	35.09		

*Attach Additional Sheet if necessary

I hereby certify that the above-described materials are non-hazardous wastes as defined by 40 CFR 261 or any applicable state law. Further, that the above named materials are properly classified, described, packaged, marked and labeled, and are in proper condition for transportation according to the applicable regulations of the Department of Transportation.

Susan Crowley
 Generator/Authorized Agent Name

[Signature]
 Signature

Date Shipped

TRANSPORTER INFORMATION

Transporter Name: Las Vegas PavingDOT # 191949Address: 4420 S. DecaturTruck Number: 201Las Vegas, NV 89103Phone Number: (702) 353-4355

I certify no hazardous waste or other regulated substance was knowingly introduced to the waste while in my custody. The waste transported in this vehicle is the waste identified above, to the best of my knowledge.

Name of Authorized Agent

[Signature]
 Signature

Date Delivered

DISPOSAL SITE INFORMATION

Site Name: Apex Regional LandfillPhone No. (702) 599-5920Address: 13550 U.S. Hwy 93 Las Vegas, NV

I hereby acknowledge receipt of the above described materials

Name (Print or Type)

Debbie Gaulton
 Name (Print or Type)

Signature

[Signature]
 Signature

Date Received

10-7-10
 Date Received

81 Environmental Tech
13550 N Highway 93
Las Vegas, NV 89165

Ticket Type: INBOUND INVOICE

Ticket Number: 1970
Date: 10/07/2010
Time In: 2:10 pm
Time Out: 2:35 pm

Customer: 001011 - NGE, LLC c/o Northgate Environ Mgmt

Vehicle/Container: Z009877
Contract: Northgate Env. On Site Soils 3825 11
Comment: 2010 3825-10-11244

Gross Weight: 116,140 LB Manual In
Tare Weight: 48,140 LB Manual Out
Net Weight: 68000 LB
Net Tons: 34.00

BOL: ~~12057~~
12059

Origin	Yards	Material	Billing	Quantity
Not Applicable	0.00 YD	SW CONTAMINATED SOIL	34.00	TN

Driver: _____

Weighmaster: _____

IN - WALKERA OUT - GUILFDE

Indemnification. Customer agrees, by signature above, to indemnify, hold harmless, and defend Republic Services, Inc., its subsidiaries, affiliates, employees, officers and directors from and against any and all liabilities, claims, penalties, forfeitures, suits and the costs and expenses incident thereto, including costs of defense, settlement, and reasonable attorney's fees, which may be incurred, as a result of death or injuries to any person, or damage to any property, contamination of or adverse effects on the environment, caused in whole or in part by the Customer, its employees, or subcontractors in disposing waste at this Facility. In the event Customer delivers Unacceptable Waste (as determined by Republic) Customer agrees to assume all expenses and obligations with the removal and/or resolution of any effects caused by the delivery of such Unacceptable Waste.

Indemnización. Cliente acuerda indemnizar, mantener inmune, y defender Republic Services, Inc., sus subsidiarios, compañías, divisiones, empleados, oficiales y directores contra de cualquiera y de todas responsabilidades, demandas, penas, pérdidas, juicios, pleitos y los costos incidente además, incluyendo costos de defensa, de acuerdo judicial, y de honorarios razonables del abogado, que pueden ser incurridos en, o como resultado de, la muerte o herida personal a cualquier persona, o daños a cualquier característica, propiedad, contaminación de la tierra o efectos ilícitos en esta Facilidad, causado entero o en parte por el cliente, sus empleados, o sus subcontratistas en botar basura en esta Facilidad. En el caso que el Cliente entrega, bota, basura (según lo determinado por Republic) en este Establecimiento basura inaceptable en los reglamentos de este Establecimiento, el Cliente se compromete asumir todos los costos y obligaciones con el retiro y/o la resolución de cualquier dano(s) causado por la entrega de tal basura inaceptable.



NON-HAZARDOUS WASTE MANIFEST

MANIFEST # 12059

GENERATOR INFORMATION

Generator Name: Tronox LLC
Address: P.O. Box 55
City: Henderson County: Clark
State: NV Zip: 89009
Site Location (if different): 560 W. Lake Mead
Henderson, NV 89015 (702) 592-7727

CUSTOMER/BILLING INFORMATION

Billing Name: NGE LLC c/o Northgate Environment Management
Address: 300 Frank Ogawa Plaza, Ste 510
City: Oakland County: Alameda
State: CA Zip: 94612

Table with 5 columns: Republic Services Approval #, Description of Waste, Volume/Weight, Expiration Date, Container Type. Row 1: 38251011244, Soil for disposal, 3400, 12-31-2011, Tractor with Dump Trailer(s).

*Attach Additional Sheet if necessary

I hereby certify that the above-described materials are non-hazardous wastes as defined by 40 CFR 261 or any applicable state law. Further, that the above named materials are properly classified, described, packaged, marked and labeled, and are in proper condition for transportation according to the applicable regulations of the Department of Transportation.

Susan Crowley (Signature)
Generator/Authorized Agent Name Signature Date Shipped

TRANSPORTER INFORMATION

Transporter Name: Las Vegas Paving DOT # 191949
Address: 4420 S. Decatur Truck Number: 2010
Las Vegas, NV 89103 Phone Number: (702) 353-4355

I certify no hazardous waste or other regulated substance was knowingly introduced to the waste while in my custody. The waste transported in this vehicle is the waste identified above, to the best of my knowledge.

(Signature) 10-7-10
Name of Authorized Agent Signature Date Delivered

DISPOSAL SITE INFORMATION

Site Name: Apex Regional Landfill Phone No. (702) 599-5920
Address: 13550 U.S. Hwy 93 Las Vegas, NV

I hereby acknowledge receipt of the above described materials
Debbie Swartz (Signature) 10-7-10
Name (Print or Type) Signature Date Received

81 Environmental Tech
13550 N Highway 93
Las Vegas, NV 89165

Ticket Type: INBOUND INVOICE

Ticket Number: 1971
Date: 10/07/2010
Time In: 2:21 pm
Time Out: 2:48 pm

Customer: 001011 - NGE, LLC c/o Northgate Environ Mgmt

Vehicle/Container: 44164A
Contract: Northgate Env. On Site Soils 3825 11
Comment: K006 3825-10-11244

Gross Weight: 130,960 LB Manual In
Tare Weight: 55,760 LB Manual Out
Net Weight: 75200 LB
Net Tons: 37.60

BOL: 12060

Origin	Yards	Material	Billing	Quantity
Not Applicable	0.00 YD	SW CONTAMINATED SOIL	37.60	TN

Driver: 

Weighmaster: 

IN - WALKERA OUT - GUILFDE

Indemnification. Customer agrees, by signature above, to indemnify, hold harmless, and defend Republic Services, Inc., its subsidiaries, affiliates, employees, officers and directors from and against any and all liabilities, claims, penalties, forfeitures, suits and the costs and expenses incident thereto, including costs of defense, settlement, and reasonable attorney's fees, which may be incurred, as a result of death or injuries to any person, or damage to any property, contamination of or adverse effects on the environment, caused in whole or in part by the Customer, its employees, or subcontractors in disposing waste at this Facility. In the event Customer delivers Unacceptable Waste (as determined by Republic) Customer agrees to assume all expenses and obligations with the removal and/or resolution of any effects caused by the delivery of such Unacceptable Waste.

Indemnización. Cliente acuerda indemnizar, mantener inmune, y defender Republic Services, Inc., sus subsidiarios, compañías, divisiones, empleados, oficiales y directores contra de cualquiera y de todas responsabilidades, demandas, penas, pérdidas, juicios, pleitos y los costos incidente además, incluyendo costos de defensa, de acuerdo judicial, y de honorarios razonables del abogado, que pueden ser incurridos en, o como resultado de, la muerte o herida personal a cualquier persona, o daños a cualquier característica, propiedad, contaminación de la tierra o efectos ilícitos en esta Facilidad, causado entero o en parte por el cliente, sus empleados, o sus subcontratistas en botar basura en esta Facilidad. En el caso que el Cliente entrega, bota, basura (según lo determinado por Republic) en este Establecimiento basura inaceptable en los reglamentos de este Establecimiento, el Cliente se compromete asumir todos los costos y obligaciones con el retiro y/o la resolución de cualquier dano(s) causado por la entrega de tal basura inaceptable.



NON-HAZARDOUS WASTE MANIFEST

MANIFEST # 12060

GENERATOR INFORMATION

Generator Name: Tronox LLC

Address: P.O. Box 55

City: Henderson County: Clark

State: NV Zip: 89009

Site Location (if different): 560 W. Lake Mead
Henderson, NV 89015 (702) 592-7727

CUSTOMER/BILLING INFORMATION

Billing Name: NGE LLC c/o Northgate Environment Management

Address: 300 Frank Ogawa Plaza, Ste 510

City: Oakland County: Alameda

State: CA Zip: 94612

Table with 5 columns: Republic Services Approval #, Description of Waste, Volume/Weight, Expiration Date, Container Type. Row 1: 38251011244, Soil for disposal, 37.60, 12-31-2011, Tractor with Dump Trailer(s).

*Attach Additional Sheet if necessary

I hereby certify that the above-described materials are non-hazardous wastes as defined by 40 CFR 261 or any applicable state law. Further, that the above named materials are properly classified, described, packaged, marked and labeled, and are in proper condition for transportation according to the applicable regulations of the Department of Transportation.

Susan Crowley (Name) Signature (Handwritten) Date Shipped

TRANSPORTER INFORMATION

Transporter Name: Las Vegas Paving

DOT # 191949

Address: 4420 S. Decatur

Truck Number: K-006

Las Vegas, NV 89103

Phone Number: (702) 353-4355

I certify no hazardous waste or other regulated substance was knowingly introduced to the waste while in my custody. The waste transported in this vehicle is the waste identified above, to the best of my knowledge.

Brian Mulvey (Name) Signature (Handwritten) Date Delivered 10-7-10

DISPOSAL SITE INFORMATION

Site Name: Apex Regional Landfill

Phone No. (702) 599-5920

Address: 13550 U.S. Hwy 93 Las Vegas, NV

I hereby acknowledge receipt of the above described materials Debbie Gouttore (Name) Signature (Handwritten) Date Received 10-7-10

81 Environmental Tech
13550 N Highway 93
Las Vegas, NV 89165

Ticket Type: INBOUND INVOICE

Ticket Number: 1972
Date: 10/07/2010
Time In: 2:29 pm
Time Out: 2:57 pm

Customer: 001011 - NGE, LLC c/o Northgate Environ Mgmt

Vehicle/Container: 85914P
Contract: Northgate Env. On Site Soils 3825 11
Comment: DEL 7 3825-10-11244

Gross Weight: 127,060 LB Scale In
Tare Weight: 33,240 LB Manual Out
Net Weight: 93820 LB
Net Tons: 46.91

BOL: 12061

Origin	Yards	Material	Billing	Quantity
Not Applicable	0.00 YD	SW CONTAMINATED SOIL	46.91	TN

Driver: _____

Weighmaster: _____

IN - WALKERA OUT - GUILFDE

Indemnification. Customer agrees, by signature above, to indemnify, hold harmless, and defend Republic Services, Inc., its subsidiaries, affiliates, employees, officers and directors from and against any and all liabilities, claims, penalties, forfeitures, suits and the costs and expenses incident thereto, including costs of defense, settlement, and reasonable attorney's fees, which may be incurred, as a result of death or injuries to any person, or damage to any property, contamination of or adverse effects on the environment, caused in whole or in part by the Customer, its employees, or subcontractors in disposing waste at this Facility. In the event Customer delivers Unacceptable Waste (as determined by Republic) Customer agrees to assume all expenses and obligations with the removal and/or resolution of any effects caused by the delivery of such Unacceptable Waste.

Indemnización. Cliente acuerda indemnizar, mantener inune, y defender Republic Services, Inc., sus subsidiarios, compañías, divisiones, empleados, oficiales y directores contra de cualquiera y de todas responsabilidades, demandas, penas, pérdidas, juicios, pleitos y los costos incidente además, incluyendo costos de defensa, de acuerdo judicial, y de honorarios razonables del abogado, que pueden ser incurridos en, o como resultado de, la muerte o herida personal a cualquier persona, o daños a cualquier característica, propiedad, contaminación de la tierra o efectos ilícitos en esta Facilidad, causado entero o en parte por el cliente, sus empleados, o sus subcontratistas en botar basura en esta Facilidad. En el caso que el Cliente entrega, bota, basura (según lo determinado por Republic) en este Establecimiento basura inaceptable en los reglamentos de este Establecimiento, el Cliente se compromete asumir todos los costos y obligaciones con el retiro y/o la resolución de cualquier dano(s) causado por la entrega de tal basura inaceptable.



NON-HAZARDOUS WASTE MANIFEST MANIFEST # 12061

GENERATOR INFORMATION

Generator Name: Tronox LLC
 Address: P.O. Box 55
 City: Henderson County: Clark
 State: NV Zip: 89009
 Site Location (if different): 560 W. Lake Mead
Henderson, NV 89015 (702) 592-7727

CUSTOMER/BILLING INFORMATION

Billing Name: NGE LLC c/o Northgate Environment Management
 Address: 300 Frank Ogawa Plaza, Ste 510
 City: Oakland County: Alameda
 State: CA Zip: 94612

Republic Services Approval #	Description of Waste	Volume/Weight	Expiration Date	Container Type
38251011244	Soil for disposal		12-31-2011	Tractor with Dump Trailer(s)
	RZ- _____ # _____	46.91		

*Attach Additional Sheet if necessary

I hereby certify that the above-described materials are non-hazardous wastes as defined by 40 CFR 261 or any applicable state law. Further, that the above named materials are properly classified, described, packaged, marked and labeled, and are in proper condition for transportation according to the applicable regulations of the Department of Transportation.

Susan Crowley *Susan Crowley* _____
 Generator/Authorized Agent Name Signature Date Shipped

TRANSPORTER INFORMATION

Transporter Name: Las Vegas Paving DOT # 191949
 Address: 4420 S. Decatur Truck Number: DE7
Las Vegas, NV 89103 Phone Number: (702) 353-4355

I certify no hazardous waste or other regulated substance was knowingly introduced to the waste while in my custody. The waste transported in this vehicle is the waste identified above, to the best of my knowledge.

DAVID DEL CILIO *[Signature]* 10-07-10
 Name of Authorized Agent Signature Date Delivered

DISPOSAL SITE INFORMATION

Site Name: Apex Regional Landfill Phone No. (702) 599-5920
 Address: 13550 U.S. Hwy 93 Las Vegas, NV

I hereby acknowledge receipt of the above described materials
Debbie Guilfoyle *[Signature]* 10-7-10
 Name (Print or Type) Signature Date Received

81 Environmental Tech
13550 N Highway 93
Las Vegas, NV 89165

Ticket Type: INBOUND INVOICE

Ticket Number: 1973
Date: 10/07/2010
Time In: 2:31 pm
Time Out: 3:00 pm

Customer: 001011 - NGE, LLC c/o Northgate Environ Mgmt

Vehicle/Container: 82515P
Contract: Northgate Env. On Site Soils 3825 11
Comment: 3825-10-11244

Gross Weight: 135,760 LB Manual In
Tare Weight: 52,600 LB Manual Out
Net Weight: 83160 LB
Net Tons: 41.58

BOL: 12062

Origin	Yards	Material	Billing	Quantity
Not Applicable	0.00 YD	SW CONTAMINATED SOIL	41.58	TN

Driver: _____

Weighmaster: _____

IN - WALKERA OUT - GUILFDE

Indemnification. Customer agrees, by signature above, to indemnify, hold harmless, and defend Republic Services, Inc., its subsidiaries, affiliates, employees, officers and directors from and against any and all liabilities, claims, penalties, forfeitures, suits and the costs and expenses incident thereto, including costs of defense, settlement, and reasonable attorney's fees, which may be incurred, as a result of death or injuries to any person, or damage to any property, contamination of or adverse effects on the environment, caused in whole or in part by the Customer, its employees, or subcontractors in disposing waste at this Facility. In the event Customer delivers Unacceptable Waste (as determined by Republic) Customer agrees to assume all expenses and obligations with the removal and/or resolution of any effects caused by the delivery of such Unacceptable Waste.

Indemnización. Cliente acuerda indemnizar, mantener inmune, y defender Republic Services, Inc., sus subsidiarios, compañías, divisiones, empleados, oficiales y directores contra de cualquiera y de todas responsabilidades, demandas, penas, pérdidas, juicios, pleitos y los costos incidente además, incluyendo costos de defensa, de acuerdo judicial, y de honorarios razonables del abogado, que pueden ser incurridos en, o como resultado de, la muerte o herida personal a cualquier persona, o daños a cualquier característica, propiedad, contaminación de la tierra o efectos ilícitos en esta Facilidad, causado entero o en parte por el cliente, sus empleados, o sus subcontratistas en botar basura en esta Facilidad. En el caso que el Cliente entrega, bota, basura (según lo determinado por Republic) en este Establecimiento basura inaceptable en los reglamentos de este Establecimiento, el Cliente se compromete asumir todos los costos y obligaciones con el retiro y/o la resolución de cualquier dano(s) causado por la entrega de tal basura inaceptable.



NON-HAZARDOUS WASTE MANIFEST

MANIFEST # 12062

GENERATOR INFORMATION

Generator Name: Tronox LLC

Address: P.O. Box 55

City: Henderson County: Clark

State: NV Zip: 89009

Site Location (if different): 560 W. Lake Mead

Henderson, NV 89015 (702) 592-7727

CUSTOMER/BILLING INFORMATION

Billing Name: NGE LLC c/o Northgate Environment Management

Address: 300 Frank Ogawa Plaza, Ste 510

City: Oakland County: Alameda

State: CA Zip: 94612

Republic Services Approval #	Description of Waste	Volume/Weight	Expiration Date	Container Type
38251011244	Soil for disposal		12-31-2011	Tractor with Dump Trailer(s)
	RZ- #	41.58		

*Attach Additional Sheet if necessary

I hereby certify that the above-described materials are non-hazardous wastes as defined by 40 CFR 261 or any applicable state law. Further, that the above named materials are properly classified, described, packaged, marked and labeled, and are in proper condition for transportation according to the applicable regulations of the Department of Transportation.

Susan Crowley Generator/Authorized Agent Name Signature Date Shipped

TRANSPORTER INFORMATION

Transporter Name: Las Vegas Paving DOT # 191949

Address: 4420 S. Decatur Truck Number:

Las Vegas, NV 89103 Phone Number: (702) 353-4355

I certify no hazardous waste or other regulated substance was knowingly introduced to the waste while in my custody. The waste transported in this vehicle is the waste identified above, to the best of my knowledge.

Name of Authorized Agent Signature Date Delivered

DISPOSAL SITE INFORMATION

Site Name: Apex Regional Landfill Phone No. (702) 599-5920

Address: 13550 U.S. Hwy 93 Las Vegas, NV

I hereby acknowledge receipt of the above described materials Name (Print or Type) Signature Date Received

81 Environmental Tech
13550 N Highway 93
Las Vegas, NV 89165

Ticket Type: INBOUND INVOICE

Ticket Number: 1974
Date: 10/07/2010
Time In: 3:03 pm
Time Out: 3:22 pm

Customer: 001011 - NGE, LLC c/o Northgate Environ Mgmt

Vehicle/Container: 73072P
Contract: Northgate Env. On Site Soils 3825 11
Comment: 3825-10-11244

Gross Weight: 123,900 LB Manual In
Tare Weight: 50,780 LB Manual Out
Net Weight: 73120 LB
Net Tons: 36.56

BOL: 12064

Origin	Yards	Material	Billing	Quantity
Not Applicable	0.00 YD	SW CONTAMINATED SOIL	36.56 TN	

Driver: 

Weighmaster: 

IN - WALKERA OUT - GUILFDE

Indemnification. Customer agrees, by signature above, to indemnify, hold harmless, and defend Republic Services, Inc., its subsidiaries, affiliates, employees, officers and directors from and against any and all liabilities, claims, penalties, forfeitures, suits and the costs and expenses incident thereto, including costs of defense, settlement, and reasonable attorney's fees, which may be incurred, as a result of death or injuries to any person, or damage to any property, contamination of or adverse effects on the environment, caused in whole or in part by the Customer, its employees, or subcontractors in disposing waste at this Facility. In the event Customer delivers Unacceptable Waste (as determined by Republic) Customer agrees to assume all expenses and obligations with the removal and/or resolution of any effects caused by the delivery of such Unacceptable Waste.

Indemnización. Cliente acuerda indemnizar, mantener inmune, y defender Republic Services, Inc., sus subsidiarios, compañías, divisiones, empleados, oficiales y directores contra de cualquiera y de todas responsabilidades, demandas, penas, pérdidas, juicios, pleitos y los costos incidente además, incluyendo costos de defensa, de acuerdo judicial, y de honorarios razonables del abogado, que pueden ser incurridos en, o como resultado de, la muerte o herida personal a cualquier persona, o daños a cualquier característica, propiedad, contaminación de la tierra o efectos ilícitos en esta Facilidad, causado entero o en parte por el cliente, sus empleados, o sus subcontratistas en botar basura en esta Facilidad. En el caso que el Cliente entrega, bota, basura (según lo determinado por Republic) en este Establecimiento basura inaceptable en los reglamentos de este Establecimiento, el Cliente se compromete asumir todos los costos y obligaciones con el retiro y/o la resolución de cualquier dano(s) causado por la entrega de tal basura inaceptable.



NON-HAZARDOUS WASTE MANIFEST

MANIFEST # 12064

GENERATOR INFORMATION

Generator Name: Tronox LLC

Address: P.O. Box 55

City: Henderson County: Clark

State: NV Zip: 89009

Site Location (if different): 560 W. Lake Mead

Henderson, NV 89015 (702) 592-7727

CUSTOMER/BILLING INFORMATION

Billing Name: NGE LLC c/o Northgate Environment Management

Address: 300 Frank Ogawa Plaza, Ste 510

City: Oakland County: Alameda

State: CA Zip: 94612

Republic Services Approval #	Description of Waste	Volume/Weight	Expiration Date	Container Type
38251011244	Soil for disposal		12-31-2011	Tractor with Dump Trailer(s)
	RZ- #	36.56		

*Attach Additional Sheet if necessary

I hereby certify that the above-described materials are non-hazardous wastes as defined by 40 CFR 261 or any applicable state law. Further, that the above named materials are properly classified, described, packaged, marked and labeled, and are in proper condition for transportation according to the applicable regulations of the Department of Transportation.

Susan Crowley Generator/Authorized Agent Name Signature Date Shipped 10-7-10

TRANSPORTER INFORMATION

Transporter Name: Las Vegas Paving DOT # 191949

Address: 4420 S. Decatur Truck Number:

Las Vegas, NV 89103 Phone Number: (702) 353-4355

I certify no hazardous waste or other regulated substance was knowingly introduced to the waste while in my custody. The waste transported in this vehicle is the waste identified above, to the best of my knowledge.

Robert Name of Authorized Agent Signature Date Delivered 10-7-10

DISPOSAL SITE INFORMATION

Site Name: Apex Regional Landfill Phone No. (702) 599-5920

Address: 13550 U.S. Hwy 93 Las Vegas, NV

I hereby acknowledge receipt of the above described materials Debbie Couture Signature Date Received 10-7-10

81 Environmental Tech
13550 N Highway 93
Las Vegas, NV 89165

Ticket Type: INBOUND INVOICE

Ticket Number: 1975
Date: 10/07/2010
Time In: 3:05 pm
Time Out: 3:28 pm

Customer: 001011 - NGE, LLC c/o Northgate Environ Mgmt

Vehicle/Container: 29573A
Contract: Northgate Env. On Site Soils 3825 11
Comment: 3825-10-11244

Gross Weight: 134,240 LB Manual In
Tare Weight: 54,800 LB Manual Out
Net Weight: 79440 LB
Net Tons: 39.72

BOL: 12065

Origin	Yards	Material	Billing	Quantity
Not Applicable	0.00 YD	SW CONTAMINATED SOIL	39.72	TN

Driver: _____

Weighmaster: _____

IN - WALKERA OUT - GUILFDE

Indemnification. Customer agrees, by signature above, to indemnify, hold harmless, and defend Republic Services, Inc., its subsidiaries, affiliates, employees, officers and directors from and against any and all liabilities, claims, penalties, forfeitures, suits and the costs and expenses incident thereto, including costs of defense, settlement, and reasonable attorney's fees, which may be incurred, as a result of death or injuries to any person, or damage to any property, contamination of or adverse effects on the environment, caused in whole or in part by the Customer, its employees, or subcontractors in disposing waste at this Facility. In the event Customer delivers Unacceptable Waste (as determined by Republic) Customer agrees to assume all expenses and obligations with the removal and/or resolution of any effects caused by the delivery of such Unacceptable Waste.

Indemnización. Cliente acuerda indemnizar, mantener inmune, y defender Republic Services, Inc., sus subsidiarios, compañías, divisiones, empleados, oficiales y directores contra de cualquiera y de todas responsabilidades, demandas, penas, pérdidas, juicios, pleitos y los costos incidente además, incluyendo costos de defensa, de acuerdo judicial, y de honorarios razonables del abogado, que pueden ser incurridos en, o como resultado de, la muerte o herida personal a cualquier persona, o daños a cualquier característica, propiedad, contaminación de la tierra o efectos ilícitos en esta Facilidad, causado entero o en parte por el cliente, sus empleados, o sus subcontratistas en botar basura en esta Facilidad. En el caso que el Cliente entrega, bota, basura (según lo determinado por Republic) en este Establecimiento basura inaceptable en los reglamentos de este Establecimiento, el Cliente se compromete asumir todos los costos y obligaciones con el retiro y/o la resolución de cualquier dano(s) causado por la entrega de tal basura inaceptable.



NON-HAZARDOUS WASTE MANIFEST

MANIFEST # 12065

GENERATOR INFORMATION

Generator Name: Tronox LLC
Address: P.O. Box 55
City: Henderson County: Clark
State: NV Zip: 89009
Site Location (if different): 560 W. Lake Mead
Henderson, NV 89015 (702) 592-7727

CUSTOMER/BILLING INFORMATION

Billing Name: NGE LLC c/o Northgate Environment Management
Address: 300 Frank Ogawa Plaza, Ste 510
City: Oakland County: Alameda
State: CA Zip: 94612

Table with 5 columns: Republic Services Approval #, Description of Waste, Volume/Weight, Expiration Date, Container Type. Row 1: 38251011244, Soil for disposal, 39.72, 12-31-2011, Tractor with Dump Trailer(s).

*Attach Additional Sheet if necessary

I hereby certify that the above-described materials are non-hazardous wastes as defined by 40 CFR 261 or any applicable state law. Further, that the above named materials are properly classified, described, packaged, marked and labeled, and are in proper condition for transportation according to the applicable regulations of the Department of Transportation.

Susan Crowley
Generator/Authorized Agent Name Signature Date Shipped

TRANSPORTER INFORMATION

Transporter Name: Las Vegas Paving DOT # 191949
Address: 4420 S. Decatur Truck Number: 17
Las Vegas, NV 89103 Phone Number: (702) 353-4355

I certify no hazardous waste or other regulated substance was knowingly introduced to the waste while in my custody. The waste transported in this vehicle is the waste identified above, to the best of my knowledge.

Name of Authorized Agent Signature Date Delivered 10-7-10

DISPOSAL SITE INFORMATION

Site Name: Apex Regional Landfill Phone No. (702) 599-5920
Address: 13550 U.S. Hwy 93 Las Vegas, NV

I hereby acknowledge receipt of the above described materials
Debbie Sultaire Signature Date Received 10-7-10

81 Environmental Tech
13550 N Highway 93
Las Vegas, NV 89165

Ticket Type: INBOUND INVOICE

Ticket Number: 1976
Date: 10/07/2010
Time In: 3:13 pm
Time Out: 3:40 pm

Customer: 001011 - NGE, LLC c/o Northgate Environ Mgmt

Vehicle/Container: 44165A
Contract: Northgate Env. On Site Soils 3825 1/
Comment: 3825-10-11244

Gross Weight: 122,000 LB Manual In
Tare Weight: 51,980 LB Manual Out
Net Weight: 70020 LB
Net Tons: 35.01

BOL: 12066

Origin	Yards	Material	Billing	Quantity
Not Applicable	0.00 YD	SW CONTAMINATED SOIL	35.01 TN	

Driver: _____

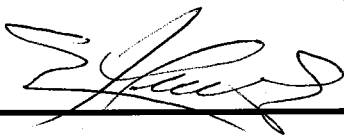

Weighmaster: _____

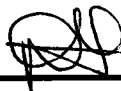

GUILFDE

Indemnification. Customer agrees, by signature above, to indemnify, hold harmless, and defend Republic Services, Inc., its subsidiaries, affiliates, employees, officers and directors from and against any and all liabilities, claims, penalties, forfeitures, suits and the costs and expenses incident thereto, including costs of defense, settlement, and reasonable attorney's fees, which may be incurred, as a result of death or injuries to any person, or damage to any property, contamination of or adverse effects on the environment, caused in whole or in part by the Customer, its employees, or subcontractors in disposing waste at this Facility. In the event Customer delivers Unacceptable Waste (as determined by Republic) Customer agrees to assume all expenses and obligations with the removal and/or resolution of any effects caused by the delivery of such Unacceptable Waste.

Indemnización. Cliente acuerda indemnizar, mantener inmune, y defender Republic Services, Inc., sus subsidiarios, compañías, divisiones, empleados, oficiales y directores contra de cualquiera y de todas responsabilidades, demandas, penas, pérdidas, juicios, pleitos y los costos incidente además, incluyendo costos de defensa, de acuerdo judicial, y de honorarios razonables del abogado, que pueden ser incurridos en, o como resultado de, la muerte o herida personal a cualquier persona, o daños a cualquier característica, propiedad, contaminación de la tierra o efectos ilícitos en esta Facilidad, causado entero o en parte por el cliente, sus empleados, o sus subcontratistas en botar basura en esta Facilidad. En el caso que el Cliente entrega, bota, basura (según lo determinado por Republic) en este Establecimiento basura inaceptable en los reglamentos de este Establecimiento, el Cliente se compromete asumir todos los costos y obligaciones con el retiro y/o la resolución de cualquier dano(s) causado por la entrega de tal basura inaceptable.



NON-HAZARDOUS WASTE MANIFEST

MANIFEST # 12066

GENERATOR INFORMATION

Generator Name: Tronox LLC

Address: P.O. Box 55

City: Henderson County: Clark

State: NV Zip: 89009

Site Location (if different): 560 W. Lake Mead
Henderson, NV 89015 (702) 592-7727

CUSTOMER/BILLING INFORMATION

Billing Name: NGE LLC c/o Northgate Environment Management

Address: 300 Frank Ogawa Plaza, Ste 510

City: Oakland County: Alameda

State: CA Zip: 94612

Republic Services Approval #	Description of Waste	Volume/Weight	Expiration Date	Container Type
38251011244	Soil for disposal		12-31-2011	Tractor with Dump Trailer(s)
	RZ- _____ # _____	35.01		

*Attach Additional Sheet if necessary

I hereby certify that the above-described materials are non-hazardous wastes as defined by 40 CFR 261 or any applicable state law. Further, that the above named materials are properly classified, described, packaged, marked and labeled, and are in proper condition for transportation according to the applicable regulations of the Department of Transportation.

Susan Crowley  _____
 Generator/Authorized Agent Name Signature Date Shipped

TRANSPORTER INFORMATION

Transporter Name: Las Vegas Paving

DOT # 191949

Address: 4420 S. Decatur

Truck Number: K005

Las Vegas, NV 89103

Phone Number: (702) 353-4355

I certify no hazardous waste or other regulated substance was knowingly introduced to the waste while in my custody. The waste transported in this vehicle is the waste identified above, to the best of my knowledge.

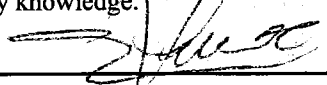
_____  _____
 Name of Authorized Agent Signature Date Delivered 10-7-10

DISPOSAL SITE INFORMATION

Site Name: Apex Regional Landfill

Phone No. (702) 599-5920

Address: 13550 U.S. Hwy 93 Las Vegas, NV

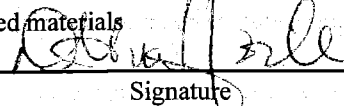
I hereby acknowledge receipt of the above described materials
Debbie Cantore  _____
 Name (Print or Type) Signature Date Received 10-7-10

81 Environmental Tech
13550 N Highway 93
Las Vegas, NV 89165

Ticket Type: INBOUND INVOICE

Ticket Number: 1977
Date: 10/07/2010
Time In: 3:18 pm
Time Out: 3:43 pm

Customer: 001011 - NGE, LLC c/o Northgate Environ Mgmt

Vehicle/Container: 60573P
Contract: Northgate Env. On Site Soils 3825 11
Comment: 3825-10-11244

Gross Weight: 128,380 LB Manual In
Tare Weight: 57,600 LB Manual Out
Net Weight: 70780 LB
Net Tons: 35.39

BOL: 12068

Origin	Yards	Material	Billing	Quantity
Not Applicable	0.00 YD	SW CONTAMINATED SOIL	35.39	TN

Driver: _____



Weighmaster: _____



IN - WALKERA OUT - GUILFDE

Indemnification. Customer agrees, by signature above, to indemnify, hold harmless, and defend Republic Services, Inc., its subsidiaries, affiliates, employees, officers and directors from and against any and all liabilities, claims, penalties, forfeitures, suits and the costs and expenses incident thereto, including costs of defense, settlement, and reasonable attorney's fees, which may be incurred, as a result of death or injuries to any person, or damage to any property, contamination of or adverse effects on the environment, caused in whole or in part by the Customer, its employees, or subcontractors in disposing waste at this Facility. In the event Customer delivers Unacceptable Waste (as determined by Republic) Customer agrees to assume all expenses and obligations with the removal and/or resolution of any effects caused by the delivery of such Unacceptable Waste.

Indemnización. Cliente acuerda indemnizar, mantener inmune, y defender Republic Services, Inc., sus subsidiarios, compañías, divisiones, empleados, oficiales y directores contra de cualquiera y de todas responsabilidades, demandas, penas, pérdidas, juicios, pleitos y los costos incidente además, incluyendo costos de defensa, de acuerdo judicial, y de honorarios razonables del abogado, que pueden ser incurridos en, o como resultado de, la muerte o herida personal a cualquier persona, o daños a cualquier característica, propiedad, contaminación de la tierra o efectos ilícitos en esta Facilidad, causado entero o en parte por el cliente, sus empleados, o sus subcontratistas en botar basura en esta Facilidad. En el caso que el Cliente entrega, bota, basura (según lo determinado por Republic) en este Establecimiento basura inaceptable en los reglamentos de este Establecimiento, el Cliente se compromete asumir todos los costos y obligaciones con el retiro y/o la resolución de cualquier dano(s) causado por la entrega de tal basura inaceptable.



NON-HAZARDOUS WASTE MANIFEST

MANIFEST # 12068

GENERATOR INFORMATION

Generator Name: Tronox LLC
Address: P.O. Box 55
City: Henderson County: Clark
State: NV Zip: 89009
Site Location (if different): 560 W. Lake Mead
Henderson, NV 89015 (702) 592-7727

CUSTOMER/BILLING INFORMATION

Billing Name: NGE LLC c/o Northgate Environment Management
Address: 300 Frank Ogawa Plaza, Ste 510
City: Oakland County: Alameda
State: CA Zip: 94612

Table with 5 columns: Republic Services Approval #, Description of Waste, Volume/Weight, Expiration Date, Container Type. Row 1: 38251011244, Soil for disposal, 35.39, 12-31-2011, Tractor with Dump Trailer(s).

*Attach Additional Sheet if necessary

I hereby certify that the above-described materials are non-hazardous wastes as defined by 40 CFR 261 or any applicable state law. Further, that the above named materials are properly classified, described, packaged, marked and labeled, and are in proper condition for transportation according to the applicable regulations of the Department of Transportation.

Susan Crowley (Signature) Date Shipped
Generator/Authorized Agent Name Signature Date Shipped

TRANSPORTER INFORMATION

Transporter Name: Las Vegas Paving DOT # 191949
Address: 4420 S. Decatur Truck Number: 142
Las Vegas, NV 89103 Phone Number: (702) 353-4355

I certify no hazardous waste or other regulated substance was knowingly introduced to the waste while in my custody. The waste transported in this vehicle is the waste identified above, to the best of my knowledge.

(Signature) Date Delivered 10-7-10
Name of Authorized Agent Signature Date Delivered

DISPOSAL SITE INFORMATION

Site Name: Apex Regional Landfill Phone No. (702) 599-5920
Address: 13550 U.S. Hwy 93 Las Vegas, NV

I hereby acknowledge receipt of the above described materials
Debbie Guitford (Signature) Date Received 10-7-10
Name (Print or Type) Signature Date Received

81 Environmental Tech
13550 N Highway 93
Las Vegas, NV 89165

Ticket Type: INBOUND INVOICE

Ticket Number: 1978
Date: 10/07/2010
Time In: 3:14 pm
Time Out: 3:45 pm

Customer: 001011 - NGE, LLC c/o Northgate Environ Mgmt

Vehicle/Container: 81494P
Contract: Northgate Env. On Site Soils 3825 11
Comment: 3825-10-11244

Gross Weight: 121,960 LB Manual In
Tare Weight: 51,580 LB Manual Out
Net Weight: 70380 LB
Net Tons: 35.19

BOL: 12067

Origin	Yards	Material	Billing Quantity
Not Applicable	0.00 YD	SW CONTAMINATED SOIL	35.19 TN

Driver: _____

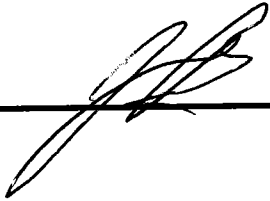

Weighmaster: _____



IN - WALKERA OUT - GUILFDE

Indemnification. Customer agrees, by signature above, to indemnify, hold harmless, and defend Republic Services, Inc., its subsidiaries, affiliates, employees, officers and directors from and against any and all liabilities, claims, penalties, forfeitures, suits and the costs and expenses incident thereto, including costs of defense, settlement, and reasonable attorney's fees, which may be incurred, as a result of death or injuries to any person, or damage to any property, contamination of or adverse effects on the environment, caused in whole or in part by the Customer, its employees, or subcontractors in disposing waste at this Facility. In the event Customer delivers Unacceptable Waste (as determined by Republic) Customer agrees to assume all expenses and obligations with the removal and/or resolution of any effects caused by the delivery of such Unacceptable Waste.

Indemnización. Cliente acuerda indemnizar, mantener inmune, y defender Republic Services, Inc., sus subsidiarios, compañías, divisiones, empleados, oficiales y directores contra de cualquiera y de todas responsabilidades, demandas, penas, pérdidas, juicios, pleitos y los costos incidente además, incluyendo costos de defensa, de acuerdo judicial, y de honorarios razonables del abogado, que pueden ser incurridos en, o como resultado de, la muerte o herida personal a cualquier persona, o daños a cualquier característica, propiedad, contaminación de la tierra o efectos ilícitos en esta Facilidad, causado entero o en parte por el cliente, sus empleados, o sus subcontratistas en botar basura en esta Facilidad. En el caso que el Cliente entrega, bota, basura (según lo determinado por Republic) en este Establecimiento basura inaceptable en los reglamentos de este Establecimiento, el Cliente se compromete asumir todos los costos y obligaciones con el retiro y/o la resolución de cualquier dano(s) causado por la entrega de tal basura inaceptable.



NON-HAZARDOUS WASTE MANIFEST

MANIFEST # 12067

GENERATOR INFORMATION

Generator Name: Tronox LLC

Address: P.O. Box 55

City: Henderson County: Clark

State: NV Zip: 89009

Site Location (if different): 560 W. Lake Mead
Henderson, NV 89015 (702) 592-7727

CUSTOMER/BILLING INFORMATION

Billing Name: NGE LLC c/o Northgate Environment Management

Address: 300 Frank Ogawa Plaza, Ste 510

City: Oakland County: Alameda

State: CA Zip: 94612

Table with 5 columns: Republic Services Approval #, Description of Waste, Volume/Weight, Expiration Date, Container Type. Row 1: 38251011244, Soil for disposal, 35.19, 12-31-2011, Tractor with Dump Trailer(s). Row 2: RZ- #

*Attach Additional Sheet if necessary

I hereby certify that the above-described materials are non-hazardous wastes as defined by 40 CFR 261 or any applicable state law. Further, that the above named materials are properly classified, described, packaged, marked and labeled, and are in proper condition for transportation according to the applicable regulations of the Department of Transportation.

Susan Crowley
Generator/Authorized Agent Name Signature Date Shipped

TRANSPORTER INFORMATION

Transporter Name: Las Vegas Paving DOT # 191949

Address: 4420 S. Decatur Truck Number: 125

Las Vegas, NV 89103 Phone Number: (702) 353-4355

I certify no hazardous waste or other regulated substance was knowingly introduced to the waste while in my custody. The waste transported in this vehicle is the waste identified above, to the best of my knowledge.

J Bowyer
Name of Authorized Agent Signature Date Delivered 10-7-10

DISPOSAL SITE INFORMATION

Site Name: Apex Regional Landfill Phone No. (702) 599-5920

Address: 13550 U.S. Hwy 93 Las Vegas, NV

Debbie Guitton
Name (Print or Type) Signature Date Received 10-7-10

81 Environmental Tech
13550 N Highway 93
Las Vegas, NV 89165

Ticket Type: INBOUND INVOICE

Ticket Number: 1979
Date: 10/07/2010
Time In: 3:24 pm
Time Out: 3:50 pm

Customer: 001011 - NGE, LLC c/o Northgate Environ Mgmt

Vehicle/Container: 81496P
Contract: Northgate Env. On Site Soils 3825 11
Comment: 3825-10-11244

Gross Weight: 117,320 LB Manual In
Tare Weight: 50,660 LB Manual Out
Net Weight: 66660 LB
Net Tons: 33.33

BOL: 12069

Origin	Yards	Material	Billing	Quantity
Not Applicable	0.00 YD	SW CONTAMINATED SOIL	33.33	TN

Driver: _____



Weighmaster: _____

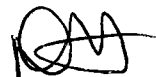

IN - WALKERA OUT - CARTERJ

Indemnification. Customer agrees, by signature above, to indemnify, hold harmless, and defend Republic Services, Inc., its subsidiaries, affiliates, employees, officers and directors from and against any and all liabilities, claims, penalties, forfeitures, suits and the costs and expenses incident thereto, including costs of defense, settlement, and reasonable attorney's fees, which may be incurred, as a result of death or injuries to any person, or damage to any property, contamination of or adverse effects on the environment, caused in whole or in part by the Customer, its employees, or subcontractors in disposing waste at this Facility. In the event Customer delivers Unacceptable Waste (as determined by Republic) Customer agrees to assume all expenses and obligations with the removal and/or resolution of any effects caused by the delivery of such Unacceptable Waste.

Indemnización. Cliente acuerda indemnizar, mantener inmune, y defender Republic Services, Inc., sus subsidiarios, compañías, divisiones, empleados, oficiales y directores contra de cualquiera y de todas responsabilidades, demandas, penas, pérdidas, juicios, pleitos y los costos incidente además, incluyendo costos de defensa, de acuerdo judicial, y de honorarios razonables del abogado, que pueden ser incurridos en, o como resultado de, la muerte o herida personal a cualquier persona, o daños a cualquier característica, propiedad, contaminación de la tierra o efectos ilícitos en esta Facilidad, causado entero o en parte por el cliente, sus empleados, o sus subcontratistas en botar basura en esta Facilidad. En el caso que el Cliente entrega, bota, basura (según lo determinado por Republic) en este Establecimiento basura inaceptable en los reglamentos de este Establecimiento, el Cliente se compromete asumir todos los costos y obligaciones con el retiro y/o la resolución de cualquier dano(s) causado por la entrega de tal basura inaceptable.



NON-HAZARDOUS WASTE MANIFEST

MANIFEST # 12069

GENERATOR INFORMATION

Generator Name: Tronox LLC

Address: P.O. Box 55

City: Henderson County: Clark

State: NV Zip: 89009

Site Location (if different): 560 W. Lake Mead

Henderson, NV 89015 (702) 592-7727

CUSTOMER/BILLING INFORMATION

Billing Name: NGE LLC c/o Northgate Environment Management

Address: 300 Frank Ogawa Plaza, Ste 510

City: Oakland County: Alameda

State: CA Zip: 94612

Republic Services Approval #	Description of Waste	Volume/Weight	Expiration Date	Container Type
38251011244	Soil for disposal	33.33 TN	12-31-2011	Tractor with Dump Trailer(s)
	RZ- #			

*Attach Additional Sheet if necessary

I hereby certify that the above-described materials are non-hazardous wastes as defined by 40 CFR 261 or any applicable state law. Further, that the above named materials are properly classified, described, packaged, marked and labeled, and are in proper condition for transportation according to the applicable regulations of the Department of Transportation.

Susan Crowley
Generator/Authorized Agent Name
Signature
Date Shipped

TRANSPORTER INFORMATION

Transporter Name: Las Vegas Paving

DOT # 191949

Address: 4420 S. Decatur

Truck Number: 145

Las Vegas, NV 89103

Phone Number: (702) 353-4355

I certify no hazardous waste or other regulated substance was knowingly introduced to the waste while in my custody. The waste transported in this vehicle is the waste identified above, to the best of my knowledge.

Name of Authorized Agent
Signature
Date Delivered: 10-7-10

DISPOSAL SITE INFORMATION

Site Name: Apex Regional Landfill

Phone No. (702) 599-5920

Address: 13550 U.S. Hwy 93 Las Vegas, NV

I hereby acknowledge receipt of the above described materials
Jason Carter
Name (Print or Type)
Signature
Date Received: 10-7-10

81 Environmental Tech
13550 N Highway 93
Las Vegas, NV 89165

Ticket Type: INBOUND INVOICE

Ticket Number: 1980
Date: 10/07/2010
Time In: 3:32 pm
Time Out: 3:55 pm

Customer: 001011 - NGE, LLC c/o Northgate Environ Mgmt

Vehicle/Container: 81495P
Contract: Northgate Env. On Site Soils 3825 1t
Comment: 3825-10-11244

Gross Weight: 116,720 LB Manual In
Tare Weight: 53,340 LB Manual Out
Net Weight: 63380 LB
Net Tons: 31.69

BOL: 12070

Origin	Yards	Material	Billing Quantity
Not Applicable	0.00 YD	SW CONTAMINATED SOIL	31.69 TN

Driver: _____

Weighmaster: _____

IN - CARTERJ OUT - GUILFDE

Indemnification. Customer agrees, by signature above, to indemnify, hold harmless, and defend Republic Services, Inc., its subsidiaries, affiliates, employees, officers and directors from and against any and all liabilities, claims, penalties, forfeitures, suits and the costs and expenses incident thereto, including costs of defense, settlement, and reasonable attorney's fees, which may be incurred, as a result of death or injuries to any person, or damage to any property, contamination of or adverse effects on the environment, caused in whole or in part by the Customer, its employees, or subcontractors in disposing waste at this Facility. In the event Customer delivers Unacceptable Waste (as determined by Republic) Customer agrees to assume all expenses and obligations with the removal and/or resolution of any effects caused by the delivery of such Unacceptable Waste.

Indemnización. Cliente acuerda indemnizar, mantener inmune, y defender Republic Services, Inc., sus subsidiarios, compañías, divisiones, empleados, oficiales y directores contra de cualquiera y de todas responsabilidades, demandas, penas, pérdidas, juicios, pleitos y los costos incidente además, incluyendo costos de defensa, de acuerdo judicial, y de honorarios razonables del abogado, que pueden ser incurridos en, o como resultado de, la muerte o herida personal a cualquier persona, o daños a cualquier característica, propiedad, contaminación de la tierra o efectos ilícitos en esta Facilidad, causado entero o en parte por el cliente, sus empleados, o sus subcontratistas en botar basura en esta Facilidad. En el caso que el Cliente entrega, bota, basura (según lo determinado por Republic) en este Establecimiento basura inaceptable en los reglamentos de este Establecimiento, el Cliente se compromete asumir todos los costos y obligaciones con el retiro y/o la resolución de cualquier dano(s) causado por la entrega de tal basura inaceptable.



NON-HAZARDOUS WASTE MANIFEST

MANIFEST # 12070

GENERATOR INFORMATION

Generator Name: Tronox LLC

Address: P.O. Box 55

City: Henderson County: Clark

State: NV Zip: 89009

Site Location (if different): 560 W. Lake Mead
Henderson, NV 89015 (702) 592-7727

CUSTOMER/BILLING INFORMATION

Billing Name: NGE LLC c/o Northgate Environment Management

Address: 300 Frank Ogawa Plaza, Ste 510

City: Oakland County: Alameda

State: CA Zip: 94612

Table with 5 columns: Republic Services Approval #, Description of Waste, Volume/Weight, Expiration Date, Container Type. Row 1: 38251011244, Soil for disposal, 31.69, 12-31-2011, Tractor with Dump Trailer(s).

*Attach Additional Sheet if necessary

I hereby certify that the above-described materials are non-hazardous wastes as defined by 40 CFR 261 or any applicable state law. Further, that the above named materials are properly classified, described, packaged, marked and labeled, and are in proper condition for transportation according to the applicable regulations of the Department of Transportation.

Susan Crowley (Signature)
Generator/Authorized Agent Name Signature Date Shipped

TRANSPORTER INFORMATION

Transporter Name: Las Vegas Paving

DOT # 191949

Address: 4420 S. Decatur

Truck Number: 175

Las Vegas, NV 89103

Phone Number: (702) 353-4355

I certify no hazardous waste or other regulated substance was knowingly introduced to the waste while in my custody. The waste transported in this vehicle is the waste identified above, to the best of my knowledge.

Andrew Walker (Signature)
Name of Authorized Agent Signature Date Delivered 10-7-10

DISPOSAL SITE INFORMATION

Site Name: Apex Regional Landfill

Phone No. (702) 599-5920

Address: 13550 U.S. Hwy 93 Las Vegas, NV

I hereby acknowledge receipt of the above described materials
Debbie Switfale (Signature)
Name (Print or Type) Signature Date Received 10-7-10

81 Environmental Tech
13550 N Highway 93
Las Vegas, NV 89165

Ticket Type: INBOUND INVOICE

Ticket Number: 1981
Date: 10/07/2010
Time In: 3:36 pm
Time Out: 3:57 pm

Customer: 001011 - NGE, LLC c/o Northgate Environ Mgmt

Vehicle/Container: 64739P
Contract: Northgate Env. On Site Soils 3825 11
Comment: 3825-10-11244

Gross Weight: 130,220 LB Manual In
Tare Weight: 51,860 LB Manual Out
Net Weight: 78360 LB
Net Tons: 39.18

BOL: 12071

Origin	Yards	Material	Billing	Quantity
Not Applicable	0.00 YD	SW CONTAMINATED SOIL	39.18	TN

Driver: _____



Weighmaster: _____



IN - CARTERJ OUT - GUILFDE

Indemnification. Customer agrees, by signature above, to indemnify, hold harmless, and defend Republic Services, Inc., its subsidiaries, affiliates, employees, officers and directors from and against any and all liabilities, claims, penalties, forfeitures, suits and the costs and expenses incident thereto, including costs of defense, settlement, and reasonable attorney's fees, which may be incurred, as a result of death or injuries to any person, or damage to any property, contamination of or adverse effects on the environment, caused in whole or in part by the Customer, its employees, or subcontractors in disposing waste at this Facility. In the event Customer delivers Unacceptable Waste (as determined by Republic) Customer agrees to assume all expenses and obligations with the removal and/or resolution of any effects caused by the delivery of such Unacceptable Waste.

Indemnización. Cliente acuerda indemnizar, mantener inmune, y defender Republic Services, Inc., sus subsidiarios, compañías, divisiones, empleados, oficiales y directores contra de cualquiera y de todas responsabilidades, demandas, penas, pérdidas, juicios, pleitos y los costos incidente además, incluyendo costos de defensa, de acuerdo judicial, y de honorarios razonables del abogado, que pueden ser incurridos en, o como resultado de, la muerte o herida personal a cualquier persona, o daños a cualquier característica, propiedad, contaminación de la tierra o efectos ilícitos en esta Facilidad, causado entero o en parte por el cliente, sus empleados, o sus subcontratistas en botar basura en esta Facilidad. En el caso que el Cliente entrega, bota, basura (según lo determinado por Republic) en este Establecimiento basura inaceptable en los reglamentos de este Establecimiento, el Cliente se compromete asumir todos los costos y obligaciones con el retiro y/o la resolución de cualquier dano(s) causado por la entrega de tal basura inaceptable.



NON-HAZARDOUS WASTE MANIFEST

MANIFEST # 12071

GENERATOR INFORMATION

Generator Name: Tronox LLC

Address: P.O. Box 55

City: Henderson County: Clark

State: NV Zip: 89009

Site Location (if different): 560 W. Lake Mead

Henderson, NV 89015 (702) 592-7727

CUSTOMER/BILLING INFORMATION

Billing Name: NGE LLC c/o Northgate Environment Management

Address: 300 Frank Ogawa Plaza, Ste 510

City: Oakland County: Alameda

State: CA Zip: 94612

Republic Services Approval #	Description of Waste	Volume/Weight	Expiration Date	Container Type
38251011244	Soil for disposal		12-31-2011	Tractor with Dump Trailer(s)
	RZ- #	39.18		

*Attach Additional Sheet if necessary

I hereby certify that the above-described materials are non-hazardous wastes as defined by 40 CFR 261 or any applicable state law. Further, that the above named materials are properly classified, described, packaged, marked and labeled, and are in proper condition for transportation according to the applicable regulations of the Department of Transportation.

Susan Crowley

Tom Crowley

Generator/Authorized Agent Name

Signature

Date Shipped

TRANSPORTER INFORMATION

Transporter Name: Las Vegas Paving

DOT # 191949

Address: 4420 S. Decatur

Truck Number: 106

Las Vegas, NV 89103

Phone Number: (702) 353-4355

I certify no hazardous waste or other regulated substance was knowingly introduced to the waste while in my custody. The waste transported in this vehicle is the waste identified above, to the best of my knowledge.

Name of Authorized Agent

Signature

Date Delivered

10-7-10

DISPOSAL SITE INFORMATION

Site Name: Apex Regional Landfill

Phone No. (702) 599-5920

Address: 13550 U.S. Hwy 93 Las Vegas, NV

I hereby acknowledge receipt of the above described materials

Name (Print or Type)

Signature

Date Received

Debbie Saitore

Signature

10-7-10

81 Environmental Tech
13550 N Highway 93
Las Vegas, NV 89165

Ticket Type: INBOUND INVOICE

Ticket Number: 1983
Date: 10/07/2010
Time In: 3:53 pm
Time Out: 4:19 pm

Customer: 001011 - NGE, LLC c/o Northgate Environ Mgmt

Vehicle/Container: 66925P
Contract: Northgate Env. On Site Soils 3825 11
Comment: 3825-10-11244

Gross Weight: 132,420 LB Manual In
Tare Weight: 53,680 LB Manual Out
Net Weight: 78740 LB
Net Tons: 39.37

BOL: 12073

Origin	Yards	Material	Billing	Quantity
Not Applicable	0.00 YD	SW CONTAMINATED SOIL	39.37	TN

Driver: _____



Weighmaster: _____

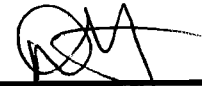

IN - CARTERJ OUT - GUILFDE

Indemnification. Customer agrees, by signature above, to indemnify, hold harmless, and defend Republic Services, Inc., its subsidiaries, affiliates, employees, officers and directors from and against any and all liabilities, claims, penalties, forfeitures, suits and the costs and expenses incident thereto, including costs of defense, settlement, and reasonable attorney's fees, which may be incurred, as a result of death or injuries to any person, or damage to any property, contamination of or adverse effects on the environment, caused in whole or in part by the Customer, its employees, or subcontractors in disposing waste at this Facility. In the event Customer delivers Unacceptable Waste (as determined by Republic) Customer agrees to assume all expenses and obligations with the removal and/or resolution of any effects caused by the delivery of such Unacceptable Waste.

Indemnización. Cliente acuerda indemnizar, mantener inmune, y defender Republic Services, Inc., sus subsidiarios, compañías, divisiones, empleados, oficiales y directores contra de cualquiera y de todas responsabilidades, demandas, penas, pérdidas, juicios, pleitos y los costos incidente además, incluyendo costos de defensa, de acuerdo judicial, y de honorarios razonables del abogado, que pueden ser incurridos en, o como resultado de, la muerte o herida personal a cualquier persona, o daños a cualquier característica, propiedad, contaminación de la tierra o efectos ilícitos en esta Facilidad, causado entero o en parte por el cliente, sus empleados, o sus subcontratistas en botar basura en esta Facilidad. En el caso que el Cliente entrega, bota, basura (según lo determinado por Republic) en este Establecimiento basura inaceptable en los reglamentos de este Establecimiento, el Cliente se compromete asumir todos los costos y obligaciones con el retiro y/o la resolución de cualquier dano(s) causado por la entrega de tal basura inaceptable.



NON-HAZARDOUS WASTE MANIFEST

MANIFEST # 12073

GENERATOR INFORMATION

Generator Name: Tronox LLC

Address: P.O. Box 55

City: Henderson County: Clark

State: NV Zip: 89009

Site Location (if different): 560 W. Lake Mead

Henderson, NV 89015 (702) 592-7727

CUSTOMER/BILLING INFORMATION

Billing Name: NGE LLC c/o Northgate Environment Management

Address: 300 Frank Ogawa Plaza, Ste 510

City: Oakland County: Alameda

State: CA Zip: 94612

Republic Services Approval #	Description of Waste	Volume/Weight	Expiration Date	Container Type
38251011244	Soil for disposal		12-31-2011	Tractor with Dump Trailer(s)
	RZ- #	39.37		

*Attach Additional Sheet if necessary

I hereby certify that the above-described materials are non-hazardous wastes as defined by 40 CFR 261 or any applicable state law. Further, that the above named materials are properly classified, described, packaged, marked and labeled, and are in proper condition for transportation according to the applicable regulations of the Department of Transportation.

Susan Crowley (Signature) Generator/Authorized Agent Name Signature Date Shipped

TRANSPORTER INFORMATION

Transporter Name: Las Vegas Paving

DOT # 191949

Address: 4420 S. Decatur

Truck Number: 55

Las Vegas, NV 89103

Phone Number: (702) 353-4355

I certify no hazardous waste or other regulated substance was knowingly introduced to the waste while in my custody. The waste transported in this vehicle is the waste identified above, to the best of my knowledge.

(Signature) Name of Authorized Agent Signature Date Delivered 10-7-10

DISPOSAL SITE INFORMATION

Site Name: Apex Regional Landfill

Phone No. (702) 599-5920

Address: 13550 U.S. Hwy 93 Las Vegas, NV

I hereby acknowledge receipt of the above described materials (Signature) Name (Print or Type) Signature Date Received 10-7-10

81 Environmental Tech
13550 N Highway 93
Las Vegas, NV 89165

Ticket Type: INBOUND INVOICE

Ticket Number: 1984
Date: 10/07/2010
Time In: 3:56 pm
Time Out: 4:21 pm

Customer: 001011 - NGE, LLC c/o Northgate Environ Mgmt

Vehicle/Container: 71893P
Contract: Northgate Env. On Site Soils 3825 11
Comment: 3825-10-11244

Gross Weight: 131,100 LB Manual In
Tare Weight: 53,100 LB Manual Out
Net Weight: 78000 LB
Net Tons: 39.00

BOL: 12074

Origin	Yards	Material	Billing	Quantity
Not Applicable	0.00 YD	SW CONTAMINATED SOIL	39.00	TN

Driver: _____

Weighmaster: _____

CARTERJ

Indemnification. Customer agrees, by signature above, to indemnify, hold harmless, and defend Republic Services, Inc., its subsidiaries, affiliates, employees, officers and directors from and against any and all liabilities, claims, penalties, forfeitures, suits and the costs and expenses incident thereto, including costs of defense, settlement, and reasonable attorney's fees, which may be incurred, as a result of death or injuries to any person, or damage to any property, contamination of or adverse effects on the environment, caused in whole or in part by the Customer, its employees, or subcontractors in disposing waste at this Facility. In the event Customer delivers Unacceptable Waste (as determined by Republic) Customer agrees to assume all expenses and obligations with the removal and/or resolution of any effects caused by the delivery of such Unacceptable Waste.

Indemnización. Cliente acuerda indemnizar, mantener inmune, y defender Republic Services, Inc., sus subsidiarios, compañías, divisiones, empleados, oficiales y directores contra de cualquiera y de todas responsabilidades, demandas, penas, pérdidas, juicios, pleitos y los costos incidente además, incluyendo costos de defensa, de acuerdo judicial, y de honorarios razonables del abogado, que pueden ser incurridos en, o como resultado de, la muerte o herida personal a cualquier persona, o daños a cualquier característica, propiedad, contaminación de la tierra o efectos ilícitos en esta Facilidad, causado entero o en parte por el cliente, sus empleados, o sus subcontratistas en botar basura en esta Facilidad. En el caso que el Cliente entrega, bota, basura (según lo determinado por Republic) en este Establecimiento basura inaceptable en los reglamentos de este Establecimiento, el Cliente se compromete asumir todos los costos y obligaciones con el retiro y/o la resolución de cualquier dano(s) causado por la entrega de tal basura inaceptable.



NON-HAZARDOUS WASTE MANIFEST

MANIFEST # 12074

GENERATOR INFORMATION

Generator Name: Tronox LLCAddress: P.O. Box 55City: Henderson County: ClarkState: NV Zip: 89009Site Location (if different): 560 W. Lake MeadHenderson, NV 89015 (702) 592-7727

CUSTOMER/BILLING INFORMATION

Billing Name: NGE LLC c/o Northgate Environment ManagementAddress: 300 Frank Ogawa Plaza, Ste 510City: Oakland County: AlamedaState: CA Zip: 94612

Republic Services Approval #	Description of Waste	Volume/Weight	Expiration Date	Container Type
38251011244	Soil for disposal		12-31-2011	Tractor with Dump Trailer(s)
	RZ- _____ # _____	39.00		

*Attach Additional Sheet if necessary

I hereby certify that the above-described materials are non-hazardous wastes as defined by 40 CFR 261 or any applicable state law. Further, that the above named materials are properly classified, described, packaged, marked and labeled, and are in proper condition for transportation according to the applicable regulations of the Department of Transportation.

Susan Crowley
Generator/Authorized Agent Name

Susan Crowley
Signature

Date Shipped

TRANSPORTER INFORMATION

Transporter Name: Las Vegas PavingDOT # 191949Address: 4420 S. DecaturTruck Number: 7Las Vegas, NV 89103Phone Number: (702) 353-4355

I certify no hazardous waste or other regulated substance was knowingly introduced to the waste while in my custody. The waste transported in this vehicle is the waste identified above, to the best of my knowledge.

Name of Authorized Agent

Signature

10-7-10
Date Delivered

DISPOSAL SITE INFORMATION

Site Name: Apex Regional LandfillPhone No. (702) 599-5920Address: 13550 U.S. Hwy 93 Las Vegas, NV

I hereby acknowledge receipt of the above described materials

Name (Print or Type)

Signature

10-7-10
Date Received

81 Environmental Tech
13550 N Highway 93
Las Vegas, NV 89165

Ticket Type: INBOUND INVOICE

Ticket Number: 1985
Date: 10/07/2010
Time In: 4:04 pm
Time Out: 4:25 pm

Customer: 001011 - NGE, LLC c/o Northgate Environ Mgmt

Vehicle/Container: 76953P
Contract: Northgate Env. On Site Soils 3825 11
Comment: 3825-10-11244

Gross Weight: 135,820 LB Manual In
Tare Weight: 55,380 LB Manual Out
Net Weight: 80440 LB
Net Tons: 40.22

BOL: 12072

Origin	Yards	Material	Billing	Quantity
Not Applicable	0.00 YD	SW CONTAMINATED SOIL	40.22	TN

Driver: Julio

Weighmaster: [Signature]

IN - CARTERJ OUT - GUILFDE

Indemnification. Customer agrees, by signature above, to indemnify, hold harmless, and defend Republic Services, Inc., its subsidiaries, affiliates, employees, officers and directors from and against any and all liabilities, claims, penalties, forfeitures, suits and the costs and expenses incident thereto, including costs of defense, settlement, and reasonable attorney's fees, which may be incurred, as a result of death or injuries to any person, or damage to any property, contamination of or adverse effects on the environment, caused in whole or in part by the Customer, its employees, or subcontractors in disposing waste at this Facility. In the event Customer delivers Unacceptable Waste (as determined by Republic) Customer agrees to assume all expenses and obligations with the removal and/or resolution of any effects caused by the delivery of such Unacceptable Waste.

Indemnización. Cliente acuerda indemnizar, mantener inmune, y defender Republic Services, Inc., sus subsidiarios, compañías, divisiones, empleados, oficiales y directores contra de cualquiera y de todas responsabilidades, demandas, penas, pérdidas, juicios, pleitos y los costos incidente además, incluyendo costos de defensa, de acuerdo judicial, y de honorarios razonables del abogado, que pueden ser incurridos en, o como resultado de, la muerte o herida personal a cualquier persona, o daños a cualquier característica, propiedad, contaminación de la tierra o efectos ilícitos en esta Facilidad. En el caso que el Cliente entrega, bota, basura (según lo determinado por Republic) en este Establecimiento basura inaceptable en los reglamentos de este Establecimiento, el Cliente se compromete asumir todos los costos y obligaciones con el retiro y/o la resolución de cualquier dano(s) causado por la entrega de tal basura inaceptable.



NON-HAZARDOUS WASTE MANIFEST

MANIFEST # 12072

GENERATOR INFORMATION

Generator Name: Tronox LLC

Address: P.O. Box 55

City: Henderson County: Clark

State: NV Zip: 89009

Site Location (if different): 560 W. Lake Mead
Henderson, NV 89015 (702) 592-7727

CUSTOMER/BILLING INFORMATION

Billing Name: NGE LLC c/o Northgate Environment Management

Address: 300 Frank Ogawa Plaza, Ste 510

City: Oakland County: Alameda

State: CA Zip: 94612

Table with 5 columns: Republic Services Approval #, Description of Waste, Volume/Weight, Expiration Date, Container Type. Row 1: 38251011244, Soil for disposal, 40.22, 12-31-2011, Tractor with Dump Trailer(s). Row 2: RZ- #

*Attach Additional Sheet if necessary

I hereby certify that the above-described materials are non-hazardous wastes as defined by 40 CFR 261 or any applicable state law. Further, that the above named materials are properly classified, described, packaged, marked and labeled, and are in proper condition for transportation according to the applicable regulations of the Department of Transportation.

Susan Crowley (Signature) Date Shipped
Generator/Authorized Agent Name Signature Date Shipped

TRANSPORTER INFORMATION

Transporter Name: Las Vegas Paving

DOT # 191949

Address: 4420 S. Decatur

Truck Number: 21

Las Vegas, NV 89103

Phone Number: (702) 353-4355

I certify no hazardous waste or other regulated substance was knowingly introduced to the waste while in my custody. The waste transported in this vehicle is the waste identified above, to the best of my knowledge.

Name of Authorized Agent Signature Date Delivered
Julio 10-7-10

DISPOSAL SITE INFORMATION

Site Name: Apex Regional Landfill

Phone No. (702) 599-5920

Address: 13550 U.S. Hwy 93 Las Vegas, NV

I hereby acknowledge receipt of the above described materials
Debbie Sutto (Signature) Date Received 10-7-10
Name (Print or Type) Signature Date Received

81 Environmental Tech
13550 N Highway 93
Las Vegas, NV 89165

Ticket Type: INBOUND INVOICE

Ticket Number: 1986
Date: 10/07/2010
Time In: 4:00 pm
Time Out: 4:27 pm

Customer: 001011 - NGE, LLC c/o Northgate Environ Mgmt

Vehicle/Container: 68628P
Contract: Northgate Env. On Site Soils 3825 1t
Comment: 3825-10-11244

Gross Weight: 133,780 LB Manual In
Tare Weight: 54,460 LB Manual Out
Net Weight: 79320 LB
Net Tons: 39.66

BOL: 12075

Origin	Yards	Material	Billing	Quantity
Not Applicable	0.00 YD	SW CONTAMINATED SOIL	39.66	TN

Driver: _____

J J 7

Weighmaster: _____



IN - CARTERJ OUT - GUILFDE

Indemnification. Customer agrees, by signature above, to indemnify, hold harmless, and defend Republic Services, Inc., its subsidiaries, affiliates, employees, officers and directors from and against any and all liabilities, claims, penalties, forfeitures, suits and the costs and expenses incident thereto, including costs of defense, settlement, and reasonable attorney's fees, which may be incurred, as a result of death or injuries to any person, or damage to any property, contamination of or adverse effects on the environment, caused in whole or in part by the Customer, its employees, or subcontractors in disposing waste at this Facility. In the event Customer delivers Unacceptable Waste (as determined by Republic) Customer agrees to assume all expenses and obligations with the removal and/or resolution of any effects caused by the delivery of such Unacceptable Waste.

Indemnización. Cliente acuerda indemnizar, mantener inmune, y defender Republic Services, Inc., sus subsidiarios, compañías, divisiones, empleados, oficiales y directores contra de cualquiera y de todas responsabilidades, demandas, penas, pérdidas, juicios, pleitos y los costos incidente además, incluyendo costos de defensa, de acuerdo judicial, y de honorarios razonables del abogado, que pueden ser incurridos en, o como resultado de, la muerte o herida personal a cualquier persona, o daños a cualquier característica, propiedad, contaminación de la tierra o efectos ilícitos en esta Facilidad, causado entero o en parte por el cliente, sus empleados, o sus subcontratistas en botar basura en esta Facilidad. En el caso que el Cliente entrega, bota, basura (según lo determinado por Republic) en este Establecimiento basura inaceptable en los reglamentos de este Establecimiento, el Cliente se compromete asumir todos los costos y obligaciones con el retiro y/o la resolución de cualquier dano(s) causado por la entrega de tal basura inaceptable.



NON-HAZARDOUS WASTE MANIFEST

MANIFEST # 12075

GENERATOR INFORMATION

Generator Name: Tronox LLC
Address: P.O. Box 55
City: Henderson County: Clark
State: NV Zip: 89009
Site Location (if different): 560 W. Lake Mead
Henderson, NV 89015 (702) 592-7727

CUSTOMER/BILLING INFORMATION

Billing Name: NGE LLC c/o Northgate Environment Management
Address: 300 Frank Ogawa Plaza, Ste 510
City: Oakland County: Alameda
State: CA Zip: 94612

Table with 5 columns: Republic Services Approval #, Description of Waste, Volume/Weight, Expiration Date, Container Type. Row 1: 38251011244, Soil for disposal, 39.66, 12-31-2011, Tractor with Dump Trailer(s).

*Attach Additional Sheet if necessary

I hereby certify that the above-described materials are non-hazardous wastes as defined by 40 CFR 261 or any applicable state law. Further, that the above named materials are properly classified, described, packaged, marked and labeled, and are in proper condition for transportation according to the applicable regulations of the Department of Transportation.

Susan Crowley (Signature)
Generator/Authorized Agent Name Signature Date Shipped

TRANSPORTER INFORMATION

Transporter Name: Las Vegas Paving DOT # 191949
Address: 4420 S. Decatur Truck Number: RH301
Las Vegas, NV 89103 Phone Number: (702) 353-4355

I certify no hazardous waste or other regulated substance was knowingly introduced to the waste while in my custody. The waste transported in this vehicle is the waste identified above, to the best of my knowledge.

Name of Authorized Agent Signature Date Delivered (Signature) 10-7-10

DISPOSAL SITE INFORMATION

Site Name: Apex Regional Landfill Phone No. (702) 599-5920
Address: 13550 U.S. Hwy 93 Las Vegas, NV

I hereby acknowledge receipt of the above described materials
Debbie Gault (Signature) Date Received 10-7-10

81 Environmental Tech
13550 N Highway 93
Las Vegas, NV 89165

Ticket Type: INBOUND INVOICE

Ticket Number: 1987
Date: 10/07/2010
Time In: 4:21 pm
Time Out: 4:50 pm

Customer: 001011 - NGE, LLC c/o Northgate Environ Mgmt

Vehicle/Container: 85887P
Contract: Northgate Env. On Site Soils 3825 11
Comment: 3825-10-11244

Gross Weight: 130,580 LB Manual In
Tare Weight: 50,780 LB Manual Out
Net Weight: 79800 LB
Net Tons: 39.90

BOL: 12076

Origin	Yards	Material	Billing	Quantity
Not Applicable	0.00 YD	SW CONTAMINATED SOIL	39.90	TN

Driver: Miguel

Weighmaster: CARTERJ

Indemnification. Customer agrees, by signature above, to indemnify, hold harmless, and defend Republic Services, Inc., its subsidiaries, affiliates, employees, officers and directors from and against any and all liabilities, claims, penalties, forfeitures, suits and the costs and expenses incident thereto, including costs of defense, settlement, and reasonable attorney's fees, which may be incurred, as a result of death or injuries to any person, or damage to any property, contamination of or adverse effects on the environment, caused in whole or in part by the Customer, its employees, or subcontractors in disposing waste at this Facility. In the event Customer delivers Unacceptable Waste (as determined by Republic) Customer agrees to assume all expenses and obligations with the removal and/or resolution of any effects caused by the delivery of such Unacceptable Waste.

Indemnización. Cliente acuerda indemnizar, mantener inmune, y defender Republic Services, Inc., sus subsidiarios, compañías, divisiones, empleados, oficiales y directores contra de cualquiera y de todas responsabilidades, demandas, penas, pérdidas, juicios, pleitos y los costos incidente además, incluyendo costos de defensa, de acuerdo judicial, y de honorarios razonables del abogado, que pueden ser incurridos en, o como resultado de, la muerte o herida personal a cualquier persona, o daños a cualquier característica, propiedad, contaminación de la tierra o efectos ilícitos en esta Facilidad, causado entero o en parte por el cliente, sus empleados, o sus subcontratistas en botar basura en esta Facilidad. En el caso que el Cliente entrega, bota, basura (según lo determinado por Republic) en este Establecimiento basura inaceptable en los reglamentos de este Establecimiento, el Cliente se compromete asumir todos los costos y obligaciones con el retiro y/o la resolución de cualquier dano(s) causado por la entrega de tal basura inaceptable.



NON-HAZARDOUS WASTE MANIFEST

MANIFEST # 12076

GENERATOR INFORMATION

Generator Name: Tronox LLC
Address: P.O. Box 55
City: Henderson County: Clark
State: NV Zip: 89009
Site Location (if different): 560 W. Lake Mead
Henderson, NV 89015 (702) 592-7727

CUSTOMER/BILLING INFORMATION

Billing Name: NGE LLC c/o Northgate Environment Management
Address: 300 Frank Ogawa Plaza, Ste 510
City: Oakland County: Alameda
State: CA Zip: 94612

Table with 5 columns: Republic Services Approval #, Description of Waste, Volume/Weight, Expiration Date, Container Type. Row 1: 38251011244, Soil for disposal, 39.90 TN, 12-31-2011, Tractor with Dump Trailer(s). Row 2: RZ- #

*Attach Additional Sheet if necessary

I hereby certify that the above-described materials are non-hazardous wastes as defined by 40 CFR 261 or any applicable state law. Further, that the above named materials are properly classified, described, packaged, marked and labeled, and are in proper condition for transportation according to the applicable regulations of the Department of Transportation.

Susan Crowley (Signature)
Generator/Authorized Agent Name Signature Date Shipped

TRANSPORTER INFORMATION

Transporter Name: Las Vegas Paving DOT # 191949
Address: 4420 S. Decatur Truck Number: P01
Las Vegas, NV 89103 Phone Number: (702) 353-4355

I certify no hazardous waste or other regulated substance was knowingly introduced to the waste while in my custody. The waste transported in this vehicle is the waste identified above, to the best of my knowledge.

Miguel Roman (Signature)
Name of Authorized Agent Signature Date Delivered 10-9-10

DISPOSAL SITE INFORMATION

Site Name: Apex Regional Landfill Phone No. (702) 599-5920
Address: 13550 U.S. Hwy 93 Las Vegas, NV

I hereby acknowledge receipt of the above described materials.
JASON CARTER (Signature)
Name (Print or Type) Signature Date Received 10/7/10

81 Environmental Tech
13550 N Highway 93
Las Vegas, NV 89165

Ticket Type: INBOUND INVOICE

Ticket Number: 1988
Date: 10/07/2010
Time In: 4:37 pm
Time Out: 5:01 pm

Customer: 001011 - NGE, LLC c/o Northgate Environ Mgmt

Vehicle/Container: Z009877
Contract: Northgate Env. On Site Soils 3825 11
Comment: 3825-10-11244

Gross Weight: 125,720 LB Manual In
Tare Weight: 49,040 LB Manual Out
Net Weight: 76680 LB
Net Tons: 38.34

BOL: 12077

Origin	Yards	Material	Billing	Quantity
Not Applicable	0.00 YD	SW CONTAMINATED SOIL	38.34	TN

Driver: _____

Weighmaster: _____

CARTERJ

Indemnification. Customer agrees, by signature above, to indemnify, hold harmless, and defend Republic Services, Inc., its subsidiaries, affiliates, employees, officers and directors from and against any and all liabilities, claims, penalties, forfeitures, suits and the costs and expenses incident thereto, including costs of defense, settlement, and reasonable attorney's fees, which may be incurred, as a result of death or injuries to any person, or damage to any property, contamination of or adverse effects on the environment, caused in whole or in part by the Customer, its employees, or subcontractors in disposing waste at this Facility. In the event Customer delivers Unacceptable Waste (as determined by Republic) Customer agrees to assume all expenses and obligations with the removal and/or resolution of any effects caused by the delivery of such Unacceptable Waste.

Indemnización. Cliente acuerda indemnizar, mantener inmune, y defender Republic Services, Inc., sus subsidiarios, compañías, divisiones, empleados, oficiales y directores contra de cualquiera y de todas responsabilidades, demandas, penas, pérdidas, juicios, pleitos y los costos incidente además, incluyendo costos de defensa, de acuerdo judicial, y de honorarios razonables del abogado, que pueden ser incurridos en, o como resultado de, la muerte o herida personal a cualquier persona, o daños a cualquier característica, propiedad, contaminación de la tierra o efectos ilícitos en esta Facilidad, causado entero o en parte por el cliente, sus empleados, o sus subcontratistas en botar basura en esta Facilidad. En el caso que el Cliente entrega, bota, basura (según lo determinado por Republic) en este Establecimiento basura inaceptable en los reglamentos de este Establecimiento, el Cliente se compromete asumir todos los costos y obligaciones con el retiro y/o la resolución de cualquier dano(s) causado por la entrega de tal basura inaceptable.



NON-HAZARDOUS WASTE MANIFEST

MANIFEST # 12077

GENERATOR INFORMATION

Generator Name: Tronox LLC
Address: P.O. Box 55
City: Henderson County: Clark
State: NV Zip: 89009
Site Location (if different): 560 W. Lake Mead
Henderson, NV 89015 (702) 592-7727

CUSTOMER/BILLING INFORMATION

Billing Name: NGE LLC c/o Northgate Environment Management
Address: 300 Frank Ogawa Plaza, Ste 510
City: Oakland County: Alameda
State: CA Zip: 94612

Table with 5 columns: Republic Services Approval #, Description of Waste, Volume/Weight, Expiration Date, Container Type. Row 1: 38251011244, Soil for disposal, 38.34 TN, 12-31-2011, Tractor with Dump Trailer(s).

*Attach Additional Sheet if necessary

I hereby certify that the above-described materials are non-hazardous wastes as defined by 40 CFR 261 or any applicable state law. Further, that the above named materials are properly classified, described, packaged, marked and labeled, and are in proper condition for transportation according to the applicable regulations of the Department of Transportation.

Susan Crowley
Generator/Authorized Agent Name Signature Date Shipped

TRANSPORTER INFORMATION

Transporter Name: Las Vegas Paving DOT # 191949
Address: 4420 S. Decatur Truck Number: 2010
Las Vegas, NV 89103 Phone Number: (702) 353-4355

I certify no hazardous waste or other regulated substance was knowingly introduced to the waste while in my custody. The waste transported in this vehicle is the waste identified above, to the best of my knowledge.

Name of Authorized Agent Signature Date Delivered 10.7.10

DISPOSAL SITE INFORMATION

Site Name: Apex Regional Landfill Phone No. (702) 599-5920
Address: 13550 U.S. Hwy 93 Las Vegas, NV

I hereby acknowledge receipt of the above described materials

JASON CARTER
Name (Print or Type) Signature Date Received 10/7/10

81 Environmental Tech
13550 N Highway 93
Las Vegas, NV 89165

Ticket Type: INBOUND INVOICE

Ticket Number: 1989
Date: 10/07/2010
Time In: 4:42 pm
Time Out: 5:06 pm

Customer: 001011 - NGE, LLC c/o Northgate Environ Mgmt

Vehicle/Container: 84893P
Contract: Northgate Env. On Site Soils 3825 11
Comment: 3825-10-11244

Gross Weight: 134,340 LB Manual In
Tare Weight: 54,260 LB Manual Out
Net Weight: 80080 LB
Net Tons: 40.04

BOL: 12063

Origin	Yards	Material	Billing	Quantity
Not Applicable	0.00 YD	SW CONTAMINATED SOIL	40.04	TN

Driver: _____



Weighmaster: _____



CARTERJ

Indemnification. Customer agrees, by signature above, to indemnify, hold harmless, and defend Republic Services, Inc., its subsidiaries, affiliates, employees, officers and directors from and against any and all liabilities, claims, penalties, forfeitures, suits and the costs and expenses incident thereto, including costs of defense, settlement, and reasonable attorney's fees, which may be incurred, as a result of death or injuries to any person, or damage to any property, contamination of or adverse effects on the environment, caused in whole or in part by the Customer, its employees, or subcontractors in disposing waste at this Facility. In the event Customer delivers Unacceptable Waste (as determined by Republic) Customer agrees to assume all expenses and obligations with the removal and/or resolution of any effects caused by the delivery of such Unacceptable Waste.

Indemnización. Cliente acuerda indemnizar, mantener inmune, y defender Republic Services, Inc., sus subsidiarios, compañías, divisiones, empleados, oficiales y directores contra de cualquiera y de todas responsabilidades, demandas, penas, pérdidas, juicios, pleitos y los costos incidente además, incluyendo costos de defensa, de acuerdo judicial, y de honorarios razonables del abogado, que pueden ser incurridos en, o como resultado de, la muerte o herida personal a cualquier persona, o daños a cualquier característica, propiedad, contaminación de la tierra o efectos ilícitos en esta Facilidad, causado entero o en parte por el cliente, sus empleados, o sus subcontratistas en botar basura en esta Facilidad. En el caso que el Cliente entrega, bota, basura (según lo determinado por Republic) en este Establecimiento basura inaceptable en los reglamentos de este Establecimiento, el Cliente se compromete asumir todos los costos y obligaciones con el retiro y/o la resolución de cualquier dano(s) causado por la entrega de tal basura inaceptable.



NON-HAZARDOUS WASTE MANIFEST

MANIFEST # 12063

GENERATOR INFORMATION

Generator Name: Tronox LLC

Address: P.O. Box 55

City: Henderson County: Clark

State: NV Zip: 89009

Site Location (if different): 560 W. Lake Mead

Henderson, NV 89015 (702) 592-7727

CUSTOMER/BILLING INFORMATION

Billing Name: NGE LLC c/o Northgate Environment Management

Address: 300 Frank Ogawa Plaza, Ste 510

City: Oakland County: Alameda

State: CA Zip: 94612

Republic Services Approval #	Description of Waste	Volume/Weight	Expiration Date	Container Type
38251011244	Soil for disposal	4004 TN	12-31-2011	Tractor with Dump Trailer(s)
	RZ- #			

*Attach Additional Sheet if necessary

I hereby certify that the above-described materials are non-hazardous wastes as defined by 40 CFR 261 or any applicable state law. Further, that the above named materials are properly classified, described, packaged, marked and labeled, and are in proper condition for transportation according to the applicable regulations of the Department of Transportation.

Susan Crowley (Signature) Generator/Authorized Agent Name Signature Date Shipped

TRANSPORTER INFORMATION

Transporter Name: Las Vegas Paving

DOT # 191949

Address: 4420 S. Decatur

Truck Number: 303

Las Vegas, NV 89103

Phone Number: (702) 353-4355

I certify no hazardous waste or other regulated substance was knowingly introduced to the waste while in my custody. The waste transported in this vehicle is the waste identified above, to the best of my knowledge.

(Signature) Name of Authorized Agent Signature Date Delivered 10-7-10

DISPOSAL SITE INFORMATION

Site Name: Apex Regional Landfill

Phone No. (702) 599-5920

Address: 13550 U.S. Hwy 93 Las Vegas, NV

I hereby acknowledge receipt of the above described materials

JASON CARTER (Signature) Name (Print or Type) Signature Date Received 10/7/10

81 Environmental Tech
13550 N Highway 93
Las Vegas, NV 89165

Ticket Type: INBOUND INVOICE

Ticket Number: 1990
Date: 10/07/2010
Time In: 4:48 pm
Time Out: 5:15 pm

Customer: 001011 - NGE, LLC c/o Northgate Environ Mgmt

Vehicle/Container: 44164A
Contract: Northgate Env. On Site Soils 3825 11
Comment: 3825-10-11244

Gross Weight: 135,160 LB Manual In
Tare Weight: 55,300 LB Manual Out
Net Weight: 79860 LB
Net Tons: 39.93

BOL: 12078

Origin	Yards	Material	Billing	Quantity
Not Applicable	0.00 YD	SW CONTAMINATED SOIL	39.93 TN	

Driver:

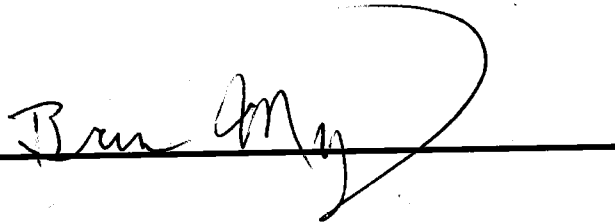

Weighmaster:

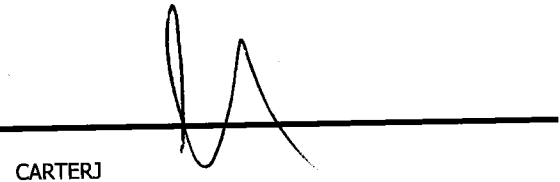

CARTERJ

Indemnification. Customer agrees, by signature above, to indemnify, hold harmless, and defend Republic Services, Inc., its subsidiaries, affiliates, employees, officers and directors from and against any and all liabilities, claims, penalties, forfeitures, suits and the costs and expenses incident thereto, including costs of defense, settlement, and reasonable attorney's fees, which may be incurred, as a result of death or injuries to any person, or damage to any property, contamination of or adverse effects on the environment, caused in whole or in part by the Customer, its employees, or subcontractors in disposing waste at this Facility. In the event Customer delivers Unacceptable Waste (as determined by Republic) Customer agrees to assume all expenses and obligations with the removal and/or resolution of any effects caused by the delivery of such Unacceptable Waste.

Indemnización. Cliente acuerda indemnizar, mantener inmune, y defender Republic Services, Inc., sus subsidiarios, compañías, divisiones, empleados, oficiales y directores contra de cualquiera y de todas responsabilidades, demandas, penas, pérdidas, juicios, pleitos y los costos incidente además, incluyendo costos de defensa, de acuerdo judicial, y de honorarios razonables del abogado, que pueden ser incurridos en, o como resultado de, la muerte o herida personal a cualquier persona, o daños a cualquier característica, propiedad, contaminación de la tierra o efectos ilícitos en esta Facilidad, causado entero o en parte por el cliente, sus empleados, o sus subcontratistas en botar basura en esta Facilidad. En el caso que el Cliente entrega, bota, basura (según lo determinado por Republic) en este Establecimiento basura inaceptable en los reglamentos de este Establecimiento, el Cliente se compromete asumir todos los costos y obligaciones con el retiro y/o la resolución de cualquier dano(s) causado por la entrega de tal basura inaceptable.



NON-HAZARDOUS WASTE MANIFEST

MANIFEST # 12078

GENERATOR INFORMATION

Generator Name: Tronox LLC

Address: P.O. Box 55

City: Henderson County: Clark

State: NV Zip: 89009

Site Location (if different): 560 W. Lake Mead
Henderson, NV 89015 (702) 592-7727

CUSTOMER/BILLING INFORMATION

Billing Name: NGE LLC c/o Northgate Environment Management

Address: 300 Frank Ogawa Plaza, Ste 510

City: Oakland County: Alameda

State: CA Zip: 94612

Table with 5 columns: Republic Services Approval #, Description of Waste, Volume/Weight, Expiration Date, Container Type. Row 1: 38251011244, Soil for disposal, 39.93 TN, 12-31-2011, Tractor with Dump Trailer(s).

*Attach Additional Sheet if necessary

I hereby certify that the above-described materials are non-hazardous wastes as defined by 40 CFR 261 or any applicable state law. Further, that the above named materials are properly classified, described, packaged, marked and labeled, and are in proper condition for transportation according to the applicable regulations of the Department of Transportation.

Susan Crowley (Signature)
Generator/Authorized Agent Name Signature Date Shipped

TRANSPORTER INFORMATION

Transporter Name: Las Vegas Paving

DOT # 191949

Address: 4420 S. Decatur

Truck Number: K-006

Las Vegas, NV 89103

Phone Number: (702) 353-4355

I certify no hazardous waste or other regulated substance was knowingly introduced to the waste while in my custody. The waste transported in this vehicle is the waste identified above, to the best of my knowledge.

Drian Mulvey (Signature)
Name of Authorized Agent Signature Date Delivered 10.7.10

DISPOSAL SITE INFORMATION

Site Name: Apex Regional Landfill

Phone No. (702) 599-5920

Address: 13550 U.S. Hwy 93 Las Vegas, NV

I hereby acknowledge receipt of the above described materials

JASON CARTER (Signature)
Name (Print or Type) Signature Date Received 10/7/10

81 Environmental Tech
13550 N Highway 93
Las Vegas, NV 89165

Ticket Type: INBOUND INVOICE

Ticket Number: 1991
Date: 10/07/2010
Time In: 4:52 pm
Time Out: 5:22 pm

Customer: 001011 - NGE, LLC c/o Northgate Environ Mgmt

Vehicle/Container: 85914P
Contract: Northgate Env. On Site Soils 3825 11
Comment: 3825-10-11244

Gross Weight: 135,620 LB Manual In
Tare Weight: 53,800 LB Manual Out
Net Weight: 81,820 LB
Net Tons: 40.91

BOL: 12079

Origin	Yards	Material	Billing	Quantity
Not Applicable	0.00 YD	SW CONTAMINATED SOIL	40.91	TN

Driver: _____



Weighmaster: _____

CARTERJ



Indemnification. Customer agrees, by signature above, to indemnify, hold harmless, and defend Republic Services, Inc., its subsidiaries, affiliates, employees, officers and directors from and against any and all liabilities, claims, penalties, forfeitures, suits and the costs and expenses incident thereto, including costs of defense, settlement, and reasonable attorney's fees, which may be incurred, as a result of death or injuries to any person, or damage to any property, contamination of or adverse effects on the environment, caused in whole or in part by the Customer, its employees, or subcontractors in disposing waste at this Facility. In the event Customer delivers Unacceptable Waste (as determined by Republic) Customer agrees to assume all expenses and obligations with the removal and/or resolution of any effects caused by the delivery of such Unacceptable Waste.

Indemnización. Cliente acuerda indemnizar, mantener inmune, y defender Republic Services, Inc., sus subsidiarios, compañías, divisiones, empleados, oficiales y directores contra de cualquiera y de todas responsabilidades, demandas, penas, pérdidas, juicios, pleitos y los costos incidente además, incluyendo costos de defensa, de acuerdo judicial, y de honorarios razonables del abogado, que pueden ser incurridos en, o como resultado de, la muerte o herida personal a cualquier persona, o daños a cualquier característica, propiedad, contaminación de la tierra o efectos ilícitos en esta Facilidad, causado entero o en parte por el cliente, sus empleados, o sus subcontratistas en botar basura en esta Facilidad. En el caso que el Cliente entrega, bota, basura (según lo determinado por Republic) en este Establecimiento basura inaceptable en los reglamentos de este Establecimiento, el Cliente se compromete asumir todos los costos y obligaciones con el retiro y/o la resolución de cualquier dano(s) causado por la entrega de tal basura inaceptable.



NON-HAZARDOUS WASTE MANIFEST

MANIFEST # 12079

GENERATOR INFORMATION

Generator Name: Tronox LLC

Address: P.O. Box 55

City: Henderson County: Clark

State: NV Zip: 89009

Site Location (if different): 560 W. Lake Mead
Henderson, NV 89015 (702) 592-7727

CUSTOMER/BILLING INFORMATION

Billing Name: NGE LLC c/o Northgate Environment Management

Address: 300 Frank Ogawa Plaza, Ste 510

City: Oakland County: Alameda

State: CA Zip: 94612

Table with 5 columns: Republic Services Approval #, Description of Waste, Volume/Weight, Expiration Date, Container Type. Row 1: 38251011244, Soil for disposal, 40.91 TN, 12-31-2011, Tractor with Dump Trailer(s). Row 2: RZ- #

*Attach Additional Sheet if necessary

I hereby certify that the above-described materials are non-hazardous wastes as defined by 40 CFR 261 or any applicable state law. Further, that the above named materials are properly classified, described, packaged, marked and labeled, and are in proper condition for transportation according to the applicable regulations of the Department of Transportation.

Susan Crowley (Signature)
Generator/Authorized Agent Name Signature Date Shipped

TRANSPORTER INFORMATION

Transporter Name: Las Vegas Paving

DOT # 191949

Address: 4420 S. Decatur

Truck Number: 07

Las Vegas, NV 89103

Phone Number: (702) 353-4355

I certify no hazardous waste or other regulated substance was knowingly introduced to the waste while in my custody. The waste transported in this vehicle is the waste identified above, to the best of my knowledge.

DAVID DELCID (Signature)
Name of Authorized Agent Signature Date Delivered 10.7.10

DISPOSAL SITE INFORMATION

Site Name: Apex Regional Landfill

Phone No. (702) 599-5920

Address: 13550 U.S. Hwy 93 Las Vegas, NV

I hereby acknowledge receipt of the above described materials
JASON CARTER (Signature)
Name (Print or Type) Signature Date Received 10/7/10

81 Environmental Tech
13550 N Highway 93
Las Vegas, NV 89165

Ticket Type: INBOUND INVOICE

Ticket Number: 1992
Date: 10/07/2010
Time In: 4:57 pm
Time Out: 5:24 pm

Customer: 001011 - NGE, LLC c/o Northgate Environ Mgmt

Vehicle/Container: 82515P
Contract: Northgate Env. On Site Soils 3825 11
Comment: 3825-10-11244

Gross Weight: 136,640 LB Manual In
Tare Weight: 52,540 LB Manual Out
Net Weight: 84100 LB
Net Tons: 42.05

BOL: 12080

Origin	Yards	Material	Billing	Quantity
Not Applicable	0.00 YD	SW CONTAMINATED SOIL	42.05	TN

Driver:

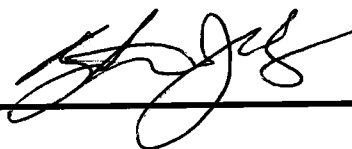

Weighmaster:

CARTERJ

Indemnification. Customer agrees, by signature above, to indemnify, hold harmless, and defend Republic Services, Inc., its subsidiaries, affiliates, employees, officers and directors from and against any and all liabilities, claims, penalties, forfeitures, suits and the costs and expenses incident thereto, including costs of defense, settlement, and reasonable attorney's fees, which may be incurred, as a result of death or injuries to any person, or damage to any property, contamination of or adverse effects on the environment, caused in whole or in part by the Customer, its employees, or subcontractors in disposing waste at this Facility. In the event Customer delivers Unacceptable Waste (as determined by Republic) Customer agrees to assume all expenses and obligations with the removal and/or resolution of any effects caused by the delivery of such Unacceptable Waste.

Indemnización. Cliente acuerda indemnizar, mantener inmune, y defender Republic Services, Inc., sus subsidiarios, compañías, divisiones, empleados, oficiales y directores contra de cualquiera y de todas responsabilidades, demandas, penas, pérdidas, juicios, pleitos y los costos incidente además, incluyendo costos de defensa, de acuerdo judicial, y de honorarios razonables del abogado, que pueden ser incurridos en, o como resultado de, la muerte o herida personal a cualquier persona, o daños a cualquier característica, propiedad, contaminación de la tierra o efectos ilícitos en esta Facilidad, causado entero o en parte por el cliente, sus empleados, o sus subcontratistas en botar basura en esta Facilidad. En el caso que el Cliente entrega, bota, basura (según lo determinado por Republic) en este Establecimiento basura inaceptable en los reglamentos de este Establecimiento, el Cliente se compromete asumir todos los costos y obligaciones con el retiro y/o la resolución de cualquier dano(s) causado por la entrega de tal basura inaceptable.



NON-HAZARDOUS WASTE MANIFEST

MANIFEST # 12080

GENERATOR INFORMATION

Generator Name: Tronox LLC

Address: P.O. Box 55

City: Henderson County: Clark

State: NV Zip: 89009

Site Location (if different): 560 W. Lake Mead

Henderson, NV 89015 (702) 592-7727

CUSTOMER/BILLING INFORMATION

Billing Name: NGE LLC c/o Northgate Environment Management

Address: 300 Frank Ogawa Plaza, Ste 510

City: Oakland County: Alameda

State: CA Zip: 94612

Republic Services Approval #	Description of Waste	Volume/Weight	Expiration Date	Container Type
38251011244	Soil for disposal	42.05 TN	12-31-2011	Tractor with Dump Trailer(s)
	RZ- _____ # _____			

*Attach Additional Sheet if necessary

I hereby certify that the above-described materials are non-hazardous wastes as defined by 40 CFR 261 or any applicable state law. Further, that the above named materials are properly classified, described, packaged, marked and labeled, and are in proper condition for transportation according to the applicable regulations of the Department of Transportation.

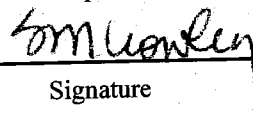
Susan Crowley  _____
 Generator/Authorized Agent Name Signature Date Shipped

TRANSPORTER INFORMATION

Transporter Name: Las Vegas Paving

DOT # 191949

Address: 4420 S. Decatur

Truck Number: 144

Las Vegas, NV 89103

Phone Number: (702) 353-4355

I certify no hazardous waste or other regulated substance was knowingly introduced to the waste while in my custody. The waste transported in this vehicle is the waste identified above, to the best of my knowledge.

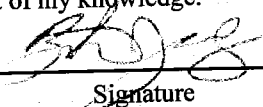
_____  _____
 Name of Authorized Agent Signature Date Delivered 10-7-10

DISPOSAL SITE INFORMATION

Site Name: Apex Regional Landfill

Phone No. (702) 599-5920

Address: 13550 U.S. Hwy 93 Las Vegas, NV

I hereby acknowledge receipt of the above described materials

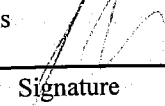
JASON CARTER  _____
 Name (Print or Type) Signature Date Received 10/7/10

81 Environmental Tech
13550 N Highway 93
Las Vegas, NV 89165

Ticket Type: INBOUND INVOICE

Ticket Number: 1993
Date: 10/07/2010
Time In: 5:23 pm
Time Out: 5:52 pm

Customer: 001011 - NGE, LLC c/o Northgate Environ Mgmt

Vehicle/Container: 29573A
Contract: Northgate Env. On Site Soils 3825 11
Comment: 3825-10-11244

Gross Weight: 139,200 LB Manual In
Tare Weight: 53,760 LB Manual Out
Net Weight: 85440 LB
Net Tons: 42.72

BOL: 12081

Origin	Yards	Material	Billing	Quantity
Not Applicable	0.00 YD	SW CONTAMINATED SOIL	42.72	TN

Driver: _____

Weighmaster: _____

CARTERJ

Indemnification. Customer agrees, by signature above, to indemnify, hold harmless, and defend Republic Services, Inc., its subsidiaries, affiliates, employees, officers and directors from and against any and all liabilities, claims, penalties, forfeitures, suits and the costs and expenses incident thereto, including costs of defense, settlement, and reasonable attorney's fees, which may be incurred, as a result of death or injuries to any person, or damage to any property, contamination of or adverse effects on the environment, caused in whole or in part by the Customer, its employees, or subcontractors in disposing waste at this Facility. In the event Customer delivers Unacceptable Waste (as determined by Republic) Customer agrees to assume all expenses and obligations with the removal and/or resolution of any effects caused by the delivery of such Unacceptable Waste.

Indemnización. Cliente acuerda indemnizar, mantener inmune, y defender Republic Services, Inc., sus subsidiarios, compañías, divisiones, empleados, oficiales y directores contra de cualquiera y de todas responsabilidades, demandas, penas, pérdidas, juicios, pleitos y los costos incidente además, incluyendo costos de defensa, de acuerdo judicial, y de honorarios razonables del abogado, que pueden ser incurridos en, o como resultado de, la muerte o herida personal a cualquier persona, o daños a cualquier característica, propiedad, contaminación de la tierra o efectos ilícitos en esta Facilidad, causado entero o en parte por el cliente, sus empleados, o sus subcontratistas en botar basura en esta Facilidad. En el caso que el Cliente entrega, bota, basura (según lo determinado por Republic) en este Establecimiento basura inaceptable en los reglamentos de este Establecimiento, el Cliente se compromete asumir todos los costos y obligaciones con el retiro y/o la resolución de cualquier dano(s) causado por la entrega de tal basura inaceptable.



NON-HAZARDOUS WASTE MANIFEST

MANIFEST # 12081

GENERATOR INFORMATION

Generator Name: Tronox LLC

Address: P.O. Box 55

City: Henderson County: Clark

State: NV Zip: 89009

Site Location (if different): 560 W. Lake Mead

Henderson, NV 89015 (702) 592-7727

CUSTOMER/BILLING INFORMATION

Billing Name: NGE LLC c/o Northgate Environment Management

Address: 300 Frank Ogawa Plaza, Ste 510

City: Oakland County: Alameda

State: CA Zip: 94612

Republic Services Approval #	Description of Waste	Volume/Weight	Expiration Date	Container Type
38251011244	Soil for disposal	42.72 TN	12-31-2011	Tractor with Dump Trailer(s)
	RZ- #			

*Attach Additional Sheet if necessary

I hereby certify that the above-described materials are non-hazardous wastes as defined by 40 CFR 261 or any applicable state law. Further, that the above named materials are properly classified, described, packaged, marked and labeled, and are in proper condition for transportation according to the applicable regulations of the Department of Transportation.

Susan Crowley

Generator/Authorized Agent Name

Signature

Date Shipped

TRANSPORTER INFORMATION

Transporter Name: Las Vegas Paving

DOT # 191949

Address: 4420 S. Decatur

Truck Number: HR 17

Las Vegas, NV 89103

Phone Number: (702) 353-4355

I certify no hazardous waste or other regulated substance was knowingly introduced to the waste while in my custody. The waste transported in this vehicle is the waste identified above, to the best of my knowledge.

Name of Authorized Agent

Signature

10-7-10
Date Delivered

DISPOSAL SITE INFORMATION

Site Name: Apex Regional Landfill

Phone No. (702) 599-5920

Address: 13550 U.S. Hwy 93 Las Vegas, NV

I hereby acknowledge receipt of the above described materials

JASON CARTER

Name (Print or Type)

Signature

10/7/10
Date Received

81 Environmental Tech
13550 N Highway 93
Las Vegas, NV 89165

Ticket Type: INBOUND INVOICE

Ticket Number: 1994
Date: 10/07/2010
Time In: 5:33 pm
Time Out: 5:56 pm

Customer: 001011 - NGE, LLC c/o Northgate Environ Mgmt

Vehicle/Container: 60573P
Contract: Northgate Env. On Site Soils 3825 11
Comment: 3825-10-11244

Gross Weight: 134,560 LB Manual In
Tare Weight: 57,560 LB Manual Out
Net Weight: 77000 LB
Net Tons: 38.50

BOL: 12083

Origin	Yards	Material	Billing Quantity
Not Applicable	0.00 YD	SW CONTAMINATED SOIL	38.50 TN

Driver:



Weighmaster:

CARTERJ

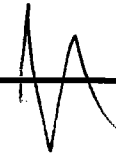

Indemnification. Customer agrees, by signature above, to indemnify, hold harmless, and defend Republic Services, Inc., its subsidiaries, affiliates, employees, officers and directors from and against any and all liabilities, claims, penalties, forfeitures, suits and the costs and expenses incident thereto, including costs of defense, settlement, and reasonable attorney's fees, which may be incurred, as a result of death or injuries to any person, or damage to any property, contamination of or adverse effects on the environment, caused in whole or in part by the Customer, its employees, or subcontractors in disposing waste at this Facility. In the event Customer delivers Unacceptable Waste (as determined by Republic) Customer agrees to assume all expenses and obligations with the removal and/or resolution of any effects caused by the delivery of such Unacceptable Waste.

Indemnización. Cliente acuerda indemnizar, mantener inmune, y defender Republic Services, Inc., sus subsidiarios, compañías, divisiones, empleados, oficiales y directores contra de cualquiera y de todas responsabilidades, demandas, penas, pérdidas, juicios, pleitos y los costos incidente además, incluyendo costos de defensa, de acuerdo judicial, y de honorarios razonables del abogado, que pueden ser incurridos en, o como resultado de, la muerte o herida personal a cualquier persona, o daños a cualquier característica, propiedad, contaminación de la tierra o efectos ilícitos en esta Facilidad, causado entero o en parte por el cliente, sus empleados, o sus subcontratistas en botar basura en esta Facilidad. En el caso que el Cliente entrega, bota, basura (según lo determinado por Republic) en este Establecimiento basura inaceptable en los reglamentos de este Establecimiento, el Cliente se compromete asumir todos los costos y obligaciones con el retiro y/o la resolución de cualquier dano(s) causado por la entrega de tal basura inaceptable.



NON-HAZARDOUS WASTE MANIFEST

MANIFEST # 12083

GENERATOR INFORMATION

Generator Name: Tronox LLC
Address: P.O. Box 55
City: Henderson County: Clark
State: NV Zip: 89009
Site Location (if different): 560 W. Lake Mead
Henderson, NV 89015 (702) 592-7727

CUSTOMER/BILLING INFORMATION

Billing Name: NGE LLC c/o Northgate Environment Management
Address: 300 Frank Ogawa Plaza, Ste 510
City: Oakland County: Alameda
State: CA Zip: 94612

Table with 5 columns: Republic Services Approval #, Description of Waste, Volume/Weight, Expiration Date, Container Type. Row 1: 38251011244, Soil for disposal, 38.50 TN, 12-31-2011, Tractor with Dump Trailer(s). Row 2: RZ- #

*Attach Additional Sheet if necessary

I hereby certify that the above-described materials are non-hazardous wastes as defined by 40 CFR 261 or any applicable state law. Further, that the above named materials are properly classified, described, packaged, marked and labeled, and are in proper condition for transportation according to the applicable regulations of the Department of Transportation.

Susan Crowley
Generator/Authorized Agent Name Signature Date Shipped

TRANSPORTER INFORMATION

Transporter Name: Las Vegas Paving DOT # 191949
Address: 4420 S. Decatur Truck Number:
Las Vegas, NV 89103 Phone Number: (702) 353-4355

I certify no hazardous waste or other regulated substance was knowingly introduced to the waste while in my custody. The waste transported in this vehicle is the waste identified above, to the best of my knowledge.

Name of Authorized Agent Signature Date Delivered 10-7-10

DISPOSAL SITE INFORMATION

Site Name: Apex Regional Landfill Phone No. (702) 599-5920
Address: 13550 U.S. Hwy 93 Las Vegas, NV

I hereby acknowledge receipt of the above described materials

JASON CARTER
Name (Print or Type) Signature Date Received 10/7/10

81 Environmental Tech
13550 N Highway 93
Las Vegas, NV 89165

Ticket Type: INBOUND INVOICE

Ticket Number: 1995
Date: 10/07/2010
Time In: 5:38 pm
Time Out: 6:09 pm

Customer: 001011 - NGE, LLC c/o Northgate Environ Mgmt

Vehicle/Container: 44161A
Contract: Northgate Env. On Site Soils 3825 11
Comment: 3825-10-11244

Gross Weight: 131,480 LB Manual In
Tare Weight: 51,900 LB Manual Out
Net Weight: 79,580 LB
Net Tons: 39.79

BOL: 12082

Origin	Yards	Material	Billing	Quantity
Not Applicable	0.00 YD	SW CONTAMINATED SOIL	39.79	TN

Driver: _____

Weighmaster: _____

CARTERJ

Indemnification. Customer agrees, by signature above, to indemnify, hold harmless, and defend Republic Services, Inc., its subsidiaries, affiliates, employees, officers and directors from and against any and all liabilities, claims, penalties, forfeitures, suits and the costs and expenses incident thereto, including costs of defense, settlement, and reasonable attorney's fees, which may be incurred, as a result of death or injuries to any person, or damage to any property, contamination of or adverse effects on the environment, caused in whole or in part by the Customer, its employees, or subcontractors in disposing waste at this Facility. In the event Customer delivers Unacceptable Waste (as determined by Republic) Customer agrees to assume all expenses and obligations with the removal and/or resolution of any effects caused by the delivery of such Unacceptable Waste.

Indemnización. Cliente acuerda indemnizar, mantener inmune, y defender Republic Services, Inc., sus subsidiarios, compañías, divisiones, empleados, oficiales y directores contra de cualquiera y de todas responsabilidades, demandas, penas, pérdidas, juicios, pleitos y los costos incidente además, incluyendo costos de defensa, de acuerdo judicial, y de honorarios razonables del abogado, que pueden ser incurridos en, o como resultado de, la muerte o herida personal a cualquier persona, o daños a cualquier característica, propiedad, contaminación de la tierra o efectos ilícitos en esta Facilidad, causado entero o en parte por el cliente, sus empleados, o sus subcontratistas en botar basura en esta Facilidad. En el caso que el Cliente entrega, bota, basura (según lo determinado por Republic) en este Establecimiento basura inaceptable en los reglamentos de este Establecimiento, el Cliente se compromete asumir todos los costos y obligaciones con el retiro y/o la resolución de cualquier dano(s) causado por la entrega de tal basura inaceptable.



NON-HAZARDOUS WASTE MANIFEST

MANIFEST # 12082

GENERATOR INFORMATION

Generator Name: Tronox LLC

Address: P.O. Box 55

City: Henderson County: Clark

State: NV Zip: 89009

Site Location (if different): 560 W. Lake Mead

Henderson, NV 89015 (702) 592-7727

CUSTOMER/BILLING INFORMATION

Billing Name: NGE LLC c/o Northgate Environment Management

Address: 300 Frank Ogawa Plaza, Ste 510

City: Oakland County: Alameda

State: CA Zip: 94612

Table with 5 columns: Republic Services Approval #, Description of Waste, Volume/Weight, Expiration Date, Container Type. Row 1: 38251011244, Soil for disposal, 39.79, 12-31-2011, Tractor with Dump Trailer(s). Row 2: RZ- #

*Attach Additional Sheet if necessary

I hereby certify that the above-described materials are non-hazardous wastes as defined by 40 CFR 261 or any applicable state law. Further, that the above named materials are properly classified, described, packaged, marked and labeled, and are in proper condition for transportation according to the applicable regulations of the Department of Transportation.

Susan Crowley

Signature of Susan Crowley

Generator/Authorized Agent Name

Signature

Date Shipped

TRANSPORTER INFORMATION

Transporter Name: Las Vegas Paving

DOT # 191949

Address: 4420 S. Decatur

Truck Number: K005

Las Vegas, NV 89103

Phone Number: (702) 353-4355

I certify no hazardous waste or other regulated substance was knowingly introduced to the waste while in my custody. The waste transported in this vehicle is the waste identified above, to the best of my knowledge.

Signature of Authorized Agent

10-7-10

Name of Authorized Agent

Signature

Date Delivered

DISPOSAL SITE INFORMATION

Site Name: Apex Regional Landfill

Phone No. (702) 599-5920

Address: 13550 U.S. Hwy 93 Las Vegas, NV

I hereby acknowledge receipt of the above described materials

JASON CARTER

Signature of Jason Carter

10/7/10

Name (Print or Type)

Signature

Date Received

81 Environmental Tech
13550 N Highway 93
Las Vegas, NV 89165

Ticket Type: INBOUND INVOICE

Ticket Number: 1996
Date: 10/07/2010
Time In: 7:51 pm
Time Out: 8:13 pm

Customer: 001011 - NGE, LLC c/o Northgate Environ Mgmt

Vehicle/Container: 81494P
Contract: Northgate Env. On Site Soils 3825 11
Comment: 3825 10 11244

Gross Weight: 120,960 LB Manual In
Tare Weight: 51,200 LB Manual Out
Net Weight: 69760 LB
Net Tons: 34.88

BOL: 12084

Origin	Yards	Material	Billing	Quantity
Not Applicable	0.00 YD	SW CONTAMINATED SOIL	34.88	TN

Driver: _____

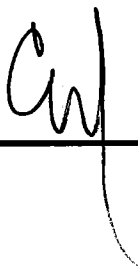

Weighmaster: _____

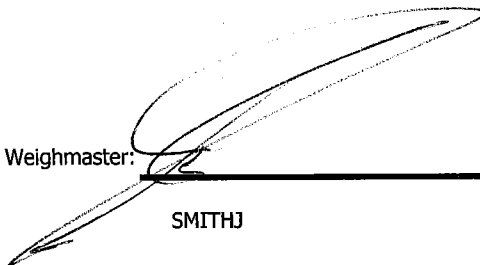
SMITHJ

Indemnification. Customer agrees, by signature above, to indemnify, hold harmless, and defend Republic Services, Inc., its subsidiaries, affiliates, employees, officers and directors from and against any and all liabilities, claims, penalties, forfeitures, suits and the costs and expenses incident thereto, including costs of defense, settlement, and reasonable attorney's fees, which may be incurred, as a result of death or injuries to any person, or damage to any property, contamination of or adverse effects on the environment, caused in whole or in part by the Customer, its employees, or subcontractors in disposing waste at this Facility. In the event Customer delivers Unacceptable Waste (as determined by Republic) Customer agrees to assume all expenses and obligations with the removal and/or resolution of any effects caused by the delivery of such Unacceptable Waste.

Indemnización. Cliente acuerda indemnizar, mantener inmune, y defender Republic Services, Inc., sus subsidiarios, compañías, divisiones, empleados, oficiales y directores contra de cualquiera y de todas responsabilidades, demandas, penas, pérdidas, juicios, pleitos y los costos incidente además, incluyendo costos de defensa, de acuerdo judicial, y de honorarios razonables del abogado, que pueden ser incurridos en, o como resultado de, la muerte o herida personal a cualquier persona, o daños a cualquier característica, propiedad, contaminación de la tierra o efectos ilícitos en esta Facilidad. En el caso que el Cliente entrega, bota, basura (según lo determinado por Republic) en este Establecimiento basura inaceptable en los reglamentos de este Establecimiento, el Cliente se compromete asumir todos los costos y obligaciones con el retiro y/o la resolución de cualquier dano(s) causado por la entrega de tal basura inaceptable.



NON-HAZARDOUS WASTE MANIFEST

MANIFEST # 12084

GENERATOR INFORMATION

Generator Name: Tronox LLC

Address: P.O. Box 55

City: Henderson County: Clark

State: NV Zip: 89009

Site Location (if different): 560 W. Lake Mead
Henderson, NV 89015 (702) 592-7727

CUSTOMER/BILLING INFORMATION

Billing Name: NGE LLC c/o Northgate Environment Management

Address: 300 Frank Ogawa Plaza, Ste 510

City: Oakland County: Alameda

State: CA Zip: 94612

Table with 5 columns: Republic Services Approval #, Description of Waste, Volume/Weight, Expiration Date, Container Type. Row 1: 38251011244, Soil for disposal, 39.88 TW, 12-31-2011, Tractor with Dump Trailer(s).

*Attach Additional Sheet if necessary

I hereby certify that the above-described materials are non-hazardous wastes as defined by 40 CFR 261 or any applicable state law. Further, that the above named materials are properly classified, described, packaged, marked and labeled, and are in proper condition for transportation according to the applicable regulations of the Department of Transportation.

Susan Crowley (Name), Tom Crowley (Signature), Date Shipped

TRANSPORTER INFORMATION

Transporter Name: Las Vegas Paving

DOT # 191949

Address: 4420 S. Decatur

Truck Number: 125

Las Vegas, NV 89103

Phone Number: (702) 353-4355

I certify no hazardous waste or other regulated substance was knowingly introduced to the waste while in my custody. The waste transported in this vehicle is the waste identified above, to the best of my knowledge.

Calvin Paguyo (Name), Calvin Paguyo (Signature), 10-07-10 (Date Delivered)

DISPOSAL SITE INFORMATION

Site Name: Apex Regional Landfill

Phone No. (702) 599-5920

Address: 13550 U.S. Hwy 93 Las Vegas, NV

I hereby acknowledge receipt of the above described materials

Name (Print or Type), Signature, Date Received

81 Environmental Tech
13550 N Highway 93
Las Vegas, NV 89165

Ticket Type: INBOUND INVOICE

Ticket Number: 1997
Date: 10/07/2010
Time In: 7:54 pm
Time Out: 8:18 pm

Customer: 001011 - NGE, LLC c/o Northgate Environ Mgmt

Vehicle/Container: 81495P
Contract: Northgate Env. On Site Soils 3825 11
Comment: 3825 10 11244

Gross Weight: 125,960 LB Manual In
Tare Weight: 50,660 LB Manual Out
Net Weight: 75300 LB
Net Tons: 37.65

BOL: 12085

Origin	Yards	Material	Billing	Quantity
Not Applicable	0.00 YD	SW CONTAMINATED SOIL	37.65	TN

Driver:



Weighmaster:

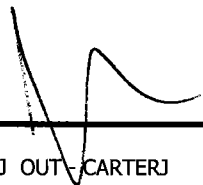

IN - SMITHJ OUT - CARTERJ

Indemnification. Customer agrees, by signature above, to indemnify, hold harmless, and defend Republic Services, Inc., its subsidiaries, affiliates, employees, officers and directors from and against any and all liabilities, claims, penalties, forfeitures, suits and the costs and expenses incident thereto, including costs of defense, settlement, and reasonable attorney's fees, which may be incurred, as a result of death or injuries to any person, or damage to any property, contamination of or adverse effects on the environment, caused in whole or in part by the Customer, its employees, or subcontractors in disposing waste at this Facility. In the event Customer delivers Unacceptable Waste (as determined by Republic) Customer agrees to assume all expenses and obligations with the removal and/or resolution of any effects caused by the delivery of such Unacceptable Waste.

Indemnización. Cliente acuerda indemnizar, mantener inmune, y defender Republic Services, Inc., sus subsidiarios, compañías, divisiones, empleados, oficiales y directores contra de cualquiera y de todas responsabilidades, demandas, penas, pérdidas, juicios, pleitos y los costos incidente además, incluyendo costos de defensa, de acuerdo judicial, y de honorarios razonables del abogado, que pueden ser incurridos en, o como resultado de, la muerte o herida personal a cualquier persona, o daños a cualquier característica, propiedad, contaminación de la tierra o efectos ilícitos en esta Facilidad, causado entero o en parte por el cliente, sus empleados, o sus subcontratistas en botar basura en esta Facilidad. En el caso que el Cliente entrega, bota, basura (según lo determinado por Republic) en este Establecimiento basura inaceptable en los reglamentos de este Establecimiento, el Cliente se compromete asumir todos los costos y obligaciones con el retiro y/o la resolución de cualquier dano(s) causado por la entrega de tal basura inaceptable.



SK 40238

NON-HAZARDOUS WASTE MANIFEST

MANIFEST # 12085

GENERATOR INFORMATION

CUSTOMER/BILLING INFORMATION

Generator Name: Tronox LLC

Billing Name: NGE LLC c/o Northgate Environment Management

Address: P.O. Box 55

Address: 300 Frank Ogawa Plaza, Ste 510

City: Henderson County: Clark

City: Oakland County: Alameda

State: NV Zip: 89009

State: CA Zip: 94612

Site Location (if different): 560 W. Lake Mead
Henderson, NV 89015 (702) 592-7727

Republic Services Approval #	Description of Waste	Volume/Weight	Expiration Date	Container Type
38251011244	Soil for disposal	37.65 TN	12-31-2011	Tractor with Dump Trailer(s)
	RZ- _____ # _____			

*Attach Additional Sheet if necessary

I hereby certify that the above-described materials are non-hazardous wastes as defined by 40 CFR 261 or any applicable state law. Further, that the above named materials are properly classified, described, packaged, marked and labeled, and are in proper condition for transportation according to the applicable regulations of the Department of Transportation.

Susan Crowley [Signature] _____
 Generator/Authorized Agent Name Signature Date Shipped

TRANSPORTER INFORMATION

Transporter Name: Las Vegas Paving DOT # 191949
 Address: 4420 S. Decatur Truck Number: 175
Las Vegas, NV 89103 Phone Number: (702) 353-4355

I certify no hazardous waste or other regulated substance was knowingly introduced to the waste while in my custody. The waste transported in this vehicle is the waste identified above, to the best of my knowledge.

Larry Hornsbeiger [Signature] 10-7-10
 Name of Authorized Agent Signature Date Delivered

DISPOSAL SITE INFORMATION

Site Name: Apex Regional Landfill Phone No. (702) 599-5920
 Address: 13550 U.S. Hwy 93 Las Vegas, NV

I hereby acknowledge receipt of the above described materials
JASON CARTER [Signature] 10/7/10
 Name (Print or Type) Signature Date Received

81 Environmental Tech
13550 N Highway 93
Las Vegas, NV 89165

Ticket Type: INBOUND INVOICE

Ticket Number: 1998
Date: 10/07/2010
Time In: 7:58 pm
Time Out: 8:22 pm

Customer: 001011 - NGE, LLC c/o Northgate Environ Mgmt

Vehicle/Container: 81496P
Contract: Northgate Env. On Site Soils 3825 11
Comment: 3825 10 11244

Gross Weight: 122,460 LB Manual In
Tare Weight: 51,440 LB Manual Out
Net Weight: 71020 LB
Net Tons: 35.51

BOL: 12086

Origin	Yards	Material	Billing	Quantity
Not Applicable	0.00 YD	SW CONTAMINATED SOIL	35.51	TN

Driver:



Weighmaster:

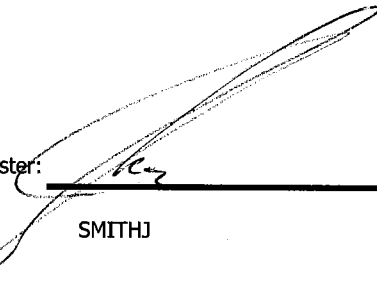

SMITHJ

Indemnification. Customer agrees, by signature above, to indemnify, hold harmless, and defend Republic Services, Inc., its subsidiaries, affiliates, employees, officers and directors from and against any and all liabilities, claims, penalties, forfeitures, suits and the costs and expenses incident thereto, including costs of defense, settlement, and reasonable attorney's fees, which may be incurred, as a result of death or injuries to any person, or damage to any property, contamination of or adverse effects on the environment, caused in whole or in part by the Customer, its employees, or subcontractors in disposing waste at this Facility. In the event Customer delivers Unacceptable Waste (as determined by Republic) Customer agrees to assume all expenses and obligations with the removal and/or resolution of any effects caused by the delivery of such Unacceptable Waste.

Indemnización. Cliente acuerda indemnizar, mantener inmune, y defender Republic Services, Inc., sus subsidiarios, compañías, divisiones, empleados, oficiales y directores contra de cualquiera y de todas responsabilidades, demandas, penas, pérdidas, juicios, pleitos y los costos incidente además, incluyendo costos de defensa, de acuerdo judicial, y de honorarios razonables del abogado, que pueden ser incurridos en, o como resultado de, la muerte o herida personal a cualquier persona, o daños a cualquier característica, propiedad, contaminación de la tierra o efectos ilícitos en esta Facilidad, causado entero o en parte por el cliente, sus empleados, o sus subcontratistas en botar basura en esta Facilidad. En el caso que el Cliente entrega, bota, basura (según lo determinado por Republic) en este Establecimiento basura inaceptable en los reglamentos de este Establecimiento, el Cliente se compromete asumir todos los costos y obligaciones con el retiro y/o la resolución de cualquier dano(s) causado por la entrega de tal basura inaceptable.



NON-HAZARDOUS WASTE MANIFEST

MANIFEST # 12086

GENERATOR INFORMATION

Generator Name: Tronox LLC

Address: P.O. Box 55

City: Henderson County: Clark

State: NV Zip: 89009

Site Location (if different): 560 W. Lake Mead

Henderson, NV 89015 (702) 592-7727

CUSTOMER/BILLING INFORMATION

Billing Name: NGE LLC c/o Northgate Environment Management

Address: 300 Frank Ogawa Plaza, Ste 510

City: Oakland County: Alameda

State: CA Zip: 94612

Table with 5 columns: Republic Services Approval #, Description of Waste, Volume/Weight, Expiration Date, Container Type. Row 1: 38251011244, Soil for disposal, 25.5170, 12-31-2011, Tractor with Dump Trailer(s). Row 2: RZ- #

*Attach Additional Sheet if necessary

I hereby certify that the above-described materials are non-hazardous wastes as defined by 40 CFR 261 or any applicable state law. Further, that the above named materials are properly classified, described, packaged, marked and labeled, and are in proper condition for transportation according to the applicable regulations of the Department of Transportation.

Susan Crowley (Signature) Generator/Authorized Agent Name Date Shipped

TRANSPORTER INFORMATION

Transporter Name: Las Vegas Paving

DOT # 191949

Address: 4420 S. Decatur

Truck Number: 145

Las Vegas, NV 89103

Phone Number: (702) 353-4355

I certify no hazardous waste or other regulated substance was knowingly introduced to the waste while in my custody. The waste transported in this vehicle is the waste identified above, to the best of my knowledge.

Harry Mc Giral (Signature) Name of Authorized Agent Date Delivered 10-8-10

DISPOSAL SITE INFORMATION

Site Name: Apex Regional Landfill

Phone No. (702) 599-5920

Address: 13550 U.S. Hwy 93 Las Vegas, NV

I hereby acknowledge receipt of the above described materials (Signature) Name (Print or Type) Date Received 10-7-10

81 Environmental Tech
13550 N Highway 93
Las Vegas, NV 89165

Ticket Type: INBOUND INVOICE

Ticket Number: 1999
Date: 10/07/2010
Time In: 8:00 pm
Time Out: 8:24 pm

Customer: 001011 - NGE, LLC c/o Northgate Environ Mgmt

Vehicle/Container: 34330A
Contract: Northgate Env. On Site Soils 3825 11
Comment: 3825 10 11244

Gross Weight: 124,640 LB Manual In
Tare Weight: 53,580 LB Manual Out
Net Weight: 71060 LB
Net Tons: 35.53

BOL: 12087

Origin	Yards	Material	Billing	Quantity
Not Applicable	0.00 YD	SW CONTAMINATED SOIL	35.53	TN

Driver:

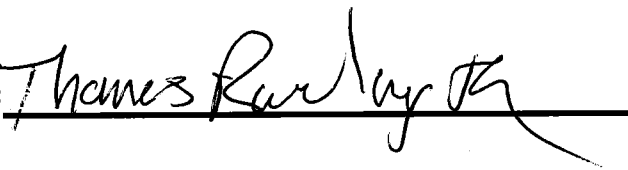

Weighmaster:

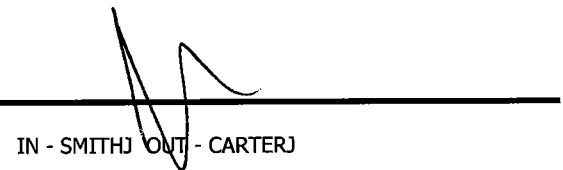

IN - SMITHJ OUT - CARTERJ

Indemnification. Customer agrees, by signature above, to indemnify, hold harmless, and defend Republic Services, Inc., its subsidiaries, affiliates, employees, officers and directors from and against any and all liabilities, claims, penalties, forfeitures, suits and the costs and expenses incident thereto, including costs of defense, settlement, and reasonable attorney's fees, which may be incurred, as a result of death or injuries to any person, or damage to any property, contamination of or adverse effects on the environment, caused in whole or in part by the Customer, its employees, or subcontractors in disposing waste at this Facility. In the event Customer delivers Unacceptable Waste (as determined by Republic) Customer agrees to assume all expenses and obligations with the removal and/or resolution of any effects caused by the delivery of such Unacceptable Waste.

Indemnización. Cliente acuerda indemnizar, mantener inmune, y defender Republic Services, Inc., sus subsidiarios, compañías, divisiones, empleados, oficiales y directores contra de cualquiera y de todas responsabilidades, demandas, penas, pérdidas, juicios, pleitos y los costos incidente además, incluyendo costos de defensa, de acuerdo judicial, y de honorarios razonables del abogado, que pueden ser incurridos en, o como resultado de, la muerte o herida personal a cualquier persona, o daños a cualquier característica, propiedad, contaminación de la tierra o efectos ilícitos en esta Facilidad, causado entero o en parte por el cliente, sus empleados, o sus subcontratistas en botar basura en esta Facilidad. En el caso que el Cliente entrega, bota, basura (según lo determinado por Republic) en este Establecimiento basura inaceptable en los reglamentos de este Establecimiento, el Cliente se compromete asumir todos los costos y obligaciones con el retiro y/o la resolución de cualquier dano(s) causado por la entrega de tal basura inaceptable.



NON-HAZARDOUS WASTE MANIFEST

MANIFEST # 12087

GENERATOR INFORMATION

Generator Name: Tronox LLC

Address: P.O. Box 55

City: Henderson County: Clark

State: NV Zip: 89009

Site Location (if different): 560 W. Lake Mead

Henderson, NV 89015 (702) 592-7727

CUSTOMER/BILLING INFORMATION

Billing Name: NGE LLC c/o Northgate Environment Management

Address: 300 Frank Ogawa Plaza, Ste 510

City: Oakland County: Alameda

State: CA Zip: 94612

Republic Services Approval #	Description of Waste	Volume/Weight	Expiration Date	Container Type
38251011244	Soil for disposal	35.53 TN	12-31-2011	Tractor with Dump Trailer(s)
	RZ- #			

*Attach Additional Sheet if necessary

I hereby certify that the above-described materials are non-hazardous wastes as defined by 40 CFR 261 or any applicable state law. Further, that the above named materials are properly classified, described, packaged, marked and labeled, and are in proper condition for transportation according to the applicable regulations of the Department of Transportation.

Susan Crowley
Generator/Authorized Agent Name Signature Date Shipped

TRANSPORTER INFORMATION

Transporter Name: Las Vegas Paving DOT # 191949

Address: 4420 S. Decatur Truck Number: 981

Las Vegas, NV 89103 Phone Number: (702) 353-4355

I certify no hazardous waste or other regulated substance was knowingly introduced to the waste while in my custody. The waste transported in this vehicle is the waste identified above, to the best of my knowledge.

Tom Rowley
Name of Authorized Agent Signature Date Delivered 10-7-10

DISPOSAL SITE INFORMATION

Site Name: Apex Regional Landfill Phone No. (702) 599-5920

Address: 13550 U.S. Hwy 93 Las Vegas, NV

I hereby acknowledge receipt of the above described materials
Name (Print or Type) Signature Date Received 10/7/10

81 Environmental Tech
13550 N Highway 93
Las Vegas, NV 89165

Ticket Type: INBOUND INVOICE

Ticket Number: 2000
Date: 10/07/2010
Time In: 8:05 pm
Time Out: 8:26 pm

Customer: 001011 - NGE, LLC c/o Northgate Environ Mgmt

Vehicle/Container: 81460P
Contract: Northgate Env. On Site Soils 3825 11
Comment: 3825 10 11244

Gross Weight: 127,660 LB Manual In
Tare Weight: 54,360 LB Manual Out
Net Weight: 73300 LB
Net Tons: 36.65

BOL: 12088

Origin	Yards	Material	Billing	Quantity
Not Applicable	0.00 YD	SW CONTAMINATED SOIL	36.65	TN

Driver: _____

Weighmaster: _____

CARTERJ

Indemnification. Customer agrees, by signature above, to indemnify, hold harmless, and defend Republic Services, Inc., its subsidiaries, affiliates, employees, officers and directors from and against any and all liabilities, claims, penalties, forfeitures, suits and the costs and expenses incident thereto, including costs of defense, settlement, and reasonable attorney's fees, which may be incurred, as a result of death or injuries to any person, or damage to any property, contamination of or adverse effects on the environment, caused in whole or in part by the Customer, its employees, or subcontractors in disposing waste at this Facility. In the event Customer delivers Unacceptable Waste (as determined by Republic) Customer agrees to assume all expenses and obligations with the removal and/or resolution of any effects caused by the delivery of such Unacceptable Waste.

Indemnización. Cliente acuerda indemnizar, mantener inmune, y defender Republic Services, Inc., sus subsidiarios, compañías, divisiones, empleados, oficiales y directores contra de cualquiera y de todas responsabilidades, demandas, penas, pérdidas, juicios, pleitos y los costos incidente además, incluyendo costos de defensa, de acuerdo judicial, y de honorarios razonables del abogado, que pueden ser incurridos en, o como resultado de, la muerte o herida personal a cualquier persona, o daños a cualquier característica, propiedad, contaminación de la tierra o efectos ilícitos en esta Facilidad, causado entero o en parte por el cliente, sus empleados, o sus subcontratistas en botar basura en esta Facilidad. En el caso que el Cliente entrega, bota, basura (según lo determinado por Republic) en este Establecimiento basura inaceptable en los reglamentos de este Establecimiento, el Cliente se compromete asumir todos los costos y obligaciones con el retiro y/o la resolución de cualquier dano(s) causado por la entrega de tal basura inaceptable.



NON-HAZARDOUS WASTE MANIFEST

MANIFEST # 12088

GENERATOR INFORMATION

Generator Name: Tronox LLC

Address: P.O. Box 55

City: Henderson County: Clark

State: NV Zip: 89009

Site Location (if different): 560 W. Lake Mead

Henderson, NV 89015 (702) 592-7727

CUSTOMER/BILLING INFORMATION

Billing Name: NGE LLC c/o Northgate Environment Management

Address: 300 Frank Ogawa Plaza, Ste 510

City: Oakland County: Alameda

State: CA Zip: 94612

Republic Services Approval #	Description of Waste	Volume/Weight	Expiration Date	Container Type
38251011244	Soil for disposal	36.65 TN	12-31-2011	Tractor with Dump Trailer(s)
	RZ- #			

*Attach Additional Sheet if necessary

I hereby certify that the above-described materials are non-hazardous wastes as defined by 40 CFR 261 or any applicable state law. Further, that the above named materials are properly classified, described, packaged, marked and labeled, and are in proper condition for transportation according to the applicable regulations of the Department of Transportation.

Susan Crowley (Signature) Generator/Authorized Agent Name Date Shipped

TRANSPORTER INFORMATION

Transporter Name: Las Vegas Paving

DOT # 191949

Address: 4420 S. Decatur

Truck Number: 27

Las Vegas, NV 89103

Phone Number: (702) 353-4355

I certify no hazardous waste or other regulated substance was knowingly introduced to the waste while in my custody. The waste transported in this vehicle is the waste identified above, to the best of my knowledge.

Daniel Cardenas (Signature) Name of Authorized Agent Date Delivered 10-7-2010

DISPOSAL SITE INFORMATION

Site Name: Apex Regional Landfill

Phone No. (702) 599-5920

Address: 13550 U.S. Hwy 93 Las Vegas, NV

I hereby acknowledge receipt of the above described materials

JASON CARTER (Signature) Name (Print or Type) Date Received 10/7/10

81 Environmental Tech
13550 N Highway 93
Las Vegas, NV 89165

Ticket Type: INBOUND INVOICE

Ticket Number: 2001
Date: 10/07/2010
Time In: 8:07 pm
Time Out: 8:27 pm

Customer: 001011 - NGE, LLC c/o Northgate Environ Mgmt

Vehicle/Container: 35903A
Contract: Northgate Env. On Site Soils 3825 11
Comment: 3825 10 11244

Gross Weight: 128,320 LB Manual In
Tare Weight: 57,680 LB Manual Out
Net Weight: 70640 LB
Net Tons: 35.32

BOL: 12089

Origin	Yards	Material	Billing	Quantity
Not Applicable	0.00 YD	SW CONTAMINATED SOIL	35.32	TN

Driver: Jay Mason

Weighmaster: [Signature]

IN - SMITHJ OUT - CARTERJ

Indemnification. Customer agrees, by signature above, to indemnify, hold harmless, and defend Republic Services, Inc., its subsidiaries, affiliates, employees, officers and directors from and against any and all liabilities, claims, penalties, forfeitures, suits and the costs and expenses incident thereto, including costs of defense, settlement, and reasonable attorney's fees, which may be incurred, as a result of death or injuries to any person, or damage to any property, contamination of or adverse effects on the environment, caused in whole or in part by the Customer, its employees, or subcontractors in disposing waste at this Facility. In the event Customer delivers Unacceptable Waste (as determined by Republic) Customer agrees to assume all expenses and obligations with the removal and/or resolution of any effects caused by the delivery of such Unacceptable Waste.

Indemnización. Cliente acuerda indemnizar, mantener inmune, y defender Republic Services, Inc., sus subsidiarios, compañías, divisiones, empleados, oficiales y directores contra de cualquiera y de todas responsabilidades, demandas, penas, pérdidas, juicios, pleitos y los costos incidente además, incluyendo costos de defensa, de acuerdo judicial, y de honorarios razonables del abogado, que pueden ser incurridos en, o como resultado de, la muerte o herida personal a cualquier persona, o daños a cualquier característica, propiedad, contaminación de la tierra o efectos ilícitos en esta Facilidad, causado entero o en parte por el cliente, sus empleados, o sus subcontratistas en botar basura en esta Facilidad. En el caso que el Cliente entrega, bota, basura (según lo determinado por Republic) en este Establecimiento basura inaceptable en los reglamentos de este Establecimiento, el Cliente se compromete asumir todos los costos y obligaciones con el retiro y/o la resolución de cualquier dano(s) causado por la entrega de tal basura inaceptable.



NON-HAZARDOUS WASTE MANIFEST

MANIFEST # 12089

GENERATOR INFORMATION

Generator Name: Tronox LLC

Address: P.O. Box 55

City: Henderson County: Clark

State: NV Zip: 89009

Site Location (if different): 560 W. Lake Mead

Henderson, NV 89015 (702) 592-7727

CUSTOMER/BILLING INFORMATION

Billing Name: NGE LLC c/o Northgate Environment Management

Address: 300 Frank Ogawa Plaza, Ste 510

City: Oakland County: Alameda

State: CA Zip: 94612

Republic Services Approval #	Description of Waste	Volume/Weight	Expiration Date	Container Type
38251011244	Soil for disposal	35.32 TN	12-31-2011	Tractor with Dump Trailer(s)
	RZ- _____ # _____			

*Attach Additional Sheet if necessary

I hereby certify that the above-described materials are non-hazardous wastes as defined by 40 CFR 261 or any applicable state law. Further, that the above named materials are properly classified, described, packaged, marked and labeled, and are in proper condition for transportation according to the applicable regulations of the Department of Transportation.

Susan Crowley [Signature] _____
 Generator/Authorized Agent Name Signature Date Shipped

TRANSPORTER INFORMATION

Transporter Name: Las Vegas Paving

DOT # 191949

Address: 4420 S. Decatur

Truck Number: 07

Las Vegas, NV 89103

Phone Number: (702) 353-4355

I certify no hazardous waste or other regulated substance was knowingly introduced to the waste while in my custody. The waste transported in this vehicle is the waste identified above, to the best of my knowledge.

Wardco [Signature] 10-7-10
 Name of Authorized Agent Signature Date Delivered

DISPOSAL SITE INFORMATION

Site Name: Apex Regional Landfill

Phone No. (702) 599-5920

Address: 13550 U.S. Hwy 93 Las Vegas, NV

I hereby acknowledge receipt of the above described materials

JASON CARTER [Signature] 10/7/10
 Name (Print or Type) Signature Date Received

81 Environmental Tech
13550 N Highway 93
Las Vegas, NV 89165

Ticket Type: INBOUND INVOICE

Ticket Number: 2002
Date: 10/07/2010
Time In: 8:11 pm
Time Out: 8:33 pm

Customer: 001011 - NGE, LLC c/o Northgate Environ Mgmt

Vehicle/Container: 86053P
Contract: Northgate Env. On Site Soils 3825 11
Comment: 3825 10 11244

Gross Weight: 124,120 LB Manual In
Tare Weight: 54,780 LB Manual Out
Net Weight: 69340 LB
Net Tons: 34.67

BOL: 12090

Origin	Yards	Material	Billing	Quantity
Not Applicable	0.00 YD	SW CONTAMINATED SOIL	34.67	TN

Driver: _____



Weighmaster: _____

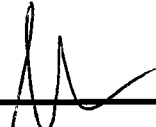

IN - SMITHJ OUT - CARTERJ

Indemnification. Customer agrees, by signature above, to indemnify, hold harmless, and defend Republic Services, Inc., its subsidiaries, affiliates, employees, officers and directors from and against any and all liabilities, claims, penalties, forfeitures, suits and the costs and expenses incident thereto, including costs of defense, settlement, and reasonable attorney's fees, which may be incurred, as a result of death or injuries to any person, or damage to any property, contamination of or adverse effects on the environment, caused in whole or in part by the Customer, its employees, or subcontractors in disposing waste at this Facility. In the event Customer delivers Unacceptable Waste (as determined by Republic) Customer agrees to assume all expenses and obligations with the removal and/or resolution of any effects caused by the delivery of such Unacceptable Waste.

Indemnización. Cliente acuerda indemnizar, mantener inmune, y defender Republic Services, Inc., sus subsidiarios, compañías, divisiones, empleados, oficiales y directores contra de cualquiera y de todas responsabilidades, demandas, penas, pérdidas, juicios, pleitos y los costos incidente además, incluyendo costos de defensa, de acuerdo judicial, y de honorarios razonables del abogado, que pueden ser incurridos en, o como resultado de, la muerte o herida personal a cualquier persona, o daños a cualquier característica, propiedad, contaminación de la tierra o efectos ilícitos en esta Facilidad, causado entero o en parte por el cliente, sus empleados, o sus subcontratistas en botar basura en esta Facilidad. En el caso que el Cliente entrega, bota, basura (según lo determinado por Republic) en este Establecimiento basura inaceptable en los reglamentos de este Establecimiento, el Cliente se compromete asumir todos los costos y obligaciones con el retiro y/o la resolución de cualquier dano(s) causado por la entrega de tal basura inaceptable.



NON-HAZARDOUS WASTE MANIFEST

MANIFEST # 12090

GENERATOR INFORMATION

Generator Name: Tronox LLC

Address: P.O. Box 55

City: Henderson County: Clark

State: NV Zip: 89009

Site Location (if different): 560 W. Lake Mead
Henderson, NV 89015 (702) 592-7727

CUSTOMER/BILLING INFORMATION

Billing Name: NGE LLC c/o Northgate Environment Management

Address: 300 Frank Ogawa Plaza, Ste 510

City: Oakland County: Alameda

State: CA Zip: 94612

Table with 5 columns: Republic Services Approval #, Description of Waste, Volume/Weight, Expiration Date, Container Type. Row 1: 38251011244, Soil for disposal, 34.67 TN, 12-31-2011, Tractor with Dump Trailer(s).

*Attach Additional Sheet if necessary

I hereby certify that the above-described materials are non-hazardous wastes as defined by 40 CFR 261 or any applicable state law. Further, that the above named materials are properly classified, described, packaged, marked and labeled, and are in proper condition for transportation according to the applicable regulations of the Department of Transportation.

Susan Crowley (Signature)
Generator/Authorized Agent Name Signature Date Shipped

TRANSPORTER INFORMATION

Transporter Name: Las Vegas Paving

DOT # 191949

Address: 4420 S. Decatur

Truck Number: 261

Las Vegas, NV 89103

Phone Number: (702) 353-4355

I certify no hazardous waste or other regulated substance was knowingly introduced to the waste while in my custody. The waste transported in this vehicle is the waste identified above, to the best of my knowledge.

(Signature) PATRICK (Signature) 700714
Name of Authorized Agent Signature Date Delivered

DISPOSAL SITE INFORMATION

Site Name: Apex Regional Landfill

Phone No. (702) 599-5920

Address: 13550 U.S. Hwy 93 Las Vegas, NV

I hereby acknowledge receipt of the above described materials
JASON CARTER (Signature) 10/7/10
Name (Print or Type) Signature Date Received

81 Environmental Tech
13550 N Highway 93
Las Vegas, NV 89165

Ticket Type: INBOUND INVOICE

Ticket Number: 2003
Date: 10/07/2010
Time In: 8:12 pm
Time Out: 8:34 pm

Customer: 001011 - NGE, LLC c/o Northgate Environ Mgmt

Vehicle/Container: 82418P
Contract: Northgate Env. On Site Soils 3825 11
Comment: 3825 10 11244

Gross Weight: 133,020 LB Manual In
Tare Weight: 62,720 LB Manual Out
Net Weight: 70300 LB
Net Tons: 35.15

BOL: 12091

Origin	Yards	Material	Billing	Quantity
Not Applicable	0.00 YD	SW CONTAMINATED SOIL	35.15	TN

Driver: _____

Weighmaster: _____

IN - SMITHJ OUT - CARTERJ

Indemnification. Customer agrees, by signature above, to indemnify, hold harmless, and defend Republic Services, Inc., its subsidiaries, affiliates, employees, officers and directors from and against any and all liabilities, claims, penalties, forfeitures, suits and the costs and expenses incident thereto, including costs of defense, settlement, and reasonable attorney's fees, which may be incurred, as a result of death or injuries to any person, or damage to any property, contamination of or adverse effects on the environment, caused in whole or in part by the Customer, its employees, or subcontractors in disposing waste at this Facility. In the event Customer delivers Unacceptable Waste (as determined by Republic) Customer agrees to assume all expenses and obligations with the removal and/or resolution of any effects caused by the delivery of such Unacceptable Waste.

Indemnización. Cliente acuerda indemnizar, mantener inmune, y defender Republic Services, Inc., sus subsidiarios, compañías, divisiones, empleados, oficiales y directores contra de cualquiera y de todas responsabilidades, demandas, penas, pérdidas, juicios, pleitos y los costos incidente además, incluyendo costos de defensa, de acuerdo judicial, y de honorarios razonables del abogado, que pueden ser incurridos en, o como resultado de, la muerte o herida personal a cualquier persona, o daños a cualquier característica, propiedad, contaminación de la tierra o efectos ilícitos en esta Facilidad, causado entero o en parte por el cliente, sus empleados, o sus subcontratistas en botar basura en esta Facilidad. En el caso que el Cliente entrega, bota, basura (según lo determinado por Republic) en este Establecimiento basura inaceptable en los reglamentos de este Establecimiento, el Cliente se compromete asumir todos los costos y obligaciones con el retiro y/o la resolución de cualquier dano(s) causado por la entrega de tal basura inaceptable.



NON-HAZARDOUS WASTE MANIFEST

MANIFEST # 12091

GENERATOR INFORMATION

Generator Name: Tronox LLC
Address: P.O. Box 55
City: Henderson County: Clark
State: NV Zip: 89009
Site Location (if different): 560 W. Lake Mead
Henderson, NV 89015 (702) 592-7727

CUSTOMER/BILLING INFORMATION

Billing Name: NGE LLC c/o Northgate Environment Management
Address: 300 Frank Ogawa Plaza, Ste 510
City: Oakland County: Alameda
State: CA Zip: 94612

Table with 5 columns: Republic Services Approval #, Description of Waste, Volume/Weight, Expiration Date, Container Type. Row 1: 38251011244, Soil for disposal, 35.15 TN, 12-31-2011, Tractor with Dump Trailer(s). Row 2: RZ- #

*Attach Additional Sheet if necessary

I hereby certify that the above-described materials are non-hazardous wastes as defined by 40 CFR 261 or any applicable state law. Further, that the above named materials are properly classified, described, packaged, marked and labeled, and are in proper condition for transportation according to the applicable regulations of the Department of Transportation.

Susan Crowley
Generator/Authorized Agent Name Signature Date Shipped

TRANSPORTER INFORMATION

Transporter Name: Las Vegas Paving DOT # 191949
Address: 4420 S. Decatur Truck Number: 220
Las Vegas, NV 89103 Phone Number: (702) 353-4355

I certify no hazardous waste or other regulated substance was knowingly introduced to the waste while in my custody. The waste transported in this vehicle is the waste identified above, to the best of my knowledge.

STEVE TAYLOR
Name of Authorized Agent Signature Date Delivered 10-7-10

DISPOSAL SITE INFORMATION

Site Name: Apex Regional Landfill Phone No. (702) 599-5920
Address: 13550 U.S. Hwy 93 Las Vegas, NV

I hereby acknowledge receipt of the above described materials
JASON CARTER
Name (Print or Type) Signature Date Received 10/7/10

81 Environmental Tech
13550 N Highway 93
Las Vegas, NV 89165

Ticket Type: INBOUND INVOICE

Ticket Number: 2004
Date: 10/07/2010
Time In: 8:19 pm
Time Out: 8:40 pm

Customer: 001011 - NGE, LLC c/o Northgate Environ Mgmt

Vehicle/Container: 76810P
Contract: Northgate Env. On Site Soils 3825 11
Comment: 3825 10 11244

Gross Weight: 126,800 LB Manual In
Tare Weight: 57,540 LB Manual Out
Net Weight: 69,260 LB
Net Tons: 34.63

BOL: 12093

Origin	Yards	Material	Billing	Quantity
Not Applicable	0.00 YD	SW CONTAMINATED SOIL	34.63	TN

Driver: _____

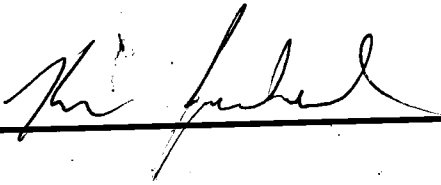

Weighmaster: _____

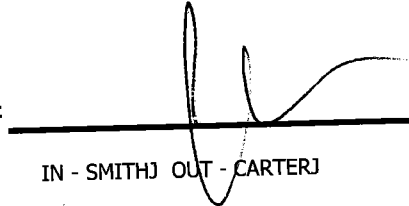

IN - SMITHJ OUT - CARTERJ

Indemnification. Customer agrees, by signature above, to indemnify, hold harmless, and defend Republic Services, Inc., its subsidiaries, affiliates, employees, officers and directors from and against any and all liabilities, claims, penalties, forfeitures, suits and the costs and expenses incident thereto, including costs of defense, settlement, and reasonable attorney's fees, which may be incurred, as a result of death or injuries to any person, or damage to any property, contamination of or adverse effects on the environment, caused in whole or in part by the Customer, its employees, or subcontractors in disposing waste at this Facility. In the event Customer delivers Unacceptable Waste (as determined by Republic) Customer agrees to assume all expenses and obligations with the removal and/or resolution of any effects caused by the delivery of such Unacceptable Waste.

Indemnización. Cliente acuerda indemnizar, mantener inmune, y defender Republic Services, Inc., sus subsidiarios, compañías, divisiones, empleados, oficiales y directores contra de cualquiera y de todas responsabilidades, demandas, penas, pérdidas, juicios, pleitos y los costos incidente además, incluyendo costos de defensa, de acuerdo judicial, y de honorarios razonables del abogado, que pueden ser incurridos en, o como resultado de, la muerte o herida personal a cualquier persona, o daños a cualquier característica, propiedad, contaminación de la tierra o efectos ilícitos en esta Facilidad, causado entero o en parte por el cliente, sus empleados, o sus subcontratistas en botar basura en esta Facilidad. En el caso que el Cliente entrega, bota, basura (según lo determinado por Republic) en este Establecimiento basura inaceptable en los reglamentos de este Establecimiento, el Cliente se compromete asumir todos los costos y obligaciones con el retiro y/o la resolución de cualquier dano(s) causado por la entrega de tal basura inaceptable.



NON-HAZARDOUS WASTE MANIFEST

MANIFEST # 12093

GENERATOR INFORMATION

Generator Name: Tronox LLC
Address: P.O. Box 55
City: Henderson County: Clark
State: NV Zip: 89009

Site Location (if different): 560 W. Lake Mead
Henderson, NV 89015 (702) 592-7727

CUSTOMER/BILLING INFORMATION

Billing Name: NGE LLC c/o Northgate Environment Management
Address: 300 Frank Ogawa Plaza, Ste 510
City: Oakland County: Alameda
State: CA Zip: 94612

Table with 5 columns: Republic Services Approval #, Description of Waste, Volume/Weight, Expiration Date, Container Type. Row 1: 38251011244, Soil for disposal, 34.63 + N, 12-31-2011, Tractor with Dump Trailer(s).

*Attach Additional Sheet if necessary

I hereby certify that the above-described materials are non-hazardous wastes as defined by 40 CFR 261 or any applicable state law. Further, that the above named materials are properly classified, described, packaged, marked and labeled, and are in proper condition for transportation according to the applicable regulations of the Department of Transportation.

Susan Crowley
Generator/Authorized Agent Name Signature Date Shipped

TRANSPORTER INFORMATION

Transporter Name: Las Vegas Paving DOT # 191949
Address: 4420 S. Decatur Truck Number: 241
Las Vegas, NV 89103 Phone Number: (702) 353-4355

I certify no hazardous waste or other regulated substance was knowingly introduced to the waste while in my custody. The waste transported in this vehicle is the waste identified above, to the best of my knowledge.

Ken JACKSON
Name of Authorized Agent Signature Date Delivered 10-7-2010

DISPOSAL SITE INFORMATION

Site Name: Apex Regional Landfill Phone No. (702) 599-5920
Address: 13550 U.S. Hwy 93 Las Vegas, NV

I hereby acknowledge receipt of the above described materials
JASON CARTER
Name (Print or Type) Signature Date Received 10/7/10

81 Environmental Tech
13550 N Highway 93
Las Vegas, NV 89165

Ticket Type: INBOUND INVOICE

Ticket Number: 2005
Date: 10/07/2010
Time In: 8:17 pm
Time Out: 8:41 pm

Customer: 001011 - NGE, LLC c/o Northgate Environ Mgmt

Vehicle/Container: 76811P
Contract: Northgate Env. On Site Soils 3825 11
Comment: 3825 10 11244

Gross Weight: 120,240 LB Manual In
Tare Weight: 54,040 LB Manual Out
Net Weight: 66200 LB
Net Tons: 33.10

BOL: 12092

Origin	Yards	Material	Billing	Quantity
Not Applicable	0.00 YD	SW CONTAMINATED SOIL	33.10	TN

Driver: 

Weighmaster: 

CARTERJ

Indemnification. Customer agrees, by signature above, to indemnify, hold harmless, and defend Republic Services, Inc., its subsidiaries, affiliates, employees, officers and directors from and against any and all liabilities, claims, penalties, forfeitures, suits and the costs and expenses incident thereto, including costs of defense, settlement, and reasonable attorney's fees, which may be incurred, as a result of death or injuries to any person, or damage to any property, contamination of or adverse effects on the environment, caused in whole or in part by the Customer, its employees, or subcontractors in disposing waste at this Facility. In the event Customer delivers Unacceptable Waste (as determined by Republic) Customer agrees to assume all expenses and obligations with the removal and/or resolution of any effects caused by the delivery of such Unacceptable Waste.

Indemnización. Cliente acuerda indemnizar, mantener inmune, y defender Republic Services, Inc., sus subsidiarios, compañías, divisiones, empleados, oficiales y directores contra de cualquiera y de todas responsabilidades, demandas, penas, pérdidas, juicios, pleitos y los costos incidente además, incluyendo costos de defensa, de acuerdo judicial, y de honorarios razonables del abogado, que pueden ser incurridos en, o como resultado de, la muerte o herida personal a cualquier persona, o daños a cualquier característica, propiedad, contaminación de la tierra o efectos ilícitos en esta Facilidad, causado entero o en parte por el cliente, sus empleados, o sus subcontratistas en botar basura en esta Facilidad. En el caso que el Cliente entrega, bota, basura (según lo determinado por Republic) en este Establecimiento basura inaceptable en los reglamentos de este Establecimiento, el Cliente se compromete asumir todos los costos y obligaciones con el retiro y/o la resolución de cualquier dano(s) causado por la entrega de tal basura inaceptable.



NON-HAZARDOUS WASTE MANIFEST

MANIFEST # 12092

GENERATOR INFORMATION

Generator Name: Tronox LLC
Address: P.O. Box 55
City: Henderson County: Clark
State: NV Zip: 89009
Site Location (if different): 560 W. Lake Mead
Henderson, NV 89015 (702) 592-7727

CUSTOMER/BILLING INFORMATION

Billing Name: NGE LLC c/o Northgate Environment Management
Address: 300 Frank Ogawa Plaza, Ste 510
City: Oakland County: Alameda
State: CA Zip: 94612

Table with 5 columns: Republic Services Approval #, Description of Waste, Volume/Weight, Expiration Date, Container Type. Row 1: 38251011244, Soil for disposal, 33.10 TN, 12-31-2011, Tractor with Dump Trailer(s). Row 2: RZ- #

*Attach Additional Sheet if necessary

I hereby certify that the above-described materials are non-hazardous wastes as defined by 40 CFR 261 or any applicable state law. Further, that the above named materials are properly classified, described, packaged, marked and labeled, and are in proper condition for transportation according to the applicable regulations of the Department of Transportation.

Susan Crowley
Generator/Authorized Agent Name Signature Date Shipped

TRANSPORTER INFORMATION

Transporter Name: Las Vegas Paving DOT # 191949
Address: 4420 S. Decatur Truck Number: 242
Las Vegas, NV 89103 Phone Number: (702) 353-4355

I certify no hazardous waste or other regulated substance was knowingly introduced to the waste while in my custody. The waste transported in this vehicle is the waste identified above, to the best of my knowledge.

Maise Hefferon Mike Hefferon
Name of Authorized Agent Signature Date Delivered 10-7-10

DISPOSAL SITE INFORMATION

Site Name: Apex Regional Landfill Phone No. (702) 599-5920
Address: 13550 U.S. Hwy 93 Las Vegas, NV

I hereby acknowledge receipt of the above described materials
Name (Print or Type) Signature Date Received 10/7/10

81 Environmental Tech
13550 N Highway 93
Las Vegas, NV 89165

Ticket Type: INBOUND INVOICE

Ticket Number: 2006
Date: 10/07/2010
Time In: 8:28 pm
Time Out: 8:52 pm

Customer: 001011 - NGE, LLC c/o Northgate Environ Mgmt

Vehicle/Container: 68263P
Contract: Northgate Env. On Site Soils 3825 11
Comment: 3825 10 11244

Gross Weight: 117,040 LB Manual In
Tare Weight: 53,580 LB Manual Out
Net Weight: 63460 LB
Net Tons: 31.73

BOL: 12094

Origin	Yards	Material	Billing	Quantity
Not Applicable	0.00 YD	SW CONTAMINATED SOIL	31.73	TN

Driver: _____

Weighmaster: _____

IN - SMITHJ OUT - CARTERJ

Indemnification. Customer agrees, by signature above, to indemnify, hold harmless, and defend Republic Services, Inc., its subsidiaries, affiliates, employees, officers and directors from and against any and all liabilities, claims, penalties, forfeitures, suits and the costs and expenses incident thereto, including costs of defense, settlement, and reasonable attorney's fees, which may be incurred, as a result of death or injuries to any person, or damage to any property, contamination of or adverse effects on the environment, caused in whole or in part by the Customer, its employees, or subcontractors in disposing waste at this Facility. In the event Customer delivers Unacceptable Waste (as determined by Republic) Customer agrees to assume all expenses and obligations with the removal and/or resolution of any effects caused by the delivery of such Unacceptable Waste.

Indemnización. Cliente acuerda indemnizar, mantener inmune, y defender Republic Services, Inc., sus subsidiarios, compañías, divisiones, empleados, oficiales y directores contra de cualquiera y de todas responsabilidades, demandas, penas, pérdidas, juicios, pleitos y los costos incidente además, incluyendo costos de defensa, de acuerdo judicial, y de honorarios razonables del abogado, que pueden ser incurridos en, o como resultado de, la muerte o herida personal a cualquier persona, o daños a cualquier característica, propiedad, contaminación de la tierra o efectos ilícitos en esta Facilidad, causado entero o en parte por el cliente, sus empleados, o sus subcontratistas en botar basura en esta Facilidad. En el caso que el Cliente entrega, bota, basura (según lo determinado por Republic) en este Establecimiento basura inaceptable en los reglamentos de este Establecimiento, el Cliente se compromete asumir todos los costos y obligaciones con el retiro y/o la resolución de cualquier dano(s) causado por la entrega de tal basura inaceptable.



NON-HAZARDOUS WASTE MANIFEST

MANIFEST # 12094

GENERATOR INFORMATION

Generator Name: Tronox LLC
Address: P.O. Box 55
City: Henderson County: Clark
State: NV Zip: 89009
Site Location (if different): 560 W. Lake Mead
Henderson, NV 89015 (702) 592-7727

CUSTOMER/BILLING INFORMATION

Billing Name: NGE LLC c/o Northgate Environment Management
Address: 300 Frank Ogawa Plaza, Ste 510
City: Oakland County: Alameda
State: CA Zip: 94612

Table with 5 columns: Republic Services Approval #, Description of Waste, Volume/Weight, Expiration Date, Container Type. Row 1: 38251011244, Soil for disposal, 31.73 TN, 12-31-2011, Tractor with Dump Trailer(s).

*Attach Additional Sheet if necessary

I hereby certify that the above-described materials are non-hazardous wastes as defined by 40 CFR 261 or any applicable state law. Further, that the above named materials are properly classified, described, packaged, marked and labeled, and are in proper condition for transportation according to the applicable regulations of the Department of Transportation.

Susan Crowley
Generator/Authorized Agent Name Signature Date Shipped

TRANSPORTER INFORMATION

Transporter Name: Las Vegas Paving DOT # 191949
Address: 4420 S. Decatur Truck Number: 2711
Las Vegas, NV 89103 Phone Number: (702) 353-4355

I certify no hazardous waste or other regulated substance was knowingly introduced to the waste while in my custody. The waste transported in this vehicle is the waste identified above, to the best of my knowledge.

STEVE HAYES
Name of Authorized Agent Signature Date Delivered 10-7-10

DISPOSAL SITE INFORMATION

Site Name: Apex Regional Landfill Phone No. (702) 599-5920
Address: 13550 U.S. Hwy 93 Las Vegas, NV

I hereby acknowledge receipt of the above described materials
JASON CARTER
Name (Print or Type) Signature Date Received 10/7/10

81 Environmental Tech
13550 N Highway 93
Las Vegas, NV 89165

Ticket Type: INBOUND INVOICE

Ticket Number: 2007
Date: 10/07/2010
Time In: 8:32 pm
Time Out: 8:57 pm

Customer: 001011 - NGE, LLC c/o Northgate Environ Mgmt

Vehicle/Container: 35902A
Contract: Northgate Env. On Site Soils 3825 11
Comment: 3825 10 11244

Gross Weight: 125,540 LB Manual In
Tare Weight: 60,080 LB Manual Out
Net Weight: 65460 LB
Net Tons: 32.73

BOL: 12095

Origin	Yards	Material	Billing Quantity
Not Applicable	0.00 YD	SW CONTAMINATED SOIL	32.73 TN

Driver: 

Weighmaster: 

CARTERJ

Indemnification. Customer agrees, by signature above, to indemnify, hold harmless, and defend Republic Services, Inc., its subsidiaries, affiliates, employees, officers and directors from and against any and all liabilities, claims, penalties, forfeitures, suits and the costs and expenses incident thereto, including costs of defense, settlement, and reasonable attorney's fees, which may be incurred, as a result of death or injuries to any person, or damage to any property, contamination of or adverse effects on the environment, caused in whole or in part by the Customer, its employees, or subcontractors in disposing waste at this Facility. In the event Customer delivers Unacceptable Waste (as determined by Republic) Customer agrees to assume all expenses and obligations with the removal and/or resolution of any effects caused by the delivery of such Unacceptable Waste.

Indemnización. Cliente acuerda indemnizar, mantener inmune, y defender Republic Services, Inc., sus subsidiarios, compañías, divisiones, empleados, oficiales y directores contra de cualquiera y de todas responsabilidades, demandas, penas, pérdidas, juicios, pleitos y los costos incidente además, incluyendo costos de defensa, de acuerdo judicial, y de honorarios razonables del abogado, que pueden ser incurridos en, o como resultado de, la muerte o herida personal a cualquier persona, o daños a cualquier característica, propiedad, contaminación de la tierra o efectos ilícitos en esta Facilidad, causado entero o en parte por el cliente, sus empleados, o sus subcontratistas en botar basura en esta Facilidad. En el caso que el Cliente entrega, bota, basura (según lo determinado por Republic) en este Establecimiento basura inaceptable en los reglamentos de este Establecimiento, el Cliente se compromete asumir todos los costos y obligaciones con el retiro y/o la resolución de cualquier dano(s) causado por la entrega de tal basura inaceptable.



NON-HAZARDOUS WASTE MANIFEST

MANIFEST # 12095

GENERATOR INFORMATION

Generator Name: Tronox LLC

Address: P.O. Box 55

City: Henderson County: Clark

State: NV Zip: 89009

Site Location (if different): 560 W. Lake Mead

Henderson, NV 89015 (702) 592-7727

CUSTOMER/BILLING INFORMATION

Billing Name: NGE LLC c/o Northgate Environment Management

Address: 300 Frank Ogawa Plaza, Ste 510

City: Oakland County: Alameda

State: CA Zip: 94612

Republic Services Approval #	Description of Waste	Volume/Weight	Expiration Date	Container Type
38251011244	Soil for disposal	32.73 TN	12-31-2011	Tractor with Dump Trailer(s)
	RZ- #			

*Attach Additional Sheet if necessary

I hereby certify that the above-described materials are non-hazardous wastes as defined by 40 CFR 261 or any applicable state law. Further, that the above named materials are properly classified, described, packaged, marked and labeled, and are in proper condition for transportation according to the applicable regulations of the Department of Transportation.

Susan Crowley

Generator/Authorized Agent Name

Signature

Date Shipped

TRANSPORTER INFORMATION

Transporter Name: Las Vegas Paving

DOT # 191949

Address: 4420 S. Decatur

Truck Number: 071

Las Vegas, NV 89103

Phone Number: (702) 353-4355

I certify no hazardous waste or other regulated substance was knowingly introduced to the waste while in my custody. The waste transported in this vehicle is the waste identified above, to the best of my knowledge.

Name of Authorized Agent

Signature

Date Delivered 10-7-10

DISPOSAL SITE INFORMATION

Site Name: Apex Regional Landfill

Phone No. (702) 599-5920

Address: 13550 U.S. Hwy 93 Las Vegas, NV

I hereby acknowledge receipt of the above described materials

Name (Print or Type) JASON CARTER

Signature

Date Received 10/7/10

81 Environmental Tech
13550 N Highway 93
Las Vegas, NV 89165

Ticket Type: INBOUND INVOICE

Ticket Number: 2008
Date: 10/07/2010
Time In: 9:25 pm
Time Out: 9:25 pm

Customer: 001011 - NGE, LLC c/o Northgate Environ Mgmt

Vehicle/Container: 44165A
Contract: Northgate Env. On Site Soils 3825 11
Comment: 3825 10 11244

Gross Weight: 123,540 LB Manual In
Tare Weight: 49,660 LB Manual Out
Net Weight: 73880 LB
Net Tons: 36.94

BOL: 12096

Origin	Yards	Material	Billing	Quantity
Not Applicable	0.00 YD	SW CONTAMINATED SOIL	36.94	TN

Driver: 

Weighmaster: 
CARTERJ

Indemnification. Customer agrees, by signature above, to indemnify, hold harmless, and defend Republic Services, Inc., its subsidiaries, affiliates, employees, officers and directors from and against any and all liabilities, claims, penalties, forfeitures, suits and the costs and expenses incident thereto, including costs of defense, settlement, and reasonable attorney's fees, which may be incurred, as a result of death or injuries to any person, or damage to any property, contamination of or adverse effects on the environment, caused in whole or in part by the Customer, its employees, or subcontractors in disposing waste at this Facility. In the event Customer delivers Unacceptable Waste (as determined by Republic) Customer agrees to assume all expenses and obligations with the removal and/or resolution of any effects caused by the delivery of such Unacceptable Waste.

Indemnización. Cliente acuerda indemnizar, mantener inmune, y defender Republic Services, Inc., sus subsidiarios, compañías, divisiones, empleados, oficiales y directores contra de cualquiera y de todas responsabilidades, demandas, penas, pérdidas, juicios, pleitos y los costos incidente además, incluyendo costos de defensa, de acuerdo judicial, y de honorarios razonables del abogado, que pueden ser incurridos en, o como resultado de, la muerte o herida personal a cualquier persona, o daños a cualquier característica, propiedad, contaminación de la tierra o efectos ilícitos en esta Facilidad, causado entero o en parte por el cliente, sus empleados, o sus subcontratistas en botar basura en esta Facilidad. En el caso que el Cliente entrega, bota, basura (según lo determinado por Republic) en este Establecimiento basura inaceptable en los reglamentos de este Establecimiento, el Cliente se compromete asumir todos los costos y obligaciones con el retiro y/o la resolución de cualquier dano(s) causado por la entrega de tal basura inaceptable.



NON-HAZARDOUS WASTE MANIFEST

MANIFEST # 12096

GENERATOR INFORMATION

Generator Name: Tronox LLC

Address: P.O. Box 55

City: Henderson County: Clark

State: NV Zip: 89009

Site Location (if different): 560 W. Lake Mead
Henderson, NV 89015 (702) 592-7727

CUSTOMER/BILLING INFORMATION

Billing Name: NGE LLC c/o Northgate Environment Management

Address: 300 Frank Ogawa Plaza, Ste 510

City: Oakland County: Alameda

State: CA Zip: 94612

Table with 5 columns: Republic Services Approval #, Description of Waste, Volume/Weight, Expiration Date, Container Type. Row 1: 38251011244, Soil for disposal, 36,947N, 12-31-2011, Tractor with Dump Trailer(s).

*Attach Additional Sheet if necessary

I hereby certify that the above-described materials are non-hazardous wastes as defined by 40 CFR 261 or any applicable state law. Further, that the above named materials are properly classified, described, packaged, marked and labeled, and are in proper condition for transportation according to the applicable regulations of the Department of Transportation.

Susan Crowley (Signature)
Generator/Authorized Agent Name Signature Date Shipped

TRANSPORTER INFORMATION

Transporter Name: Las Vegas Paving

DOT # 191949

Address: 4420 S. Decatur

Truck Number: 10001

Las Vegas, NV 89103

Phone Number: (702) 353-4355

I certify no hazardous waste or other regulated substance was knowingly introduced to the waste while in my custody. The waste transported in this vehicle is the waste identified above, to the best of my knowledge.

R. Ammer (Signature)
Name of Authorized Agent Signature Date Delivered 10-7-10

DISPOSAL SITE INFORMATION

Site Name: Apex Regional Landfill

Phone No. (702) 599-5920

Address: 13550 U.S. Hwy 93 Las Vegas, NV

I hereby acknowledge receipt of the above described materials

JASON CARTER (Signature)
Name (Print or Type) Signature Date Received 10/7/10

81 Environmental Tech
13550 N Highway 93
Las Vegas, NV 89165

Ticket Type: INBOUND INVOICE

Ticket Number: 2009
Date: 10/07/2010
Time In: 9:08 pm
Time Out: 9:32 pm

Customer: 001011 - NGE, LLC c/o Northgate Environ Mgmt

Vehicle/Container: 86113P
Contract: Northgate Env. On Site Soils 3825 11
Comment: 3825 10 11244

Gross Weight: 134,440 LB Manual In
Tare Weight: 55,660 LB Manual Out
Net Weight: 78780 LB
Net Tons: 39.39

BOL: 12097

Origin	Yards	Material	Billing Quantity
Not Applicable	0.00 YD	SW CONTAMINATED SOIL	39.39 TN

Driver: _____



Weighmaster: _____



CARTERJ

Indemnification. Customer agrees, by signature above, to indemnify, hold harmless, and defend Republic Services, Inc., its subsidiaries, affiliates, employees, officers and directors from and against any and all liabilities, claims, penalties, forfeitures, suits and the costs and expenses incident thereto, including costs of defense, settlement, and reasonable attorney's fees, which may be incurred, as a result of death or injuries to any person, or damage to any property, contamination of or adverse effects on the environment, caused in whole or in part by the Customer, its employees, or subcontractors in disposing waste at this Facility. In the event Customer delivers Unacceptable Waste (as determined by Republic) Customer agrees to assume all expenses and obligations with the removal and/or resolution of any effects caused by the delivery of such Unacceptable Waste.

Indemnización. Cliente acuerda indemnizar, mantener inmune, y defender Republic Services, Inc., sus subsidiarios, compañías, divisiones, empleados, oficiales y directores contra de cualquiera y de todas responsabilidades, demandas, penas, pérdidas, juicios, pleitos y los costos incidente además, incluyendo costos de defensa, de acuerdo judicial, y de honorarios razonables del abogado, que pueden ser incurridos en, o como resultado de, la muerte o herida personal a cualquier persona, o daños a cualquier característica, propiedad, contaminación de la tierra o efectos ilícitos en esta Facilidad, causado entero o en parte por el cliente, sus empleados, o sus subcontratistas en botar basura en esta Facilidad. En el caso que el Cliente entrega, bota, basura (según lo determinado por Republic) en este Establecimiento basura inaceptable en los reglamentos de este Establecimiento, el Cliente se compromete asumir todos los costos y obligaciones con el retiro y/o la resolución de cualquier dano(s) causado por la entrega de tal basura inaceptable.



NON-HAZARDOUS WASTE MANIFEST

MANIFEST # 12097

GENERATOR INFORMATION

Generator Name: Tronox LLC

Address: P.O. Box 55

City: Henderson County: Clark

State: NV Zip: 89009

Site Location (if different): 560 W. Lake Mead

Henderson, NV 89015 (702) 592-7727

CUSTOMER/BILLING INFORMATION

Billing Name: NGE LLC c/o Northgate Environment Management

Address: 300 Frank Ogawa Plaza, Ste 510

City: Oakland County: Alameda

State: CA Zip: 94612

Table with 5 columns: Republic Services Approval #, Description of Waste, Volume/Weight, Expiration Date, Container Type. Row 1: 38251011244, Soil for disposal, 39.39 TN, 12-31-2011, Tractor with Dump Trailer(s). Row 2: RZ- #

*Attach Additional Sheet if necessary

I hereby certify that the above-described materials are non-hazardous wastes as defined by 40 CFR 261 or any applicable state law. Further, that the above named materials are properly classified, described, packaged, marked and labeled, and are in proper condition for transportation according to the applicable regulations of the Department of Transportation.

Susan Crowley (Signature) Date Shipped

TRANSPORTER INFORMATION

Transporter Name: Las Vegas Paving

DOT # 191949

Address: 4420 S. Decatur

Truck Number: 1K0019/M

Las Vegas, NV 89103

Phone Number: (702) 353-4355

I certify no hazardous waste or other regulated substance was knowingly introduced to the waste while in my custody. The waste transported in this vehicle is the waste identified above, to the best of my knowledge.

ALBERTO (Signature) Date Delivered Oct 7, 2010

DISPOSAL SITE INFORMATION

Site Name: Apex Regional Landfill

Phone No. (702) 599-5920

Address: 13550 U.S. Hwy 93 Las Vegas, NV

I hereby acknowledge receipt of the above described materials

JASON CARTER (Signature) Date Received 10/7/10

81 Environmental Tech
13550 N Highway 93
Las Vegas, NV 89165

Ticket Type: INBOUND INVOICE

Ticket Number: 2010
Date: 10/07/2010
Time In: 9:12 pm
Time Out: 9:36 pm

Customer: 001011 - NGE, LLC c/o Northgate Environ Mgmt

Vehicle/Container: 85887P
Contract: Northgate Env. On Site Soils 3825 11
Comment: 3825 10 11244

Gross Weight: 126,180 LB Manual In
Tare Weight: 51,920 LB Manual Out
Net Weight: 74260 LB
Net Tons: 37.13

BOL: 12098

Origin	Yards	Material	Billing	Quantity
Not Applicable	0.00 YD	SW CONTAMINATED SOIL	37.13	TN

Driver: _____

Weighmaster: _____

CARTERJ

Indemnification. Customer agrees, by signature above, to indemnify, hold harmless, and defend Republic Services, Inc., its subsidiaries, affiliates, employees, officers and directors from and against any and all liabilities, claims, penalties, forfeitures, suits and the costs and expenses incident thereto, including costs of defense, settlement, and reasonable attorney's fees, which may be incurred, as a result of death or injuries to any person, or damage to any property, contamination of or adverse effects on the environment, caused in whole or in part by the Customer, its employees, or subcontractors in disposing waste at this Facility. In the event Customer delivers Unacceptable Waste (as determined by Republic) Customer agrees to assume all expenses and obligations with the removal and/or resolution of any effects caused by the delivery of such Unacceptable Waste.

Indemnización. Cliente acuerda indemnizar, mantener inmune, y defender Republic Services, Inc., sus subsidiarios, compañías, divisiones, empleados, oficiales y directores contra de cualquiera y de todas responsabilidades, demandas, penas, pérdidas, juicios, pleitos y los costos incidente además, incluyendo costos de defensa, de acuerdo judicial, y de honorarios razonables del abogado, que pueden ser incurridos en, o como resultado de, la muerte o herida personal a cualquier persona, o daños a cualquier característica, propiedad, contaminación de la tierra o efectos ilícitos en esta Facilidad, causado entero o en parte por el cliente, sus empleados, o sus subcontratistas en botar basura en esta Facilidad. En el caso que el Cliente entrega, bota, basura (según lo determinado por Republic) en este Establecimiento basura inaceptable en los reglamentos de este Establecimiento, el Cliente se compromete asumir todos los costos y obligaciones con el retiro y/o la resolución de cualquier dano(s) causado por la entrega de tal basura inaceptable.



NON-HAZARDOUS WASTE MANIFEST

MANIFEST # 12098

GENERATOR INFORMATION

Generator Name: Tronox LLC

Address: P.O. Box 55

City: Henderson County: Clark

State: NV Zip: 89009

Site Location (if different): 560 W. Lake Mead

Henderson, NV 89015 (702) 592-7727

CUSTOMER/BILLING INFORMATION

Billing Name: NGE LLC c/o Northgate Environment Management

Address: 300 Frank Ogawa Plaza, Ste 510

City: Oakland County: Alameda

State: CA Zip: 94612

Republic Services Approval #	Description of Waste	Volume/Weight	Expiration Date	Container Type
38251011244	Soil for disposal	37.13 TN	12-31-2011	Tractor with Dump Trailer(s)
	RZ- #			

*Attach Additional Sheet if necessary

I hereby certify that the above-described materials are non-hazardous wastes as defined by 40 CFR 261 or any applicable state law. Further, that the above named materials are properly classified, described, packaged, marked and labeled, and are in proper condition for transportation according to the applicable regulations of the Department of Transportation.

Susan Crowley

Susan Crowley

Generator/Authorized Agent Name

Signature

Date Shipped

TRANSPORTER INFORMATION

Transporter Name: Las Vegas Paving

DOT # 191949

Address: 4420 S. Decatur

Truck Number: R01

Las Vegas, NV 89103

Phone Number: (702) 353-4355

I certify no hazardous waste or other regulated substance was knowingly introduced to the waste while in my custody. The waste transported in this vehicle is the waste identified above, to the best of my knowledge.

Robert Jones

Name of Authorized Agent

Signature

Date Delivered

10/7/10

DISPOSAL SITE INFORMATION

Site Name: Apex Regional Landfill

Phone No. (702) 599-5920

Address: 13550 U.S. Hwy 93 Las Vegas, NV

I hereby acknowledge receipt of the above described materials

JASON CARTER

Name (Print or Type)

Signature

Date Received

10/7/10

15500 Highway 50
Las Vegas, NV 89165

Date: 10/07/2010
Time In: 9:21 pm
Time Out: 9:41 pm

2011

Customer: 001011 - NGE, LLC c/o Northgate Environ Mgmt

Vehicle/Container: 44564A
Contract: Northgate Env. On Site Soils 3825 11
Comment: 3825 10 11244

Gross Weight: 130,820 LB Manual In
Tare Weight: 49,520 LB Manual Out
Net Weight: 81,300 LB
Net Tons: 40.65

BOL: 12100

Origin	Yards	Material	Billing Quantity
Not Applicable	0.00 YD	SW CONTAMINATED SOIL	40.65 TN

Driver: _____

Weighmaster: _____

CARTERJ

Indemnification. Customer agrees, by signature above, to indemnify, hold harmless, and defend Republic Services, Inc., its subsidiaries, affiliates, employees, officers and directors from and against any and all liabilities, claims, penalties, forfeitures, suits and the costs and expenses incident thereto, including costs of defense, settlement, and reasonable attorney's fees, which may be incurred, as a result of death or injuries to any person, or damage to any property, contamination of or adverse effects on the environment, caused in whole or in part by the Customer, its employees, or subcontractors in disposing waste at this Facility. In the event Customer delivers Unacceptable Waste (as determined by Republic) Customer agrees to assume all expenses and obligations with the removal and/or resolution of any effects caused by the delivery of such Unacceptable Waste.

Indemnización. Cliente acuerda indemnizar, mantener inmune, y defender Republic Services, Inc., sus subsidiarios, compañías, divisiones, empleados, oficiales y directores contra de cualquiera y de todas responsabilidades, demandas, penas, pérdidas, juicios, pleitos y los costos incidente además, incluyendo costos de defensa, de acuerdo judicial, y de honorarios razonables del abogado, que pueden ser incurridos en, o como resultado de, la muerte o herida personal a cualquier persona, o daños a cualquier característica, propiedad, contaminación de la tierra o efectos ilícitos en esta Facilidad, causado entero o en parte por el cliente, sus empleados, o sus subcontratistas en botar basura en esta Facilidad. En el caso que el Cliente entrega, bota, basura (según lo determinado por Republic) en este Establecimiento basura inaceptable en los reglamentos de este Establecimiento, el Cliente se compromete asumir todos los costos y obligaciones con el retiro y/o la resolución de cualquier dano(s) causado por la entrega de tal basura inaceptable.



NON-HAZARDOUS WASTE MANIFEST

MANIFEST # 12100

GENERATOR INFORMATION

Generator Name: Tronox LLCAddress: P.O. Box 55City: Henderson County: ClarkState: NV Zip: 89009Site Location (if different): 560 W. Lake Mead
Henderson, NV 89015 (702) 592-7727

CUSTOMER/BILLING INFORMATION

Billing Name: NGE LLC c/o Northgate Environment ManagementAddress: 300 Frank Ogawa Plaza, Ste 510City: Oakland County: AlamedaState: CA Zip: 94612

Republic Services Approval #	Description of Waste	Volume/Weight	Expiration Date	Container Type
38251011244	Soil for disposal	40.65 TN	12-31-2011	Tractor with Dump Trailer(s)
	RZ- _____ # _____			

*Attach Additional Sheet if necessary

I hereby certify that the above-described materials are non-hazardous wastes as defined by 40 CFR 261 or any applicable state law. Further, that the above named materials are properly classified, described, packaged, marked and labeled, and are in proper condition for transportation according to the applicable regulations of the Department of Transportation.

Susan Crowley *Susan Crowley* _____
 Generator/Authorized Agent Name Signature Date Shipped

TRANSPORTER INFORMATION

Transporter Name: Las Vegas PavingDOT # 191949Address: 4420 S. DecaturTruck Number: 1003Las Vegas, NV 89103Phone Number: (702) 353-4355

I certify no hazardous waste or other regulated substance was knowingly introduced to the waste while in my custody. The waste transported in this vehicle is the waste identified above, to the best of my knowledge.

CCBV *CCBV* _____ 10/07/10
 Name of Authorized Agent Signature Date Delivered

DISPOSAL SITE INFORMATION

Site Name: Apex Regional LandfillPhone No. (702) 599-5920Address: 13550 U.S. Hwy 93 Las Vegas, NV

I hereby acknowledge receipt of the above described materials
JASON CARTEL *J* _____ 10/7/10
 Name (Print or Type) Signature Date Received

81 Environmental Tech
13550 N Highway 93
Las Vegas, NV 89165

Ticket Type: INBOUND INVOICE

Ticket Number: 2012
Date: 10/07/2010
Time In: 9:22 pm
Time Out: 9:47 pm

Customer: 001011 - NGE, LLC c/o Northgate Environ Mgmt

Vehicle/Container: 44166A
Contract: Northgate Env. On Site Soils 3825 11
Comment: 3825 10 11244

Gross Weight: 136,740 LB Manual In
Tare Weight: 57,460 LB Manual Out
Net Weight: 79,280 LB
Net Tons: 39.64

BOL: 12099

Origin	Yards	Material	Billing	Quantity
Not Applicable	0.00 YD	SW CONTAMINATED SOIL	39.64	TN

Driver: _____

Weighmaster: _____

CARTERJ

Indemnification. Customer agrees, by signature above, to indemnify, hold harmless, and defend Republic Services, Inc., its subsidiaries, affiliates, employees, officers and directors from and against any and all liabilities, claims, penalties, forfeitures, suits and the costs and expenses incident thereto, including costs of defense, settlement, and reasonable attorney's fees, which may be incurred, as a result of death or injuries to any person, or damage to any property, contamination of or adverse effects on the environment, caused in whole or in part by the Customer, its employees, or subcontractors in disposing waste at this Facility. In the event Customer delivers Unacceptable Waste (as determined by Republic) Customer agrees to assume all expenses and obligations with the removal and/or resolution of any effects caused by the delivery of such Unacceptable Waste.

Indemnización. Cliente acuerda indemnizar, mantener inmune, y defender Republic Services, Inc., sus subsidiarios, compañías, divisiones, empleados, oficiales y directores contra de cualquiera y de todas responsabilidades, demandas, penas, pérdidas, juicios, pleitos y los costos incidente además, incluyendo costos de defensa, de acuerdo judicial, y de honorarios razonables del abogado, que pueden ser incurridos en, o como resultado de, la muerte o herida personal a cualquier persona, o daños a cualquier característica, propiedad, contaminación de la tierra o efectos ilícitos en esta Facilidad, causado entero o en parte por el cliente, sus empleados, o sus subcontratistas en botar basura en esta Facilidad. En el caso que el Cliente entrega, bota, basura (según lo determinado por Republic) en este Establecimiento basura inaceptable en los reglamentos de este Establecimiento, el Cliente se compromete asumir todos los costos y obligaciones con el retiro y/o la resolución de cualquier dano(s) causado por la entrega de tal basura inaceptable.



NON-HAZARDOUS WASTE MANIFEST

MANIFEST # 12099

GENERATOR INFORMATION

Generator Name: Tronox LLC

Address: P.O. Box 55

City: Henderson County: Clark

State: NV Zip: 89009

Site Location (if different): 560 W. Lake Mead

Henderson, NV 89015 (702) 592-7727

CUSTOMER/BILLING INFORMATION

Billing Name: NGE LLC c/o Northgate Environment Management

Address: 300 Frank Ogawa Plaza, Ste 510

City: Oakland County: Alameda

State: CA Zip: 94612

Republic Services Approval #	Description of Waste	Volume/Weight	Expiration Date	Container Type
38251011244	Soil for disposal	39.64 TN	12-31-2011	Tractor with Dump Trailer(s)
	RZ- _____ # _____			

*Attach Additional Sheet if necessary

I hereby certify that the above-described materials are non-hazardous wastes as defined by 40 CFR 261 or any applicable state law. Further, that the above named materials are properly classified, described, packaged, marked and labeled, and are in proper condition for transportation according to the applicable regulations of the Department of Transportation.

Susan Crowley
Generator/Authorized Agent Name

Susan Crowley
Signature

Date Shipped

TRANSPORTER INFORMATION

Transporter Name: Las Vegas Paving

DOT # 191949

Address: 4420 S. Decatur

Truck Number: K002

Las Vegas, NV 89103

Phone Number: (702) 353-4355

I certify no hazardous waste or other regulated substance was knowingly introduced to the waste while in my custody. The waste transported in this vehicle is the waste identified above, to the best of my knowledge.

Hugo Costello
Name of Authorized Agent

Hugo Costello
Signature

10-7-10
Date Delivered

DISPOSAL SITE INFORMATION

Site Name: Apex Regional Landfill

Phone No. (702) 599-5920

Address: 13550 U.S. Hwy 93 Las Vegas, NV

I hereby acknowledge receipt of the above described materials

JASON CARTER
Name (Print or Type)

Jason Carter
Signature

10/7/10
Date Received

81 Environmental Tech
13550 N Highway 93
Las Vegas, NV 89165

Ticket Type: INBOUND INVOICE

Ticket Number: 2013
Date: 10/07/2010
Time In: 9:30 pm
Time Out: 9:55 pm

Customer: 001011 - NGE, LLC c/o Northgate Environ Mgmt

Vehicle/Container: 192456
Contract: Northgate Env. On Site Soils 3825 11
Comment: 3825 10 11244

Gross Weight: 127,860 LB Manual In
Tare Weight: 53,360 LB Manual Out
Net Weight: 74500 LB
Net Tons: 37.25

BOL: 12101

Origin	Yards	Material	Billing	Quantity
Not Applicable	0.00 YD	SW CONTAMINATED SOIL	37.25	TN

Driver: _____

Weighmaster: _____

IN - CARTERJ OUT - SMITHJ

Indemnification. Customer agrees, by signature above, to indemnify, hold harmless, and defend Republic Services, Inc., its subsidiaries, affiliates, employees, officers and directors from and against any and all liabilities, claims, penalties, forfeitures, suits and the costs and expenses incident thereto, including costs of defense, settlement, and reasonable attorney's fees, which may be incurred, as a result of death or injuries to any person, or damage to any property, contamination of or adverse effects on the environment, caused in whole or in part by the Customer, its employees, or subcontractors in disposing waste at this Facility. In the event Customer delivers Unacceptable Waste (as determined by Republic) Customer agrees to assume all expenses and obligations with the removal and/or resolution of any effects caused by the delivery of such Unacceptable Waste.

Indemnización. Cliente acuerda indemnizar, mantener inmune, y defender Republic Services, Inc., sus subsidiarios, compañías, divisiones, empleados, oficiales y directores contra de cualquiera y de todas responsabilidades, demandas, penas, pérdidas, juicios, pleitos y los costos incidente además, incluyendo costos de defensa, de acuerdo judicial, y de honorarios razonables del abogado, que pueden ser incurridos en, o como resultado de, la muerte o herida personal a cualquier persona, o daños a cualquier característica, propiedad, contaminación de la tierra o efectos ilícitos en esta Facilidad, causado entero o en parte por el cliente, sus empleados, o sus subcontratistas en botar basura en esta Facilidad. En el caso que el Cliente entrega, bota, basura (según lo determinado por Republic) en este Establecimiento basura inaceptable en los reglamentos de este Establecimiento, el Cliente se compromete asumir todos los costos y obligaciones con el retiro y/o la resolución de cualquier dano(s) causado por la entrega de tal basura inaceptable.



NON-HAZARDOUS WASTE MANIFEST

MANIFEST # 12101

GENERATOR INFORMATION

Generator Name: Tronox LLC
Address: P.O. Box 55
City: Henderson County: Clark
State: NV Zip: 89009
Site Location (if different): 560 W. Lake Mead
Henderson, NV 89015 (702) 592-7727

CUSTOMER/BILLING INFORMATION

Billing Name: NGE LLC c/o Northgate Environment Management
Address: 300 Frank Ogawa Plaza, Ste 510
City: Oakland County: Alameda
State: CA Zip: 94612

Table with 5 columns: Republic Services Approval #, Description of Waste, Volume/Weight, Expiration Date, Container Type. Row 1: 38251011244, Soil for disposal, 37.25 TB, 12-31-2011, Tractor with Dump Trailer(s).

*Attach Additional Sheet if necessary

I hereby certify that the above-described materials are non-hazardous wastes as defined by 40 CFR 261 or any applicable state law. Further, that the above named materials are properly classified, described, packaged, marked and labeled, and are in proper condition for transportation according to the applicable regulations of the Department of Transportation.

Susan Crowley (Signature)
Generator/Authorized Agent Name Signature Date Shipped

TRANSPORTER INFORMATION

Transporter Name: Las Vegas Paving DOT # 191949
Address: 4420 S. Decatur Truck Number: 192456
Las Vegas, NV 89103 Phone Number: (702) 353-4355

I certify no hazardous waste or other regulated substance was knowingly introduced to the waste while in my custody. The waste transported in this vehicle is the waste identified above, to the best of my knowledge.

(Signature) (Signature) 10/7/10
Name of Authorized Agent Signature Date Delivered

DISPOSAL SITE INFORMATION

Site Name: Apex Regional Landfill Phone No. (702) 599-5920
Address: 13550 U.S. Hwy 93 Las Vegas, NV

I hereby acknowledge receipt of the above described materials
Name (Print or Type) Signature Date Received

81 Environmental Tech
13550 N Highway 93
Las Vegas, NV 89165

Ticket Type: INBOUND INVOICE

Ticket Number: 2014
Date: 10/07/2010
Time In: 9:33 pm
Time Out: 9:57 pm

Customer: 001011 - NGE, LLC c/o Northgate Environ Mgmt

Vehicle/Container: 192457
Contract: Northgate Env. On Site Soils 3825 11
Comment: 3825 10 11244

Gross Weight: 125,900 LB Manual In
Tare Weight: 53,800 LB Manual Out
Net Weight: 72100 LB
Net Tons: 36.05

BOL: 12102

Origin	Yards	Material	Billing	Quantity
Not Applicable	0.00 YD	SW CONTAMINATED SOIL	36.05	TN

Driver: 

Weighmaster: 

IN - CARTERJ OUT - SMITHJ

Indemnification. Customer agrees, by signature above, to indemnify, hold harmless, and defend Republic Services, Inc., its subsidiaries, affiliates, employees, officers and directors from and against any and all liabilities, claims, penalties, forfeitures, suits and the costs and expenses incident thereto, including costs of defense, settlement, and reasonable attorney's fees, which may be incurred, as a result of death or injuries to any person, or damage to any property, contamination of or adverse effects on the environment, caused in whole or in part by the Customer, its employees, or subcontractors in disposing waste at this Facility. In the event Customer delivers Unacceptable Waste (as determined by Republic) Customer agrees to assume all expenses and obligations with the removal and/or resolution of any effects caused by the delivery of such Unacceptable Waste.

Indemnización. Cliente acuerda indemnizar, mantener inmune, y defender Republic Services, Inc., sus subsidiarios, compañías, divisiones, empleados, oficiales y directores contra de cualquiera y de todas responsabilidades, demandas, penas, pérdidas, juicios, pleitos y los costos incidente además, incluyendo costos de defensa, de acuerdo judicial, y de honorarios razonables del abogado, que pueden ser incurridos en, o como resultado de, la muerte o herida personal a cualquier persona, o daños a cualquier característica, propiedad, contaminación de la tierra o efectos ilícitos en esta Facilidad, causado entero o en parte por el cliente, sus empleados, o sus subcontratistas en botar basura en esta Facilidad. En el caso que el Cliente entrega, bota, basura (según lo determinado por Republic) en este Establecimiento basura inaceptable en los reglamentos de este Establecimiento, el Cliente se compromete asumir todos los costos y obligaciones con el retiro y/o la resolución de cualquier dano(s) causado por la entrega de tal basura inaceptable.



NON-HAZARDOUS WASTE MANIFEST

MANIFEST # 12102

GENERATOR INFORMATION

Generator Name: Tronox LLC

Address: P.O. Box 55

City: Henderson County: Clark

State: NV Zip: 89009

Site Location (if different): 560 W. Lake Mead

Henderson, NV 89015 (702) 592-7727

CUSTOMER/BILLING INFORMATION

Billing Name: NGE LLC c/o Northgate Environment Management

Address: 300 Frank Ogawa Plaza, Ste 510

City: Oakland County: Alameda

State: CA Zip: 94612

Republic Services Approval #	Description of Waste	Volume/Weight	Expiration Date	Container Type
38251011244	Soil for disposal		12-31-2011	Tractor with Dump Trailer(s)
	RZ- _____ # _____	36.05 T/A		

*Attach Additional Sheet if necessary

I hereby certify that the above-described materials are non-hazardous wastes as defined by 40 CFR 261 or any applicable state law. Further, that the above named materials are properly classified, described, packaged, marked and labeled, and are in proper condition for transportation according to the applicable regulations of the Department of Transportation.

Susan Crowley *Susan Crowley* _____
 Generator/Authorized Agent Name Signature Date Shipped

TRANSPORTER INFORMATION

Transporter Name: Las Vegas Paving

DOT # 191949

Address: 4420 S. Decatur

Truck Number: 192457

Las Vegas, NV 89103

Phone Number: (702) 353-4355

I certify no hazardous waste or other regulated substance was knowingly introduced to the waste while in my custody. The waste transported in this vehicle is the waste identified above, to the best of my knowledge.

Brian Brinkhoff *Brian Brinkhoff* _____ 10-7-10
 Name of Authorized Agent Signature Date Delivered

DISPOSAL SITE INFORMATION

Site Name: Apex Regional Landfill

Phone No. (702) 599-5920

Address: 13550 U.S. Hwy 93 Las Vegas, NV

I hereby acknowledge receipt of the above described materials
Jason Smith _____ 10-7-10
 Name (Print or Type) Signature Date Received

81 Environmental Tech
13550 N Highway 93
Las Vegas, NV 89165

Ticket Type: INBOUND INVOICE

Ticket Number: 2015
Date: 10/07/2010
Time In: 9:35 pm
Time Out: 10:02 pm

Customer: 001011 - NGE, LLC c/o Northgate Environ Mgmt

Vehicle/Container: 192460
Contract: Northgate Env. On Site Soils 3825 11
Comment: 3825 10 11244

Gross Weight: 127,080 LB Manual In
Tare Weight: 53,440 LB Manual Out
Net Weight: 73640 LB
Net Tons: 36.82

BOL: 12103

Origin	Yards	Material	Billing	Quantity
Not Applicable	0.00 YD	SW CONTAMINATED SOIL	36.82	TN

Driver:

Mig Hovish

Weighmaster:

IN - CARTERJ OUT - SMITHJ

Indemnification. Customer agrees, by signature above, to indemnify, hold harmless, and defend Republic Services, Inc., its subsidiaries, affiliates, employees, officers and directors from and against any and all liabilities, claims, penalties, forfeitures, suits and the costs and expenses incident thereto, including costs of defense, settlement, and reasonable attorney's fees, which may be incurred, as a result of death or injuries to any person, or damage to any property, contamination of or adverse effects on the environment, caused in whole or in part by the Customer, its employees, or subcontractors in disposing waste at this Facility. In the event Customer delivers Unacceptable Waste (as determined by Republic) Customer agrees to assume all expenses and obligations with the removal and/or resolution of any effects caused by the delivery of such Unacceptable Waste.

Indemnización. Cliente acuerda indemnizar, mantener inmune, y defender Republic Services, Inc., sus subsidiarios, compañías, divisiones, empleados, oficiales y directores contra de cualquiera y de todas responsabilidades, demandas, penas, pérdidas, juicios, pleitos y los costos incidente además, incluyendo costos de defensa, de acuerdo judicial, y de honorarios razonables del abogado, que pueden ser incurridos en, o como resultado de, la muerte o herida personal a cualquier persona, o daños a cualquier característica, propiedad, contaminación de la tierra o efectos ilícitos en esta Facilidad, causado entero o en parte por el cliente, sus empleados, o sus subcontratistas en botar basura en esta Facilidad. En el caso que el Cliente entrega, bota, basura (según lo determinado por Republic) en este Establecimiento basura inaceptable en los reglamentos de este Establecimiento, el Cliente se compromete asumir todos los costos y obligaciones con el retiro y/o la resolución de cualquier dano(s) causado por la entrega de tal basura inaceptable.



NON-HAZARDOUS WASTE MANIFEST

MANIFEST # 12103

GENERATOR INFORMATION

Generator Name: Tronox LLC
Address: P.O. Box 55
City: Henderson County: Clark
State: NV Zip: 89009
Site Location (if different): 560 W. Lake Mead
Henderson, NV 89015 (702) 592-7727

CUSTOMER/BILLING INFORMATION

Billing Name: NGE LLC c/o Northgate Environment Management
Address: 300 Frank Ogawa Plaza, Ste 510
City: Oakland County: Alameda
State: CA Zip: 94612

Table with 5 columns: Republic Services Approval #, Description of Waste, Volume/Weight, Expiration Date, Container Type. Row 1: 38251011244, Soil for disposal, 36.82, 12-31-2011, Tractor with Dump Trailer(s).

*Attach Additional Sheet if necessary

I hereby certify that the above-described materials are non-hazardous wastes as defined by 40 CFR 261 or any applicable state law. Further, that the above named materials are properly classified, described, packaged, marked and labeled, and are in proper condition for transportation according to the applicable regulations of the Department of Transportation.

Susan Crowley
Generator/Authorized Agent Name Signature Date Shipped

TRANSPORTER INFORMATION

Transporter Name: Las Vegas Paving DOT # 191949
Address: 4420 S. Decatur Truck Number: 2460
Las Vegas, NV 89103 Phone Number: (702) 353-4355

I certify no hazardous waste or other regulated substance was knowingly introduced to the waste while in my custody. The waste transported in this vehicle is the waste identified above, to the best of my knowledge.

Greg Honish
Name of Authorized Agent Signature Date Delivered 10-7-10

DISPOSAL SITE INFORMATION

Site Name: Apex Regional Landfill Phone No. (702) 599-5920
Address: 13550 U.S. Hwy 93 Las Vegas, NV

I hereby acknowledge receipt of the above described materials
Joe Collins
Name (Print or Type) Signature Date Received 10-7-10

81 Environmental Tech
13550 N Highway 93
Las Vegas, NV 89165

Ticket Type: INBOUND INVOICE

Ticket Number: 2016
Date: 10/07/2010
Time In: 10:00 pm
Time Out: 10:20 pm

Customer: 001011 - NGE, LLC c/o Northgate Environ Mgmt

Vehicle/Container: 81495P
Contract: Northgate Env. On Site Soils 3825 11
Comment: 3825 10 11244

Gross Weight: 135,380 LB Manual In
Tare Weight: 51,440 LB Manual Out
Net Weight: 83940 LB
Net Tons: 41.97

BOL: 12105

Origin	Yards	Material	Billing	Quantity
Not Applicable	0.00 YD	SW CONTAMINATED SOIL	41.97	TN

Driver: 

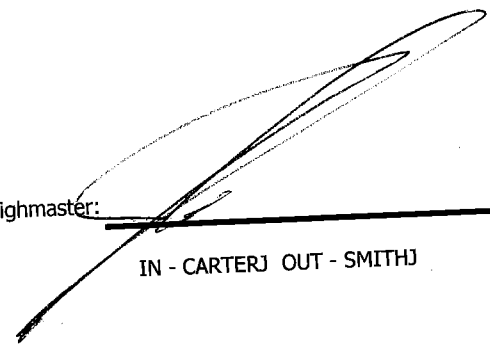
Weighmaster: 
IN - CARTERJ OUT - SMITHJ

Indemnification. Customer agrees, by signature above, to indemnify, hold harmless, and defend Republic Services, Inc., its subsidiaries, affiliates, employees, officers and directors from and against any and all liabilities, claims, penalties, forfeitures, suits and the costs and expenses incident thereto, including costs of defense, settlement, and reasonable attorney's fees, which may be incurred, as a result of death or injuries to any person, or damage to any property, contamination of or adverse effects on the environment, caused in whole or in part by the Customer, its employees, or subcontractors in disposing waste at this Facility. In the event Customer delivers Unacceptable Waste (as determined by Republic) Customer agrees to assume all expenses and obligations with the removal and/or resolution of any effects caused by the delivery of such Unacceptable Waste.

Indemnización. Cliente acuerda indemnizar, mantener inmune, y defender Republic Services, Inc., sus subsidiarios, compañías, divisiones, empleados, oficiales y directores contra de cualquiera y de todas responsabilidades, demandas, penas, pérdidas, juicios, pleitos y los costos incidente además, incluyendo costos de defensa, de acuerdo judicial, y de honorarios razonables del abogado, que pueden ser incurridos en, o como resultado de, la muerte o herida personal a cualquier persona, o daños a cualquier característica, propiedad, contaminación de la tierra o efectos ilícitos en esta Facultad, causado entero o en parte por el cliente, sus empleados, o sus subcontratistas en botar basura en esta Facultad. En el caso que el Cliente entrega, bota, basura (según lo determinado por Republic) en este Establecimiento basura inaceptable en los reglamentos de este Establecimiento, el Cliente se compromete asumir todos los costos y obligaciones con el retiro y/o la resolución de cualquier dano(s) causado por la entrega de tal basura inaceptable.



SR 40238

NON-HAZARDOUS WASTE MANIFEST

MANIFEST # 12105

GENERATOR INFORMATION

Generator Name: Tronox LLC
Address: P.O. Box 55
City: Henderson County: Clark
State: NV Zip: 89009
Site Location (if different): 560 W. Lake Mead
Henderson, NV 89015 (702) 592-7727

CUSTOMER/BILLING INFORMATION

Billing Name: NGE LLC c/o Northgate Environment Management
Address: 300 Frank Ogawa Plaza, Ste 510
City: Oakland County: Alameda
State: CA Zip: 94612

Table with 5 columns: Republic Services Approval #, Description of Waste, Volume/Weight, Expiration Date, Container Type. Row 1: 38251011244, Soil for disposal, 41.97 TON, 12-31-2011, Tractor with Dump Trailer(s)

*Attach Additional Sheet if necessary

I hereby certify that the above-described materials are non-hazardous wastes as defined by 40 CFR 261 or any applicable state law. Further, that the above named materials are properly classified, described, packaged, marked and labeled, and are in proper condition for transportation according to the applicable regulations of the Department of Transportation.

Susan Crowley
Generator/Authorized Agent Name Signature Date Shipped

TRANSPORTER INFORMATION

Transporter Name: Las Vegas Paving DOT # 191949
Address: 4420 S. Decatur Truck Number: 175
Las Vegas, NV 89103 Phone Number: (702) 353-4355

I certify no hazardous waste or other regulated substance was knowingly introduced to the waste while in my custody. The waste transported in this vehicle is the waste identified above, to the best of my knowledge.

Larry Hansberger
Name of Authorized Agent Signature Date Delivered 10-7-10

DISPOSAL SITE INFORMATION

Site Name: Apex Regional Landfill Phone No. (702) 599-5920
Address: 13550 U.S. Hwy 93 Las Vegas, NV

I hereby acknowledge receipt of the above described materials
Name (Print or Type) Signature Date Received 10-7-10

81 Environmental Tech
13550 N Highway 93
Las Vegas, NV 89165

Ticket Type: INBOUND INVOICE

Ticket Number: 2017
Date: 10/07/2010
Time In: 9:59 pm
Time Out: 10:23 pm

Customer: 001011 - NGE, LLC c/o Northgate Environ Mgmt

Vehicle/Container: 81496P
Contract: Northgate Env. On Site Soils 3825 11
Comment: 3825 10 11244

Gross Weight: 119,060 LB Manual In
Tare Weight: 50,660 LB Manual Out
Net Weight: 68400 LB
Net Tons: 34.20

BOL: 12106

Origin	Yards	Material	Billing	Quantity
Not Applicable	0.00 YD	SW CONTAMINATED SOIL	34.20	TN

Driver: _____

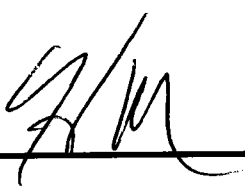

Weighmaster: _____

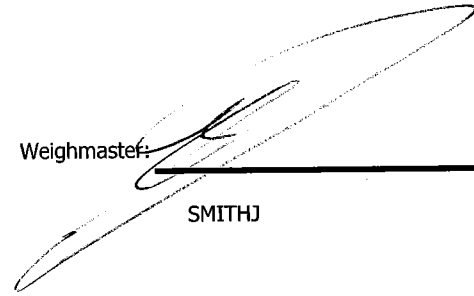

SMITHJ

Indemnification. Customer agrees, by signature above, to indemnify, hold harmless, and defend Republic Services, Inc., its subsidiaries, affiliates, employees, officers and directors from and against any and all liabilities, claims, penalties, forfeitures, suits and the costs and expenses incident thereto, including costs of defense, settlement, and reasonable attorney's fees, which may be incurred, as a result of death or injuries to any person, or damage to any property, contamination of or adverse effects on the environment, caused in whole or in part by the Customer, its employees, or subcontractors in disposing waste at this Facility. In the event Customer delivers Unacceptable Waste (as determined by Republic) Customer agrees to assume all expenses and obligations with the removal and/or resolution of any effects caused by the delivery of such Unacceptable Waste.

Indemnización. Cliente acuerda indemnizar, mantener inmune, y defender Republic Services, Inc., sus subsidiarios, compañías, divisiones, empleados, oficiales y directores contra de cualquiera y de todas responsabilidades, demandas, penas, pérdidas, juicios, pleitos y los costos incidente además, incluyendo costos de defensa, de acuerdo judicial, y de honorarios razonables del abogado, que pueden ser incurridos en, o como resultado de, la muerte o herida personal a cualquier persona, o daños a cualquier característica, propiedad, contaminación de la tierra o efectos ilícitos en esta Facilidad, causado entero o en parte por el cliente, sus empleados, o sus subcontratistas en botar basura en esta Facilidad. En el caso que el Cliente entrega, bota, basura (según lo determinado por Republic) en este Establecimiento basura inaceptable en los reglamentos de este Establecimiento, el Cliente se compromete asumir todos los costos y obligaciones con el retiro y/o la resolución de cualquier dano(s) causado por la entrega de tal basura inaceptable.



NON-HAZARDOUS WASTE MANIFEST

MANIFEST # 12106

GENERATOR INFORMATION

Generator Name: Tronox LLC
 Address: P.O. Box 55
 City: Henderson County: Clark
 State: NV Zip: 89009
 Site Location (if different): 560 W. Lake Mead
Henderson, NV 89015 (702) 592-7727

CUSTOMER/BILLING INFORMATION

Billing Name: NGE LLC c/o Northgate Environment Management
 Address: 300 Frank Ogawa Plaza, Ste 510
 City: Oakland County: Alameda
 State: CA Zip: 94612

Republic Services Approval #	Description of Waste	Volume/Weight	Expiration Date	Container Type
38251011244	Soil for disposal		12-31-2011	Tractor with Dump Trailer(s)
	RZ- _____ # _____	39.20 lb		

*Attach Additional Sheet if necessary

I hereby certify that the above-described materials are non-hazardous wastes as defined by 40 CFR 261 or any applicable state law. Further, that the above named materials are properly classified, described, packaged, marked and labeled, and are in proper condition for transportation according to the applicable regulations of the Department of Transportation.

Susan Crowley [Signature] _____
 Generator/Authorized Agent Name Signature Date Shipped

TRANSPORTER INFORMATION

Transporter Name: Las Vegas Paving DOT # 191949
 Address: 4420 S. Decatur Truck Number: 145
Las Vegas, NV 89103 Phone Number: (702) 353-4355

I certify no hazardous waste or other regulated substance was knowingly introduced to the waste while in my custody. The waste transported in this vehicle is the waste identified above, to the best of my knowledge.

[Signature] [Signature] 10-8-10
 Name of Authorized Agent Signature Date Delivered

DISPOSAL SITE INFORMATION

Site Name: Apex Regional Landfill Phone No. (702) 599-5920
 Address: 13550 U.S. Hwy 93 Las Vegas, NV

I hereby acknowledge receipt of the above described materials.
[Signature] 10-7-10
 Name (Print or Type) Signature Date Received

81 Environmental Tech
13550 N Highway 93
Las Vegas, NV 89165

Ticket Type: INBOUND INVOICE

Ticket Number: 2018
Date: 10/07/2010
Time In: 10:01 pm
Time Out: 10:24 pm

Customer: 001011 - NGE, LLC c/o Northgate Environ Mgmt

Vehicle/Container: 35903A
Contract: Northgate Env. On Site Soils 3825 11
Comment: 3825 10 11244

Gross Weight: 121,080 LB Manual In
Tare Weight: 60,280 LB Manual Out
Net Weight: 60800 LB
Net Tons: 30.40

BOL: 12108

Origin	Yards	Material	Billing	Quantity
Not Applicable	0.00 YD	SW CONTAMINATED SOIL	30.40 TN	

Driver: JAY MASON

Weighmaster: [Signature]
SMITHJ

Indemnification. Customer agrees, by signature above, to indemnify, hold harmless, and defend Republic Services, Inc., its subsidiaries, affiliates, employees, officers and directors from and against any and all liabilities, claims, penalties, forfeitures, suits and the costs and expenses incident thereto, including costs of defense, settlement, and reasonable attorney's fees, which may be incurred, as a result of death or injuries to any person, or damage to any property, contamination of or adverse effects on the environment, caused in whole or in part by the Customer, its employees, or subcontractors in disposing waste at this Facility. In the event Customer delivers Unacceptable Waste (as determined by Republic) Customer agrees to assume all expenses and obligations with the removal and/or resolution of any effects caused by the delivery of such Unacceptable Waste.

Indemnización. Cliente acuerda indemnizar, mantener inmune, y defender Republic Services, Inc., sus subsidiarios, compañías, divisiones, empleados, oficiales y directores contra de cualquiera y de todas responsabilidades, demandas, penas, pérdidas, juicios, pleitos y los costos incidente además, incluyendo costos de defensa, de acuerdo judicial, y de honorarios razonables del abogado, que pueden ser incurridos en, o como resultado de, la muerte o herida personal a cualquier persona, o daños a cualquier característica, propiedad, contaminación de la tierra o efectos ilícitos en esta Facilidad, causado entero o en parte por el cliente, sus empleados, o sus subcontratistas en botar basura en esta Facilidad. En el caso que el Cliente entrega, bota, basura (según lo determinado por Republic) en este Establecimiento basura inaceptable en los reglamentos de este Establecimiento, el Cliente se compromete asumir todos los costos y obligaciones con el retiro y/o la resolución de cualquier dano(s) causado por la entrega de tal basura inaceptable.



NON-HAZARDOUS WASTE MANIFEST

MANIFEST # 12108

GENERATOR INFORMATION

Generator Name: Tronox LLC
 Address: P.O. Box 55
 City: Henderson County: Clark
 State: NV Zip: 89009
 Site Location (if different): 560 W. Lake Mead
Henderson, NV 89015 (702) 592-7727

CUSTOMER/BILLING INFORMATION

Billing Name: NGE LLC c/o Northgate Environment Management
 Address: 300 Frank Ogawa Plaza, Ste 510
 City: Oakland County: Alameda
 State: CA Zip: 94612

Republic Services Approval #	Description of Waste	Volume/Weight	Expiration Date	Container Type
38251011244	Soil for disposal		12-31-2011	Tractor with Dump Trailer(s)
	RZ- _____ # _____	30.40 TON		

*Attach Additional Sheet if necessary

I hereby certify that the above-described materials are non-hazardous wastes as defined by 40 CFR 261 or any applicable state law. Further, that the above named materials are properly classified, described, packaged, marked and labeled, and are in proper condition for transportation according to the applicable regulations of the Department of Transportation.

Susan Crowley [Signature] _____
 Generator/Authorized Agent Name Signature Date Shipped

TRANSPORTER INFORMATION

Transporter Name: Las Vegas Paving DOT # 191949
 Address: 4420 S. Decatur Truck Number: 07
Las Vegas, NV 89103 Phone Number: (702) 353-4355

I certify no hazardous waste or other regulated substance was knowingly introduced to the waste while in my custody. The waste transported in this vehicle is the waste identified above, to the best of my knowledge.

Weidco BC [Signature] 10-7-10
 Name of Authorized Agent Signature Date Delivered

DISPOSAL SITE INFORMATION

Site Name: Apex Regional Landfill Phone No. (702) 599-5920
 Address: 13550 U.S. Hwy 93 Las Vegas, NV

I hereby acknowledge receipt of the above described materials
[Signature] _____
 Name (Print or Type) Signature Date Received

81 Environmental Tech
13550 N Highway 93
Las Vegas, NV 89165

Ticket Type: INBOUND INVOICE

Ticket Number: 2019
Date: 10/07/2010
Time In: 10:03 pm
Time Out: 10:28 pm

Customer: 001011 - NGE, LLC c/o Northgate Environ Mgmt

Vehicle/Container: 34330A
Contract: Northgate Env. On Site Soils 3825 11
Comment: 3825 10 11244

Gross Weight: 125,580 LB Manual In
Tare Weight: 53,260 LB Manual Out
Net Weight: 72,320 LB
Net Tons: 36.16

BOL: 12107

Origin	Yards	Material	Billing	Quantity
Not Applicable	0.00 YD	SW CONTAMINATED SOIL	36.16	TN

Driver: Thomas R. [Signature]

Weighmaster: [Signature]
SMITHJ

Indemnification. Customer agrees, by signature above, to indemnify, hold harmless, and defend Republic Services, Inc., its subsidiaries, affiliates, employees, officers and directors from and against any and all liabilities, claims, penalties, forfeitures, suits and the costs and expenses incident thereto, including costs of defense, settlement, and reasonable attorney's fees, which may be incurred, as a result of death or injuries to any person, or damage to any property, contamination of or adverse effects on the environment, caused in whole or in part by the Customer, its employees, or subcontractors in disposing waste at this Facility. In the event Customer delivers Unacceptable Waste (as determined by Republic) Customer agrees to assume all expenses and obligations with the removal and/or resolution of any effects caused by the delivery of such Unacceptable Waste.

Indemnización. Cliente acuerda indemnizar, mantener inmune, y defender Republic Services, Inc., sus subsidiarios, companias, divisiones, empleados, oficiales y directores contra de cualquiera y de todas responsabilidades, demandas, penas, pérdidas, juicios, pleitos y los costos incidente además, incluyendo costos de defensa, de acuerdo judicial, y de honorarios razonables del abogado; que pueden ser incurridos en, o como resultado de, la muerte o herida persona a cualquier persona, o daños a cualquier característica, propiedad, contaminación de la tierra o efectos ilicitos en esta Facilidat, causado entero o en parte por el cliente, sus empleados, o sus subcontratistas en botar basura en est Facilidat. En el caso que el Cliente entrega, bota, basura (según lo determinado por Republic) en este Establecimient basura inaceptable en los reglamentos de este Establecimiento, el Cliente se compromete asumir todos los costos obligaciones con el retiro y/o la resolución de cualquier dano(s) causado por la entrega de tal basura inaceptable.



NON-HAZARDOUS WASTE MANIFEST

MANIFEST # 12107

GENERATOR INFORMATION

Generator Name: Tronox LLC

Address: P.O. Box 55

City: Henderson County: Clark

State: NV Zip: 89009

Site Location (if different): 560 W. Lake Mead
Henderson, NV 89015 (702) 592-7727

CUSTOMER/BILLING INFORMATION

Billing Name: NGE LLC c/o Northgate Environment Management

Address: 300 Frank Ogawa Plaza, Ste 510

City: Oakland County: Alameda

State: CA Zip: 94612

Republic Services Approval #	Description of Waste	Volume/Weight	Expiration Date	Container Type
38251011244	Soil for disposal		12-31-2011	Tractor with Dump Trailer(s)
	RZ- _____ # _____	<i>3.6 TON</i>		

*Attach Additional Sheet if necessary

I hereby certify that the above-described materials are non-hazardous wastes as defined by 40 CFR 261 or any applicable state law. Further, that the above named materials are properly classified, described, packaged, marked and labeled, and are in proper condition for transportation according to the applicable regulations of the Department of Transportation.

Susan Crowley *SM Crowley* _____
 Generator/Authorized Agent Name Signature Date Shipped

TRANSPORTER INFORMATION

Transporter Name: Las Vegas Paving

DOT # 191949

Address: 4420 S. Decatur

Truck Number: 981

Las Vegas, NV 89103

Phone Number: (702) 353-4355

I certify no hazardous waste or other regulated substance was knowingly introduced to the waste while in my custody. The waste transported in this vehicle is the waste identified above, to the best of my knowledge.

Tom Rawley, JR *Thomas Rawley, JR* 10-7-10
 Name of Authorized Agent Signature Date Delivered

DISPOSAL SITE INFORMATION

Site Name: Apex Regional Landfill

Phone No. (702) 599-5920

Address: 13550 U.S. Hwy 93 Las Vegas, NV

I hereby acknowledge receipt of the above described materials

Jason Smith _____ *10-7-10*
 Name (Print or Type) Signature Date Received

81 Environmental Tech
13550 N Highway 93
Las Vegas, NV 89165

Ticket Type: INBOUND INVOICE

Ticket Number: 2020
Date: 10/07/2010
Time In: 10:08 pm
Time Out: 10:31 pm

Customer: 001011 - NGE, LLC c/o Northgate Environ Mgmt

Vehicle/Container: 81460P

Gross Weight: 118,160 LB Manual In
Tare Weight: 59,040 LB Manual Out
Net Weight: 59120 LB
Net Tons: 29.56

Contract: Northgate Env. On Site Soils 3825 11

Comment: 3825 10 11244

BOL: 12109

Origin	Yards	Material	Billing	Quantity
Not Applicable	0.00 YD	SW CONTAMINATED SOIL	29.56	TN

Driver: _____

Weighmaster: _____

SMITHJ

Indemnification. Customer agrees, by signature above, to indemnify, hold harmless, and defend Republic Services, Inc., its subsidiaries, affiliates, employees, officers and directors from and against any and all liabilities, claims, penalties, forfeitures, suits and the costs and expenses incident thereto, including costs of defense, settlement, and reasonable attorney's fees, which may be incurred, as a result of death or injuries to any person, or damage to any property, contamination of or adverse effects on the environment, caused in whole or in part by the Customer, its employees, or subcontractors in disposing waste at this Facility. In the event Customer delivers Unacceptable Waste (as determined by Republic) Customer agrees to assume all expenses and obligations with the removal and/or resolution of any effects caused by the delivery of such Unacceptable Waste.

Indemnización. Cliente acuerda indemnizar, mantener inmune, y defender Republic Services, Inc., sus subsidiarios, compañías, divisiones, empleados, oficiales y directores contra de cualquiera y de todas responsabilidades, demandas, penas, pérdidas, juicios, pleitos y los costos incidente además, incluyendo costos de defensa, de acuerdo judicial, y de honorarios razonables del abogado, que pueden ser incurridos en, o como resultado de, la muerte o herida personal a cualquier persona, o daños a cualquier característica, propiedad, contaminación de la tierra o efectos ilícitos en esta Facilidad, causado entero o en parte por el cliente, sus empleados, o sus subcontratistas en botar basura en esta Facilidad. En el caso que el Cliente entrega, bota, basura (según lo determinado por Republic) en este Establecimiento basura inaceptable en los reglamentos de este Establecimiento, el Cliente se compromete asumir todos los costos y obligaciones con el retiro y/o la resolución de cualquier dano(s) causado por la entrega de tal basura inaceptable.



NON-HAZARDOUS WASTE MANIFEST

MANIFEST # 12109

GENERATOR INFORMATION

Generator Name: Tronox LLC
 Address: P.O. Box 55
 City: Henderson County: Clark
 State: NV Zip: 89009
 Site Location (if different): 560 W. Lake Mead
Henderson, NV 89015 (702) 592-7727

CUSTOMER/BILLING INFORMATION

Billing Name: NGE LLC c/o Northgate Environment Management
 Address: 300 Frank Ogawa Plaza, Ste 510
 City: Oakland County: Alameda
 State: CA Zip: 94612

Republic Services Approval #	Description of Waste	Volume/Weight	Expiration Date	Container Type
38251011244	Soil for disposal		12-31-2011	Tractor with Dump Trailer(s)
	RZ-_____ # _____	<i>2.5 to 7.0</i>		

*Attach Additional Sheet if necessary

I hereby certify that the above-described materials are non-hazardous wastes as defined by 40 CFR 261 or any applicable state law. Further, that the above named materials are properly classified, described, packaged, marked and labeled, and are in proper condition for transportation according to the applicable regulations of the Department of Transportation.

Susan Crowley
 Generator/Authorized Agent Name Signature Date Shipped

TRANSPORTER INFORMATION

Transporter Name: Las Vegas Paving DOT # 191949
 Address: 4420 S. Decatur Truck Number: 27
Las Vegas, NV 89103 Phone Number: (702) 353-4355

I certify no hazardous waste or other regulated substance was knowingly introduced to the waste while in my custody. The waste transported in this vehicle is the waste identified above, to the best of my knowledge.

Daniel Cardenas
 Name of Authorized Agent Signature Date Delivered 10-7-2010

DISPOSAL SITE INFORMATION

Site Name: Apex Regional Landfill Phone No. (702) 599-5920
 Address: 13550 U.S. Hwy 93 Las Vegas, NV

I hereby acknowledge receipt of the above described materials
Tronox
 Name (Print or Type) Signature Date Received 10-7-10

81 Environmental Tech
13550 N Highway 93
Las Vegas, NV 89165

Ticket Type: INBOUND INVOICE

Ticket Number: 2021
Date: 10/07/2010
Time In: 10:08 pm
Time Out: 10:33 pm

Customer: 001011 - NGE, LLC c/o Northgate Environ Mgmt

Vehicle/Container: 82418P
Contract: Northgate Env. On Site Soils 3825 11
Comment: 3825 10 11244

Gross Weight: 126,140 LB Manual In
Tare Weight: 60,660 LB Manual Out
Net Weight: 65480 LB
Net Tons: 32.74

1111
BOL: ~~12211~~

Origin	Yards	Material	Billing Quantity
Not Applicable	0.00 YD	SW CONTAMINATED SOIL	32.74 TN

Driver: 

Weighmaster: 

SMITHJ

Indemnification. Customer agrees, by signature above, to indemnify, hold harmless, and defend Republic Services, Inc., its subsidiaries, affiliates, employees, officers and directors from and against any and all liabilities, claims, penalties, forfeitures, suits and the costs and expenses incident thereto, including costs of defense, settlement, and reasonable attorney's fees, which may be incurred, as a result of death or injuries to any person, or damage to any property, contamination of or adverse effects on the environment, caused in whole or in part by the Customer, its employees, or subcontractors in disposing waste at this Facility. In the event Customer delivers Unacceptable Waste (as determined by Republic) Customer agrees to assume all expenses and obligations with the removal and/or resolution of any effects caused by the delivery of such Unacceptable Waste.

Indemnización. Cliente acuerda indemnizar, mantener inmune, y defender Republic Services, Inc., sus subsidiarios, compañías, divisiones, empleados, oficiales y directores contra de cualquiera y de todas responsabilidades, demandas, penas, pérdidas, juicios, pleitos y los costos incidente además, incluyendo costos de defensa, de acuerdo judicial, y de honorarios razonables del abogado, que pueden ser incurridos en, o como resultado de, la muerte o herida personal a cualquier persona, o daños a cualquier característica, propiedad, contaminación de la tierra o efectos ilícitos en esta Facilidad, causado entero o en parte por el cliente, sus empleados, o sus subcontratistas en botar basura en esta Facilidad. En el caso que el Cliente entrega, bota, basura (según lo determinado por Republic) en este Establecimiento basura inaceptable en los reglamentos de este Establecimiento, el Cliente se compromete asumir todos los costos y obligaciones con el retiro y/o la resolución de cualquier dano(s) causado por la entrega de tal basura inaceptable.



NON-HAZARDOUS WASTE MANIFEST

MANIFEST # 12111

GENERATOR INFORMATION

Generator Name: Tronox LLC

Address: P.O. Box 55

City: Henderson County: Clark

State: NV Zip: 89009

Site Location (if different): 560 W. Lake Mead

Henderson, NV 89015 (702) 592-7727

CUSTOMER/BILLING INFORMATION

Billing Name: NGE LLC c/o Northgate Environment Management

Address: 300 Frank Ogawa Plaza, Ste 510

City: Oakland County: Alameda

State: CA Zip: 94612

Republic Services Approval #	Description of Waste	Volume/Weight	Expiration Date	Container Type
38251011244	Soil for disposal		12-31-2011	Tractor with Dump Trailer(s)
	RZ-_____#_____	32.74 TL		

*Attach Additional Sheet if necessary

I hereby certify that the above-described materials are non-hazardous wastes as defined by 40 CFR 261 or any applicable state law. Further, that the above named materials are properly classified, described, packaged, marked and labeled, and are in proper condition for transportation according to the applicable regulations of the Department of Transportation.

Susan Crowley
Generator/Authorized Agent Name

Susan Crowley
Signature

Date Shipped

TRANSPORTER INFORMATION

Transporter Name: Las Vegas Paving

DOT # 191949

Address: 4420 S. Decatur

Truck Number: 220

Las Vegas, NV 89103

Phone Number: (702) 353-4355

I certify no hazardous waste or other regulated substance was knowingly introduced to the waste while in my custody. The waste transported in this vehicle is the waste identified above, to the best of my knowledge.

STEVE TAYLOR
Name of Authorized Agent

[Signature]
Signature

10-7-10
Date Delivered

DISPOSAL SITE INFORMATION

Site Name: Apex Regional Landfill

Phone No. (702) 599-5920

Address: 13550 U.S. Hwy 93 Las Vegas, NV

I hereby acknowledge receipt of the above described materials

Jessie Smith
Name (Print or Type)

[Signature]
Signature

10-7-10
Date Received

81

Environmental Tech
13550 N Highway 93
Las Vegas, NV 89165

Ticket Type: INBOUND INVOICE

Ticket Number: 2022
Date: 10/07/2010
Time In: 10:09 pm
Time Out: 10:34 pm

Customer: 001011 - NGE, LLC c/o Northgate Environ Mgmt

Vehicle/Container: 86053P
Contract: Northgate Env. On Site Soils 3825 11
Comment: 3825 10 11244

Gross Weight: 120,740 LB Manual In
Tare Weight: 58,100 LB Manual Out
Net Weight: 62640 LB
Net Tons: 31.32

BOL: 12110

Origin	Yards	Material	Billing Quantity
Not Applicable	0.00 YD	SW CONTAMINATED SOIL	31.32 TN

Driver:

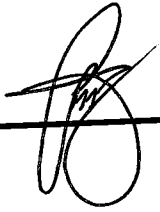

Weighmaster:

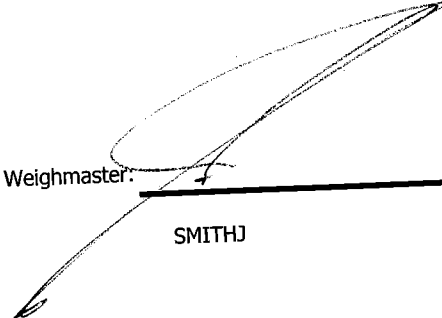

SMITHJ

Indemnification. Customer agrees, by signature above, to indemnify, hold harmless, and defend Republic Services, Inc., its subsidiaries, affiliates, employees, officers and directors from and against any and all liabilities, claims, penalties, forfeitures, suits and the costs and expenses incident thereto, including costs of defense, settlement, and reasonable attorney's fees, which may be incurred, as a result of death or injuries to any person, or damage to any property, contamination of or adverse effects on the environment, caused in whole or in part by the Customer, its employees, or subcontractors in disposing waste at this Facility. In the event Customer delivers Unacceptable Waste (as determined by Republic) Customer agrees to assume all expenses and obligations with the removal and/or resolution of any effects caused by the delivery of such Unacceptable Waste.

Indemnización. Cliente acuerda indemnizar, mantener inmune, y defender Republic Services, Inc., sus subsidiarios, compañías, divisiones, empleados, oficiales y directores contra de cualquiera y de todas responsabilidades, demandas, penas, pérdidas, juicios, pleitos y los costos incidente además, incluyendo costos de defensa, de acuerdo judicial, y de honorarios razonables del abogado, que pueden ser incurridos en, o como resultado de, la muerte o herida personal a cualquier persona, o daños a cualquier característica, propiedad, contaminación de la tierra o efectos ilícitos en esta Facultad, causado entero o en parte por el cliente, sus empleados, o sus subcontratistas en botar basura en esta Facultad. En el caso que el Cliente entrega, bota, basura (según lo determinado por Republic) en este Establecimiento basura inaceptable en los reglamentos de este Establecimiento, el Cliente se compromete asumir todos los costos y obligaciones con el retiro y/o la resolución de cualquier dano(s) causado por la entrega de tal basura inaceptable.



NON-HAZARDOUS WASTE MANIFEST

MANIFEST # 12110

GENERATOR INFORMATION

Generator Name: Tronox LLCAddress: P.O. Box 55City: Henderson County: ClarkState: NV Zip: 89009Site Location (if different): 560 W. Lake MeadHenderson, NV 89015 (702) 592-7727

CUSTOMER/BILLING INFORMATION

Billing Name: NGE LLC c/o Northgate Environment ManagementAddress: 300 Frank Ogawa Plaza, Ste 510City: Oakland County: AlamedaState: CA Zip: 94612

Republic Services Approval #	Description of Waste	Volume/Weight	Expiration Date	Container Type
38251011244	Soil for disposal		12-31-2011	Tractor with Dump Trailer(s)
	RZ- _____ # _____	31.32 TW		

*Attach Additional Sheet if necessary

I hereby certify that the above-described materials are non-hazardous wastes as defined by 40 CFR 261 or any applicable state law. Further, that the above named materials are properly classified, described, packaged, marked and labeled, and are in proper condition for transportation according to the applicable regulations of the Department of Transportation.

Susan Crowley
 Generator/Authorized Agent Name

Susan Crowley
 Signature

Date Shipped

TRANSPORTER INFORMATION

Transporter Name: Las Vegas PavingDOT # 191949Address: 4420 S. DecaturTruck Number: 261Las Vegas, NV 89103Phone Number: (702) 353-4355

I certify no hazardous waste or other regulated substance was knowingly introduced to the waste while in my custody. The waste transported in this vehicle is the waste identified above, to the best of my knowledge.

Patrick Wood
 Name of Authorized Agent

Patrick Wood
 Signature

705710
 Date Delivered

DISPOSAL SITE INFORMATION

Site Name: Apex Regional LandfillPhone No. (702) 599-5920Address: 13550 U.S. Hwy 93 Las Vegas, NV

I hereby acknowledge receipt of the above described materials

Jean Smith
 Name (Print or Type)

Jean Smith
 Signature

10-2-10
 Date Received

81 Environmental Tech
13550 N Highway 93
Las Vegas, NV 89165

Ticket Type: INBOUND INVOICE

Ticket Number: 2023
Date: 10/07/2010
Time In: 10:13 pm
Time Out: 10:36 pm

Customer: 001011 - NGE, LLC c/o Northgate Environ Mgmt

Vehicle/Container: 76810P
Contract: Northgate Env. On Site Soils 3825 11
Comment: 3825 10 11244

Gross Weight: 123,900 LB Manual In
Tare Weight: 56,980 LB Manual Out
Net Weight: 66920 LB
Net Tons: 33.46

BOL: 12112

Origin	Yards	Material	Billing	Quantity
Not Applicable	0.00 YD	SW CONTAMINATED SOIL	33.46	TN

Driver:



Weighmaster:

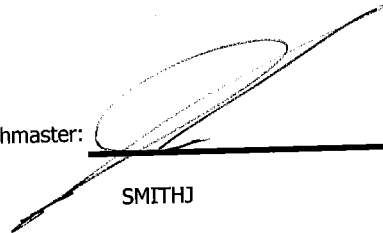

SMITHJ

Indemnification. Customer agrees, by signature above, to indemnify, hold harmless, and defend Republic Services, Inc., its subsidiaries, affiliates, employees, officers and directors from and against any and all liabilities, claims, penalties, forfeitures, suits and the costs and expenses incident thereto, including costs of defense, settlement, and reasonable attorney's fees, which may be incurred, as a result of death or injuries to any person, or damage to any property, contamination of or adverse effects on the environment, caused in whole or in part by the Customer, its employees, or subcontractors in disposing waste at this Facility. In the event Customer delivers Unacceptable Waste (as determined by Republic) Customer agrees to assume all expenses and obligations with the removal and/or resolution of any effects caused by the delivery of such Unacceptable Waste.

Indemnización. Cliente acuerda indemnizar, mantener inmune, y defender Republic Services, Inc., sus subsidiarios, compañías, divisiones, empleados, oficiales y directores contra de cualquiera y de todas responsabilidades, demandas, penas, pérdidas, juicios, pleitos y los costos incidente además, incluyendo costos de defensa, de acuerdo judicial, y de honorarios razonables del abogado, que pueden ser incurridos en, o como resultado de, la muerte o herida personal a cualquier persona, o daños a cualquier característica, propiedad, contaminación de la tierra o efectos ilícitos en esta Facilidad, causado entero o en parte por el cliente, sus empleados, o sus subcontratistas en botar basura en esta Facilidad. En el caso que el Cliente entrega, bota, basura (según lo determinado por Republic) en este Establecimiento basura inaceptable en los reglamentos de este Establecimiento, el Cliente se compromete asumir todos los costos y obligaciones con el retiro y/o la resolución de cualquier dano(s) causado por la entrega de tal basura inaceptable.



NON-HAZARDOUS WASTE MANIFEST

MANIFEST # 12112

GENERATOR INFORMATION

Generator Name: Tronox LLC

Address: P.O. Box 55

City: Henderson County: Clark

State: NV Zip: 89009

Site Location (if different): 560 W. Lake Mead

Henderson, NV 89015 (702) 592-7727

CUSTOMER/BILLING INFORMATION

Billing Name: NGE LLC c/o Northgate Environment Management

Address: 300 Frank Ogawa Plaza, Ste 510

City: Oakland County: Alameda

State: CA Zip: 94612

Republic Services Approval #	Description of Waste	Volume/Weight	Expiration Date	Container Type
38251011244	Soil for disposal		12-31-2011	Tractor with Dump Trailer(s)
	RZ- _____ # _____	33.46 TON		

*Attach Additional Sheet if necessary

I hereby certify that the above-described materials are non-hazardous wastes as defined by 40 CFR 261 or any applicable state law. Further, that the above named materials are properly classified, described, packaged, marked and labeled, and are in proper condition for transportation according to the applicable regulations of the Department of Transportation.

Susan Crowley
Generator/Authorized Agent Name
Signature: [Handwritten Signature]
Date Shipped

TRANSPORTER INFORMATION

Transporter Name: Las Vegas Paving

DOT # 191949

Address: 4420 S. Decatur

Truck Number: 241

Las Vegas, NV 89103

Phone Number: (702) 353-4355

I certify no hazardous waste or other regulated substance was knowingly introduced to the waste while in my custody. The waste transported in this vehicle is the waste identified above, to the best of my knowledge.

[Handwritten Signature]
Name of Authorized Agent
Signature: [Handwritten Signature]
Date Delivered: 10-7-2010

DISPOSAL SITE INFORMATION

Site Name: Apex Regional Landfill

Phone No: (702) 599-5920

Address: 13550 U.S. Hwy 93 Las Vegas, NV

I hereby acknowledge receipt of the above described materials

[Handwritten Signature]
Name (Print or Type)
Signature
Date Received

REPRINT

81 Environmental Tech
13550 N Highway 93
Las Vegas, NV 89165

Ticket Type: INBOUND INVOICE

Ticket Number: 2024
Date: 10/07/2010
Time In: 9:52 pm
Time Out: 10:38 pm

Customer: 001011 - NGE, LLC c/o Northgate Environ Mgmt

Vehicle/Container: 81494P
Contract: Northgate Env. On Site Soils 3825 11
Comment: 3825 10 11244

Gross Weight: 121,820 LB Manual In
Tare Weight: 51,200 LB Manual Out
Net Weight: 70620 LB
Net Tons: 35.31

BOL: 12104

Origin	Yards	Material	Billing Quantity
Not Applicable	0.00 YD	SW CONTAMINATED SOIL	35.31 TN

Driver: _____



Weighmaster: _____

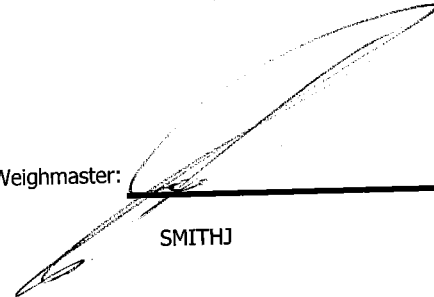

SMITHJ

Indemnification. Customer agrees, by signature above, to indemnify, hold harmless, and defend Republic Services, Inc., its subsidiaries, affiliates, employees, officers and directors from and against any and all liabilities, claims, penalties, forfeitures, suits and the costs and expenses incident thereto, including costs of defense, settlement, and reasonable attorney's fees, which may be incurred, as a result of death or injuries to any person, or damage to any property, contamination of or adverse effects on the environment, caused in whole or in part by the Customer, its employees, or subcontractors in disposing waste at this Facility. In the event Customer delivers Unacceptable Waste (as determined by Republic) Customer agrees to assume all expenses and obligations with the removal and/or resolution of any effects caused by the delivery of such Unacceptable Waste.

Indemnización. Cliente acuerda indemnizar, mantener inmune, y defender Republic Services, Inc., sus subsidiarios, compañías, divisiones, empleados, oficiales y directores contra de cualquiera y de todas responsabilidades, demandas, penas, pérdidas, juicios, pleitos y los costos incidente además, incluyendo costos de defensa, de acuerdo judicial, y de honorarios razonables del abogado, que pueden ser incurridos en, o como resultado de, la muerte o herida personal a cualquier persona, o daños a cualquier característica, propiedad, contaminación de la tierra o efectos ilícitos en esta Facilidad, causado entero o en parte por el cliente, sus empleados, o sus subcontratistas en botar basura en esta Facilidad. En el caso que el Cliente entrega, bota, basura (según lo determinado por Republic) en este Establecimiento basura inaceptable en los reglamentos de este Establecimiento, el Cliente se compromete asumir todos los costos y obligaciones con el retiro y/o la resolución de cualquier dano(s) causado por la entrega de tal basura inaceptable.



NON-HAZARDOUS WASTE MANIFEST

MANIFEST # 12104

GENERATOR INFORMATION

Generator Name: Tronox LLC

Address: P.O. Box 55

City: Henderson County: Clark

State: NV Zip: 89009

Site Location (if different): 560 W. Lake Mead

Henderson, NV 89015 (702) 592-7727

CUSTOMER/BILLING INFORMATION

Billing Name: NGE LLC c/o Northgate Environment Management

Address: 300 Frank Ogawa Plaza, Ste 510

City: Oakland County: Alameda

State: CA Zip: 94612

Republic Services Approval #	Description of Waste	Volume/Weight	Expiration Date	Container Type
38251011244	Soil for disposal		12-31-2011	Tractor with Dump Trailer(s)
	RZ- #	35.3/70		

*Attach Additional Sheet if necessary

I hereby certify that the above-described materials are non-hazardous wastes as defined by 40 CFR 261 or any applicable state law. Further, that the above named materials are properly classified, described, packaged, marked and labeled, and are in proper condition for transportation according to the applicable regulations of the Department of Transportation.

Susan Crowley Generator/Authorized Agent Name Signature Date Shipped

TRANSPORTER INFORMATION

Transporter Name: Las Vegas Paving

DOT # 191949

Address: 4420 S. Decatur

Truck Number: 125

Las Vegas, NV 89103

Phone Number: (702) 353-4355

I certify no hazardous waste or other regulated substance was knowingly introduced to the waste while in my custody. The waste transported in this vehicle is the waste identified above, to the best of my knowledge.

Calvin Paguyo Calvin Paguyo Signature Date Delivered 10-07-10

DISPOSAL SITE INFORMATION

Site Name: Apex Regional Landfill

Phone No. (702) 599-5920

Address: 13550 U.S. Hwy 93 Las Vegas, NV

I hereby acknowledge receipt of the above described materials

Name (Print or Type) Signature Date Received 10-7-10

81 Environmental Tech
13550 N Highway 93
Las Vegas, NV 89165

Ticket Type: INBOUND INVOICE

Ticket Number: 2025
Date: 10/07/2010
Time In: 10:17 pm
Time Out: 10:41 pm

Customer: 001011 - NGE, LLC c/o Northgate Environ Mgmt

Vehicle/Container: 76811P
Contract: Northgate Env. On Site Soils 3825 11
Comment: 3825 10 11244

Gross Weight: 120,980 LB Manual In
Tare Weight: 53,120 LB Manual Out
Net Weight: 67,860 LB
Net Tons: 33.93

BOL: 12113

Origin	Yards	Material	Billing	Quantity
Not Applicable	0.00 YD	SW CONTAMINATED SOIL	33.93	TN

Driver:



Weighmaster

SMITHJ

Indemnification. Customer agrees, by signature above, to indemnify, hold harmless, and defend Republic Services, Inc., its subsidiaries, affiliates, employees, officers and directors from and against any and all liabilities, claims, penalties, forfeitures, suits and the costs and expenses incident thereto, including costs of defense, settlement, and reasonable attorney's fees, which may be incurred, as a result of death or injuries to any person, or damage to any property, contamination of or adverse effects on the environment, caused in whole or in part by the Customer, its employees, or subcontractors in disposing waste at this Facility. In the event Customer delivers Unacceptable Waste (as determined by Republic) Customer agrees to assume all expenses and obligations with the removal and/or resolution of any effects caused by the delivery of such Unacceptable Waste.

Indemnización. Cliente acuerda indemnizar, mantener inmune, y defender Republic Services, Inc., sus subsidiarios, compañías, divisiones, empleados, oficiales y directores contra de cualquiera y de todas responsabilidades, demandas, penas, pérdidas, juicios, pleitos y los costos incidente además, incluyendo costos de defensa, de acuerdo judicial, y de honorarios razonables del abogado, que pueden ser incurridos en, o como resultado de, la muerte o herida personal a cualquier persona, o daños a cualquier característica, propiedad, contaminación de la tierra o efectos ilícitos en esta Facilidad, causado entero o en parte por el cliente, sus empleados, o sus subcontratistas en botar basura en esta Facilidad. En el caso que el Cliente entrega, bota, basura (según lo determinado por Republic) en este Establecimiento basura inaceptable en los reglamentos de este Establecimiento, el Cliente se compromete asumir todos los costos y obligaciones con el retiro y/o la resolución de cualquier dano(s) causado por la entrega de tal basura inaceptable.



NON-HAZARDOUS WASTE MANIFEST

MANIFEST # 12113

GENERATOR INFORMATION

Generator Name: Tronox LLC

Address: P.O. Box 55

City: Henderson County: Clark

State: NV Zip: 89009

Site Location (if different): 560 W. Lake Mead

Henderson, NV 89015 (702) 592-7727

CUSTOMER/BILLING INFORMATION

Billing Name: NGE LLC c/o Northgate Environment Management

Address: 300 Frank Ogawa Plaza, Ste 510

City: Oakland County: Alameda

State: CA Zip: 94612

Table with 5 columns: Republic Services Approval #, Description of Waste, Volume/Weight, Expiration Date, Container Type. Row 1: 38251011244, Soil for disposal, 33.93 Tons, 12-31-2011, Tractor with Dump Trailer(s).

*Attach Additional Sheet if necessary

I hereby certify that the above-described materials are non-hazardous wastes as defined by 40 CFR 261 or any applicable state law. Further, that the above named materials are properly classified, described, packaged, marked and labeled, and are in proper condition for transportation according to the applicable regulations of the Department of Transportation.

Susan Crowley (Name), Tom Crowley (Signature), Date Shipped

TRANSPORTER INFORMATION

Transporter Name: Las Vegas Paving

DOT # 191949

Address: 4420 S. Decatur

Truck Number: 242

Las Vegas, NV 89103

Phone Number: (702) 353-4355

I certify no hazardous waste or other regulated substance was knowingly introduced to the waste while in my custody. The waste transported in this vehicle is the waste identified above, to the best of my knowledge.

Mike Heffern (Name), Mike Heffern (Signature), 10-7-10 (Date Delivered)

DISPOSAL SITE INFORMATION

Site Name: Apex Regional Landfill

Phone No. (702) 599-5920

Address: 13550 U.S. Hwy 93 Las Vegas, NV

I hereby acknowledge receipt of the above described materials

Name (Print or Type), Signature, Date Received

81 Environmental Tech
13550 N Highway 93
Las Vegas, NV 89165

Ticket Type: INBOUND INVOICE

Ticket Number: 2026
Date: 10/07/2010
Time In: 10:32 pm
Time Out: 10:59 pm

Customer: 001011 - NGE, LLC c/o Northgate Environ Mgmt

Vehicle/Container: 68263P
Contract: Northgate Env. On Site Soils 3825 11
Comment: 3825 10 11244

Gross Weight: 123,560 LB Manual In
Tare Weight: 53,360 LB Manual Out
Net Weight: 70200 LB
Net Tons: 35.10

BOL: 12114

Origin	Yards	Material	Billing	Quantity
Not Applicable	0.00 YD	SW CONTAMINATED SOIL	35.10	TN

Driver: _____

Weighmaster: _____

SMITHJ

Indemnification. Customer agrees, by signature above, to indemnify, hold harmless, and defend Republic Services, Inc., its subsidiaries, affiliates, employees, officers and directors from and against any and all liabilities, claims, penalties, forfeitures, suits and the costs and expenses incident thereto, including costs of defense, settlement, and reasonable attorney's fees, which may be incurred, as a result of death or injuries to any person, or damage to any property, contamination of or adverse effects on the environment, caused in whole or in part by the Customer, its employees, or subcontractors in disposing waste at this Facility. In the event Customer delivers Unacceptable Waste (as determined by Republic) Customer agrees to assume all expenses and obligations with the removal and/or resolution of any effects caused by the delivery of such Unacceptable Waste.

Indemnización. Cliente acuerda indemnizar, mantener inmune, y defender Republic Services, Inc., sus subsidiarios, compañías, divisiones, empleados, oficiales y directores contra de cualquiera y de todas responsabilidades, demandas, penas, pérdidas, juicios, pleitos y los costos incidente además, incluyendo costos de defensa, de acuerdo judicial, y de honorarios razonables del abogado, que pueden ser incurridos en, o como resultado de, la muerte o herida personal a cualquier persona, o daños a cualquier característica, propiedad, contaminación de la tierra o efectos ilícitos en esta Facilidad, causado entero o en parte por el cliente, sus empleados, o sus subcontratistas en botar basura en esta Facilidad. En el caso que el Cliente entrega, bota, basura (según lo determinado por Republic) en este Establecimiento basura inaceptable en los reglamentos de este Establecimiento, el Cliente se compromete asumir todos los costos y obligaciones con el retiro y/o la resolución de cualquier dano(s) causado por la entrega de tal basura inaceptable.



NON-HAZARDOUS WASTE MANIFEST

MANIFEST # 12114

GENERATOR INFORMATION

Generator Name: Tronox LLC

Address: P.O. Box 55

City: Henderson County: Clark

State: NV Zip: 89009

Site Location (if different): 560 W. Lake Mead

Henderson, NV 89015 (702) 592-7727

CUSTOMER/BILLING INFORMATION

Billing Name: NGE LLC c/o Northgate Environment Management

Address: 300 Frank Ogawa Plaza, Ste 510

City: Oakland County: Alameda

State: CA Zip: 94612

Republic Services Approval #	Description of Waste	Volume/Weight	Expiration Date	Container Type
38251011244	Soil for disposal		12-31-2011	Tractor with Dump Trailer(s)
	RZ- _____ # _____	35.10 m		

*Attach Additional Sheet if necessary

I hereby certify that the above-described materials are non-hazardous wastes as defined by 40 CFR 261 or any applicable state law. Further, that the above named materials are properly classified, described, packaged, marked and labeled, and are in proper condition for transportation according to the applicable regulations of the Department of Transportation.

Susan Crowley
Generator/Authorized Agent Name

Susan Crowley
Signature

Date Shipped

TRANSPORTER INFORMATION

Transporter Name: Las Vegas Paving

DOT # 191949

Address: 4420 S. Decatur

Truck Number: 2711

Las Vegas, NV 89103

Phone Number: (702) 353-4355

I certify no hazardous waste or other regulated substance was knowingly introduced to the waste while in my custody. The waste transported in this vehicle is the waste identified above, to the best of my knowledge.

STEVE HAYES
Name of Authorized Agent

Steve Hayes
Signature

10-7-10
Date Delivered

DISPOSAL SITE INFORMATION

Site Name: Apex Regional Landfill

Phone No. (702) 599-5920

Address: 13550 U.S. Hwy 93 Las Vegas, NV

I hereby acknowledge receipt of the above described materials

Jesse Smith
Name (Print or Type)

Jesse Smith
Signature

10-7-10
Date Received

81 Environmental Tech
13550 N Highway 93
Las Vegas, NV 89165

Ticket Type: INBOUND INVOICE

Ticket Number: 2027
Date: 10/07/2010
Time In: 10:35 pm
Time Out: 10:59 pm

Customer: 001011 - NGE, LLC c/o Northgate Environ Mgmt

Vehicle/Container: 35902A
Contract: Northgate Env. On Site Soils 3825 11
Comment: 071

Gross Weight: 126,100 LB Manual In
Tare Weight: 58,600 LB Manual Out
Net Weight: 67500 LB
Net Tons: 33.75

BOL: 12115

Origin	Yards	Material	Billing	Quantity
Not Applicable	0.00 YD	SW CONTAMINATED SOIL	33.75	TN

Driver: 

Weighmaster: 

SMITHJ

Indemnification. Customer agrees, by signature above, to indemnify, hold harmless, and defend Republic Services, Inc., its subsidiaries, affiliates, employees, officers and directors from and against any and all liabilities, claims, penalties, forfeitures, suits and the costs and expenses incident thereto, including costs of defense, settlement, and reasonable attorney's fees, which may be incurred, as a result of death or injuries to any person, or damage to any property, contamination of or adverse effects on the environment, caused in whole or in part by the Customer, its employees, or subcontractors in disposing waste at this Facility. In the event Customer delivers Unacceptable Waste (as determined by Republic) Customer agrees to assume all expenses and obligations with the removal and/or resolution of any effects caused by the delivery of such Unacceptable Waste.

Indemnización. Cliente acuerda indemnizar, mantener inmune, y defender Republic Services, Inc., sus subsidiarios, compañías, divisiones, empleados, oficiales y directores contra de cualquiera y de todas responsabilidades, demandas, penas, pérdidas, juicios, pleitos y los costos incidente además, incluyendo costos de defensa, de acuerdo judicial, y de honorarios razonables del abogado, que pueden ser incurridos en, o como resultado de, la muerte o herida personal a cualquier persona, o daños a cualquier característica, propiedad, contaminación de la tierra o efectos ilícitos en esta Facilidad, causado entero o en parte por el cliente, sus empleados, o sus subcontratistas en botar basura en esta Facilidad. En el caso que el Cliente entrega, bota, basura (según lo determinado por Republic) en este Establecimiento basura inaceptable en los reglamentos de este Establecimiento, el Cliente se compromete asumir todos los costos y obligaciones con el retiro y/o la resolución de cualquier dano(s) causado por la entrega de tal basura inaceptable.



NON-HAZARDOUS WASTE MANIFEST

MANIFEST # 12115

GENERATOR INFORMATION

Generator Name: Tronox LLCAddress: P.O. Box 55City: Henderson County: ClarkState: NV Zip: 89009Site Location (if different): 560 W. Lake MeadHenderson, NV 89015 (702) 592-7727

CUSTOMER/BILLING INFORMATION

Billing Name: NGE LLC c/o Northgate Environment ManagementAddress: 300 Frank Ogawa Plaza, Ste 510City: Oakland County: AlamedaState: CA Zip: 94612

Republic Services Approval #	Description of Waste	Volume/Weight	Expiration Date	Container Type
38251011244	Soil for disposal		12-31-2011	Tractor with Dump Trailer(s)
	RZ-_____ # _____			

*Attach Additional Sheet if necessary

I hereby certify that the above-described materials are non-hazardous wastes as defined by 40 CFR 261 or any applicable state law. Further, that the above named materials are properly classified, described, packaged, marked and labeled, and are in proper condition for transportation according to the applicable regulations of the Department of Transportation.

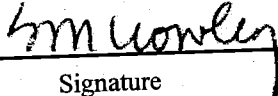
Susan Crowley 
 Generator/Authorized Agent Name Signature Date Shipped

TRANSPORTER INFORMATION

Transporter Name: Las Vegas PavingDOT # 191949Address: 4420 S. DecaturTruck Number: 071Las Vegas, NV 89103Phone Number: (702) 353-4355

I certify no hazardous waste or other regulated substance was knowingly introduced to the waste while in my custody. The waste transported in this vehicle is the waste identified above, to the best of my knowledge.

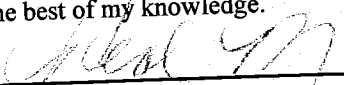
Ned M 
 Name of Authorized Agent Signature Date Delivered 10-7-10

DISPOSAL SITE INFORMATION

Site Name: Apex Regional LandfillPhone No. (702) 599-5920Address: 13550 U.S. Hwy 93 Las Vegas, NV

I hereby acknowledge receipt of the above described materials

Jose Sandoval 
 Name (Print or Type) Signature Date Received 10-7-10

81 Environmental Tech
13550 N Highway 93
Las Vegas, NV 89165

Ticket Type: INBOUND INVOICE

Ticket Number: 2028
Date: 10/07/2010
Time In: 11:03 pm
Time Out: 11:24 pm

Customer: 001011 - NGE, LLC c/o Northgate Environ Mgmt

Vehicle/Container: 44165A
Contract: Northgate Env. On Site Soils 3825 11
Comment: 3825 10 11244

Gross Weight: 129,320 LB Manual In
Tare Weight: 48,880 LB Manual Out
Net Weight: 80440 LB
Net Tons: 40.22

BOL: 12116

Origin	Yards	Material	Billing	Quantity
Not Applicable	0.00 YD	SW CONTAMINATED SOIL	40.22	TN

Driver:

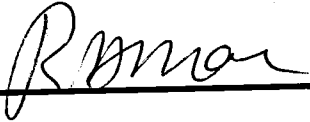

Weighmaster:

SMITHJ

Indemnification. Customer agrees, by signature above, to indemnify, hold harmless, and defend Republic Services, Inc., its subsidiaries, affiliates, employees, officers and directors from and against any and all liabilities, claims, penalties, forfeitures, suits and the costs and expenses incident thereto, including costs of defense, settlement, and reasonable attorney's fees, which may be incurred, as a result of death or injuries to any person, or damage to any property, contamination of or adverse effects on the environment, caused in whole or in part by the Customer, its employees, or subcontractors in disposing waste at this Facility. In the event Customer delivers Unacceptable Waste (as determined by Republic) Customer agrees to assume all expenses and obligations with the removal and/or resolution of any effects caused by the delivery of such Unacceptable Waste.

Indemnización. Cliente acuerda indemnizar, mantener inmune, y defender Republic Services, Inc., sus subsidiarios, compañías, divisiones, empleados, oficiales y directores contra de cualquiera y de todas responsabilidades, demandas, penas, pérdidas, juicios, pleitos y los costos incidente además, incluyendo costos de defensa, de acuerdo judicial, y de honorarios razonables del abogado, que pueden ser incurridos en, o como resultado de, la muerte o herida personal a cualquier persona, o daños a cualquier característica, propiedad, contaminación de la tierra o efectos ilícitos en esta Facilidad, causado entero o en parte por el cliente, sus empleados, o sus subcontratistas en botar basura en esta Facilidad. En el caso que el Cliente entrega, bota, basura (según lo determinado por Republic) en este Establecimiento basura inaceptable en los reglamentos de este Establecimiento, el Cliente se compromete asumir todos los costos y obligaciones con el retiro y/o la resolución de cualquier dano(s) causado por la entrega de tal basura inaceptable.



NON-HAZARDOUS WASTE MANIFEST

MANIFEST # 12116

GENERATOR INFORMATION

Generator Name: Tronox LLC

Address: P.O. Box 55

City: Henderson County: Clark

State: NV Zip: 89009

Site Location (if different): 560 W. Lake Mead

Henderson, NV 89015 (702) 592-7727

CUSTOMER/BILLING INFORMATION

Billing Name: NGE LLC c/o Northgate Environment Management

Address: 300 Frank Ogawa Plaza, Ste 510

City: Oakland County: Alameda

State: CA Zip: 94612

Republic Services Approval #	Description of Waste	Volume/Weight	Expiration Date	Container Type
38251011244	Soil for disposal		12-31-2011	Tractor with Dump Trailer(s)
	RZ- _____ # _____	40.22 TON		

*Attach Additional Sheet if necessary

I hereby certify that the above-described materials are non-hazardous wastes as defined by 40 CFR 261 or any applicable state law. Further, that the above named materials are properly classified, described, packaged, marked and labeled, and are in proper condition for transportation according to the applicable regulations of the Department of Transportation.

Susan Crowley [Signature] _____
 Generator/Authorized Agent Name Signature Date Shipped

TRANSPORTER INFORMATION

Transporter Name: Las Vegas Paving

DOT # 191949

Address: 4420 S. Decatur

Truck Number: K001

Las Vegas, NV 89103

Phone Number: (702) 353-4355

I certify no hazardous waste or other regulated substance was knowingly introduced to the waste while in my custody. The waste transported in this vehicle is the waste identified above, to the best of my knowledge.

[Signature] [Signature] 10-7-10
 Name of Authorized Agent Signature Date Delivered

DISPOSAL SITE INFORMATION

Site Name: Apex Regional Landfill

Phone No. (702) 599-5920

Address: 13550 U.S. Hwy 93 Las Vegas, NV

I hereby acknowledge receipt of the above described materials

[Signature] _____
 Name (Print or Type) Signature Date Received

81 Environmental Tech
13550 N Highway 93
Las Vegas, NV 89165

Ticket Type: INBOUND INVOICE

Ticket Number: 2029
Date: 10/07/2010
Time In: 11:06 pm
Time Out: 11:28 pm

Customer: 001011 - NGE, LLC c/o Northgate Environ Mgmt

Vehicle/Container: 86113P
Contract: Northgate Env. On Site Soils 3825 11
Comment: 3825 10 11244

Gross Weight: 136,440 LB Manual In
Tare Weight: 55,480 LB Manual Out
Net Weight: 80960 LB
Net Tons: 40.48

BOL: 12117

Origin	Yards	Material	Billing Quantity
Not Applicable	0.00 YD	SW CONTAMINATED SOIL	40.48 TN

Driver:

J. A. H.

Weighmaster:

SMITHJ

Indemnification. Customer agrees, by signature above, to indemnify, hold harmless, and defend Republic Services, Inc., its subsidiaries, affiliates, employees, officers and directors from and against any and all liabilities, claims, penalties, forfeitures, suits and the costs and expenses incident thereto, including costs of defense, settlement, and reasonable attorney's fees, which may be incurred, as a result of death or injuries to any person, or damage to any property, contamination of or adverse effects on the environment, caused in whole or in part by the Customer, its employees, or subcontractors in disposing waste at this Facility. In the event Customer delivers Unacceptable Waste (as determined by Republic) Customer agrees to assume all expenses and obligations with the removal and/or resolution of any effects caused by the delivery of such Unacceptable Waste.

Indemnización. Cliente acuerda indemnizar, mantener inmune, y defender Republic Services, Inc., sus subsidiarios, compañías, divisiones, empleados, oficiales y directores contra de cualquiera y de todas responsabilidades, demandas, penas, pérdidas, juicios, pleitos y los costos incidente además, incluyendo costos de defensa, de acuerdo judicial, y de honorarios razonables del abogado, que pueden ser incurridos en, o como resultado de, la muerte o herida personal a cualquier persona, o daños a cualquier característica, propiedad, contaminación de la tierra o efectos ilícitos en esta Facilidad, causado entero o en parte por el cliente, sus empleados, o sus subcontratistas en botar basura en esta Facilidad. En el caso que el Cliente entrega, bota, basura (según lo determinado por Republic) en este Establecimiento basura inaceptable en los reglamentos de este Establecimiento, el Cliente se compromete asumir todos los costos y obligaciones con el retiro y/o la resolución de cualquier dano(s) causado por la entrega de tal basura inaceptable.



NON-HAZARDOUS WASTE MANIFEST

MANIFEST # 12117

GENERATOR INFORMATION

Generator Name: Tronox LLC

Address: P.O. Box 55

City: Henderson County: Clark

State: NV Zip: 89009

Site Location (if different): 560 W. Lake Mead

Henderson, NV 89015 (702) 592-7727

CUSTOMER/BILLING INFORMATION

Billing Name: NGE LLC c/o Northgate Environment Management

Address: 300 Frank Ogawa Plaza, Ste 510

City: Oakland County: Alameda

State: CA Zip: 94612

Republic Services Approval #	Description of Waste	Volume/Weight	Expiration Date	Container Type
38251011244	Soil for disposal		12-31-2011	Tractor with Dump Trailer(s)
	RZ- _____ # _____	40.48 TN		

*Attach Additional Sheet if necessary

I hereby certify that the above-described materials are non-hazardous wastes as defined by 40 CFR 261 or any applicable state law. Further, that the above named materials are properly classified, described, packaged, marked and labeled, and are in proper condition for transportation according to the applicable regulations of the Department of Transportation.

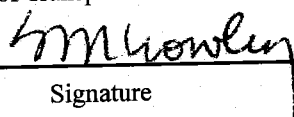
Susan Crowley 
 Generator/Authorized Agent Name Signature Date Shipped

TRANSPORTER INFORMATION

Transporter Name: Las Vegas Paving

DOT # 191949

Address: 4420 S. Decatur

Truck Number: R0019/7

Las Vegas, NV 89103

Phone Number: (702) 353-4355

I certify no hazardous waste or other regulated substance was knowingly introduced to the waste while in my custody. The waste transported in this vehicle is the waste identified above, to the best of my knowledge.

ALBERTO 
 Name of Authorized Agent Signature Date Delivered OCT 7, 2010

DISPOSAL SITE INFORMATION

Site Name: Apex Regional Landfill

Phone No. (702) 599-5920

Address: 13550 U.S. Hwy 93 Las Vegas, NV

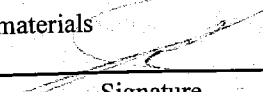
I hereby acknowledge receipt of the above described materials
Jose C. Sanchez 
 Name (Print or Type) Signature Date Received 10/7/10

81 Environmental Tech
13550 N Highway 93
Las Vegas, NV 89165

Ticket Type: INBOUND INVOICE

Ticket Number: 2030
Date: 10/07/2010
Time In: 11:11 pm
Time Out: 11:39 pm

Customer: 001011 - NGE, LLC c/o Northgate Environ Mgmt

Vehicle/Container: 85887P
Contract: Northgate Env. On Site Soils 3825 11
Comment: 3825 10 11244

Gross Weight: 129,400 LB Manual In
Tare Weight: 51,920 LB Manual Out
Net Weight: 77480 LB
Net Tons: 38.74

BOL: 12118

Origin	Yards	Material	Billing Quantity
Not Applicable	0.00 YD	SW CONTAMINATED SOIL	38.74 TN

Driver:

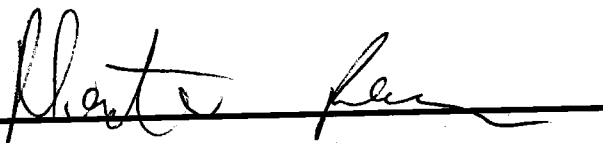

Weighmaster:

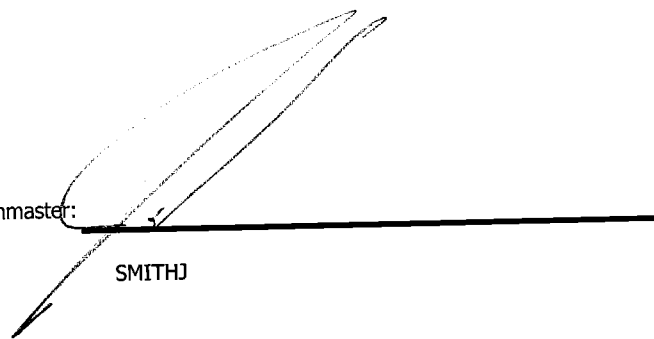

SMITHJ

Indemnification. Customer agrees, by signature above, to indemnify, hold harmless, and defend Republic Services, Inc., its subsidiaries, affiliates, employees, officers and directors from and against any and all liabilities, claims, penalties, forfeitures, suits and the costs and expenses incident thereto, including costs of defense, settlement, and reasonable attorney's fees, which may be incurred, as a result of death or injuries to any person, or damage to any property, contamination of or adverse effects on the environment, caused in whole or in part by the Customer, its employees, or subcontractors in disposing waste at this Facility. In the event Customer delivers Unacceptable Waste (as determined by Republic) Customer agrees to assume all expenses and obligations with the removal and/or resolution of any effects caused by the delivery of such Unacceptable Waste.

Indemnización. Cliente acuerda indemnizar, mantener inmune, y defender Republic Services, Inc., sus subsidiarios, compañías, divisiones, empleados, oficiales y directores contra de cualquiera y de todas responsabilidades, demandas, penas, pérdidas, juicios, pleitos y los costos incidente además, incluyendo costos de defensa, de acuerdo judicial, y de honorarios razonables del abogado, que pueden ser incurridos en, o como resultado de, la muerte o herida personal a cualquier persona, o daños a cualquier característica, propiedad, contaminación de la tierra o efectos ilícitos en esta Facilidad, causado entero o en parte por el cliente, sus empleados, o sus subcontratistas en botar basura en esta Facilidad. En el caso que el Cliente entrega, bota, basura (según lo determinado por Republic) en este Establecimiento basura inaceptable en los reglamentos de este Establecimiento, el Cliente se compromete asumir todos los costos y obligaciones con el retiro y/o la resolución de cualquier dano(s) causado por la entrega de tal basura inaceptable.



NON-HAZARDOUS WASTE MANIFEST

MANIFEST # 12118

GENERATOR INFORMATION

Generator Name: Tronox LLC

Address: P.O. Box 55

City: Henderson County: Clark

State: NV Zip: 89009

Site Location (if different): 560 W. Lake Mead
Henderson, NV 89015 (702) 592-7727

CUSTOMER/BILLING INFORMATION

Billing Name: NGE LLC c/o Northgate Environment Management

Address: 300 Frank Ogawa Plaza, Ste 510

City: Oakland County: Alameda

State: CA Zip: 94612

Table with 5 columns: Republic Services Approval #, Description of Waste, Volume/Weight, Expiration Date, Container Type. Row 1: 38251011244, Soil for disposal, 38.74 TON, 12-31-2011, Tractor with Dump Trailer(s).

*Attach Additional Sheet if necessary

I hereby certify that the above-described materials are non-hazardous wastes as defined by 40 CFR 261 or any applicable state law. Further, that the above named materials are properly classified, described, packaged, marked and labeled, and are in proper condition for transportation according to the applicable regulations of the Department of Transportation.

Susan Crowley
Generator/Authorized Agent Name Signature Date Shipped

TRANSPORTER INFORMATION

Transporter Name: Las Vegas Paving

DOT # 191949

Address: 4420 S. Decatur

Truck Number: R01

Las Vegas, NV 89103

Phone Number: (702) 353-4355

I certify no hazardous waste or other regulated substance was knowingly introduced to the waste while in my custody. The waste transported in this vehicle is the waste identified above, to the best of my knowledge.

Name of Authorized Agent Signature Date Delivered

DISPOSAL SITE INFORMATION

Site Name: Apex Regional Landfill

Phone No. (702) 599-5920

Address: 13550 U.S. Hwy 93 Las Vegas, NV

I hereby acknowledge receipt of the above described materials

Name (Print or Type) Signature Date Received

81 Environmental Tech
13550 N Highway 93
Las Vegas, NV 89165

Ticket Type: INBOUND INVOICE

Ticket Number: 2031
Date: 10/07/2010
Time In: 11:14 pm
Time Out: 11:39 pm

Customer: 001011 - NGE, LLC c/o Northgate Environ Mgmt

Vehicle/Container: 44564A
Contract: Northgate Env. On Site Soils 3825 11
Comment: 3825 10 11244

Gross Weight: 134,080 LB Manual In
Tare Weight: 49,440 LB Manual Out
Net Weight: 84640 LB
Net Tons: 42.32

BOL: 12119

Origin	Yards	Material	Billing Quantity
Not Applicable	0.00 YD	SW CONTAMINATED SOIL	42.32 TN

Driver:

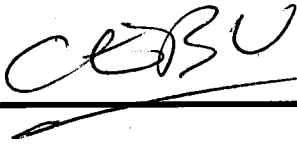

Weighmaster:

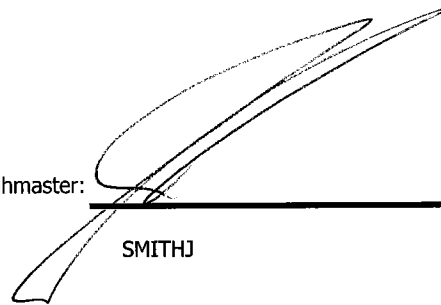

SMITHJ

Indemnification. Customer agrees, by signature above, to indemnify, hold harmless, and defend Republic Services, Inc., its subsidiaries, affiliates, employees, officers and directors from and against any and all liabilities, claims, penalties, forfeitures, suits and the costs and expenses incident thereto, including costs of defense, settlement, and reasonable attorney's fees, which may be incurred, as a result of death or injuries to any person, or damage to any property, contamination of or adverse effects on the environment, caused in whole or in part by the Customer, its employees, or subcontractors in disposing waste at this Facility. In the event Customer delivers Unacceptable Waste (as determined by Republic) Customer agrees to assume all expenses and obligations with the removal and/or resolution of any effects caused by the delivery of such Unacceptable Waste.

Indemnización. Cliente acuerda indemnizar, mantener inmune, y defender Republic Services, Inc., sus subsidiarios, compañías, divisiones, empleados, oficiales y directores contra de cualquiera y de todas responsabilidades, demandas, penas, pérdidas, juicios, pleitos y los costos incidente además, incluyendo costos de defensa, de acuerdo judicial, y de honorarios razonables del abogado, que pueden ser incurridos en, o como resultado de, la muerte o herida personal a cualquier persona, o daños a cualquier característica, propiedad, contaminación de la tierra o efectos ilícitos en esta Facilidad, causado entero o en parte por el cliente, sus empleados, o sus subcontratistas en botar basura en esta Facilidad. En el caso que el Cliente entrega, bota, basura (según lo determinado por Republic) en este Establecimiento basura inaceptable en los reglamentos de este Establecimiento, el Cliente se compromete asumir todos los costos y obligaciones con el retiro y/o la resolución de cualquier dano(s) causado por la entrega de tal basura inaceptable.



NON-HAZARDOUS WASTE MANIFEST

MANIFEST # 12119

GENERATOR INFORMATION

Generator Name: Tronox LLC

Address: P.O. Box 55

City: Henderson County: Clark

State: NV Zip: 89009

Site Location (if different): 560 W. Lake Mead

Henderson, NV 89015 (702) 592-7727

CUSTOMER/BILLING INFORMATION

Billing Name: NGE LLC c/o Northgate Environment Management

Address: 300 Frank Ogawa Plaza, Ste 510

City: Oakland County: Alameda

State: CA Zip: 94612

Table with 5 columns: Republic Services Approval #, Description of Waste, Volume/Weight, Expiration Date, Container Type. Row 1: 38251011244, Soil for disposal, 42.32 TN, 12-31-2011, Tractor with Dump Trailer(s).

*Attach Additional Sheet if necessary

I hereby certify that the above-described materials are non-hazardous wastes as defined by 40 CFR 261 or any applicable state law. Further, that the above named materials are properly classified, described, packaged, marked and labeled, and are in proper condition for transportation according to the applicable regulations of the Department of Transportation.

Susan Crowley (Signature) Generator/Authorized Agent Name Signature Date Shipped

TRANSPORTER INFORMATION

Transporter Name: Las Vegas Paving

DOT # 191949

Address: 4420 S. Decatur

Truck Number: K003

Las Vegas, NV 89103

Phone Number: (702) 353-4355

I certify no hazardous waste or other regulated substance was knowingly introduced to the waste while in my custody. The waste transported in this vehicle is the waste identified above, to the best of my knowledge.

CEBU (Signature) CEBU (Signature) 10/07/10 Date Delivered

DISPOSAL SITE INFORMATION

Site Name: Apex Regional Landfill

Phone No. (702) 599-5920

Address: 13550 U.S. Hwy 93 Las Vegas, NV

I hereby acknowledge receipt of the above described materials

Jesse Smith (Signature) Name (Print or Type) Signature Date Received 10-7-10

81 Environmental Tech
13550 N Highway 93
Las Vegas, NV 89165

Ticket Type: INBOUND INVOICE

Ticket Number: 2032
Date: 10/07/2010
Time In: 11:27 pm
Time Out: 11:53 pm

Customer: 001011 - NGE, LLC c/o Northgate Environ Mgmt

Vehicle/Container: 192456
Contract: Northgate Env. On Site Soils 3825 11
Comment: 3825 10 11244

Gross Weight: 128,820 LB Manual In
Tare Weight: 53,100 LB Manual Out
Net Weight: 75720 LB
Net Tons: 37.86

BOL: 12121

Origin	Yards	Material	Billing	Quantity
Not Applicable	0.00 YD	SW CONTAMINATED SOIL	37.86	TN

Driver: _____

Weighmaster: _____

SMITHJ

Indemnification. Customer agrees, by signature above, to indemnify, hold harmless, and defend Republic Services, Inc., its subsidiaries, affiliates, employees, officers and directors from and against any and all liabilities, claims, penalties, forfeitures, suits and the costs and expenses incident thereto, including costs of defense, settlement, and reasonable attorney's fees, which may be incurred, as a result of death or injuries to any person, or damage to any property, contamination of or adverse effects on the environment, caused in whole or in part by the Customer, its employees, or subcontractors in disposing waste at this Facility. In the event Customer delivers Unacceptable Waste (as determined by Republic) Customer agrees to assume all expenses and obligations with the removal and/or resolution of any effects caused by the delivery of such Unacceptable Waste.

Indemnización. Cliente acuerda indemnizar, mantener inmune, y defender Republic Services, Inc., sus subsidiarios, compañías, divisiones, empleados, oficiales y directores contra de cualquiera y de todas responsabilidades, demandas, penas, pérdidas, juicios, pleitos y los costos incidente además, incluyendo costos de defensa, de acuerdo judicial, y de honorarios razonables del abogado, que pueden ser incurridos en, o como resultado de, la muerte o herida personal a cualquier persona, o daños a cualquier característica, propiedad, contaminación de la tierra o efectos ilícitos en esta Facilidad, causado entero o en parte por el cliente, sus empleados, o sus subcontratistas en botar basura en esta Facilidad. En el caso que el Cliente entrega, bota, basura (según lo determinado por Republic) en este Establecimiento basura inaceptable en los reglamentos de este Establecimiento, el Cliente se compromete asumir todos los costos y obligaciones con el retiro y/o la resolución de cualquier dano(s) causado por la entrega de tal basura inaceptable.



NON-HAZARDOUS WASTE MANIFEST

MANIFEST # 12121

GENERATOR INFORMATION

Generator Name: Tronox LLC
Address: P.O. Box 55
City: Henderson County: Clark
State: NV Zip: 89009
Site Location (if different): 560 W. Lake Mead
Henderson, NV 89015 (702) 592-7727

CUSTOMER/BILLING INFORMATION

Billing Name: NGE LLC c/o Northgate Environment Management
Address: 300 Frank Ogawa Plaza, Ste 510
City: Oakland County: Alameda
State: CA Zip: 94612

Table with 5 columns: Republic Services Approval #, Description of Waste, Volume/Weight, Expiration Date, Container Type. Row 1: 38251011244, Soil for disposal, 37.86 TN, 12-31-2011, Tractor with Dump Trailer(s).

*Attach Additional Sheet if necessary

I hereby certify that the above-described materials are non-hazardous wastes as defined by 40 CFR 261 or any applicable state law. Further, that the above named materials are properly classified, described, packaged, marked and labeled, and are in proper condition for transportation according to the applicable regulations of the Department of Transportation.

Susan Crowley
Generator/Authorized Agent Name Signature Date Shipped

TRANSPORTER INFORMATION

Transporter Name: Las Vegas Paving DOT # 191949
Address: 4420 S. Decatur Truck Number: 192456
Las Vegas, NV 89103 Phone Number: (702) 353-4355

I certify no hazardous waste or other regulated substance was knowingly introduced to the waste while in my custody. The waste transported in this vehicle is the waste identified above, to the best of my knowledge.

Name of Authorized Agent Signature Date Delivered 10/7/10

DISPOSAL SITE INFORMATION

Site Name: Apex Regional Landfill Phone No. (702) 599-5920
Address: 13550 U.S. Hwy 93 Las Vegas, NV

I hereby acknowledge receipt of the above described materials
Name (Print or Type) Signature Date Received 10-7-10

81 Environmental Tech
13550 N Highway 93
Las Vegas, NV 89165

Ticket Type: INBOUND INVOICE

Ticket Number: 2033
Date: 10/07/2010
Time In: 11:33 pm
Time Out: 11:58 pm

Customer: 001011 - NGE, LLC c/o Northgate Environ Mgmt

Vehicle/Container: 44166A
Contract: Northgate Env. On Site Soils 3825 11
Comment: 002

Gross Weight: 138,360 LB Manual In
Tare Weight: 57,420 LB Manual Out
Net Weight: 80940 LB
Net Tons: 40.47

BOL: 12120

Origin	Yards	Material	Billing	Quantity
Not Applicable	0.00 YD	SW CONTAMINATED SOIL	40.47	TN

Driver: _____



Weighmaster: _____

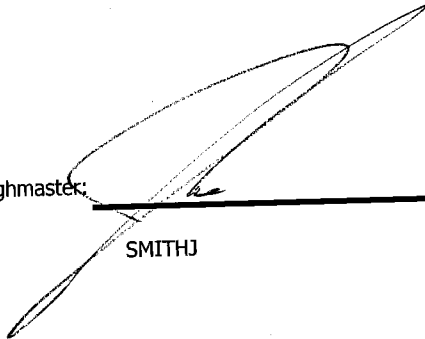

SMITHJ

Indemnification. Customer agrees, by signature above, to indemnify, hold harmless, and defend Republic Services, Inc., its subsidiaries, affiliates, employees, officers and directors from and against any and all liabilities, claims, penalties, forfeitures, suits and the costs and expenses incident thereto, including costs of defense, settlement, and reasonable attorney's fees, which may be incurred, as a result of death or injuries to any person, or damage to any property, contamination of or adverse effects on the environment, caused in whole or in part by the Customer, its employees, or subcontractors in disposing waste at this Facility. In the event Customer delivers Unacceptable Waste (as determined by Republic) Customer agrees to assume all expenses and obligations with the removal and/or resolution of any effects caused by the delivery of such Unacceptable Waste.

Indemnización. Cliente acuerda indemnizar, mantener inmune, y defender Republic Services, Inc., sus subsidiarios, compañías, divisiones, empleados, oficiales y directores contra de cualquiera y de todas responsabilidades, demandas, penas, pérdidas, juicios, pleitos y los costos incidente además, incluyendo costos de defensa, de acuerdo judicial, y de honorarios razonables del abogado, que pueden ser incurridos en, o como resultado de, la muerte o herida personal a cualquier persona, o daños a cualquier característica, propiedad, contaminación de la tierra o efectos ilícitos en esta Facilidad, causado entero o en parte por el cliente, sus empleados, o sus subcontratistas en botar basura en esta Facilidad. En el caso que el Cliente entrega, bota, basura (según lo determinado por Republic) en este Establecimiento basura inaceptable en los reglamentos de este Establecimiento, el Cliente se compromete asumir todos los costos y obligaciones con el retiro y/o la resolución de cualquier dano(s) causado por la entrega de tal basura inaceptable.



NON-HAZARDOUS WASTE MANIFEST

MANIFEST # 12120

GENERATOR INFORMATION

Generator Name: Tronox LLC

Address: P.O. Box 55

City: Henderson County: Clark

State: NV Zip: 89009

Site Location (if different): 560 W. Lake Mead

Henderson, NV 89015 (702) 592-7727

CUSTOMER/BILLING INFORMATION

Billing Name: NGE LLC c/o Northgate Environment Management

Address: 300 Frank Ogawa Plaza, Ste 510

City: Oakland County: Alameda

State: CA Zip: 94612

Republic Services Approval #	Description of Waste	Volume/Weight	Expiration Date	Container Type
38251011244	Soil for disposal		12-31-2011	Tractor with Dump Trailer(s)
	RZ- #	46.47 TON		

*Attach Additional Sheet if necessary

I hereby certify that the above-described materials are non-hazardous wastes as defined by 40 CFR 261 or any applicable state law. Further, that the above named materials are properly classified, described, packaged, marked and labeled, and are in proper condition for transportation according to the applicable regulations of the Department of Transportation.

Susan Crowley Generator/Authorized Agent Name Signature Date Shipped

TRANSPORTER INFORMATION

Transporter Name: Las Vegas Paving

DOT # 191949

Address: 4420 S. Decatur

Truck Number: K002

Las Vegas, NV 89103

Phone Number: (702) 353-4355

I certify no hazardous waste or other regulated substance was knowingly introduced to the waste while in my custody. The waste transported in this vehicle is the waste identified above, to the best of my knowledge.

Name of Authorized Agent Signature Date Delivered

DISPOSAL SITE INFORMATION

Site Name: Apex Regional Landfill

Phone No. (702) 599-5920

Address: 13550 U.S. Hwy 93 Las Vegas, NV

I hereby acknowledge receipt of the above described materials

Name (Print or Type) Signature Date Received

81 Environmental Tech
13550 N Highway 93
Las Vegas, NV 89165

Ticket Type: INBOUND INVOICE

Ticket Number: 2034
Date: 10/07/2010
Time In: 11:34 pm
Time Out: 12:00 am

Customer: 001011 - NGE, LLC c/o Northgate Environ Mgmt

Vehicle/Container: 192460
Contract: Northgate Env. On Site Soils 3825 11
Comment: 3825 10 11244

Gross Weight: 127,980 LB Manual In
Tare Weight: 53,400 LB Manual Out
Net Weight: 74,580 LB
Net Tons: 37.29

BOL: 12123

Origin	Yards	Material	Billing	Quantity
Not Applicable	0.00 YD	SW CONTAMINATED SOIL	37.29	TN

Driver:

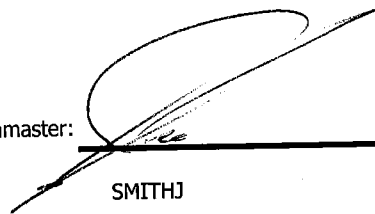

Weighmaster:

SMITHJ

Indemnification. Customer agrees, by signature above, to indemnify, hold harmless, and defend Republic Services, Inc., its subsidiaries, affiliates, employees, officers and directors from and against any and all liabilities, claims, penalties, forfeitures, suits and the costs and expenses incident thereto, including costs of defense, settlement, and reasonable attorney's fees, which may be incurred, as a result of death or injuries to any person, or damage to any property, contamination of or adverse effects on the environment, caused in whole or in part by the Customer, its employees, or subcontractors in disposing waste at this Facility. In the event Customer delivers Unacceptable Waste (as determined by Republic) Customer agrees to assume all expenses and obligations with the removal and/or resolution of any effects caused by the delivery of such Unacceptable Waste.

Indemnización. Cliente acuerda indemnizar, mantener inmune, y defender Republic Services, Inc., sus subsidiarios, compañías, divisiones, empleados, oficiales y directores contra de cualquiera y de todas responsabilidades, demandas, penas, pérdidas, juicios, pleitos y los costos incidente además, incluyendo costos de defensa, de acuerdo judicial, y de honorarios razonables del abogado, que pueden ser incurridos en, o como resultado de, la muerte o herida personal a cualquier persona, o daños a cualquier característica, propiedad, contaminación de la tierra o efectos ilícitos en esta Facilidad, causado entero o en parte por el cliente, sus empleados, o sus subcontratistas en botar basura en esta Facilidad. En el caso que el Cliente entrega, bota, basura (según lo determinado por Republic) en este Establecimiento basura inaceptable en los reglamentos de este Establecimiento, el Cliente se compromete asumir todos los costos y obligaciones con el retiro y/o la resolución de cualquier dano(s) causado por la entrega de tal basura inaceptable.



NON-HAZARDOUS WASTE MANIFEST

MANIFEST # 12123

GENERATOR INFORMATION

Generator Name: Tronox LLC

Address: P.O. Box 55

City: Henderson County: Clark

State: NV Zip: 89009

Site Location (if different): 560 W. Lake Mead

Henderson, NV 89015 (702) 592-7727

CUSTOMER/BILLING INFORMATION

Billing Name: NGE LLC c/o Northgate Environment Management

Address: 300 Frank Ogawa Plaza, Ste 510

City: Oakland County: Alameda

State: CA Zip: 94612

Republic Services Approval #	Description of Waste	Volume/Weight	Expiration Date	Container Type
38251011244	Soil for disposal		12-31-2011	Tractor with Dump Trailer(s)
	RZ- _____ # _____	37.24 TON		

*Attach Additional Sheet if necessary

I hereby certify that the above-described materials are non-hazardous wastes as defined by 40 CFR 261 or any applicable state law. Further, that the above named materials are properly classified, described, packaged, marked and labeled, and are in proper condition for transportation according to the applicable regulations of the Department of Transportation.

Susan Crowley
Generator/Authorized Agent Name

Susan Crowley
Signature

Date Shipped

TRANSPORTER INFORMATION

Transporter Name: Las Vegas Paving

DOT # 191949

Address: 4420 S. Decatur

Truck Number: 2460

Las Vegas, NV 89103

Phone Number: (702) 353-4355

I certify no hazardous waste or other regulated substance was knowingly introduced to the waste while in my custody. The waste transported in this vehicle is the waste identified above, to the best of my knowledge.

Greg Honish
Name of Authorized Agent

Greg Honish
Signature

10-7-10
Date Delivered

DISPOSAL SITE INFORMATION

Site Name: Apex Regional Landfill

Phone No. (702) 599-5920

Address: 13550 U.S. Hwy 93 Las Vegas, NV

I hereby acknowledge receipt of the above described materials

Lisa Smith
Name (Print or Type)

Lisa Smith
Signature

10-7-10
Date Received

81 Environmental Tech
13550 N Highway 93
Las Vegas, NV 89165

Ticket Type: INBOUND INVOICE

Ticket Number: 2035
Date: 10/07/2010
Time In: 11:34 pm
Time Out: 12:02 am

Customer: 001011 - NGE, LLC c/o Northgate Environ Mgmt

Vehicle/Container: 192457
Contract: Northgate Env. On Site Soils 3825 11
Comment: 3825 10 11244

Gross Weight: 127,620 LB Manual In
Tare Weight: 52,180 LB Manual Out
Net Weight: 75440 LB
Net Tons: 37.72

BOL: 12122

Origin	Yards	Material	Billing Quantity
Not Applicable	0.00 YD	SW CONTAMINATED SOIL	37.72 TN

Driver:

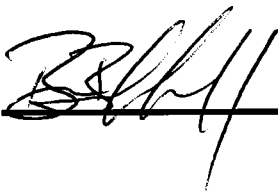

Weighmaster:

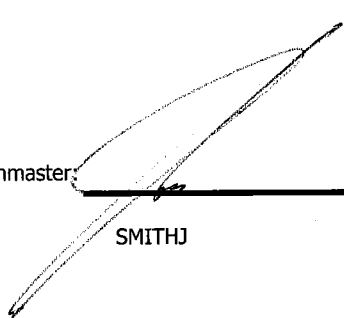

SMITHJ

Indemnification. Customer agrees, by signature above, to indemnify, hold harmless, and defend Republic Services, Inc., its subsidiaries, affiliates, employees, officers and directors from and against any and all liabilities, claims, penalties, forfeitures, suits and the costs and expenses incident thereto, including costs of defense, settlement, and reasonable attorney's fees, which may be incurred, as a result of death or injuries to any person, or damage to any property, contamination of or adverse effects on the environment, caused in whole or in part by the Customer, its employees, or subcontractors in disposing waste at this Facility. In the event Customer delivers Unacceptable Waste (as determined by Republic) Customer agrees to assume all expenses and obligations with the removal and/or resolution of any effects caused by the delivery of such Unacceptable Waste.

Indemnización. Cliente acuerda indemnizar, mantener inmune, y defender Republic Services, Inc., sus subsidiarios, compañías, divisiones, empleados, oficiales y directores contra de cualquiera y de todas responsabilidades, demandas, penas, pérdidas, juicios, pleitos y los costos incidente además, incluyendo costos de defensa, de acuerdo judicial, y de honorarios razonables del abogado, que pueden ser incurridos en, o como resultado de, la muerte o herida personal a cualquier persona, o daños a cualquier característica, propiedad, contaminación de la tierra o efectos ilícitos en esta Facilidad, causado entero o en parte por el cliente, sus empleados, o sus subcontratistas en botar basura en esta Facilidad. En el caso que el Cliente entrega, bota, basura (según lo determinado por Republic) en este Establecimiento basura inaceptable en los reglamentos de este Establecimiento, el Cliente se compromete asumir todos los costos y obligaciones con el retiro y/o la resolución de cualquier dano(s) causado por la entrega de tal basura inaceptable.



NON-HAZARDOUS WASTE MANIFEST

MANIFEST # 12122

GENERATOR INFORMATION

Generator Name: Tronox LLCAddress: P.O. Box 55City: Henderson County: ClarkState: NV Zip: 89009Site Location (if different): 560 W. Lake Mead
Henderson, NV 89015 (702) 592-7727

CUSTOMER/BILLING INFORMATION

Billing Name: NGE LLC c/o Northgate Environment ManagementAddress: 300 Frank Ogawa Plaza, Ste 510City: Oakland County: AlamedaState: CA Zip: 94612

Republic Services Approval #	Description of Waste	Volume/Weight	Expiration Date	Container Type
38251011244	Soil for disposal		12-31-2011	Tractor with Dump Trailer(s)
	RZ- _____ # _____	37.72 ¹⁰⁰		

*Attach Additional Sheet if necessary

I hereby certify that the above-described materials are non-hazardous wastes as defined by 40 CFR 261 or any applicable state law. Further, that the above named materials are properly classified, described, packaged, marked and labeled, and are in proper condition for transportation according to the applicable regulations of the Department of Transportation.

Susan Crowley
Generator/Authorized Agent Name

[Signature]
Signature

Date Shipped

TRANSPORTER INFORMATION

Transporter Name: Las Vegas PavingDOT # 191949Address: 4420 S. DecaturTruck Number: 192457Las Vegas, NV 89103Phone Number: (702) 353-4355

I certify no hazardous waste or other regulated substance was knowingly introduced to the waste while in my custody. The waste transported in this vehicle is the waste identified above, to the best of my knowledge.

Brian Brinkerhoff
Name of Authorized Agent

[Signature]
Signature

10-7-10
Date Delivered

DISPOSAL SITE INFORMATION

Site Name: Apex Regional LandfillPhone No. (702) 599-5920Address: 13550 U.S. Hwy 93 Las Vegas, NV

I hereby acknowledge receipt of the above described materials

[Signature]
Name (Print or Type)

Signature

10/7/10
Date Received

81 Environmental Tech
13550 N Highway 93
Las Vegas, NV 89165

Ticket Type: INBOUND INVOICE

Ticket Number: 2036
Date: 10/07/2010
Time In: 11:57 pm
Time Out: 12:19 am

Customer: 001011 - NGE, LLC c/o Northgate Environ Mgmt

Vehicle/Container: 81495P
Contract: Northgate Env. On Site Soils 3825 11
Comment: 3825 10 11244

Gross Weight: 121,380 LB Manual In
Tare Weight: 51,440 LB Manual Out
Net Weight: 69940 LB
Net Tons: 34.97

BOL: 12124

Origin	Yards	Material	Billing	Quantity
Not Applicable	0.00 YD	SW CONTAMINATED SOIL	34.97	TN

Driver: _____



Weighmaster: _____

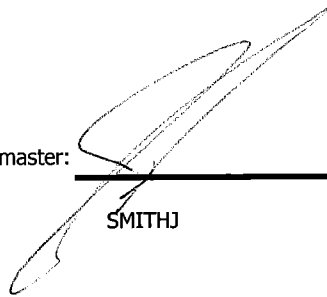

SMITHJ

Indemnification. Customer agrees, by signature above, to indemnify, hold harmless, and defend Republic Services, Inc., its subsidiaries, affiliates, employees, officers and directors from and against any and all liabilities, claims, penalties, forfeitures, suits and the costs and expenses incident thereto, including costs of defense, settlement, and reasonable attorney's fees, which may be incurred, as a result of death or injuries to any person, or damage to any property, contamination of or adverse effects on the environment, caused in whole or in part by the Customer, its employees, or subcontractors in disposing waste at this Facility. In the event Customer delivers Unacceptable Waste (as determined by Republic) Customer agrees to assume all expenses and obligations with the removal and/or resolution of any effects caused by the delivery of such Unacceptable Waste.

Indemnización. Cliente acuerda indemnizar, mantener inmune, y defender Republic Services, Inc., sus subsidiarios, compañías, divisiones, empleados, oficiales y directores contra de cualquiera y de todas responsabilidades, demandas, penas, pérdidas, juicios, pleitos y los costos incidente además, incluyendo costos de defensa, de acuerdo judicial, y de honorarios razonables del abogado, que pueden ser incurridos en, o como resultado de, la muerte o herida personal a cualquier persona, o daños a cualquier característica, propiedad, contaminación de la tierra o efectos ilícitos en esta Facilidad, causado entero o en parte por el cliente, sus empleados, o sus subcontratistas en botar basura en esta Facilidad. En el caso que el Cliente entrega, bota, basura (según lo determinado por Republic) en este Establecimiento basura inaceptable en los reglamentos de este Establecimiento, el Cliente se compromete asumir todos los costos y obligaciones con el retiro y/o la resolución de cualquier dano(s) causado por la entrega de tal basura inaceptable.



SR 40238

NON-HAZARDOUS WASTE MANIFEST

MANIFEST # 12124

GENERATOR INFORMATION

Generator Name: Tronox LLC
Address: P.O. Box 55
City: Henderson County: Clark
State: NV Zip: 89009
Site Location (if different): 560 W. Lake Mead
Henderson, NV 89015 (702) 592-7727

CUSTOMER/BILLING INFORMATION

Billing Name: NGE LLC c/o Northgate Environment Management
Address: 300 Frank Ogawa Plaza, Ste 510
City: Oakland County: Alameda
State: CA Zip: 94612

Table with 5 columns: Republic Services Approval #, Description of Waste, Volume/Weight, Expiration Date, Container Type. Row 1: 38251011244, Soil for disposal, 34.97 TW, 12-31-2011, Tractor with Dump Trailer(s)

*Attach Additional Sheet if necessary

I hereby certify that the above-described materials are non-hazardous wastes as defined by 40 CFR 261 or any applicable state law. Further, that the above named materials are properly classified, described, packaged, marked and labeled, and are in proper condition for transportation according to the applicable regulations of the Department of Transportation.

Susan Crowley
Generator/Authorized Agent Name Signature Date Shipped

TRANSPORTER INFORMATION

Transporter Name: Las Vegas Paving DOT # 191949
Address: 4420 S. Decatur Truck Number: 175
Las Vegas, NV 89103 Phone Number: (702) 353-4355

I certify no hazardous waste or other regulated substance was knowingly introduced to the waste while in my custody. The waste transported in this vehicle is the waste identified above, to the best of my knowledge.
Larry Harnsberger Signature Date Delivered 10-7-10

DISPOSAL SITE INFORMATION

Site Name: Apex Regional Landfill Phone No. (702) 599-5920
Address: 13550 U.S. Hwy 93 Las Vegas, NV

I hereby acknowledge receipt of the above described materials
Name (Print or Type) Signature Date Received 10-7-10

81 Environmental Tech
13550 N Highway 93
Las Vegas, NV 89165

Ticket Type: INBOUND INVOICE

Ticket Number: 2037
Date: 10/08/2010
Time In: 12:02 am
Time Out: 12:21 am

Customer: 001011 - NGE, LLC c/o Northgate Environ Mgmt

Vehicle/Container: 35903A
Contract: Northgate Env. On Site Soils 3825 11
Comment: 3825 10 11244

Gross Weight: 122,640 LB Manual In
Tare Weight: 57,840 LB Manual Out
Net Weight: 64800 LB
Net Tons: 32.40

BOL: 12126

Origin	Yards	Material	Billing	Quantity
Not Applicable	0.00 YD	SW CONTAMINATED SOIL	32.40	TN

Driver:

JAY MASON

Weighmaster:

SMITHJ

Indemnification. Customer agrees, by signature above, to indemnify, hold harmless, and defend Republic Services, Inc., its subsidiaries, affiliates, employees, officers and directors from and against any and all liabilities, claims, penalties, forfeitures, suits and the costs and expenses incident thereto, including costs of defense, settlement, and reasonable attorney's fees, which may be incurred, as a result of death or injuries to any person, or damage to any property, contamination of or adverse effects on the environment, caused in whole or in part by the Customer, its employees, or subcontractors in disposing waste at this Facility. In the event Customer delivers Unacceptable Waste (as determined by Republic) Customer agrees to assume all expenses and obligations with the removal and/or resolution of any effects caused by the delivery of such Unacceptable Waste.

Indemnización. Cliente acuerda indemnizar, mantener inmune, y defender Republic Services, Inc., sus subsidiarios, compañías, divisiones, empleados, oficiales y directores contra de cualquiera y de todas responsabilidades, demandas, penas, pérdidas, juicios, pleitos y los costos incidente además, incluyendo costos de defensa, de acuerdo judicial, y de honorarios razonables del abogado, que pueden ser incurridos en, o como resultado de, la muerte o herida personal a cualquier persona, o daños a cualquier característica, propiedad, contaminación de la tierra o efectos ilícitos en esta Facilidad, causado entero o en parte por el cliente, sus empleados, o sus subcontratistas en botar basura en esta Facilidad. En el caso que el Cliente entrega, bota, basura (según lo determinado por Republic) en este Establecimiento basura inaceptable en los reglamentos de este Establecimiento, el Cliente se compromete asumir todos los costos y obligaciones con el retiro y/o la resolución de cualquier dano(s) causado por la entrega de tal basura inaceptable.



NON-HAZARDOUS WASTE MANIFEST

MANIFEST # 12126

GENERATOR INFORMATION

Generator Name: Tronox LLC

Address: P.O. Box 55

City: Henderson County: Clark

State: NV Zip: 89009

Site Location (if different): 560 W. Lake Mead

Henderson, NV 89015 (702) 592-7727

CUSTOMER/BILLING INFORMATION

Billing Name: NGE LLC c/o Northgate Environment Management

Address: 300 Frank Ogawa Plaza, Ste 510

City: Oakland County: Alameda

State: CA Zip: 94612

Republic Services Approval #	Description of Waste	Volume/Weight	Expiration Date	Container Type
38251011244	Soil for disposal		12-31-2011	Tractor with Dump Trailer(s)
	RZ- _____ # _____	32.40 TON		

*Attach Additional Sheet if necessary

I hereby certify that the above-described materials are non-hazardous wastes as defined by 40 CFR 261 or any applicable state law. Further, that the above named materials are properly classified, described, packaged, marked and labeled, and are in proper condition for transportation according to the applicable regulations of the Department of Transportation.

Susan Crowley
Generator/Authorized Agent Name

Susan Crowley
Signature

Date Shipped

TRANSPORTER INFORMATION

Transporter Name: Las Vegas Paving

DOT # 191949

Address: 4420 S. Decatur

Truck Number: 07

Las Vegas, NV 89103

Phone Number: (702) 353-4355

I certify no hazardous waste or other regulated substance was knowingly introduced to the waste while in my custody. The waste transported in this vehicle is the waste identified above, to the best of my knowledge.

Ward R. Be...
Name of Authorized Agent

Jay Mason
Signature

10-7-10
Date Delivered

DISPOSAL SITE INFORMATION

Site Name: Apex Regional Landfill

Phone No. (702) 599-5920

Address: 13550 U.S. Hwy 93 Las Vegas, NV

I hereby acknowledge receipt of the above described materials

Name (Print or Type)

Signature

Date Received

81 Environmental Tech
13550 N Highway 93
Las Vegas, NV 89165

Ticket Type: INBOUND INVOICE

Ticket Number: 2038
Date: 10/08/2010
Time In: 12:01 am
Time Out: 12:31 am

Customer: 001011 - NGE, LLC c/o Northgate Environ Mgmt

Vehicle/Container: 81496P
Contract: Northgate Env. On Site Soils 3825 11
Comment: 3825 10 11244

Gross Weight: 116,500 LB Manual In
Tare Weight: 50,660 LB Manual Out
Net Weight: 65840 LB
Net Tons: 32.92

BOL: 12125

Origin	Yards	Material	Billing	Quantity
Not Applicable	0.00 YD	SW CONTAMINATED SOIL	32.92	TN

Driver: _____

Weighmaster: _____

SMITHJ

Indemnification. Customer agrees, by signature above, to indemnify, hold harmless, and defend Republic Services, Inc., its subsidiaries, affiliates, employees, officers and directors from and against any and all liabilities, claims, penalties, forfeitures, suits and the costs and expenses incident thereto, including costs of defense, settlement, and reasonable attorney's fees, which may be incurred, as a result of death or injuries to any person, or damage to any property, contamination of or adverse effects on the environment, caused in whole or in part by the Customer, its employees, or subcontractors in disposing waste at this Facility. In the event Customer delivers Unacceptable Waste (as determined by Republic) Customer agrees to assume all expenses and obligations with the removal and/or resolution of any effects caused by the delivery of such Unacceptable Waste.

Indemnización. Cliente acuerda indemnizar, mantener inmune, y defender Republic Services, Inc., sus subsidiarios, compañías, divisiones, empleados, oficiales y directores contra de cualquiera y de todas responsabilidades, demandas, penas, pérdidas, juicios, pleitos y los costos incidente además, incluyendo costos de defensa, de acuerdo judicial, y de honorarios razonables del abogado, que pueden ser incurridos en, o como resultado de, la muerte o herida personal a cualquier persona, o daños a cualquier característica, propiedad, contaminación de la tierra o efectos ilícitos en esta Facilidad, causado entero o en parte por el cliente, sus empleados, o sus subcontratistas en botar basura en esta Facilidad. En el caso que el Cliente entrega, bota, basura (según lo determinado por Republic) en este Establecimiento basura inaceptable en los reglamentos de este Establecimiento, el Cliente se compromete asumir todos los costos y obligaciones con el retiro y/o la resolución de cualquier dano(s) causado por la entrega de tal basura inaceptable.



NON-HAZARDOUS WASTE MANIFEST

MANIFEST # 12125

GENERATOR INFORMATION

Generator Name: Tronox LLC

Address: P.O. Box 55

City: Henderson County: Clark

State: NV Zip: 89009

Site Location (if different): 560 W. Lake Mead

Henderson, NV 89015 (702) 592-7727

CUSTOMER/BILLING INFORMATION

Billing Name: NGE LLC c/o Northgate Environment Management

Address: 300 Frank Ogawa Plaza, Ste 510

City: Oakland County: Alameda

State: CA Zip: 94612

Republic Services Approval #	Description of Waste	Volume/Weight	Expiration Date	Container Type
38251011244	Soil for disposal		12-31-2011	Tractor with Dump Trailer(s)
	RZ- #	22.52 TON		

*Attach Additional Sheet if necessary

I hereby certify that the above-described materials are non-hazardous wastes as defined by 40 CFR 261 or any applicable state law. Further, that the above named materials are properly classified, described, packaged, marked and labeled, and are in proper condition for transportation according to the applicable regulations of the Department of Transportation.

Susan Crowley (Signature) Generator/Authorized Agent Name Date Shipped

TRANSPORTER INFORMATION

Transporter Name: Las Vegas Paving

DOT # 191949

Address: 4420 S. Decatur

Truck Number: 145

Las Vegas, NV 89103

Phone Number: (702) 353-4355

I certify no hazardous waste or other regulated substance was knowingly introduced to the waste while in my custody. The waste transported in this vehicle is the waste identified above, to the best of my knowledge.

Harry W. Birt (Signature) Name of Authorized Agent Date Delivered 10-8-10

DISPOSAL SITE INFORMATION

Site Name: Apex Regional Landfill

Phone No. (702) 599-5920

Address: 13550 U.S. Hwy 93 Las Vegas, NV

I hereby acknowledge receipt of the above described materials

Eric Smith (Signature) Name (Print or Type) Date Received 10-7-10

81 Environmental Tech
13550 N Highway 93
Las Vegas, NV 89165

Ticket Type: INBOUND INVOICE

Ticket Number: 2039
Date: 10/08/2010
Time In: 12:07 am
Time Out: 12:32 am

Customer: 001011 - NGE, LLC c/o Northgate Environ Mgmt

Vehicle/Container: 34330A
Contract: Northgate Env. On Site Soils 3825 11
Comment: 3825 10 11244

Gross Weight: 112,280 LB Manual In
Tare Weight: 53,020 LB Manual Out
Net Weight: 59,260 LB
Net Tons: 29.63

BOL: 12127

Origin	Yards	Material	Billing	Quantity
Not Applicable	0.00 YD	SW CONTAMINATED SOIL	29.63	TN

Driver:

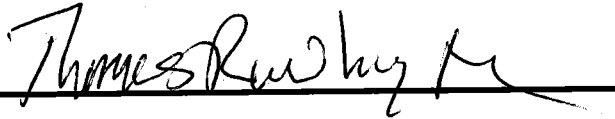

Weighmaster:

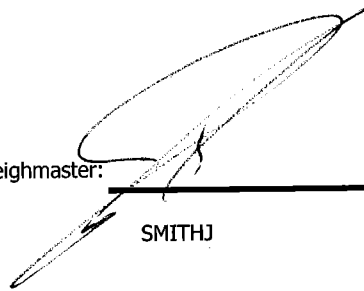

SMITHJ

Indemnification. Customer agrees, by signature above, to indemnify, hold harmless, and defend Republic Services, Inc., its subsidiaries, affiliates, employees, officers and directors from and against any and all liabilities, claims, penalties, forfeitures, suits and the costs and expenses incident thereto, including costs of defense, settlement, and reasonable attorney's fees, which may be incurred, as a result of death or injuries to any person, or damage to any property, contamination of or adverse effects on the environment, caused in whole or in part by the Customer, its employees, or subcontractors in disposing waste at this Facility. In the event Customer delivers Unacceptable Waste (as determined by Republic) Customer agrees to assume all expenses and obligations with the removal and/or resolution of any effects caused by the delivery of such Unacceptable Waste.

Indemnización. Cliente acuerda indemnizar, mantener inmune, y defender Republic Services, Inc., sus subsidiarios, compañías, divisiones, empleados, oficiales y directores contra de cualquiera y de todas responsabilidades, demandas, penas, pérdidas, juicios, pleitos y los costos incidente además, incluyendo costos de defensa, de acuerdo judicial, y de honorarios razonables del abogado, que pueden ser incurridos en, o como resultado de, la muerte o herida personal a cualquier persona, o daños a cualquier característica, propiedad, contaminación de la tierra o efectos ilícitos en esta Facilidad, causado entero o en parte por el cliente, sus empleados, o sus subcontratistas en botar basura en esta Facilidad. En el caso que el Cliente entrega, bota, basura (según lo determinado por Republic) en este Establecimiento basura inaceptable en los reglamentos de este Establecimiento, el Cliente se compromete asumir todos los costos y obligaciones con el retiro y/o la resolución de cualquier dano(s) causado por la entrega de tal basura inaceptable.



NON-HAZARDOUS WASTE MANIFEST

MANIFEST # 12127

GENERATOR INFORMATION

Generator Name: Tronox LLCAddress: P.O. Box 55City: Henderson County: ClarkState: NV Zip: 89009Site Location (if different): 560 W. Lake MeadHenderson, NV 89015 (702) 592-7727

CUSTOMER/BILLING INFORMATION

Billing Name: NGE LLC c/o Northgate Environment ManagementAddress: 300 Frank Ogawa Plaza, Ste 510City: Oakland County: AlamedaState: CA Zip: 94612

Republic Services Approval #	Description of Waste	Volume/Weight	Expiration Date	Container Type
38251011244	Soil for disposal		12-31-2011	Tractor with Dump Trailer(s)
	RZ- _____ # _____	<i>25.63 TON</i>		

*Attach Additional Sheet if necessary

I hereby certify that the above-described materials are non-hazardous wastes as defined by 40 CFR 261 or any applicable state law. Further, that the above named materials are properly classified, described, packaged, marked and labeled, and are in proper condition for transportation according to the applicable regulations of the Department of Transportation.

Susan Crowley
 Generator/Authorized Agent Name

Susan Crowley
 Signature

Date Shipped

TRANSPORTER INFORMATION

Transporter Name: Las Vegas PavingDOT # 191949Address: 4420 S. DecaturTruck Number: 981Las Vegas, NV 89103Phone Number: (702) 353-4355

I certify no hazardous waste or other regulated substance was knowingly introduced to the waste while in my custody. The waste transported in this vehicle is the waste identified above, to the best of my knowledge.

Thomas Powell
 Name of Authorized Agent

Signature

Date Delivered 10-7-10

DISPOSAL SITE INFORMATION

Site Name: Apex Regional LandfillPhone No. (702) 599-5920Address: 13550 U.S. Hwy 93 Las Vegas, NV

I hereby acknowledge receipt of the above described materials

Name (Print or Type)

Signature

Date Received 10-7-10

81 Environmental Tech
13550 N Highway 93
Las Vegas, NV 89165

Ticket Type: INBOUND INVOICE

Ticket Number: 2040
Date: 10/08/2010
Time In: 12:10 am
Time Out: 12:33 am

Customer: 001011 - NGE, LLC c/o Northgate Environ Mgmt

Vehicle/Container: 82418P
Contract: Northgate Env. On Site Soils 3825 11
Comment: 3825 10 11244

Gross Weight: 130,280 LB Manual In
Tare Weight: 60,140 LB Manual Out
Net Weight: 70140 LB
Net Tons: 35.07

BOL: 12129

Origin	Yards	Material	Billing	Quantity
Not Applicable	0.00 YD	SW CONTAMINATED SOIL	35.07	TN

Driver:

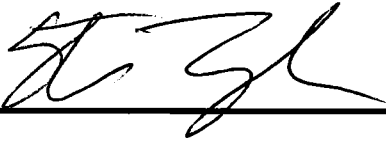

Weighmaster:

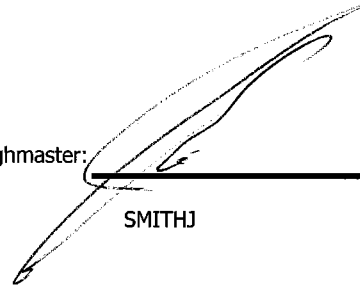

SMITHJ

Indemnification. Customer agrees, by signature above, to indemnify, hold harmless, and defend Republic Services, Inc., its subsidiaries, affiliates, employees, officers and directors from and against any and all liabilities, claims, penalties, forfeitures, suits and the costs and expenses incident thereto, including costs of defense, settlement, and reasonable attorney's fees, which may be incurred, as a result of death or injuries to any person, or damage to any property, contamination of or adverse effects on the environment, caused in whole or in part by the Customer, its employees, or subcontractors in disposing waste at this Facility. In the event Customer delivers Unacceptable Waste (as determined by Republic) Customer agrees to assume all expenses and obligations with the removal and/or resolution of any effects caused by the delivery of such Unacceptable Waste.

Indemnización. Cliente acuerda indemnizar, mantener inmune, y defender Republic Services, Inc., sus subsidiarios, compañías, divisiones, empleados, oficiales y directores contra de cualquiera y de todas responsabilidades, demandas, penas, pérdidas, juicios, pleitos y los costos incidente además, incluyendo costos de defensa, de acuerdo judicial, y de honorarios razonables del abogado, que pueden ser incurridos en, o como resultado de, la muerte o herida personal a cualquier persona, o daños a cualquier característica, propiedad, contaminación de la tierra o efectos ilícitos en esta Facilidad, causado entero o en parte por el cliente, sus empleados, o sus subcontratistas en botar basura en esta Facilidad. En el caso que el Cliente entrega, bota, basura (según lo determinado por Republic) en este Establecimiento basura inaceptable en los reglamentos de este Establecimiento, el Cliente se compromete asumir todos los costos y obligaciones con el retiro y/o la resolución de cualquier dano(s) causado por la entrega de tal basura inaceptable.



NON-HAZARDOUS WASTE MANIFEST

MANIFEST # 12129

GENERATOR INFORMATION

Generator Name: Tronox LLC

Address: P.O. Box 55

City: Henderson County: Clark

State: NV Zip: 89009

Site Location (if different): 560 W. Lake Mead

Henderson, NV 89015 (702) 592-7727

CUSTOMER/BILLING INFORMATION

Billing Name: NGE LLC c/o Northgate Environment Management

Address: 300 Frank Ogawa Plaza, Ste 510

City: Oakland County: Alameda

State: CA Zip: 94612

Table with 5 columns: Republic Services Approval #, Description of Waste, Volume/Weight, Expiration Date, Container Type. Row 1: 38251011244, Soil for disposal, 35.07 Tons, 12-31-2011, Tractor with Dump Trailer(s).

*Attach Additional Sheet if necessary

I hereby certify that the above-described materials are non-hazardous wastes as defined by 40 CFR 261 or any applicable state law. Further, that the above named materials are properly classified, described, packaged, marked and labeled, and are in proper condition for transportation according to the applicable regulations of the Department of Transportation.

Susan Crowley (Signature) Generator/Authorized Agent Name Signature Date Shipped

TRANSPORTER INFORMATION

Transporter Name: Las Vegas Paving

DOT # 191949

Address: 4420 S. Decatur

Truck Number: 220

Las Vegas, NV 89103

Phone Number: (702) 353-4355

I certify no hazardous waste or other regulated substance was knowingly introduced to the waste while in my custody. The waste transported in this vehicle is the waste identified above, to the best of my knowledge.

STEVE TAYLOR (Signature) Name of Authorized Agent Signature Date Delivered 10-7-10

DISPOSAL SITE INFORMATION

Site Name: Apex Regional Landfill

Phone No. (702) 599-5920

Address: 13550 U.S. Hwy 93 Las Vegas, NV

I hereby acknowledge receipt of the above described materials

Name (Print or Type) Signature Date Received

81 Environmental Tech
13550 N Highway 93
Las Vegas, NV 89165

Ticket Type: INBOUND INVOICE

Ticket Number: 2041
Date: 10/08/2010
Time In: 12:11 am
Time Out: 12:38 am

Customer: 001011 - NGE, LLC c/o Northgate Environ Mgmt

Vehicle/Container: 81460P
Contract: Northgate Env. On Site Soils 3825 11
Comment: 3825 10 11244

Gross Weight: 122,820 LB Manual In
Tare Weight: 56,360 LB Manual Out
Net Weight: 66460 LB
Net Tons: 33.23

BOL: 12128

Origin	Yards	Material	Billing	Quantity
Not Applicable	0.00 YD	SW CONTAMINATED SOIL	33.23	TN

Driver:



Weighmaster:

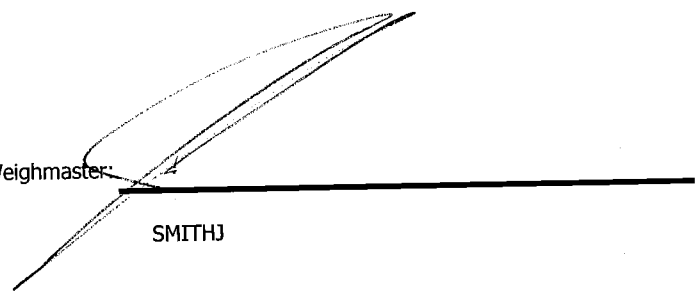

SMITHJ

Indemnification. Customer agrees, by signature above, to indemnify, hold harmless, and defend Republic Services, Inc., its subsidiaries, affiliates, employees, officers and directors from and against any and all liabilities, claims, penalties, forfeitures, suits and the costs and expenses incident thereto, including costs of defense, settlement, and reasonable attorney's fees, which may be incurred, as a result of death or injuries to any person, or damage to any property, contamination of or adverse effects on the environment, caused in whole or in part by the Customer, its employees, or subcontractors in disposing waste at this Facility. In the event Customer delivers Unacceptable Waste (as determined by Republic) Customer agrees to assume all expenses and obligations with the removal and/or resolution of any effects caused by the delivery of such Unacceptable Waste.

Indemnización. Cliente acuerda indemnizar, mantener inmune, y defender Republic Services, Inc., sus subsidiarios, compañías, divisiones, empleados, oficiales y directores contra de cualquiera y de todas responsabilidades, demandas, penas, pérdidas, juicios, pleitos y los costos incidente además, incluyendo costos de defensa, de acuerdo judicial, y de honorarios razonables del abogado, que pueden ser incurridos en, o como resultado de, la muerte o herida personal a cualquier persona, o daños a cualquier característica, propiedad, contaminación de la tierra o efectos ilícitos en esta Facilidad, causado entero o en parte por el cliente, sus empleados, o sus subcontratistas en botar basura en esta Facilidad. En el caso que el Cliente entrega, bota, basura (según lo determinado por Republic) en este Establecimiento basura inaceptable en los reglamentos de este Establecimiento, el Cliente se compromete asumir todos los costos y obligaciones con el retiro y/o la resolución de cualquier dano(s) causado por la entrega de tal basura inaceptable.



NON-HAZARDOUS WASTE MANIFEST

MANIFEST # 12128

GENERATOR INFORMATION

Generator Name: Tronox LLCAddress: P.O. Box 55City: Henderson County: ClarkState: NV Zip: 89009Site Location (if different): 560 W. Lake Mead
Henderson, NV 89015 (702) 592-7727

CUSTOMER/BILLING INFORMATION

Billing Name: NGE LLC c/o Northgate Environment ManagementAddress: 300 Frank Ogawa Plaza, Ste 510City: Oakland County: AlamedaState: CA Zip: 94612

Republic Services Approval #	Description of Waste	Volume/Weight	Expiration Date	Container Type
38251011244	Soil for disposal		12-31-2011	Tractor with Dump Trailer(s)
	RZ- _____ # _____	33-13 70		

*Attach Additional Sheet if necessary

I hereby certify that the above-described materials are non-hazardous wastes as defined by 40 CFR 261 or any applicable state law. Further, that the above named materials are properly classified, described, packaged, marked and labeled, and are in proper condition for transportation according to the applicable regulations of the Department of Transportation.

Susan Crowley
 Generator/Authorized Agent Name _____ Signature [Signature] Date Shipped _____

TRANSPORTER INFORMATION

Transporter Name: Las Vegas PavingDOT # 191949Address: 4420 S. DecaturTruck Number: 27Las Vegas, NV 89103Phone Number: (702) 353-4355

I certify no hazardous waste or other regulated substance was knowingly introduced to the waste while in my custody. The waste transported in this vehicle is the waste identified above, to the best of my knowledge.

Daniel Cardenas
 Name of Authorized Agent _____ Signature [Signature] Date Delivered 10-7-2010

DISPOSAL SITE INFORMATION

Site Name: Apex Regional LandfillPhone No. (702) 599-5920Address: 13550 U.S. Hwy 93 Las Vegas, NV

I hereby acknowledge receipt of the above described materials

[Signature]
 Name (Print or Type) _____ Signature _____ Date Received 10-7-10

81 Environmental Tech
13550 N Highway 93
Las Vegas, NV 89165

Ticket Type: INBOUND INVOICE

Ticket Number: 2042
Date: 10/08/2010
Time In: 12:16 am
Time Out: 12:40 am

Customer: 001011 - NGE, LLC c/o Northgate Environ Mgmt

Vehicle/Container: 86053P
Contract: Northgate Env. On Site Soils 3825 11
Comment: 3825 10 11244

Gross Weight: 121,780 LB Manual In
Tare Weight: 55,560 LB Manual Out
Net Weight: 66220 LB
Net Tons: 33.11

BOL: 12130

Origin	Yards	Material	Billing	Quantity
Not Applicable	0.00 YD	SW CONTAMINATED SOIL	33.11	TN

Driver: _____



Weighmaster: _____

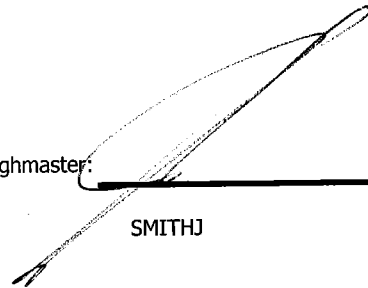

SMITHJ

Indemnification. Customer agrees, by signature above, to indemnify, hold harmless, and defend Republic Services, Inc., its subsidiaries, affiliates, employees, officers and directors from and against any and all liabilities, claims, penalties, forfeitures, suits and the costs and expenses incident thereto, including costs of defense, settlement, and reasonable attorney's fees, which may be incurred, as a result of death or injuries to any person, or damage to any property, contamination of or adverse effects on the environment, caused in whole or in part by the Customer, its employees, or subcontractors in disposing waste at this Facility. In the event Customer delivers Unacceptable Waste (as determined by Republic) Customer agrees to assume all expenses and obligations with the removal and/or resolution of any effects caused by the delivery of such Unacceptable Waste.

Indemnización. Cliente acuerda indemnizar, mantener inmune, y defender Republic Services, Inc., sus subsidiarios, compañías, divisiones, empleados, oficiales y directores contra de cualquiera y de todas responsabilidades, demandas, penas, pérdidas, juicios, pleitos y los costos incidente además, incluyendo costos de defensa, de acuerdo judicial, y de honorarios razonables del abogado, que pueden ser incurridos en, o como resultado de, la muerte o herida personal a cualquier persona, o daños a cualquier característica, propiedad, contaminación de la tierra o efectos ilícitos en esta Facilidad, causado entero o en parte por el cliente, sus empleados, o sus subcontratistas en botar basura en esta Facilidad. En el caso que el Cliente entrega, bota, basura (según lo determinado por Republic) en este Establecimiento basura inaceptable en los reglamentos de este Establecimiento, el Cliente se compromete asumir todos los costos y obligaciones con el retiro y/o la resolución de cualquier dano(s) causado por la entrega de tal basura inaceptable.



NON-HAZARDOUS WASTE MANIFEST

MANIFEST # 12130

GENERATOR INFORMATION

Generator Name: Tronox LLC

Address: P.O. Box 55

City: Henderson County: Clark

State: NV Zip: 89009

Site Location (if different): 560 W. Lake Mead

Henderson, NV 89015 (702) 592-7727

CUSTOMER/BILLING INFORMATION

Billing Name: NGE LLC c/o Northgate Environment Management

Address: 300 Frank Ogawa Plaza, Ste 510

City: Oakland County: Alameda

State: CA Zip: 94612

Republic Services Approval #	Description of Waste	Volume/Weight	Expiration Date	Container Type
38251011244	Soil for disposal		12-31-2011	Tractor with Dump Trailer(s)
	RZ- #	33 11 70		

*Attach Additional Sheet if necessary

I hereby certify that the above-described materials are non-hazardous wastes as defined by 40 CFR 261 or any applicable state law. Further, that the above named materials are properly classified, described, packaged, marked and labeled, and are in proper condition for transportation according to the applicable regulations of the Department of Transportation.

Susan Crowley

Susan Crowley

Generator/Authorized Agent Name

Signature

Date Shipped

TRANSPORTER INFORMATION

Transporter Name: Las Vegas Paving

DOT # 191949

Address: 4420 S. Decatur

Truck Number: 2601

Las Vegas, NV 89103

Phone Number: (702) 353-4355

I certify no hazardous waste or other regulated substance was knowingly introduced to the waste while in my custody. The waste transported in this vehicle is the waste identified above, to the best of my knowledge.

Patricia Jones

Patricia Jones

7 OCT 10

Name of Authorized Agent

Signature

Date Delivered

DISPOSAL SITE INFORMATION

Site Name: Apex Regional Landfill

Phone No. (702) 599-5920

Address: 13550 U.S. Hwy 93 Las Vegas, NV

I hereby acknowledge receipt of the above described materials

Isaac Smith

Isaac Smith

10-7-10

Name (Print or Type)

Signature

Date Received

81 Environmental Tech
13550 N Highway 93
Las Vegas, NV 89165

Ticket Type: INBOUND INVOICE

Ticket Number: 2043
Date: 10/08/2010
Time In: 12:20 am
Time Out: 12:42 am

Customer: 001011 - NGE, LLC c/o Northgate Environ Mgmt

Vehicle/Container: 76810P
Contract: Northgate Env. On Site Soils 3825 11
Comment: 3825 10 11244

Gross Weight: 121,980 LB Manual In
Tare Weight: 54,820 LB Manual Out
Net Weight: 67160 LB
Net Tons: 33.58

BOL: 12131

Origin	Yards	Material	Billing Quantity
Not Applicable	0.00 YD	SW CONTAMINATED SOIL	33.58 TN

Driver: _____

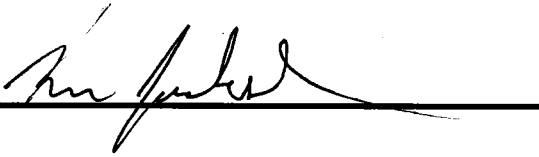

Weighmaster: _____

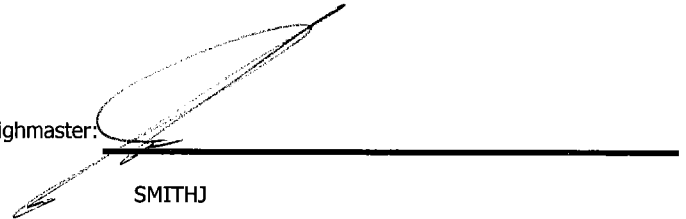

SMITHJ

Indemnification. Customer agrees, by signature above, to indemnify, hold harmless, and defend Republic Services, Inc., its subsidiaries, affiliates, employees, officers and directors from and against any and all liabilities, claims, penalties, forfeitures, suits and the costs and expenses incident thereto, including costs of defense, settlement, and reasonable attorney's fees, which may be incurred, as a result of death or injuries to any person, or damage to any property, contamination of or adverse effects on the environment, caused in whole or in part by the Customer, its employees, or subcontractors in disposing waste at this Facility. In the event Customer delivers Unacceptable Waste (as determined by Republic) Customer agrees to assume all expenses and obligations with the removal and/or resolution of any effects caused by the delivery of such Unacceptable Waste.

Indemnización. Cliente acuerda indemnizar, mantener inmune, y defender Republic Services, Inc., sus subsidiarios, compañías, divisiones, empleados, oficiales y directores contra de cualquiera y de todas responsabilidades, demandas, penas, pérdidas, juicios, pleitos y los costos incidente además, incluyendo costos de defensa, de acuerdo judicial, y de honorarios razonables del abogado, que pueden ser incurridos en, o como resultado de, la muerte o herida personal a cualquier persona, o daños a cualquier característica, propiedad, contaminación de la tierra o efectos ilícitos en esta Facilidad, causado entero o en parte por el cliente, sus empleados, o sus subcontratistas en botar basura en esta Facilidad. En el caso que el Cliente entrega, bota, basura (según lo determinado por Republic) en este Establecimiento basura inaceptable en los reglamentos de este Establecimiento, el Cliente se compromete asumir todos los costos y obligaciones con el retiro y/o la resolución de cualquier dano(s) causado por la entrega de tal basura inaceptable.



NON-HAZARDOUS WASTE MANIFEST

MANIFEST # 12131

GENERATOR INFORMATION

Generator Name: Tronox LLC

Address: P.O. Box 55

City: Henderson County: Clark

State: NV Zip: 89009

Site Location (if different): 560 W. Lake Mead

Henderson, NV 89015 (702) 592-7727

CUSTOMER/BILLING INFORMATION

Billing Name: NGE LLC c/o Northgate Environment Management

Address: 300 Frank Ogawa Plaza, Ste 510

City: Oakland County: Alameda

State: CA Zip: 94612

Republic Services Approval #	Description of Waste	Volume/Weight	Expiration Date	Container Type
38251011244	Soil for disposal		12-31-2011	Tractor with Dump Trailer(s)
	RZ- #	33.89 TON		

*Attach Additional Sheet if necessary

I hereby certify that the above-described materials are non-hazardous wastes as defined by 40 CFR 261 or any applicable state law. Further, that the above named materials are properly classified, described, packaged, marked and labeled, and are in proper condition for transportation according to the applicable regulations of the Department of Transportation.

Susan Crowley
Generator/Authorized Agent Name
Signature
Date Shipped

TRANSPORTER INFORMATION

Transporter Name: Las Vegas Paving

DOT # 191949

Address: 4420 S. Decatur

Truck Number: 241

Las Vegas, NV 89103

Phone Number: (702) 353-4355

I certify no hazardous waste or other regulated substance was knowingly introduced to the waste while in my custody. The waste transported in this vehicle is the waste identified above, to the best of my knowledge.

Name of Authorized Agent
Signature
Date Delivered

DISPOSAL SITE INFORMATION

Site Name: Apex Regional Landfill

Phone No. (702) 599-5920

Address: 13550 U.S. Hwy 93 Las Vegas, NV

I hereby acknowledge receipt of the above described materials

Name (Print or Type)
Signature
Date Received

81 Environmental Tech
13550 N Highway 93
Las Vegas, NV 89165

Ticket Type: INBOUND INVOICE

Ticket Number: 2044
Date: 10/08/2010
Time In: 12:24 am
Time Out: 12:43 am

Customer: 001011 - NGE, LLC c/o Northgate Environ Mgmt

Vehicle/Container: 81494P
Contract: Northgate Env. On Site Soils 3825 11
Comment: 3825 10 11244

Gross Weight: 112,920 LB Manual In
Tare Weight: 51,200 LB Manual Out
Net Weight: 61,720 LB
Net Tons: 30.86

BOL: 12132

Origin	Yards	Material	Billing	Quantity
Not Applicable	0.00 YD	SW CONTAMINATED SOIL	30.86	TN

Driver: _____

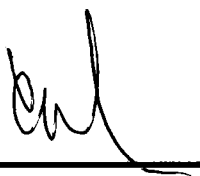

Weighmaster: _____

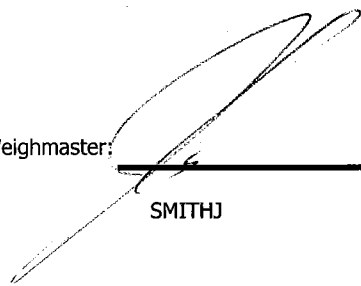

SMITHJ

Indemnification. Customer agrees, by signature above, to indemnify, hold harmless, and defend Republic Services, Inc., its subsidiaries, affiliates, employees, officers and directors from and against any and all liabilities, claims, penalties, forfeitures, suits and the costs and expenses incident thereto, including costs of defense, settlement, and reasonable attorney's fees, which may be incurred, as a result of death or injuries to any person, or damage to any property, contamination of or adverse effects on the environment, caused in whole or in part by the Customer, its employees, or subcontractors in disposing waste at this Facility. In the event Customer delivers Unacceptable Waste (as determined by Republic) Customer agrees to assume all expenses and obligations with the removal and/or resolution of any effects caused by the delivery of such Unacceptable Waste.

Indemnización. Cliente acuerda indemnizar, mantener inmune, y defender Republic Services, Inc., sus subsidiarios, compañías, divisiones, empleados, oficiales y directores contra de cualquiera y de todas responsabilidades, demandas, penas, pérdidas, juicios, pleitos y los costos incidente además, incluyendo costos de defensa, de acuerdo judicial, y de honorarios razonables del abogado, que pueden ser incurridos en, o como resultado de, la muerte o herida personal a cualquier persona, o daños a cualquier característica, propiedad, contaminación de la tierra o efectos ilícitos en esta Facilidad, causado entero o en parte por el cliente, sus empleados, o sus subcontratistas en botar basura en esta Facilidad. En el caso que el Cliente entrega, bota, basura (según lo determinado por Republic) en este Establecimiento basura inaceptable en los reglamentos de este Establecimiento, el Cliente se compromete asumir todos los costos y obligaciones con el retiro y/o la resolución de cualquier dano(s) causado por la entrega de tal basura inaceptable.



NON-HAZARDOUS WASTE MANIFEST

MANIFEST # 12132

GENERATOR INFORMATION

Generator Name: Tronox LLC

Address: P.O. Box 55

City: Henderson County: Clark

State: NV Zip: 89009

Site Location (if different): 560 W. Lake Mead

Henderson, NV 89015 (702) 592-7727

CUSTOMER/BILLING INFORMATION

Billing Name: NGE LLC c/o Northgate Environment Management

Address: 300 Frank Ogawa Plaza, Ste 510

City: Oakland County: Alameda

State: CA Zip: 94612

Republic Services Approval #	Description of Waste	Volume/Weight	Expiration Date	Container Type
38251011244	Soil for disposal		12-31-2011	Tractor with Dump Trailer(s)
	RZ- #	30.8 TA		

*Attach Additional Sheet if necessary

I hereby certify that the above-described materials are non-hazardous wastes as defined by 40 CFR 261 or any applicable state law. Further, that the above named materials are properly classified, described, packaged, marked and labeled, and are in proper condition for transportation according to the applicable regulations of the Department of Transportation.

Susan Crowley
Generator/Authorized Agent Name
Signature
Date Shipped

TRANSPORTER INFORMATION

Transporter Name: Las Vegas Paving

DOT # 191949

Address: 4420 S. Decatur

Truck Number: 127

Las Vegas, NV 89103

Phone Number: (702) 353-4355

I certify no hazardous waste or other regulated substance was knowingly introduced to the waste while in my custody. The waste transported in this vehicle is the waste identified above, to the best of my knowledge.

Calvin Paguyo
Name of Authorized Agent
Signature
Date Delivered 10-07-10

DISPOSAL SITE INFORMATION

Site Name: Apex Regional Landfill

Phone No. (702) 599-5920

Address: 13550 U.S. Hwy 93 Las Vegas, NV

I hereby acknowledge receipt of the above described materials

Name (Print or Type) Signature Date Received 10-7-10

81 Environmental Tech
13550 N Highway 93
Las Vegas, NV 89165

Ticket Type: INBOUND INVOICE

Ticket Number: 2045
Date: 10/08/2010
Time In: 12:27 am
Time Out: 12:49 am

Customer: 001011 - NGE, LLC c/o Northgate Environ Mgmt

Vehicle/Container: 76811P
Contract: Northgate Env. On Site Soils 3825 11
Comment: 3825 10 11244

Gross Weight: 123,420 LB Manual In
Tare Weight: 53,200 LB Manual Out
Net Weight: 70220 LB
Net Tons: 35.11

BOL: 12133

Origin	Yards	Material	Billing	Quantity
Not Applicable	0.00 YD	SW CONTAMINATED SOIL	35.11	TN

Driver:



Weighmaster:

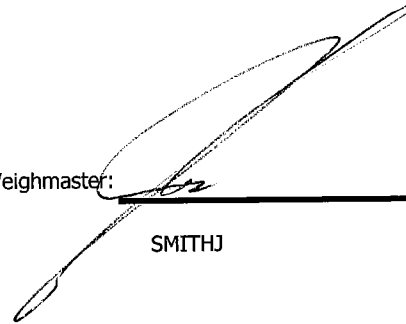

SMITHJ

Indemnification. Customer agrees, by signature above, to indemnify, hold harmless, and defend Republic Services, Inc., its subsidiaries, affiliates, employees, officers and directors from and against any and all liabilities, claims, penalties, forfeitures, suits and the costs and expenses incident thereto, including costs of defense, settlement, and reasonable attorney's fees, which may be incurred, as a result of death or injuries to any person, or damage to any property, contamination of or adverse effects on the environment, caused in whole or in part by the Customer, its employees, or subcontractors in disposing waste at this Facility. In the event Customer delivers Unacceptable Waste (as determined by Republic) Customer agrees to assume all expenses and obligations with the removal and/or resolution of any effects caused by the delivery of such Unacceptable Waste.

Indemnización. Cliente acuerda indemnizar, mantener inmune, y defender Republic Services, Inc., sus subsidiarios, compañías, divisiones, empleados, oficiales y directores contra de cualquiera y de todas responsabilidades, demandas, penas, pérdidas, juicios, pleitos y los costos incidente además, incluyendo costos de defensa, de acuerdo judicial, y de honorarios razonables del abogado, que pueden ser incurridos en, o como resultado de, la muerte o herida personal a cualquier persona, o daños a cualquier característica, propiedad, contaminación de la tierra o efectos ilícitos en esta Facilidad, causado entero o en parte por el cliente, sus empleados, o sus subcontratistas en botar basura en esta Facilidad. En el caso que el Cliente entrega, bota, basura (según lo determinado por Republic) en este Establecimiento basura inaceptable en los reglamentos de este Establecimiento, el Cliente se compromete asumir todos los costos y obligaciones con el retiro y/o la resolución de cualquier dano(s) causado por la entrega de tal basura inaceptable.



NON-HAZARDOUS WASTE MANIFEST

MANIFEST # 12133

GENERATOR INFORMATION

Generator Name: Tronox LLC

Address: P.O. Box 55

City: Henderson County: Clark

State: NV Zip: 89009

Site Location (if different): 560 W. Lake Mead

Henderson, NV 89015 (702) 592-7727

CUSTOMER/BILLING INFORMATION

Billing Name: NGE LLC c/o Northgate Environment Management

Address: 300 Frank Ogawa Plaza, Ste 510

City: Oakland County: Alameda

State: CA Zip: 94612

Republic Services Approval #	Description of Waste	Volume/Weight	Expiration Date	Container Type
38251011244	Soil for disposal		12-31-2011	Tractor with Dump Trailer(s)
	RZ- #	35.1170		

*Attach Additional Sheet if necessary

I hereby certify that the above-described materials are non-hazardous wastes as defined by 40 CFR 261 or any applicable state law. Further, that the above named materials are properly classified, described, packaged, marked and labeled, and are in proper condition for transportation according to the applicable regulations of the Department of Transportation.

Susan Crowley Generator/Authorized Agent Name Signature Date Shipped

TRANSPORTER INFORMATION

Transporter Name: Las Vegas Paving

DOT # 191949

Address: 4420 S. Decatur

Truck Number: 242

Las Vegas, NV 89103

Phone Number: (702) 353-4355

I certify no hazardous waste or other regulated substance was knowingly introduced to the waste while in my custody. The waste transported in this vehicle is the waste identified above, to the best of my knowledge.

Mike Hefferon Name of Authorized Agent Signature Date Delivered 10-7-10

DISPOSAL SITE INFORMATION

Site Name: Apex Regional Landfill

Phone No. (702) 599-5920

Address: 13550 U.S. Hwy 93 Las Vegas, NV

I hereby acknowledge receipt of the above described materials Name (Print or Type) Signature Date Received 10-7-10

81 Environmental Tech
13550 N Highway 93
Las Vegas, NV 89165

Ticket Type: INBOUND INVOICE

Ticket Number: 2046
Date: 10/08/2010
Time In: 12:38 am
Time Out: 1:03 am

Customer: 001011 - NGE, LLC c/o Northgate Environ Mgmt

Vehicle/Container: 68263P
Contract: Northgate Env. On Site Soils 3825 11
Comment: 3825 10 11244

Gross Weight: 126,380 LB Manual In
Tare Weight: 53,540 LB Manual Out
Net Weight: 72840 LB
Net Tons: 36.42

BOL: 12134

Origin	Yards	Material	Billing Quantity
Not Applicable	0.00 YD	SW CONTAMINATED SOIL	36.42 TN

Driver: 

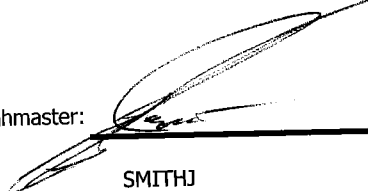
Weighmaster: 
SMITHJ

Indemnification. Customer agrees, by signature above, to indemnify, hold harmless, and defend Republic Services, Inc., its subsidiaries, affiliates, employees, officers and directors from and against any and all liabilities, claims, penalties, forfeitures, suits and the costs and expenses incident thereto, including costs of defense, settlement, and reasonable attorney's fees, which may be incurred, as a result of death or injuries to any person, or damage to any property, contamination of or adverse effects on the environment, caused in whole or in part by the Customer, its employees, or subcontractors in disposing waste at this Facility. In the event Customer delivers Unacceptable Waste (as determined by Republic) Customer agrees to assume all expenses and obligations with the removal and/or resolution of any effects caused by the delivery of such Unacceptable Waste.

Indemnización. Cliente acuerda indemnizar, mantener inmune, y defender Republic Services, Inc., sus subsidiarios, companias, divisiones, empleados, oficiales y directores contra de cualquiera y de todas responsabilidades, demandas, penas, pérdidas, juicios, pleitos y los costos incidente además, incluyendo costos de defensa, de acuerdo judicial, y de honorarios razonables del abogado, que pueden ser incurridos en, o como resultado de, la muerte o herida personal a cualquier persona, o daños a cualquier característica, propiedad, contaminación de la tierra o efectos ilicitos en esta Facilidat, causado entero o en parte por el cliente, sus empleados, o sus subcontratistas en botar basura en esta Facilidat. En el caso que el Cliente entrega, bota, basura (según lo determinado por Republic) en este Establecimiento basura inaceptable en los reglamentos de este Establecimiento, el Cliente se compromete asumir todos los costos y obligaciones con el retiro y/o la resolución de cualquier dano(s) causado por la entrega de tal basura inaceptable.



NON-HAZARDOUS WASTE MANIFEST

MANIFEST # 12134

GENERATOR INFORMATION

Generator Name: Tronox LLC

Address: P.O. Box 55

City: Henderson County: Clark

State: NV Zip: 89009

Site Location (if different): 560 W. Lake Mead

Henderson, NV 89015 (702) 592-7727

CUSTOMER/BILLING INFORMATION

Billing Name: NGE LLC c/o Northgate Environment Management

Address: 300 Frank Ogawa Plaza, Ste 510

City: Oakland County: Alameda

State: CA Zip: 94612

Republic Services Approval #	Description of Waste	Volume/Weight	Expiration Date	Container Type
38251011244	Soil for disposal		12-31-2011	Tractor with Dump Trailer(s)
	RZ- #	26.97 T		

*Attach Additional Sheet if necessary

I hereby certify that the above-described materials are non-hazardous wastes as defined by 40 CFR 261 or any applicable state law. Further, that the above named materials are properly classified, described, packaged, marked and labeled, and are in proper condition for transportation according to the applicable regulations of the Department of Transportation.

Susan Crowley Generator/Authorized Agent Name Signature Date Shipped

TRANSPORTER INFORMATION

Transporter Name: Las Vegas Paving

DOT # 191949

Address: 4420 S. Decatur

Truck Number: 2711

Las Vegas, NV 89103

Phone Number: (702) 353-4355

I certify no hazardous waste or other regulated substance was knowingly introduced to the waste while in my custody. The waste transported in this vehicle is the waste identified above, to the best of my knowledge.

STEVE HAYES Name of Authorized Agent Signature Date Delivered 10-7-10

DISPOSAL SITE INFORMATION

Site Name: Apex Regional Landfill

Phone No. (702) 599-5920

Address: 13550 U.S. Hwy 93 Las Vegas, NV

I hereby acknowledge receipt of the above described materials Name (Print or Type) Signature Date Received 10-7-10

81 Environmental Tech
13550 N Highway 93
Las Vegas, NV 89165

Ticket Type: INBOUND INVOICE

Ticket Number: 2047
Date: 10/08/2010
Time In: 12:40 am
Time Out: 1:05 am

Customer: 001011 - NGE, LLC c/o Northgate Environ Mgmt

Vehicle/Container: 35902A
Contract: Northgate Env. On Site Soils 3825 11
Comment: 3825 10 11244

Gross Weight: 129,520 LB Manual In
Tare Weight: 57,700 LB Manual Out
Net Weight: 71820 LB
Net Tons: 35.91

BOL: 12135

Origin	Yards	Material	Billing	Quantity
Not Applicable	0.00 YD	SW CONTAMINATED SOIL	35.91	TN

Driver: _____

Weighmaster: _____

SMITHJ

Indemnification. Customer agrees, by signature above, to indemnify, hold harmless, and defend Republic Services, Inc., its subsidiaries, affiliates, employees, officers and directors from and against any and all liabilities, claims, penalties, forfeitures, suits and the costs and expenses incident thereto, including costs of defense, settlement, and reasonable attorney's fees, which may be incurred, as a result of death or injuries to any person, or damage to any property, contamination of or adverse effects on the environment, caused in whole or in part by the Customer, its employees, or subcontractors in disposing waste at this Facility. In the event Customer delivers Unacceptable Waste (as determined by Republic) Customer agrees to assume all expenses and obligations with the removal and/or resolution of any effects caused by the delivery of such Unacceptable Waste.

Indemnización. Cliente acuerda indemnizar, mantener inmune, y defender Republic Services, Inc., sus subsidiarios, compañías, divisiones, empleados, oficiales y directores contra de cualquiera y de todas responsabilidades, demandas, penas, pérdidas, juicios, pleitos y los costos incidente además, incluyendo costos de defensa, de acuerdo judicial, y de honorarios razonables del abogado, que pueden ser incurridos en, o como resultado de, la muerte o herida personal a cualquier persona, o daños a cualquier característica, propiedad, contaminación de la tierra o efectos ilícitos en esta Facilidad, causado entero o en parte por el cliente, sus empleados, o sus subcontratistas en botar basura en esta Facilidad. En el caso que el Cliente entrega, bota, basura (según lo determinado por Republic) en este Establecimiento basura inaceptable en los reglamentos de este Establecimiento, el Cliente se compromete asumir todos los costos y obligaciones con el retiro y/o la resolución de cualquier dano(s) causado por la entrega de tal basura inaceptable.



NON-HAZARDOUS WASTE MANIFEST

MANIFEST # 12135

GENERATOR INFORMATION

Generator Name: Tronox LLC

Address: P.O. Box 55

City: Henderson County: Clark

State: NV Zip: 89009

Site Location (if different): 560 W. Lake Mead

Henderson, NV 89015 (702) 592-7727

CUSTOMER/BILLING INFORMATION

Billing Name: NGE LLC c/o Northgate Environment Management

Address: 300 Frank Ogawa Plaza, Ste 510

City: Oakland County: Alameda

State: CA Zip: 94612

Republic Services Approval #	Description of Waste	Volume/Weight	Expiration Date	Container Type
38251011244	Soil for disposal		12-31-2011	Tractor with Dump Trailer(s)
	RZ- _____ # _____	35.51 TL		

*Attach Additional Sheet if necessary

I hereby certify that the above-described materials are non-hazardous wastes as defined by 40 CFR 261 or any applicable state law. Further, that the above named materials are properly classified, described, packaged, marked and labeled, and are in proper condition for transportation according to the applicable regulations of the Department of Transportation.

Susan Crowley
Generator/Authorized Agent Name

Susan Crowley
Signature

Date Shipped

TRANSPORTER INFORMATION

Transporter Name: Las Vegas Paving

DOT # 191949

Address: 4420 S. Decatur

Truck Number: 071

Las Vegas, NV 89103

Phone Number: (702) 353-4355

I certify no hazardous waste or other regulated substance was knowingly introduced to the waste while in my custody. The waste transported in this vehicle is the waste identified above, to the best of my knowledge.

Ned M
Name of Authorized Agent

Ned M
Signature

10-7-10
Date Delivered

DISPOSAL SITE INFORMATION

Site Name: Apex Regional Landfill

Phone No. (702) 599-5920

Address: 13550 U.S. Hwy 93 Las Vegas, NV

I hereby acknowledge receipt of the above described materials

Jesse Smith
Name (Print or Type)

Jesse Smith
Signature

10-7-10
Date Received

81 Environmental Tech
13550 N Highway 93
Las Vegas, NV 89165

Ticket Type: INBOUND INVOICE

Ticket Number: 2048
Date: 10/08/2010
Time In: 1:01 am
Time Out: 1:23 am

Customer: 001011 - NGE, LLC c/o Northgate Environ Mgmt

Vehicle/Container: 44165A
Contract: Northgate Env. On Site Soils 3825 11
Comment: 3825 10 11244

Gross Weight: 127,340 LB Manual In
Tare Weight: 48,540 LB Manual Out
Net Weight: 78800 LB
Net Tons: 39.40

BOL: 12136

Origin	Yards	Material	Billing	Quantity
Not Applicable	0.00 YD	SW CONTAMINATED SOIL	39.40	TN

Driver:



Weighmaster:

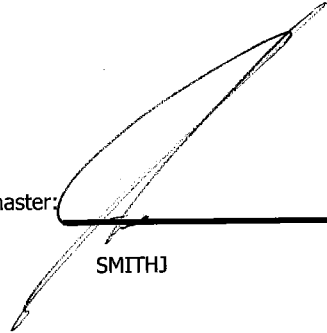

SMITHJ

Indemnification. Customer agrees, by signature above, to indemnify, hold harmless, and defend Republic Services, Inc., its subsidiaries, affiliates, employees, officers and directors from and against any and all liabilities, claims, penalties, forfeitures, suits and the costs and expenses incident thereto, including costs of defense, settlement, and reasonable attorney's fees, which may be incurred, as a result of death or injuries to any person, or damage to any property, contamination of or adverse effects on the environment, caused in whole or in part by the Customer, its employees, or subcontractors in disposing waste at this Facility. In the event Customer delivers Unacceptable Waste (as determined by Republic) Customer agrees to assume all expenses and obligations with the removal and/or resolution of any effects caused by the delivery of such Unacceptable Waste.

Indemnización. Cliente acuerda indemnizar, mantener inmune, y defender Republic Services, Inc., sus subsidiarios, compañías, divisiones, empleados, oficiales y directores contra de cualquiera y de todas responsabilidades, demandas, penas, pérdidas, juicios, pleitos y los costos incidente además, incluyendo costos de defensa, de acuerdo judicial, y de honorarios razonables del abogado, que pueden ser incurridos en, o como resultado de, la muerte o herida personal a cualquier persona, o daños a cualquier característica, propiedad, contaminación de la tierra o efectos ilícitos en esta Facilidad, causado entero o en parte por el cliente, sus empleados, o sus subcontratistas en botar basura en esta Facilidad. En el caso que el Cliente entrega, bota, basura (según lo determinado por Republic) en este Establecimiento basura inaceptable en los reglamentos de este Establecimiento, el Cliente se compromete asumir todos los costos y obligaciones con el retiro y/o la resolución de cualquier dano(s) causado por la entrega de tal basura inaceptable.



NON-HAZARDOUS WASTE MANIFEST

MANIFEST # 12136

GENERATOR INFORMATION

Generator Name: Tronox LLC

Address: P.O. Box 55

City: Henderson County: Clark

State: NV Zip: 89009

Site Location (if different): 560 W. Lake Mead

Henderson, NV 89015 (702) 592-7727

CUSTOMER/BILLING INFORMATION

Billing Name: NGE LLC c/o Northgate Environment Management

Address: 300 Frank Ogawa Plaza, Ste 510

City: Oakland County: Alameda

State: CA Zip: 94612

Republic Services Approval #	Description of Waste	Volume/Weight	Expiration Date	Container Type
38251011244	Soil for disposal		12-31-2011	Tractor with Dump Trailer(s)
	RZ- #	39.4070		

*Attach Additional Sheet if necessary

I hereby certify that the above-described materials are non-hazardous wastes as defined by 40 CFR 261 or any applicable state law. Further, that the above named materials are properly classified, described, packaged, marked and labeled, and are in proper condition for transportation according to the applicable regulations of the Department of Transportation.

Susan Crowley (Signature) Date Shipped

TRANSPORTER INFORMATION

Transporter Name: Las Vegas Paving

DOT # 191949

Address: 4420 S. Decatur

Truck Number: 15001

Las Vegas, NV 89103

Phone Number: (702) 353-4355

I certify no hazardous waste or other regulated substance was knowingly introduced to the waste while in my custody. The waste transported in this vehicle is the waste identified above, to the best of my knowledge.

RIANOL (Signature) Date Delivered: 10-7-10

DISPOSAL SITE INFORMATION

Site Name: Apex Regional Landfill

Phone No. (702) 599-5920

Address: 13550 U.S. Hwy 93 Las Vegas, NV

I hereby acknowledge receipt of the above described materials (Signature) Date Received: 10-7-10

81 Environmental Tech
13550 N Highway 93
Las Vegas, NV 89165

Ticket Type: INBOUND INVOICE

Ticket Number: 2049
Date: 10/08/2010
Time In: 1:18 am
Time Out: 1:45 am

Customer: 001011 - NGE, LLC c/o Northgate Environ Mgmt

Vehicle/Container: 44564A
Contract: Northgate Env. On Site Soils 3825 11
Comment: 3825 10 11244

Gross Weight: 133,220 LB Manual In
Tare Weight: 49,300 LB Manual Out
Net Weight: 83920 LB
Net Tons: 41.96

BOL: 12138

Origin	Yards	Material	Billing	Quantity
Not Applicable	0.00 YD	SW CONTAMINATED SOIL	41.96	TN

Driver: _____

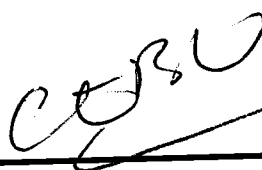

Weighmaster: _____

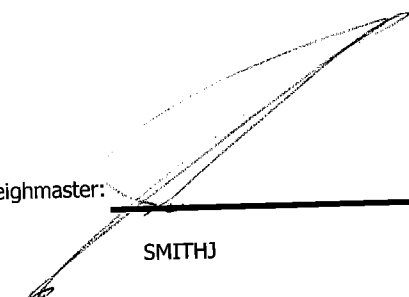

SMITHJ

Indemnification. Customer agrees, by signature above, to indemnify, hold harmless, and defend Republic Services, Inc., its subsidiaries, affiliates, employees, officers and directors from and against any and all liabilities, claims, penalties, forfeitures, suits and the costs and expenses incident thereto, including costs of defense, settlement, and reasonable attorney's fees, which may be incurred, as a result of death or injuries to any person, or damage to any property, contamination of or adverse effects on the environment, caused in whole or in part by the Customer, its employees, or subcontractors in disposing waste at this Facility. In the event Customer delivers Unacceptable Waste (as determined by Republic) Customer agrees to assume all expenses and obligations with the removal and/or resolution of any effects caused by the delivery of such Unacceptable Waste.

Indemnización. Cliente acuerda indemnizar, mantener inmune, y defender Republic Services, Inc., sus subsidiarios, compañías, divisiones, empleados, oficiales y directores contra de cualquiera y de todas responsabilidades, demandas, penas, pérdidas, juicios, pleitos y los costos incidente además, incluyendo costos de defensa, de acuerdo judicial, y de honorarios razonables del abogado, que pueden ser incurridos en, o como resultado de, la muerte o herida personal a cualquier persona, o daños a cualquier característica, propiedad, contaminación de la tierra o efectos ilícitos en esta Facilidad, causado entero o en parte por el cliente, sus empleados, o sus subcontratistas en botar basura en esta Facilidad. En el caso que el Cliente entrega, bota, basura (según lo determinado por Republic) en este Establecimiento basura inaceptable en los reglamentos de este Establecimiento, el Cliente se compromete asumir todos los costos y obligaciones con el retiro y/o la resolución de cualquier dano(s) causado por la entrega de tal basura inaceptable.



NON-HAZARDOUS WASTE MANIFEST

MANIFEST # 12136

GENERATOR INFORMATION

Generator Name: Tronox LLCAddress: P.O. Box 55City: Henderson County: ClarkState: NV Zip: 89009Site Location (if different): 560 W. Lake MeadHenderson, NV 89015 (702) 592-7727

CUSTOMER/BILLING INFORMATION

Billing Name: NGE LLC c/o Northgate Environment ManagementAddress: 300 Frank Ogawa Plaza, Ste 510City: Oakland County: AlamedaState: CA Zip: 94612

Republic Services Approval #	Description of Waste	Volume/Weight	Expiration Date	Container Type
38251011244	Soil for disposal		12-31-2011	Tractor with Dump Trailer(s)
	RZ- _____ # _____	41.96 TON		

*Attach Additional Sheet if necessary

I hereby certify that the above-described materials are non-hazardous wastes as defined by 40 CFR 261 or any applicable state law. Further, that the above named materials are properly classified, described, packaged, marked and labeled, and are in proper condition for transportation according to the applicable regulations of the Department of Transportation.

Susan Crowley
 Generator/Authorized Agent Name

Susan Crowley
 Signature

Date Shipped

TRANSPORTER INFORMATION

Transporter Name: Las Vegas PavingDOT # 191949Address: 4420 S. DecaturTruck Number: K003Las Vegas, NV 89103Phone Number: (702) 353-4355

I certify no hazardous waste or other regulated substance was knowingly introduced to the waste while in my custody. The waste transported in this vehicle is the waste identified above, to the best of my knowledge.

CEBU
 Name of Authorized Agent

CEBU
 Signature

10/07/10
 Date Delivered

DISPOSAL SITE INFORMATION

Site Name: Apex Regional LandfillPhone No. (702) 599-5920Address: 13550 U.S. Hwy 93 Las Vegas, NV

I hereby acknowledge receipt of the above described materials

Kevin Smith
 Name (Print or Type)

Signature

10-7-10
 Date Received

81 Environmental Tech
13550 N Highway 93
Las Vegas, NV 89165

Ticket Type: INBOUND INVOICE

Ticket Number: 2050
Date: 10/08/2010
Time In: 1:21 am
Time Out: 1:45 am

Customer: 001011 - NGE, LLC c/o Northgate Environ Mgmt

Vehicle/Container: 85887P
Contract: Northgate Env. On Site Soils 3825 11
Comment: 3825 10 11244

Gross Weight: 134,040 LB Manual In
Tare Weight: 51,680 LB Manual Out
Net Weight: 82360 LB
Net Tons: 41.18

BOL: 12139

Origin	Yards	Material	Billing	Quantity
Not Applicable	0.00 YD	SW CONTAMINATED SOIL	41.18	TN

Driver:

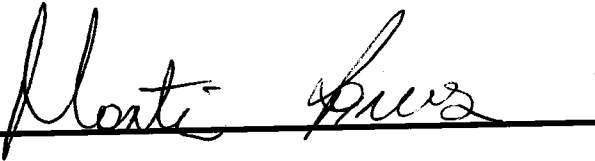

Weighmaster:

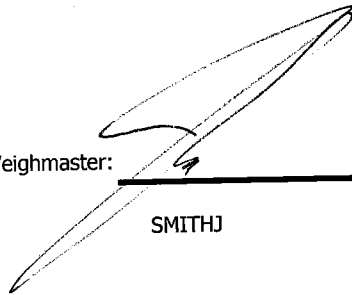

SMITHJ

Indemnification. Customer agrees, by signature above, to indemnify, hold harmless, and defend Republic Services, Inc., its subsidiaries, affiliates, employees, officers and directors from and against any and all liabilities, claims, penalties, forfeitures, suits and the costs and expenses incident thereto, including costs of defense, settlement, and reasonable attorney's fees, which may be incurred, as a result of death or injuries to any person, or damage to any property, contamination of or adverse effects on the environment, caused in whole or in part by the Customer, its employees, or subcontractors in disposing waste at this Facility. In the event Customer delivers Unacceptable Waste (as determined by Republic) Customer agrees to assume all expenses and obligations with the removal and/or resolution of any effects caused by the delivery of such Unacceptable Waste.

Indemnización. Cliente acuerda indemnizar, mantener inmune, y defender Republic Services, Inc., sus subsidiarios, compañías, divisiones, empleados, oficiales y directores contra de cualquiera y de todas responsabilidades, demandas, penas, pérdidas, juicios, pleitos y los costos incidente además, incluyendo costos de defensa, de acuerdo judicial, y de honorarios razonables del abogado, que pueden ser incurridos en, o como resultado de, la muerte o herida personal a cualquier persona, o daños a cualquier característica, propiedad, contaminación de la tierra o efectos ilícitos en esta Facilidad, causado entero o en parte por el cliente, sus empleados, o sus subcontratistas en botar basura en esta Facilidad. En el caso que el Cliente entrega, bota, basura (según lo determinado por Republic) en este Establecimiento basura inaceptable en los reglamentos de este Establecimiento, el Cliente se compromete asumir todos los costos y obligaciones con el retiro y/o la resolución de cualquier dano(s) causado por la entrega de tal basura inaceptable.



NON-HAZARDOUS WASTE MANIFEST

MANIFEST # 12139

GENERATOR INFORMATION

Generator Name: Tronox LLC
Address: P.O. Box 55
City: Henderson County: Clark
State: NV Zip: 89009
Site Location (if different): 560 W. Lake Mead
Henderson, NV 89015 (702) 592-7727

CUSTOMER/BILLING INFORMATION

Billing Name: NGE LLC c/o Northgate Environment Management
Address: 300 Frank Ogawa Plaza, Ste 510
City: Oakland County: Alameda
State: CA Zip: 94612

Table with 5 columns: Republic Services Approval #, Description of Waste, Volume/Weight, Expiration Date, Container Type. Row 1: 38251011244, Soil for disposal, 41.18 TN, 12-31-2011, Tractor with Dump Trailer(s).

*Attach Additional Sheet if necessary

I hereby certify that the above-described materials are non-hazardous wastes as defined by 40 CFR 261 or any applicable state law. Further, that the above named materials are properly classified, described, packaged, marked and labeled, and are in proper condition for transportation according to the applicable regulations of the Department of Transportation.

Susan Crowley (Signature)
Generator/Authorized Agent Name Signature Date Shipped

TRANSPORTER INFORMATION

Transporter Name: Las Vegas Paving DOT # 191949
Address: 4420 S. Decatur Truck Number: RD1
Las Vegas, NV 89103 Phone Number: (702) 353-4355

I certify no hazardous waste or other regulated substance was knowingly introduced to the waste while in my custody. The waste transported in this vehicle is the waste identified above, to the best of my knowledge.

Name of Authorized Agent (Signature) Signature Date Delivered 10/2/10

DISPOSAL SITE INFORMATION

Site Name: Apex Regional Landfill Phone No. (702) 599-5920
Address: 13550 U.S. Hwy 93 Las Vegas, NV

I hereby acknowledge receipt of the above described materials
Name (Print or Type) (Signature) Date Received 10/7/10

81 Environmental Tech
13550 N Highway 93
Las Vegas, NV 89165

Ticket Type: INBOUND INVOICE

Ticket Number: 2051
Date: 10/08/2010
Time In: 1:18 am
Time Out: 1:49 am

Customer: 001011 - NGE, LLC c/o Northgate Environ Mgmt

Vehicle/Container: 86113P
Contract: Northgate Env. On Site Soils 3825 11
Comment: 3825 10 11244

Gross Weight: 131,700 LB Manual In
Tare Weight: 55,240 LB Manual Out
Net Weight: 76460 LB
Net Tons: 38.23

BOL: 12137

Origin	Yards	Material	Billing	Quantity
Not Applicable	0.00 YD	SW CONTAMINATED SOIL	38.23	TN

Driver: _____

J. A. H.

Weighmaster: _____

SMITHJ

Indemnification. Customer agrees, by signature above, to indemnify, hold harmless, and defend Republic Services, Inc., its subsidiaries, affiliates, employees, officers and directors from and against any and all liabilities, claims, penalties, forfeitures, suits and the costs and expenses incident thereto, including costs of defense, settlement, and reasonable attorney's fees, which may be incurred, as a result of death or injuries to any person, or damage to any property, contamination of or adverse effects on the environment, caused in whole or in part by the Customer, its employees, or subcontractors in disposing waste at this Facility. In the event Customer delivers Unacceptable Waste (as determined by Republic) Customer agrees to assume all expenses and obligations with the removal and/or resolution of any effects caused by the delivery of such Unacceptable Waste.

Indemnización. Cliente acuerda indemnizar, mantener inmune, y defender Republic Services, Inc., sus subsidiarios, compañías, divisiones, empleados, oficiales y directores contra de cualquiera y de todas responsabilidades, demandas, penas, pérdidas, juicios, pleitos y los costos incidente además, incluyendo costos de defensa, de acuerdo judicial, y de honorarios razonables del abogado, que pueden ser incurridos en, o como resultado de, la muerte o herida personal a cualquier persona, o daños a cualquier característica, propiedad, contaminación de la tierra o efectos ilícitos en esta Facilidad, causado entero o en parte por el cliente, sus empleados, o sus subcontratistas en botar basura en esta Facilidad. En el caso que el Cliente entrega, bota, basura (según lo determinado por Republic) en este Establecimiento basura inaceptable en los reglamentos de este Establecimiento, el Cliente se compromete asumir todos los costos y obligaciones con el retiro y/o la resolución de cualquier dano(s) causado por la entrega de tal basura inaceptable.



NON-HAZARDOUS WASTE MANIFEST

MANIFEST # 12137

GENERATOR INFORMATION

Generator Name: Tronox LLC

Address: P.O. Box 55

City: Henderson County: Clark

State: NV Zip: 89009

Site Location (if different): 560 W. Lake Mead

Henderson, NV 89015 (702) 592-7727

CUSTOMER/BILLING INFORMATION

Billing Name: NGE LLC c/o Northgate Environment Management

Address: 300 Frank Ogawa Plaza, Ste 510

City: Oakland County: Alameda

State: CA Zip: 94612

Republic Services Approval #	Description of Waste	Volume/Weight	Expiration Date	Container Type
38251011244	Soil for disposal		12-31-2011	Tractor with Dump Trailer(s)
	RZ- _____ # _____	38.13 TW		

*Attach Additional Sheet if necessary

I hereby certify that the above-described materials are non-hazardous wastes as defined by 40 CFR 261 or any applicable state law. Further, that the above named materials are properly classified, described, packaged, marked and labeled, and are in proper condition for transportation according to the applicable regulations of the Department of Transportation.

Susan Crowley
Generator/Authorized Agent Name

Susan Crowley
Signature

Date Shipped

TRANSPORTER INFORMATION

Transporter Name: Las Vegas Paving

DOT # 191949

Address: 4420 S. Decatur

Truck Number: K0019/17

Las Vegas, NV 89103

Phone Number: (702) 353-4355

I certify no hazardous waste or other regulated substance was knowingly introduced to the waste while in my custody. The waste transported in this vehicle is the waste identified above, to the best of my knowledge.

Alberto
Name of Authorized Agent

Alberto
Signature

Oct 17, 2010
Date Delivered

DISPOSAL SITE INFORMATION

Site Name: Apex Regional Landfill

Phone No. (702) 599-5920

Address: 13550 U.S. Hwy 93 Las Vegas, NV

I hereby acknowledge receipt of the above described materials

Josua Smith
Name (Print or Type)

Signature

10-7-10
Date Received

81 Environmental Tech
13550 N Highway 93
Las Vegas, NV 89165

Ticket Type: INBOUND INVOICE

Ticket Number: 2052
Date: 10/08/2010
Time In: 1:35 am
Time Out: 2:02 am

Customer: 001011 - NGE, LLC c/o Northgate Environ Mgmt

Vehicle/Container: 192456
Contract: Northgate Env. On Site Soils 3825 11
Comment: 3825 10 11244

Gross Weight: 138,120 LB Manual In
Tare Weight: 53,300 LB Manual Out
Net Weight: 84820 LB
Net Tons: 42.41

BOL: 12140

Origin	Yards	Material	Billing	Quantity
Not Applicable	0.00 YD	SW CONTAMINATED SOIL	42.41	TN

Driver: 

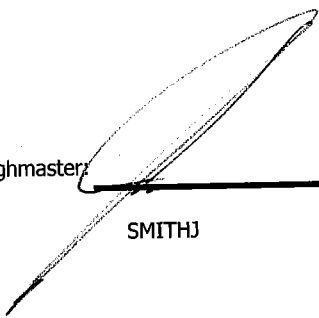
Weighmaster: 
SMITHJ

Indemnification. Customer agrees, by signature above, to indemnify, hold harmless, and defend Republic Services, Inc., its subsidiaries, affiliates, employees, officers and directors from and against any and all liabilities, claims, penalties, forfeitures, suits and the costs and expenses incident thereto, including costs of defense, settlement, and reasonable attorney's fees, which may be incurred, as a result of death or injuries to any person, or damage to any property, contamination of or adverse effects on the environment, caused in whole or in part by the Customer, its employees, or subcontractors in disposing waste at this Facility. In the event Customer delivers Unacceptable Waste (as determined by Republic) Customer agrees to assume all expenses and obligations with the removal and/or resolution of any effects caused by the delivery of such Unacceptable Waste.

Indemnización. Cliente acuerda indemnizar, mantener inmune, y defender Republic Services, Inc., sus subsidiarios, compañías, divisiones, empleados, oficiales y directores contra de cualquiera y de todas responsabilidades, demandas, penas, pérdidas, juicios, pleitos y los costos incidente además, incluyendo costos de defensa, de acuerdo judicial, y de honorarios razonables del abogado, que pueden ser incurridos en, o como resultado de, la muerte o herida personal a cualquier persona, o daños a cualquier característica, propiedad, contaminación de la tierra o efectos ilícitos en esta Facilidad, causado entero o en parte por el cliente, sus empleados, o sus subcontratistas en botar basura en esta Facilidad. En el caso que el Cliente entrega, bota, basura (según lo determinado por Republic) en este Establecimiento basura inaceptable en los reglamentos de este Establecimiento, el Cliente se compromete asumir todos los costos y obligaciones con el retiro y/o la resolución de cualquier dano(s) causado por la entrega de tal basura inaceptable.



NON-HAZARDOUS WASTE MANIFEST

MANIFEST # 12140

GENERATOR INFORMATION

Generator Name: Tronox LLCAddress: P.O. Box 55City: Henderson County: ClarkState: NV Zip: 89009Site Location (if different): 560 W. Lake MeadHenderson, NV 89015 (702) 592-7727

CUSTOMER/BILLING INFORMATION

Billing Name: NGE LLC c/o Northgate Environment ManagementAddress: 300 Frank Ogawa Plaza, Ste 510City: Oakland County: AlamedaState: CA Zip: 94612

Republic Services Approval #	Description of Waste	Volume/Weight	Expiration Date	Container Type
38251011244	Soil for disposal		12-31-2011	Tractor with Dump Trailer(s)
	RZ- _____ # _____	42.41 TN		

*Attach Additional Sheet if necessary

I hereby certify that the above-described materials are non-hazardous wastes as defined by 40 CFR 261 or any applicable state law. Further, that the above named materials are properly classified, described, packaged, marked and labeled, and are in proper condition for transportation according to the applicable regulations of the Department of Transportation.

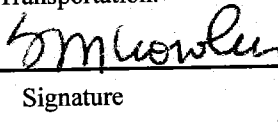
Susan Crowley 
 Generator/Authorized Agent Name Signature Date Shipped

TRANSPORTER INFORMATION

Transporter Name: Las Vegas PavingDOT # 191949Address: 4420 S. DecaturTruck Number: 192456Las Vegas, NV 89103Phone Number: (702) 353-4355

I certify no hazardous waste or other regulated substance was knowingly introduced to the waste while in my custody. The waste transported in this vehicle is the waste identified above, to the best of my knowledge.

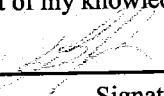
Blac 
 Name of Authorized Agent Signature Date Delivered

DISPOSAL SITE INFORMATION

Site Name: Apex Regional LandfillPhone No. (702) 599-5920Address: 13550 U.S. Hwy 93 Las Vegas, NV

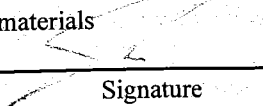
I hereby acknowledge receipt of the above described materials
Jesse Smith 
 Name (Print or Type) Signature Date Received

81 Environmental Tech
13550 N Highway 93
Las Vegas, NV 89165

Ticket Type: INBOUND INVOICE

Ticket Number: 2053
Date: 10/08/2010
Time In: 1:36 am
Time Out: 2:03 am

Customer: 001011 - NGE, LLC c/o Northgate Environ Mgmt

Vehicle/Container: 192460
Contract: Northgate Env. On Site Soils 3825 11
Comment: 3825 10 11244

Gross Weight: 125,120 LB Manual In
Tare Weight: 53,160 LB Manual Out
Net Weight: 71960 LB
Net Tons: 35.98

BOL: 12141

Origin	Yards	Material	Billing Quantity
Not Applicable	0.00 YD	SW CONTAMINATED SOIL	35.98 TN

Driver:

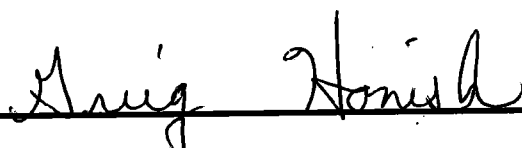

Weighmaster:

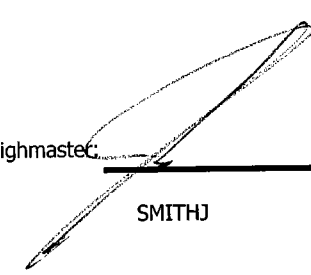

SMITHJ

Indemnification. Customer agrees, by signature above, to indemnify, hold harmless, and defend Republic Services, Inc., its subsidiaries, affiliates, employees, officers and directors from and against any and all liabilities, claims, penalties, forfeitures, suits and the costs and expenses incident thereto, including costs of defense, settlement, and reasonable attorney's fees, which may be incurred, as a result of death or injuries to any person, or damage to any property, contamination of or adverse effects on the environment, caused in whole or in part by the Customer, its employees, or subcontractors in disposing waste at this Facility. In the event Customer delivers Unacceptable Waste (as determined by Republic) Customer agrees to assume all expenses and obligations with the removal and/or resolution of any effects caused by the delivery of such Unacceptable Waste.

Indemnización. Cliente acuerda indemnizar, mantener inmune, y defender Republic Services, Inc., sus subsidiarios, compañías, divisiones, empleados, oficiales y directores contra de cualquiera y de todas responsabilidades, demandas, penas, pérdidas, juicios, pleitos y los costos incidente además, incluyendo costos de defensa, de acuerdo judicial, y de honorarios razonables del abogado, que pueden ser incurridos en, o como resultado de, la muerte o herida personal a cualquier persona, o daños a cualquier característica, propiedad, contaminación de la tierra o efectos ilícitos en esta Facilidad, causado entero o en parte por el cliente, sus empleados, o sus subcontratistas en botar basura en esta Facilidad. En el caso que el Cliente entrega, bota, basura (según lo determinado por Republic) en este Establecimiento basura inaceptable en los reglamentos de este Establecimiento, el Cliente se compromete asumir todos los costos y obligaciones con el retiro y/o la resolución de cualquier dano(s) causado por la entrega de tal basura inaceptable.



NON-HAZARDOUS WASTE MANIFEST

MANIFEST # 12141

GENERATOR INFORMATION

Generator Name: Tronox LLCAddress: P.O. Box 55City: Henderson County: ClarkState: NV Zip: 89009Site Location (if different): 560 W. Lake Mead
Henderson, NV 89015 (702) 592-7727

CUSTOMER/BILLING INFORMATION

Billing Name: NGE LLC c/o Northgate Environment ManagementAddress: 300 Frank Ogawa Plaza, Ste 510City: Oakland County: AlamedaState: CA Zip: 94612

Republic Services Approval #	Description of Waste	Volume/Weight	Expiration Date	Container Type
38251011244	Soil for disposal		12-31-2011	Tractor with Dump Trailer(s)
	RZ-_____ # _____	35.92 yd		

*Attach Additional Sheet if necessary

I hereby certify that the above-described materials are non-hazardous wastes as defined by 40 CFR 261 or any applicable state law. Further, that the above named materials are properly classified, described, packaged, marked and labeled, and are in proper condition for transportation according to the applicable regulations of the Department of Transportation.

Susan Crowley
Generator/Authorized Agent Name

Susan Crowley
Signature

Date Shipped

TRANSPORTER INFORMATION

Transporter Name: Las Vegas PavingDOT # 191949Address: 4420 S. DecaturTruck Number: 2460Las Vegas, NV 89103Phone Number: (702) 353-4355

I certify no hazardous waste or other regulated substance was knowingly introduced to the waste while in my custody. The waste transported in this vehicle is the waste identified above, to the best of my knowledge.

Gregg Horvath
Name of Authorized Agent

Gregg Horvath
Signature

10-7-10
Date Delivered

DISPOSAL SITE INFORMATION

Site Name: Apex Regional LandfillPhone No. (702) 599-5920Address: 13550 U.S. Hwy 93 Las Vegas, NV

I hereby acknowledge receipt of the above described materials

Name (Print or Type)

Signature

Date Received 10-7-10

81 Environmental Tech
13550 N Highway 93
Las Vegas, NV 89165

Ticket Type: INBOUND INVOICE

Ticket Number: 2054
Date: 10/08/2010
Time In: 1:41 am
Time Out: 2:06 am

Customer: 001011 - NGE, LLC c/o Northgate Environ Mgmt

Vehicle/Container: 192457
Contract: Northgate Env. On Site Soils 3825 11
Comment: 3825 10 11244

Gross Weight: 124,180 LB Manual In
Tare Weight: 52,000 LB Manual Out
Net Weight: 72180 LB
Net Tons: 36.09

BOL: 12143

Origin	Yards	Material	Billing	Quantity
Not Applicable	0.00 YD	SW CONTAMINATED SOIL	36.09	TN

Driver: 

Weighmaster: 

SMITHJ

Indemnification. Customer agrees, by signature above, to indemnify, hold harmless, and defend Republic Services, Inc., its subsidiaries, affiliates, employees, officers and directors from and against any and all liabilities, claims, penalties, forfeitures, suits and the costs and expenses incident thereto, including costs of defense, settlement, and reasonable attorney's fees, which may be incurred, as a result of death or injuries to any person, or damage to any property, contamination of or adverse effects on the environment, caused in whole or in part by the Customer, its employees, or subcontractors in disposing waste at this Facility. In the event Customer delivers Unacceptable Waste (as determined by Republic) Customer agrees to assume all expenses and obligations with the removal and/or resolution of any effects caused by the delivery of such Unacceptable Waste.

Indemnización. Cliente acuerda indemnizar, mantener inmune, y defender Republic Services, Inc., sus subsidiarios, compañías, divisiones, empleados, oficiales y directores contra de cualquiera y de todas responsabilidades, demandas, penas, pérdidas, juicios, pleitos y los costos incidente además, incluyendo costos de defensa, de acuerdo judicial, y de honorarios razonables del abogado, que pueden ser incurridos en, o como resultado de, la muerte o herida personal a cualquier persona, o daños a cualquier característica, propiedad, contaminación de la tierra o efectos ilícitos en esta Facilidad, causado entero o en parte por el cliente, sus empleados, o sus subcontratistas en botar basura en esta Facilidad. En el caso que el Cliente entrega, bota, basura (según lo determinado por Republic) en este Establecimiento basura inaceptable en los reglamentos de este Establecimiento, el Cliente se compromete asumir todos los costos y obligaciones con el retiro y/o la resolución de cualquier dano(s) causado por la entrega de tal basura inaceptable.



NON-HAZARDOUS WASTE MANIFEST

MANIFEST # 12143

GENERATOR INFORMATION

Generator Name: Tronox LLC

Address: P.O. Box 55

City: Henderson County: Clark

State: NV Zip: 89009

Site Location (if different): 560 W. Lake Mead

Henderson, NV 89015 (702) 592-7727

CUSTOMER/BILLING INFORMATION

Billing Name: NGE LLC c/o Northgate Environment Management

Address: 300 Frank Ogawa Plaza, Ste 510

City: Oakland County: Alameda

State: CA Zip: 94612

Republic Services Approval #	Description of Waste	Volume/Weight	Expiration Date	Container Type
38251011244	Soil for disposal		12-31-2011	Tractor with Dump Trailer(s)
	RZ-_____ # _____	26.09 TN		

*Attach Additional Sheet if necessary

I hereby certify that the above-described materials are non-hazardous wastes as defined by 40 CFR 261 or any applicable state law. Further, that the above named materials are properly classified, described, packaged, marked and labeled, and are in proper condition for transportation according to the applicable regulations of the Department of Transportation.

Susan Crowley
Generator/Authorized Agent Name

Susan Crowley
Signature

Date Shipped

TRANSPORTER INFORMATION

Transporter Name: Las Vegas Paving

DOT # 191949

Address: 4420 S. Decatur

Truck Number: 192457

Las Vegas, NV 89103

Phone Number: (702) 353-4355

I certify no hazardous waste or other regulated substance was knowingly introduced to the waste while in my custody. The waste transported in this vehicle is the waste identified above, to the best of my knowledge.

Brian R. K... ..
Name of Authorized Agent

Brian R. K...
Signature

10-7-10
Date Delivered

DISPOSAL SITE INFORMATION

Site Name: Apex Regional Landfill

Phone No. (702) 599-5920

Address: 13550 U.S. Hwy 93 Las Vegas, NV

I hereby acknowledge receipt of the above described materials

J. J.
Name (Print or Type)

Signature

10-7-10
Date Received

81 Environmental Tech
13550 N Highway 93
Las Vegas, NV 89165

Ticket Type: INBOUND INVOICE

Ticket Number: 2055
Date: 10/08/2010
Time In: 1:44 am
Time Out: 2:09 am

Customer: 001011 - NGE, LLC c/o Northgate Environ Mgmt

Vehicle/Container: 44166A
Contract: Northgate Env. On Site Soils 3825 11
Comment: 3825 10 11244

Gross Weight: 132,860 LB Manual In
Tare Weight: 57,380 LB Manual Out
Net Weight: 75480 LB
Net Tons: 37.74

BOL: 12142

Origin	Yards	Material	Billing Quantity
Not Applicable	0.00 YD	SW CONTAMINATED SOIL	37.74 TN

Driver: _____

Weighmaster: _____

SMITHJ

Indemnification. Customer agrees, by signature above, to indemnify, hold harmless, and defend Republic Services, Inc., its subsidiaries, affiliates, employees, officers and directors from and against any and all liabilities, claims, penalties, forfeitures, suits and the costs and expenses incident thereto, including costs of defense, settlement, and reasonable attorney's fees, which may be incurred, as a result of death or injuries to any person, or damage to any property, contamination of or adverse effects on the environment, caused in whole or in part by the Customer, its employees, or subcontractors in disposing waste at this Facility. In the event Customer delivers Unacceptable Waste (as determined by Republic) Customer agrees to assume all expenses and obligations with the removal and/or resolution of any effects caused by the delivery of such Unacceptable Waste.

Indemnización. Cliente acuerda indemnizar, mantener inmune, y defender Republic Services, Inc., sus subsidiarios, compañías, divisiones, empleados, oficiales y directores contra de cualquiera y de todas responsabilidades, demandas, penas, pérdidas, juicios, pleitos y los costos incidente además, incluyendo costos de defensa, de acuerdo judicial, y de honorarios razonables del abogado, que pueden ser incurridos en, o como resultado de, la muerte o herida personal a cualquier persona, o daños a cualquier característica, propiedad, contaminación de la tierra o efectos ilícitos en esta Facilidad, causado entero o en parte por el cliente, sus empleados, o sus subcontratistas en botar basura en esta Facilidad. En el caso que el Cliente entrega, bota, basura (según lo determinado por Republic) en este Establecimiento basura inaceptable en los reglamentos de este Establecimiento, el Cliente se compromete asumir todos los costos y obligaciones con el retiro y/o la resolución de cualquier dano(s) causado por la entrega de tal basura inaceptable.



NON-HAZARDOUS WASTE MANIFEST

MANIFEST # 12142

GENERATOR INFORMATION

Generator Name: Tronox LLC
Address: P.O. Box 55
City: Henderson County: Clark
State: NV Zip: 89009
Site Location (if different): 560 W. Lake Mead
Henderson, NV 89015 (702) 592-7727

CUSTOMER/BILLING INFORMATION

Billing Name: NGE LLC c/o Northgate Environment Management
Address: 300 Frank Ogawa Plaza, Ste 510
City: Oakland County: Alameda
State: CA Zip: 94612

Table with 5 columns: Republic Services Approval #, Description of Waste, Volume/Weight, Expiration Date, Container Type. Row 1: 38251011244, Soil for disposal, 37.79 TON, 12-31-2011, Tractor with Dump Trailer(s).

*Attach Additional Sheet if necessary

I hereby certify that the above-described materials are non-hazardous wastes as defined by 40 CFR 261 or any applicable state law. Further, that the above named materials are properly classified, described, packaged, marked and labeled, and are in proper condition for transportation according to the applicable regulations of the Department of Transportation.

Susan Crowley
Generator/Authorized Agent Name Signature Date Shipped

TRANSPORTER INFORMATION

Transporter Name: Las Vegas Paving DOT # 191949
Address: 4420 S. Decatur Truck Number: K002
Las Vegas, NV 89103 Phone Number: (702) 353-4355

I certify no hazardous waste or other regulated substance was knowingly introduced to the waste while in my custody. The waste transported in this vehicle is the waste identified above, to the best of my knowledge.

Hugo Pastorello
Name of Authorized Agent Signature Date Delivered

DISPOSAL SITE INFORMATION

Site Name: Apex Regional Landfill Phone No. (702) 599-5920
Address: 13550 U.S. Hwy 93 Las Vegas, NV

I hereby acknowledge receipt of the above described materials
Name (Print or Type) Signature Date Received

81 Environmental Tech
13550 N Highway 93
Las Vegas, NV 89165

Ticket Type: INBOUND INVOICE

Ticket Number: 2056
Date: 10/08/2010
Time In: 1:57 am
Time Out: 2:14 am

Customer: 001011 - NGE, LLC c/o Northgate Environ Mgmt

Vehicle/Container: 35903A
Contract: Northgate Env. On Site Soils 3825 11
Comment: 3825 10 11244

Gross Weight: 125,940 LB Manual In
Tare Weight: 57,640 LB Manual Out
Net Weight: 68300 LB
Net Tons: 34.15

BOL: 12145

Origin	Yards	Material	Billing	Quantity
Not Applicable	0.00 YD	SW CONTAMINATED SOIL	34.15	TN

Driver:

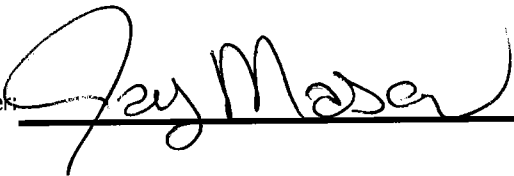

Weighmaster:



SMITHJ

Indemnification. Customer agrees, by signature above, to indemnify, hold harmless, and defend Republic Services, Inc., its subsidiaries, affiliates, employees, officers and directors from and against any and all liabilities, claims, penalties, forfeitures, suits and the costs and expenses incident thereto, including costs of defense, settlement, and reasonable attorney's fees, which may be incurred, as a result of death or injuries to any person, or damage to any property, contamination of or adverse effects on the environment, caused in whole or in part by the Customer, its employees, or subcontractors in disposing waste at this Facility. In the event Customer delivers Unacceptable Waste (as determined by Republic) Customer agrees to assume all expenses and obligations with the removal and/or resolution of any effects caused by the delivery of such Unacceptable Waste.

Indemnización. Cliente acuerda indemnizar, mantener inmune, y defender Republic Services, Inc., sus subsidiarios, compañías, divisiones, empleados, oficiales y directores contra de cualquiera y de todas responsabilidades, demandas, penas, pérdidas, juicios, pleitos y los costos incidente además, incluyendo costos de defensa, de acuerdo judicial, y de honorarios razonables del abogado, que pueden ser incurridos en, o como resultado de, la muerte o herida personal a cualquier persona, o daños a cualquier característica, propiedad, contaminación de la tierra o efectos ilícitos en esta Facilidad. En el caso que el Cliente entrega, bota, basura (según lo determinado por Republic) en este Establecimiento basura inaceptable en los reglamentos de este Establecimiento, el Cliente se compromete asumir todos los costos y obligaciones con el retiro y/o la resolución de cualquier dano(s) causado por la entrega de tal basura inaceptable.



NON-HAZARDOUS WASTE MANIFEST

MANIFEST # 12145

GENERATOR INFORMATION

Generator Name: Tronox LLC

Address: P.O. Box 55

City: Henderson County: Clark

State: NV Zip: 89009

Site Location (if different): 560 W. Lake Mead

Henderson, NV 89015 (702) 592-7727

CUSTOMER/BILLING INFORMATION

Billing Name: NGE LLC c/o Northgate Environment Management

Address: 300 Frank Ogawa Plaza, Ste 510

City: Oakland County: Alameda

State: CA Zip: 94612

Republic Services Approval #	Description of Waste	Volume/Weight	Expiration Date	Container Type
38251011244	Soil for disposal		12-31-2011	Tractor with Dump Trailer(s)
	RZ- #	34.15	7/10	

*Attach Additional Sheet if necessary

I hereby certify that the above-described materials are non-hazardous wastes as defined by 40 CFR 261 or any applicable state law. Further, that the above named materials are properly classified, described, packaged, marked and labeled, and are in proper condition for transportation according to the applicable regulations of the Department of Transportation.

Susan Crowley (Signature) Date Shipped

TRANSPORTER INFORMATION

Transporter Name: Las Vegas Paving

DOT # 191949

Address: 4420 S. Decatur

Truck Number: 07

Las Vegas, NV 89103

Phone Number: (702) 353-4355

I certify no hazardous waste or other regulated substance was knowingly introduced to the waste while in my custody. The waste transported in this vehicle is the waste identified above, to the best of my knowledge.

WardcoBC (Signature) Date Delivered 10-8-10

DISPOSAL SITE INFORMATION

Site Name: Apex Regional Landfill

Phone No. (702) 599-5920

Address: 13550 U.S. Hwy 93 Las Vegas, NV

I hereby acknowledge receipt of the above described materials

Josiah Smith (Signature) Date Received 10-8-10

81 Environmental Tech
13550 N Highway 93
Las Vegas, NV 89165

Ticket Type: INBOUND INVOICE

Ticket Number: 2057
Date: 10/08/2010
Time In: 1:57 am
Time Out: 2:21 am

Customer: 001011 - NGE, LLC c/o Northgate Environ Mgmt

Vehicle/Container: 81495P
Contract: Northgate Env. On Site Soils 3825 14
Comment: 3825 10 11244

Gross Weight: 125,640 LB Manual In
Tare Weight: 51,440 LB Manual Out
Net Weight: 74200 LB
Net Tons: 37.10

BOL: 12144

Origin	Yards	Material	Billing	Quantity
Not Applicable	0.00 YD	SW CONTAMINATED SOIL	37.10	TN

Driver: _____



Weighmaster: _____

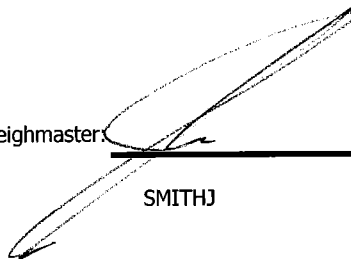

SMITHJ

Indemnification. Customer agrees, by signature above, to indemnify, hold harmless, and defend Republic Services, Inc., its subsidiaries, affiliates, employees, officers and directors from and against any and all liabilities, claims, penalties, forfeitures, suits and the costs and expenses incident thereto, including costs of defense, settlement, and reasonable attorney's fees, which may be incurred, as a result of death or injuries to any person, or damage to any property, contamination of or adverse effects on the environment, caused in whole or in part by the Customer, its employees, or subcontractors in disposing waste at this Facility. In the event Customer delivers Unacceptable Waste (as determined by Republic) Customer agrees to assume all expenses and obligations with the removal and/or resolution of any effects caused by the delivery of such Unacceptable Waste.

Indemnización. Cliente acuerda indemnizar, mantener inmune, y defender Republic Services, Inc., sus subsidiarios, compañías, divisiones, empleados, oficiales y directores contra de cualquiera y de todas responsabilidades, demandas, penas, pérdidas, juicios, pleitos y los costos incidente además, incluyendo costos de defensa, de acuerdo judicial, y de honorarios razonables del abogado, que pueden ser incurridos en, o como resultado de, la muerte o herida personal a cualquier persona, o daños a cualquier característica, propiedad, contaminación de la tierra o efectos ilícitos en esta Facilidad, causado entero o en parte por el cliente, sus empleados, o sus subcontratistas en botar basura en esta Facilidad. En el caso que el Cliente entrega, bota, basura (según lo determinado por Republic) en este Establecimiento basura inaceptable en los reglamentos de este Establecimiento, el Cliente se compromete asumir todos los costos y obligaciones con el retiro y/o la resolución de cualquier dano(s) causado por la entrega de tal basura inaceptable.



SR 40238

NON-HAZARDOUS WASTE MANIFEST

MANIFEST # 12144

GENERATOR INFORMATION

Generator Name: Tronox LLC

Address: P.O. Box 55

City: Henderson County: Clark

State: NV Zip: 89009

Site Location (if different): 560 W. Lake Mead

Henderson, NV 89015 (702) 592-7727

CUSTOMER/BILLING INFORMATION

Billing Name: NGE LLC c/o Northgate Environment Management

Address: 300 Frank Ogawa Plaza, Ste 510

City: Oakland County: Alameda

State: CA Zip: 94612

Republic Services Approval #	Description of Waste	Volume/Weight	Expiration Date	Container Type
38251011244	Soil for disposal		12-31-2011	Tractor with Dump Trailer(s)
	RZ- _____ # _____	37.10 TO		

*Attach Additional Sheet if necessary

I hereby certify that the above-described materials are non-hazardous wastes as defined by 40 CFR 261 or any applicable state law. Further, that the above named materials are properly classified, described, packaged, marked and labeled, and are in proper condition for transportation according to the applicable regulations of the Department of Transportation.

Susan Crowley [Signature] _____
 Generator/Authorized Agent Name Signature Date Shipped

TRANSPORTER INFORMATION

Transporter Name: Las Vegas Paving

DOT # 191949

Address: 4420 S. Decatur

Truck Number: 175

Las Vegas, NV 89103

Phone Number: (702) 353-4355

I certify no hazardous waste or other regulated substance was knowingly introduced to the waste while in my custody. The waste transported in this vehicle is the waste identified above, to the best of my knowledge.

Larry Harris [Signature] 10-7-10
 Name of Authorized Agent Signature Date Delivered

DISPOSAL SITE INFORMATION

Site Name: Apex Regional Landfill

Phone No. (702) 599-5920

Address: 13550 U.S. Hwy 93 Las Vegas, NV

I hereby acknowledge receipt of the above described materials
Jesse Smith [Signature] 10-8-10
 Name (Print or Type) Signature Date Received

81 Environmental Tech
13550 N Highway 93
Las Vegas, NV 89165

Ticket Type: INBOUND INVOICE

Ticket Number: 2058
Date: 10/08/2010
Time In: 2:10 am
Time Out: 2:33 am

Customer: 001011 - NGE, LLC c/o Northgate Environ Mgmt

Vehicle/Container: 81496P
Contract: Northgate Env. On Site Soils 3825 11
Comment: 3825 10 11244

Gross Weight: 118,340 LB Manual In
Tare Weight: 50,660 LB Manual Out
Net Weight: 67680 LB
Net Tons: 33.84

BOL: 12146

Origin	Yards	Material	Billing Quantity
Not Applicable	0.00 YD	SW CONTAMINATED SOIL	33.84 TN

Driver: _____

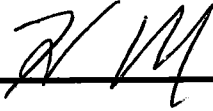

Weighmaster: _____

SMITHJ

Indemnification. Customer agrees, by signature above, to indemnify, hold harmless, and defend Republic Services, Inc., its subsidiaries, affiliates, employees, officers and directors from and against any and all liabilities, claims, penalties, forfeitures, suits and the costs and expenses incident thereto, including costs of defense, settlement, and reasonable attorney's fees, which may be incurred, as a result of death or injuries to any person, or damage to any property, contamination of or adverse effects on the environment, caused in whole or in part by the Customer, its employees, or subcontractors in disposing waste at this Facility. In the event Customer delivers Unacceptable Waste (as determined by Republic) Customer agrees to assume all expenses and obligations with the removal and/or resolution of any effects caused by the delivery of such Unacceptable Waste.

Indemnización. Cliente acuerda indemnizar, mantener inmune, y defender Republic Services, Inc., sus subsidiarios, compañías, divisiones, empleados, oficiales y directores contra de cualquiera y de todas responsabilidades, demandas, penas, pérdidas, juicios, pleitos y los costos incidente además, incluyendo costos de defensa, de acuerdo judicial, y de honorarios razonables del abogado, que pueden ser incurridos en, o como resultado de, la muerte o herida personal a cualquier persona, o daños a cualquier característica, propiedad, contaminación de la tierra o efectos ilícitos en esta Facilidad, causado entero o en parte por el cliente, sus empleados, o sus subcontratistas en botar basura en esta Facilidad. En el caso que el Cliente entrega, bota, basura (según lo determinado por Republic) en este Establecimiento basura inaceptable en los reglamentos de este Establecimiento, el Cliente se compromete asumir todos los costos y obligaciones con el retiro y/o la resolución de cualquier dano(s) causado por la entrega de tal basura inaceptable.



NON-HAZARDOUS WASTE MANIFEST

MANIFEST # 12146

GENERATOR INFORMATION

Generator Name: Tronox LLCAddress: P.O. Box 55City: Henderson County: ClarkState: NV Zip: 89009Site Location (if different): 560 W. Lake MeadHenderson, NV 89015 (702) 592-7727

CUSTOMER/BILLING INFORMATION

Billing Name: NGE LLC c/o Northgate Environment ManagementAddress: 300 Frank Ogawa Plaza, Ste 510City: Oakland County: AlamedaState: CA Zip: 94612

Republic Services Approval #	Description of Waste	Volume/Weight	Expiration Date	Container Type
38251011244	Soil for disposal		12-31-2011	Tractor with Dump Trailer(s)
	RZ- _____ # _____	33.84 TON		

*Attach Additional Sheet if necessary

I hereby certify that the above-described materials are non-hazardous wastes as defined by 40 CFR 261 or any applicable state law. Further, that the above named materials are properly classified, described, packaged, marked and labeled, and are in proper condition for transportation according to the applicable regulations of the Department of Transportation.

Susan Crowley
 Generator/Authorized Agent Name

Susan Crowley
 Signature

Date Shipped

TRANSPORTER INFORMATION

Transporter Name: Las Vegas PavingDOT # 191949Address: 4420 S. DecaturTruck Number: 145Las Vegas, NV 89103Phone Number: (702) 353-4355

I certify no hazardous waste or other regulated substance was knowingly introduced to the waste while in my custody. The waste transported in this vehicle is the waste identified above, to the best of my knowledge.

Harry M. Biel
 Name of Authorized Agent

Harry M. Biel
 Signature

10-8-10
 Date Delivered

DISPOSAL SITE INFORMATION

Site Name: Apex Regional LandfillPhone No. (702) 599-5920Address: 13550 U.S. Hwy 93 Las Vegas, NV

I hereby acknowledge receipt of the above described materials

JASON SMITH
 Name (Print or Type)

Signature

10-8-10
 Date Received

81 Environmental Tech
13550 N Highway 93
Las Vegas, NV 89165

Ticket Type: INBOUND INVOICE

Ticket Number: 2059
Date: 10/08/2010
Time In: 2:14 am
Time Out: 2:37 am

Customer: 001011 - NGE, LLC c/o Northgate Environ Mgmt

Vehicle/Container: 34330A
Contract: Northgate Env. On Site Soils 3825 11
Comment: 3825 10 11244

Gross Weight: 118,040 LB Manual In
Tare Weight: 53,420 LB Manual Out
Net Weight: 64620 LB
Net Tons: 32.31

BOL: 12147

Origin	Yards	Material	Billing	Quantity
Not Applicable	0.00 YD	SW CONTAMINATED SOIL	32.31	TN

Driver:

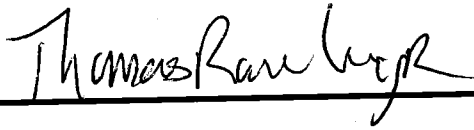

Weighmaster:



SMITHJ

Indemnification. Customer agrees, by signature above, to indemnify, hold harmless, and defend Republic Services, Inc., its subsidiaries, affiliates, employees, officers and directors from and against any and all liabilities, claims, penalties, forfeitures, suits and the costs and expenses incident thereto, including costs of defense, settlement, and reasonable attorney's fees, which may be incurred, as a result of death or injuries to any person, or damage to any property, contamination of or adverse effects on the environment, caused in whole or in part by the Customer, its employees, or subcontractors in disposing waste at this Facility. In the event Customer delivers Unacceptable Waste (as determined by Republic) Customer agrees to assume all expenses and obligations with the removal and/or resolution of any effects caused by the delivery of such Unacceptable Waste.

Indemnización. Cliente acuerda indemnizar, mantener inmune, y defender Republic Services, Inc., sus subsidiarios, compañías, divisiones, empleados, oficiales y directores contra de cualquiera y de todas responsabilidades, demandas, penas, pérdidas, juicios, pleitos y los costos incidente además, incluyendo costos de defensa, de acuerdo judicial, y de honorarios razonables del abogado, que pueden ser incurridos en, o como resultado de, la muerte o herida personal a cualquier persona, o daños a cualquier característica, propiedad, contaminación de la tierra o efectos ilícitos en esta Facilidad, causado entero o en parte por el cliente, sus empleados, o sus subcontratistas en botar basura en esta Facilidad. En el caso que el Cliente entrega, bota, basura (según lo determinado por Republic) en este Establecimiento basura inaceptable en los reglamentos de este Establecimiento, el Cliente se compromete asumir todos los costos y obligaciones con el retiro y/o la resolución de cualquier dano(s) causado por la entrega de tal basura inaceptable.



NON-HAZARDOUS WASTE MANIFEST

MANIFEST # 12147

GENERATOR INFORMATION

Generator Name: Tronox LLC

Address: P.O. Box 55

City: Henderson County: Clark

State: NV Zip: 89009

Site Location (if different): 560 W. Lake Mead

Henderson, NV 89015 (702) 592-7727

CUSTOMER/BILLING INFORMATION

Billing Name: NGE LLC c/o Northgate Environment Management

Address: 300 Frank Ogawa Plaza, Ste 510

City: Oakland County: Alameda

State: CA Zip: 94612

Republic Services Approval #	Description of Waste	Volume/Weight	Expiration Date	Container Type
38251011244	Soil for disposal		12-31-2011	Tractor with Dump Trailer(s)
	RZ- _____ # _____	32.3100		

*Attach Additional Sheet if necessary

I hereby certify that the above-described materials are non-hazardous wastes as defined by 40 CFR 261 or any applicable state law. Further, that the above named materials are properly classified, described, packaged, marked and labeled, and are in proper condition for transportation according to the applicable regulations of the Department of Transportation.

Susan Crowley
Generator/Authorized Agent Name

[Signature]
Signature

Date Shipped

TRANSPORTER INFORMATION

Transporter Name: Las Vegas Paving

DOT # 191949

Address: 4420 S. Decatur

Truck Number: 981

Las Vegas, NV 89103

Phone Number: (702) 353-4355

I certify no hazardous waste or other regulated substance was knowingly introduced to the waste while in my custody. The waste transported in this vehicle is the waste identified above, to the best of my knowledge.

[Signature]
Name of Authorized Agent

[Signature]
Signature

10-8-10
Date Delivered

DISPOSAL SITE INFORMATION

Site Name: Apex Regional Landfill

Phone No. (702) 599-5920

Address: 13550 U.S. Hwy 93 Las Vegas, NV

I hereby acknowledge receipt of the above described materials

[Signature]
Name (Print or Type)

Signature

10-8-10
Date Received

81 Environmental Tech
13550 N Highway 93
Las Vegas, NV 89165

Ticket Type: INBOUND INVOICE

Ticket Number: 2060
Date: 10/08/2010
Time In: 2:21 am
Time Out: 2:45 am

Customer: 001011 - NGE, LLC c/o Northgate Environ Mgmt

Vehicle/Container: 81460P
Contract: Northgate Env. On Site Soils 3825 11
Comment: 3825 10 11244

Gross Weight: 123,040 LB Manual In
Tare Weight: 55,540 LB Manual Out
Net Weight: 67,500 LB
Net Tons: 33.75

BOL: 12149

Origin	Yards	Material	Billing Quantity
Not Applicable	0.00 YD	SW CONTAMINATED SOIL	33.75 TN

Driver:



Weighmaster:

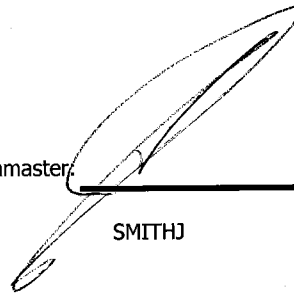

SMITHJ

Indemnification. Customer agrees, by signature above, to indemnify, hold harmless, and defend Republic Services, Inc., its subsidiaries, affiliates, employees, officers and directors from and against any and all liabilities, claims, penalties, forfeitures, suits and the costs and expenses incident thereto, including costs of defense, settlement, and reasonable attorney's fees, which may be incurred, as a result of death or injuries to any person, or damage to any property, contamination of or adverse effects on the environment, caused in whole or in part by the Customer, its employees, or subcontractors in disposing waste at this Facility. In the event Customer delivers Unacceptable Waste (as determined by Republic) Customer agrees to assume all expenses and obligations with the removal and/or resolution of any effects caused by the delivery of such Unacceptable Waste.

Indemnización. Cliente acuerda indemnizar, mantener inmune, y defender Republic Services, Inc., sus subsidiarios, compañías, divisiones, empleados, oficiales y directores contra de cualquiera y de todas responsabilidades, demandas, penas, pérdidas, juicios, pleitos y los costos incidente además, incluyendo costos de defensa, de acuerdo judicial, y de honorarios razonables del abogado, que pueden ser incurridos en, o como resultado de, la muerte o herida personal a cualquier persona, o daños a cualquier característica, propiedad, contaminación de la tierra o efectos ilícitos en esta Facilidad, causado entero o en parte por el cliente, sus empleados, o sus subcontratistas en botar basura en esta Facilidad. En el caso que el Cliente entrega, bota, basura (según lo determinado por Republic) en este Establecimiento basura inaceptable en los reglamentos de este Establecimiento, el Cliente se compromete asumir todos los costos y obligaciones con el retiro y/o la resolución de cualquier dano(s) causado por la entrega de tal basura inaceptable.



NON-HAZARDOUS WASTE MANIFEST

MANIFEST # 12149

GENERATOR INFORMATION

Generator Name: Tronox LLC

Address: P.O. Box 55

City: Henderson County: Clark

State: NV Zip: 89009

Site Location (if different): 560 W. Lake Mead
Henderson, NV 89015 (702) 592-7727

CUSTOMER/BILLING INFORMATION

Billing Name: NGE LLC c/o Northgate Environment Management

Address: 300 Frank Ogawa Plaza, Ste 510

City: Oakland County: Alameda

State: CA Zip: 94612

Table with 5 columns: Republic Services Approval #, Description of Waste, Volume/Weight, Expiration Date, Container Type. Row 1: 38251011244, Soil for disposal, 3.75, 12-31-2011, Tractor with Dump Trailer(s). Row 2: RZ- #

*Attach Additional Sheet if necessary

I hereby certify that the above-described materials are non-hazardous wastes as defined by 40 CFR 261 or any applicable state law. Further, that the above named materials are properly classified, described, packaged, marked and labeled, and are in proper condition for transportation according to the applicable regulations of the Department of Transportation.

Susan Crowley Generator/Authorized Agent Name Signature Date Shipped

TRANSPORTER INFORMATION

Transporter Name: Las Vegas Paving

DOT # 191949

Address: 4420 S. Decatur

Truck Number: 27

Las Vegas, NV 89103

Phone Number: (702) 353-4355

I certify no hazardous waste or other regulated substance was knowingly introduced to the waste while in my custody. The waste transported in this vehicle is the waste identified above, to the best of my knowledge.

Daniel Cardenas Name of Authorized Agent Signature Date Delivered 10-07-2010

DISPOSAL SITE INFORMATION

Site Name: Apex Regional Landfill

Phone No. (702) 599-5920

Address: 13550 U.S. Hwy 93 Las Vegas, NV

I hereby acknowledge receipt of the above described materials

Name (Print or Type) Signature Date Received

81 Environmental Tech
13550 N Highway 93
Las Vegas, NV 89165

Ticket Type: INBOUND INVOICE

Ticket Number: 2061
Date: 10/08/2010
Time In: 2:24 am
Time Out: 2:47 am

Customer: 001011 - NGE, LLC c/o Northgate Environ Mgmt

Vehicle/Container: 86053P
Contract: Northgate Env. On Site Soils 3825 11
Comment: 3825 10 11244

Gross Weight: 116,420 LB Manual In
Tare Weight: 57,380 LB Manual Out
Net Weight: 59,040 LB
Net Tons: 29.52

BOL: 12150

Origin	Yards	Material	Billing	Quantity
Not Applicable	0.00 YD	SW CONTAMINATED SOIL	29.52	TN

Driver: _____



Weighmaster: _____

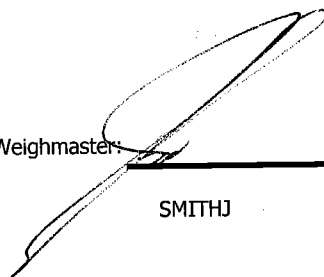

SMITHJ

Indemnification. Customer agrees, by signature above, to indemnify, hold harmless, and defend Republic Services, Inc., its subsidiaries, affiliates, employees, officers and directors from and against any and all liabilities, claims, penalties, forfeitures, suits and the costs and expenses incident thereto, including costs of defense, settlement, and reasonable attorney's fees, which may be incurred, as a result of death or injuries to any person, or damage to any property, contamination of or adverse effects on the environment, caused in whole or in part by the Customer, its employees, or subcontractors in disposing waste at this Facility. In the event Customer delivers Unacceptable Waste (as determined by Republic) Customer agrees to assume all expenses and obligations with the removal and/or resolution of any effects caused by the delivery of such Unacceptable Waste.

Indemnización. Cliente acuerda indemnizar, mantener inmune, y defender Republic Services, Inc., sus subsidiarios, compañías, divisiones, empleados, oficiales y directores contra de cualquiera y de todas responsabilidades, demandas, penas, pérdidas, juicios, pleitos y los costos incidente además, incluyendo costos de defensa, de acuerdo judicial, y de honorarios razonables del abogado, que pueden ser incurridos en, o como resultado de, la muerte o herida personal a cualquier persona, o daños a cualquier característica, propiedad, contaminación de la tierra o efectos ilícitos en esta Facilidad, causado entero o en parte por el cliente, sus empleados, o sus subcontratistas en botar basura en esta Facilidad. En el caso que el Cliente entrega, bota, basura (según lo determinado por Republic) en este Establecimiento basura inaceptable en los reglamentos de este Establecimiento, el Cliente se compromete asumir todos los costos y obligaciones con el retiro y/o la resolución de cualquier dano(s) causado por la entrega de tal basura inaceptable.



NON-HAZARDOUS WASTE MANIFEST

MANIFEST # 12150

GENERATOR INFORMATION

Generator Name: Tronox LLC

Address: P.O. Box 55

City: Henderson County: Clark

State: NV Zip: 89009

Site Location (if different): 560 W. Lake Mead
Henderson, NV 89015 (702) 592-7727

CUSTOMER/BILLING INFORMATION

Billing Name: NGE LLC c/o Northgate Environment Management

Address: 300 Frank Ogawa Plaza, Ste 510

City: Oakland County: Alameda

State: CA Zip: 94612

Table with 5 columns: Republic Services Approval #, Description of Waste, Volume/Weight, Expiration Date, Container Type. Row 1: 38251011244, Soil for disposal, 2952, 12-31-2011, Tractor with Dump Trailer(s). Row 2: RZ- #

*Attach Additional Sheet if necessary

I hereby certify that the above-described materials are non-hazardous wastes as defined by 40 CFR 261 or any applicable state law. Further, that the above named materials are properly classified, described, packaged, marked and labeled, and are in proper condition for transportation according to the applicable regulations of the Department of Transportation.

Susan Crowley (Signature)
Generator/Authorized Agent Name Signature Date Shipped

TRANSPORTER INFORMATION

Transporter Name: Las Vegas Paving DOT # 191949

Address: 4420 S. Decatur Truck Number: 261

Las Vegas, NV 89103 Phone Number: (702) 353-4355

I certify no hazardous waste or other regulated substance was knowingly introduced to the waste while in my custody. The waste transported in this vehicle is the waste identified above, to the best of my knowledge.

(Signature) (Signature) 7 OCT 10
Name of Authorized Agent Signature Date Delivered

DISPOSAL SITE INFORMATION

Site Name: Apex Regional Landfill Phone No. (702) 599-5920

Address: 13550 U.S. Hwy 93 Las Vegas, NV

I hereby acknowledge receipt of the above described materials
Jesse Smith (Signature) 10-8-10
Name (Print or Type) Signature Date Received

81 Environmental Tech
13550 N Highway 93
Las Vegas, NV 89165

Ticket Type: INBOUND INVOICE

Ticket Number: 2062
Date: 10/08/2010
Time In: 2:29 am
Time Out: 2:49 am

Customer: 001011 - NGE, LLC c/o Northgate Environ Mgmt

Vehicle/Container: 82418P
Contract: Northgate Env. On Site Soils 3825 11
Comment: 3825 10 11244

Gross Weight: 133,520 LB Manual In
Tare Weight: 60,540 LB Manual Out
Net Weight: 72,980 LB
Net Tons: 36.49

BOL: 12148

Origin	Yards	Material	Billing	Quantity
Not Applicable	0.00 YD	SW CONTAMINATED SOIL	36.49	TN

Driver: _____

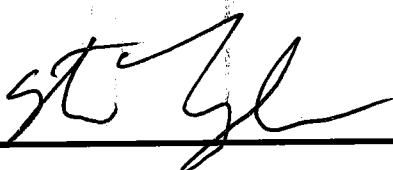

Weighmaster: _____

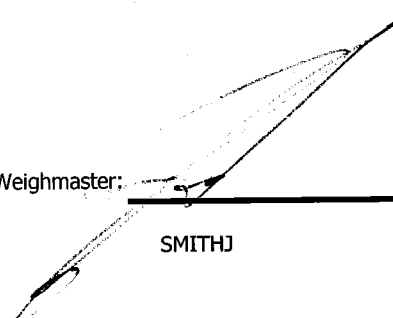

SMITHJ

Indemnification. Customer agrees, by signature above, to indemnify, hold harmless, and defend Republic Services, Inc., its subsidiaries, affiliates, employees, officers and directors from and against any and all liabilities, claims, penalties, forfeitures, suits and the costs and expenses incident thereto, including costs of defense, settlement, and reasonable attorney's fees, which may be incurred, as a result of death or injuries to any person, or damage to any property, contamination of or adverse effects on the environment, caused in whole or in part by the Customer, its employees, or subcontractors in disposing waste at this Facility. In the event Customer delivers Unacceptable Waste (as determined by Republic) Customer agrees to assume all expenses and obligations with the removal and/or resolution of any effects caused by the delivery of such Unacceptable Waste.

Indemnización. Cliente acuerda indemnizar, mantener inmune, y defender Republic Services, Inc., sus subsidiarios, compañías, divisiones, empleados, oficiales y directores contra de cualquiera y de todas responsabilidades, demandas, penas, pérdidas, juicios, pleitos y los costos incidente además, incluyendo costos de defensa, de acuerdo judicial, y de honorarios razonables del abogado, que pueden ser incurridos en, o como resultado de, la muerte o herida personal a cualquier persona, o daños a cualquier característica, propiedad, contaminación de la tierra o efectos ilícitos en esta Facilidad, causado entero o en parte por el cliente, sus empleados, o sus subcontratistas en botar basura en esta Facilidad. En el caso que el Cliente entrega, bota, basura (según lo determinado por Republic) en este Establecimiento basura inaceptable en los reglamentos de este Establecimiento, el Cliente se compromete asumir todos los costos y obligaciones con el retiro y/o la resolución de cualquier dano(s) causado por la entrega de tal basura inaceptable.



NON-HAZARDOUS WASTE MANIFEST

MANIFEST # 12148

GENERATOR INFORMATION

Generator Name: Tronox LLCAddress: P.O. Box 55City: Henderson County: ClarkState: NV Zip: 89009Site Location (if different): 560 W. Lake MeadHenderson, NV 89015 (702) 592-7727

CUSTOMER/BILLING INFORMATION

Billing Name: NGE LLC c/o Northgate Environment ManagementAddress: 300 Frank Ogawa Plaza, Ste 510City: Oakland County: AlamedaState: CA Zip: 94612

Republic Services Approval #	Description of Waste	Volume/Weight	Expiration Date	Container Type
38251011244	Soil for disposal		12-31-2011	Tractor with Dump Trailer(s)
	RZ- _____ # _____	36.8970		

*Attach Additional Sheet if necessary

I hereby certify that the above-described materials are non-hazardous wastes as defined by 40 CFR 261 or any applicable state law. Further, that the above named materials are properly classified, described, packaged, marked and labeled, and are in proper condition for transportation according to the applicable regulations of the Department of Transportation.

Susan Crowley
Generator/Authorized Agent NameSusan Crowley
Signature

Date Shipped

TRANSPORTER INFORMATION

Transporter Name: Las Vegas PavingDOT # 191949Address: 4420 S. DecaturTruck Number: 220Las Vegas, NV 89103Phone Number: (702) 353-4355

I certify no hazardous waste or other regulated substance was knowingly introduced to the waste while in my custody. The waste transported in this vehicle is the waste identified above, to the best of my knowledge.

STEVE TAYLOR
Name of Authorized AgentSteve Taylor
Signature10-7-10
Date Delivered

DISPOSAL SITE INFORMATION

Site Name: Apex Regional LandfillPhone No. (702) 599-5920Address: 13550 U.S. Hwy 93 Las Vegas, NV

I hereby acknowledge receipt of the above described materials

Josie Smith
Name (Print or Type)Josie Smith
Signature10-8-10
Date Received

81 Environmental Tech
13550 N Highway 93
Las Vegas, NV 89165

Ticket Type: INBOUND INVOICE

Ticket Number: 2063
Date: 10/08/2010
Time In: 2:31 am
Time Out: 2:53 am

Customer: 001011 - NGE, LLC c/o Northgate Environ Mgmt

Vehicle/Container: 81494P
Contract: Northgate Env. On Site Soils 3825 11
Comment: 3825 10 11244

Gross Weight: 121,580 LB Manual In
Tare Weight: 51,200 LB Manual Out
Net Weight: 70380 LB
Net Tons: 35.19

BOL: 12152

Origin	Yards	Material	Billing Quantity
Not Applicable	0.00 YD	SW CONTAMINATED SOIL	35.19 TN

Driver: _____

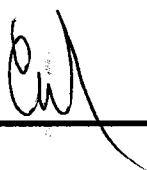

Weighmaster: _____

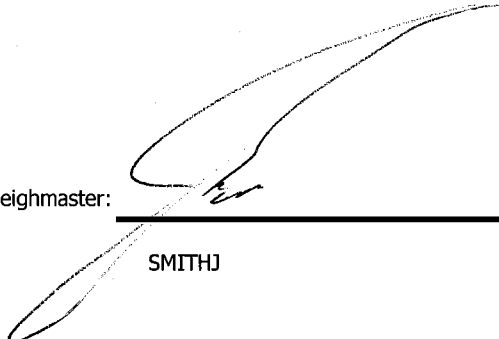

SMITHJ

Indemnification. Customer agrees, by signature above, to indemnify, hold harmless, and defend Republic Services, Inc., its subsidiaries, affiliates, employees, officers and directors from and against any and all liabilities, claims, penalties, forfeitures, suits and the costs and expenses incident thereto, including costs of defense, settlement, and reasonable attorney's fees, which may be incurred, as a result of death or injuries to any person, or damage to any property, contamination of or adverse effects on the environment, caused in whole or in part by the Customer, its employees, or subcontractors in disposing waste at this Facility. In the event Customer delivers Unacceptable Waste (as determined by Republic) Customer agrees to assume all expenses and obligations with the removal and/or resolution of any effects caused by the delivery of such Unacceptable Waste.

Indemnización. Cliente acuerda indemnizar, mantener inmune, y defender Republic Services, Inc., sus subsidiarios, companias, divisiones, empleados, oficiales y directores contra de cualquiera y de todas responsabilidades, demandas, penas, pérdidas, juicios, pleitos y los costos incidente además, incluyendo costos de defensa, de acuerdo judicial, y de honorarios razonables del abogado, que pueden ser incurridos en, o como resultado de, la muerte o herida personal a cualquier persona, o daños a cualquier característica, propiedad, contaminación de la tierra o efectos ilicitos en esta Facilidad, causado entero o en parte por el cliente, sus empleados, o sus subcontratistas en botar basura en esta Facilidad. En el caso que el Cliente entrega, bota, basura (según lo determinado por Republic) en este Establecimiento basura inaceptable en los reglamentos de este Establecimiento, el Cliente se compromete asumir todos los costos y obligaciones con el retiro y/o la resolución de cualquier dano(s) causado por la entrega de tal basura inaceptable.



NON-HAZARDOUS WASTE MANIFEST

MANIFEST # 12152

GENERATOR INFORMATION

Generator Name: Tronox LLC

Address: P.O. Box 55

City: Henderson County: Clark

State: NV Zip: 89009

Site Location (if different): 560 W. Lake Mead
Henderson, NV 89015 (702) 592-7727

CUSTOMER/BILLING INFORMATION

Billing Name: NGE LLC c/o Northgate Environment Management

Address: 300 Frank Ogawa Plaza, Ste 510

City: Oakland County: Alameda

State: CA Zip: 94612

Table with 5 columns: Republic Services Approval #, Description of Waste, Volume/Weight, Expiration Date, Container Type. Row 1: 38251011244, Soil for disposal, 35.18 yd, 12-31-2011, Tractor with Dump Trailer(s).

*Attach Additional Sheet if necessary

I hereby certify that the above-described materials are non-hazardous wastes as defined by 40 CFR 261 or any applicable state law. Further, that the above named materials are properly classified, described, packaged, marked and labeled, and are in proper condition for transportation according to the applicable regulations of the Department of Transportation.

Susan Crowley (Signature)
Generator/Authorized Agent Name Signature Date Shipped

TRANSPORTER INFORMATION

Transporter Name: Las Vegas Paving

DOT # 191949

Address: 4420 S. Decatur

Truck Number: 125

Las Vegas, NV 89103

Phone Number: (702) 353-4355

I certify no hazardous waste or other regulated substance was knowingly introduced to the waste while in my custody. The waste transported in this vehicle is the waste identified above, to the best of my knowledge.

Calvin Paguyo (Signature)
Name of Authorized Agent Signature Date Delivered 10-07-10

DISPOSAL SITE INFORMATION

Site Name: Apex Regional Landfill

Phone No. (702) 599-5920

Address: 13550 U.S. Hwy 93 Las Vegas, NV

I hereby acknowledge receipt of the above described materials

Jesse Smith (Signature)
Name (Print or Type) Signature Date Received 10-8-10

81 Environmental Tech
13550 N Highway 93
Las Vegas, NV 89165

Ticket Type: INBOUND INVOICE

Ticket Number: 2064
Date: 10/08/2010
Time In: 2:33 am
Time Out: 2:59 am

Customer: 001011 - NGE, LLC c/o Northgate Environ Mgmt

Vehicle/Container: 76811P
Contract: Northgate Env. On Site Soils 3825 11
Comment: 3825 10 11244

Gross Weight: 119,200 LB Manual In
Tare Weight: 52,480 LB Manual Out
Net Weight: 66,720 LB
Net Tons: 33.36

BOL: 12153

Origin	Yards	Material	Billing	Quantity
Not Applicable	0.00 YD	SW CONTAMINATED SOIL	33.36	TN

Driver:

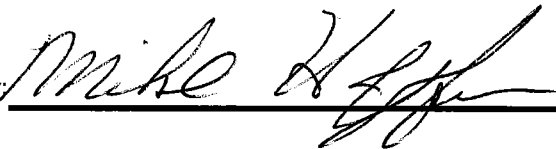

Weighmaster:

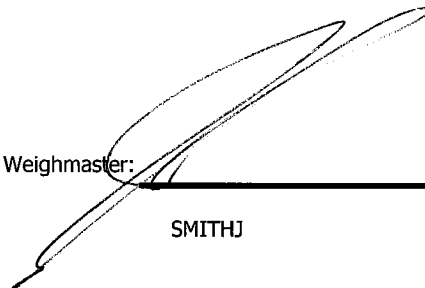

SMITHJ

Indemnification. Customer agrees, by signature above, to indemnify, hold harmless, and defend Republic Services, Inc., its subsidiaries, affiliates, employees, officers and directors from and against any and all liabilities, claims, penalties, forfeitures, suits and the costs and expenses incident thereto, including costs of defense, settlement, and reasonable attorney's fees, which may be incurred, as a result of death or injuries to any person, or damage to any property, contamination of or adverse effects on the environment, caused in whole or in part by the Customer, its employees, or subcontractors in disposing waste at this Facility. In the event Customer delivers Unacceptable Waste (as determined by Republic) Customer agrees to assume all expenses and obligations with the removal and/or resolution of any effects caused by the delivery of such Unacceptable Waste.

Indemnización. Cliente acuerda indemnizar, mantener inmune, y defender Republic Services, Inc., sus subsidiarios, compañías, divisiones, empleados, oficiales y directores contra de cualquiera y de todas responsabilidades, demandas, penas, pérdidas, juicios, pleitos y los costos incidente además, incluyendo costos de defensa, de acuerdo judicial, y de honorarios razonables del abogado, que pueden ser incurridos en, o como resultado de, la muerte o herida personal a cualquier persona, o daños a cualquier característica, propiedad, contaminación de la tierra o efectos ilícitos en esta Facilidad, causado entero o en parte por el cliente, sus empleados, o sus subcontratistas en botar basura en esta Facilidad. En el caso que el Cliente entrega, bota, basura (según lo determinado por Republic) en este Establecimiento basura inaceptable en los reglamentos de este Establecimiento, el Cliente se compromete asumir todos los costos y obligaciones con el retiro y/o la resolución de cualquier dano(s) causado por la entrega de tal basura inaceptable.



NON-HAZARDOUS WASTE MANIFEST

MANIFEST # 12153

GENERATOR INFORMATION

Generator Name: Tronox LLC

Address: P.O. Box 55

City: Henderson County: Clark

State: NV Zip: 89009

Site Location (if different): 560 W. Lake Mead

Henderson, NV 89015 (702) 592-7727

CUSTOMER/BILLING INFORMATION

Billing Name: NGE LLC c/o Northgate Environment Management

Address: 300 Frank Ogawa Plaza, Ste 510

City: Oakland County: Alameda

State: CA Zip: 94612

Republic Services Approval #	Description of Waste	Volume/Weight	Expiration Date	Container Type
38251011244	Soil for disposal		12-31-2011	Tractor with Dump Trailer(s)
	RZ- #	83.36 TL		

*Attach Additional Sheet if necessary

I hereby certify that the above-described materials are non-hazardous wastes as defined by 40 CFR 261 or any applicable state law. Further, that the above named materials are properly classified, described, packaged, marked and labeled, and are in proper condition for transportation according to the applicable regulations of the Department of Transportation.

Susan Crowley
Generator/Authorized Agent Name
Signature
Date Shipped

TRANSPORTER INFORMATION

Transporter Name: Las Vegas Paving

DOT # 191949

Address: 4420 S. Decatur

Truck Number: 272

Las Vegas, NV 89103

Phone Number: (702) 353-4355

I certify no hazardous waste or other regulated substance was knowingly introduced to the waste while in my custody. The waste transported in this vehicle is the waste identified above, to the best of my knowledge.

Mike Heffern
Name of Authorized Agent
Signature
Date Delivered

DISPOSAL SITE INFORMATION

Site Name: Apex Regional Landfill

Phone No. (702) 599-5920

Address: 13550 U.S. Hwy 93 Las Vegas, NV

I hereby acknowledge receipt of the above described materials
Name (Print or Type)
Signature
Date Received

81 Environmental Tech
13550 N Highway 93
Las Vegas, NV 89165

Ticket Type: INBOUND INVOICE

Ticket Number: 2065
Date: 10/08/2010
Time In: 2:43 am
Time Out: 3:04 am

Customer: 001011 - NGE, LLC c/o Northgate Environ Mgmt

Vehicle/Container: 68263P
Contract: Northgate Env. On Site Soils 3825 11
Comment: 3825 10 11244

Gross Weight: 125,380 LB Manual In
Tare Weight: 57,160 LB Manual Out
Net Weight: 68220 LB
Net Tons: 34.11

BOL: 12155

Origin	Yards	Material	Billing	Quantity
Not Applicable	0.00 YD	SW CONTAMINATED SOIL	34.11	TN

Driver: _____

Weighmaster: _____

SMITHJ

Indemnification. Customer agrees, by signature above, to indemnify, hold harmless, and defend Republic Services, Inc., its subsidiaries, affiliates, employees, officers and directors from and against any and all liabilities, claims, penalties, forfeitures, suits and the costs and expenses incident thereto, including costs of defense, settlement, and reasonable attorney's fees, which may be incurred, as a result of death or injuries to any person, or damage to any property, contamination of or adverse effects on the environment, caused in whole or in part by the Customer, its employees, or subcontractors in disposing waste at this Facility. In the event Customer delivers Unacceptable Waste (as determined by Republic) Customer agrees to assume all expenses and obligations with the removal and/or resolution of any effects caused by the delivery of such Unacceptable Waste.

Indemnización. Cliente acuerda indemnizar, mantener inmune, y defender Republic Services, Inc., sus subsidiarios, compañías, divisiones, empleados, oficiales y directores contra de cualquiera y de todas responsabilidades, demandas, penas, pérdidas, juicios, pleitos y los costos incidente además, incluyendo costos de defensa, de acuerdo judicial, y de honorarios razonables del abogado, que pueden ser incurridos en, o como resultado de, la muerte o herida personal a cualquier persona, o daños a cualquier característica, propiedad, contaminación de la tierra o efectos ilícitos en esta Facilidad, causado entero o en parte por el cliente, sus empleados, o sus subcontratistas en botar basura en esta Facilidad. En el caso que el Cliente entrega, bota, basura (según lo determinado por Republic) en este Establecimiento basura inaceptable en los reglamentos de este Establecimiento, el Cliente se compromete asumir todos los costos y obligaciones con el retiro y/o la resolución de cualquier dano(s) causado por la entrega de tal basura inaceptable.



NON-HAZARDOUS WASTE MANIFEST

MANIFEST # 12155

GENERATOR INFORMATION

Generator Name: Tronox LLC

Address: P.O. Box 55

City: Henderson County: Clark

State: NV Zip: 89009

Site Location (if different): 560 W. Lake Mead

Henderson, NV 89015 (702) 592-7727

CUSTOMER/BILLING INFORMATION

Billing Name: NGE LLC c/o Northgate Environment Management

Address: 300 Frank Ogawa Plaza, Ste 510

City: Oakland County: Alameda

State: CA Zip: 94612

Republic Services Approval #	Description of Waste	Volume/Weight	Expiration Date	Container Type
38251011244	Soil for disposal		12-31-2011	Tractor with Dump Trailer(s)
	RZ- _____ # _____	34.11 710		

*Attach Additional Sheet if necessary

I hereby certify that the above-described materials are non-hazardous wastes as defined by 40 CFR 261 or any applicable state law. Further, that the above named materials are properly classified, described, packaged, marked and labeled, and are in proper condition for transportation according to the applicable regulations of the Department of Transportation.

Susan Crowley (Signature) Generator/Authorized Agent Name Date Shipped

TRANSPORTER INFORMATION

Transporter Name: Las Vegas Paving

DOT # 191949

Address: 4420 S. Decatur

Truck Number: 071

Las Vegas, NV 89103

Phone Number: (702) 353-4355

I certify no hazardous waste or other regulated substance was knowingly introduced to the waste while in my custody. The waste transported in this vehicle is the waste identified above, to the best of my knowledge.

Ned M (Signature) Name of Authorized Agent Signature Date Delivered 10-8-10

DISPOSAL SITE INFORMATION

Site Name: Apex Regional Landfill

Phone No. (702) 599-5920

Address: 13550 U.S. Hwy 93 Las Vegas, NV

I hereby acknowledge receipt of the above described materials (Signature) Name (Print or Type) Signature Date Received 10-9-10

81 Environmental Tech
13550 N Highway 93
Las Vegas, NV 89165

Ticket Type: INBOUND INVOICE

Ticket Number: 2066
Date: 10/08/2010
Time In: 2:43 am
Time Out: 3:06 am

Customer: 001011 - NGE, LLC c/o Northgate Environ Mgmt

Vehicle/Container: 76810P
Contract: Northgate Env. On Site Soils 3825 11
Comment: 3825 10 11244

Gross Weight: 122,440 LB Manual In
Tare Weight: 54,960 LB Manual Out
Net Weight: 67480 LB
Net Tons: 33.74

BOL: 12151

Origin	Yards	Material	Billing	Quantity
Not Applicable	0.00 YD	SW CONTAMINATED SOIL	33.74	TN

Driver:

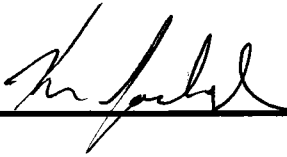

Weighmaster:

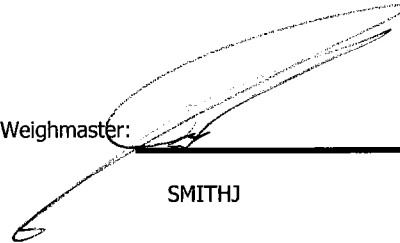

SMITHJ

Indemnification. Customer agrees, by signature above, to indemnify, hold harmless, and defend Republic Services, Inc., its subsidiaries, affiliates, employees, officers and directors from and against any and all liabilities, claims, penalties, forfeitures, suits and the costs and expenses incident thereto, including costs of defense, settlement, and reasonable attorney's fees, which may be incurred, as a result of death or injuries to any person, or damage to any property, contamination of or adverse effects on the environment, caused in whole or in part by the Customer, its employees, or subcontractors in disposing waste at this Facility. In the event Customer delivers Unacceptable Waste (as determined by Republic) Customer agrees to assume all expenses and obligations with the removal and/or resolution of any effects caused by the delivery of such Unacceptable Waste.

Indemnización. Cliente acuerda indemnizar, mantener inmune, y defender Republic Services, Inc., sus subsidiarios, compañías, divisiones, empleados, oficiales y directores contra de cualquiera y de todas responsabilidades, demandas, penas, pérdidas, juicios, pleitos y los costos incidente además, incluyendo costos de defensa, de acuerdo judicial, y de honorarios razonables del abogado, que pueden ser incurridos en, o como resultado de, la muerte o herida personal a cualquier persona, o daños a cualquier característica, propiedad, contaminación de la tierra o efectos ilícitos en esta Facilidad, causado entero o en parte por el cliente, sus empleados, o sus subcontratistas en botar basura en esta Facilidad. En el caso que el Cliente entrega, bota, basura (según lo determinado por Republic) en este Establecimiento basura inaceptable en los reglamentos de este Establecimiento, el Cliente se compromete asumir todos los costos y obligaciones con el retiro y/o la resolución de cualquier dano(s) causado por la entrega de tal basura inaceptable.



NON-HAZARDOUS WASTE MANIFEST

MANIFEST # 12151

GENERATOR INFORMATION

Generator Name: Tronox LLC

Address: P.O. Box 55

City: Henderson County: Clark

State: NV Zip: 89009

Site Location (if different): 560 W. Lake Mead

Henderson, NV 89015 (702) 592-7727

CUSTOMER/BILLING INFORMATION

Billing Name: NGE LLC c/o Northgate Environment Management

Address: 300 Frank Ogawa Plaza, Ste 510

City: Oakland County: Alameda

State: CA Zip: 94612

Republic Services Approval #	Description of Waste	Volume/Weight	Expiration Date	Container Type
38251011244	Soil for disposal		12-31-2011	Tractor with Dump Trailer(s)
	RZ- #	33.7470		

*Attach Additional Sheet if necessary

I hereby certify that the above-described materials are non-hazardous wastes as defined by 40 CFR 261 or any applicable state law. Further, that the above named materials are properly classified, described, packaged, marked and labeled, and are in proper condition for transportation according to the applicable regulations of the Department of Transportation.

Susan Crowley Generator/Authorized Agent Name Signature Date Shipped

TRANSPORTER INFORMATION

Transporter Name: Las Vegas Paving

DOT # 191949

Address: 4420 S. Decatur

Truck Number: 241

Las Vegas, NV 89103

Phone Number: (702) 353-4355

I certify no hazardous waste or other regulated substance was knowingly introduced to the waste while in my custody. The waste transported in this vehicle is the waste identified above, to the best of my knowledge.

Name of Authorized Agent Signature Date Delivered 10-7-2010

DISPOSAL SITE INFORMATION

Site Name: Apex Regional Landfill

Phone No. (702) 599-5920

Address: 13550 U.S. Hwy 93 Las Vegas, NV

I hereby acknowledge receipt of the above described materials

Name (Print or Type) Signature Date Received

81 Environmental Tech
13550 N Highway 93
Las Vegas, NV 89165

Ticket Type: INBOUND INVOICE

Ticket Number: 2067
Date: 10/08/2010
Time In: 2:57 am
Time Out: 3:21 am

Customer: 001011 - NGE, LLC c/o Northgate Environ Mgmt

Vehicle/Container: 68263P
Contract: Northgate Env. On Site Soils 3825 11
Comment: 3825 10 11244

Gross Weight: 127,480 LB Manual In
Tare Weight: 53,860 LB Manual Out
Net Weight: 73620 LB
Net Tons: 36.81

BOL: 12154

Origin	Yards	Material	Billing Quantity
Not Applicable	0.00 YD	SW CONTAMINATED SOIL	36.81 TN

Driver: _____

Weighmaster: _____

SMITHJ

Indemnification. Customer agrees, by signature above, to indemnify, hold harmless, and defend Republic Services, Inc., its subsidiaries, affiliates, employees, officers and directors from and against any and all liabilities, claims, penalties, forfeitures, suits and the costs and expenses incident thereto, including costs of defense, settlement, and reasonable attorney's fees, which may be incurred, as a result of death or injuries to any person, or damage to any property, contamination of or adverse effects on the environment, caused in whole or in part by the Customer, its employees, or subcontractors in disposing waste at this Facility. In the event Customer delivers Unacceptable Waste (as determined by Republic) Customer agrees to assume all expenses and obligations with the removal and/or resolution of any effects caused by the delivery of such Unacceptable Waste.

Indemnización. Cliente acuerda indemnizar, mantener inmune, y defender Republic Services, Inc., sus subsidiarios, compañías, divisiones, empleados, oficiales y directores contra de cualquiera y de todas responsabilidades, demandas, penas, pérdidas, juicios, pleitos y los costos incidente además, incluyendo costos de defensa, de acuerdo judicial, y de honorarios razonables del abogado, que pueden ser incurridos en, o como resultado de, la muerte o herida personal a cualquier persona, o daños a cualquier característica, propiedad, contaminación de la tierra o efectos ilícitos en esta Facilidad, causado entero o en parte por el cliente, sus empleados, o sus subcontratistas en botar basura en esta Facilidad. En el caso que el Cliente entrega, bota, basura (según lo determinado por Republic) en este Establecimiento basura inaceptable en los reglamentos de este Establecimiento, el Cliente se compromete asumir todos los costos y obligaciones con el retiro y/o la resolución de cualquier dano(s) causado por la entrega de tal basura inaceptable.



NON-HAZARDOUS WASTE MANIFEST

MANIFEST # 12154

GENERATOR INFORMATION

Generator Name: Tronox LLC

Address: P.O. Box 55

City: Henderson County: Clark

State: NV Zip: 89009

Site Location (if different): 560 W. Lake Mead

Henderson, NV 89015 (702) 592-7727

CUSTOMER/BILLING INFORMATION

Billing Name: NGE LLC c/o Northgate Environment Management

Address: 300 Frank Ogawa Plaza, Ste 510

City: Oakland County: Alameda

State: CA Zip: 94612

Republic Services Approval #	Description of Waste	Volume/Weight	Expiration Date	Container Type
38251011244	Soil for disposal		12-31-2011	Tractor with Dump Trailer(s)
	RZ- #	3.81 TU		

*Attach Additional Sheet if necessary

I hereby certify that the above-described materials are non-hazardous wastes as defined by 40 CFR 261 or any applicable state law. Further, that the above named materials are properly classified, described, packaged, marked and labeled, and are in proper condition for transportation according to the applicable regulations of the Department of Transportation.

Susan Crowley

Signature: Susan Crowley

Generator/Authorized Agent Name

Signature

Date Shipped

TRANSPORTER INFORMATION

Transporter Name: Las Vegas Paving

DOT # 191949

Address: 4420 S. Decatur

Truck Number: 2711

Las Vegas, NV 89103

Phone Number: (702) 353-4355

I certify no hazardous waste or other regulated substance was knowingly introduced to the waste while in my custody. The waste transported in this vehicle is the waste identified above, to the best of my knowledge.

STEVE WAYES

Signature: Steve Wayes

Name of Authorized Agent

Signature

10-7-10

Date Delivered

DISPOSAL SITE INFORMATION

Site Name: Apex Regional Landfill

Phone No. (702) 599-5920

Address: 13550 U.S. Hwy 93 Las Vegas, NV

I hereby acknowledge receipt of the above described materials

Jesse Smith

Signature: Jesse Smith

Name (Print or Type)

Signature

10-7-10

Date Received

81 Environmental Tech
13550 N Highway 93
Las Vegas, NV 89165

Ticket Type: INBOUND INVOICE

Ticket Number: 2068
Date: 10/08/2010
Time In: 3:15 am
Time Out: 3:36 am

Customer: 001011 - NGE, LLC c/o Northgate Environ Mgmt

Vehicle/Container: 44165A
Contract: Northgate Env. On Site Soils 3825 11
Comment: 001

3825-10-11244

Gross Weight: 118,980 LB Manual In
Tare Weight: 49,000 LB Manual Out
Net Weight: 69,980 LB
Net Tons: 34.99

BOL: 12156

Origin	Yards	Material	Billing	Quantity
Not Applicable	0.00 YD	SW CONTAMINATED SOIL	34.99	TN

Driver:



Weighmaster:

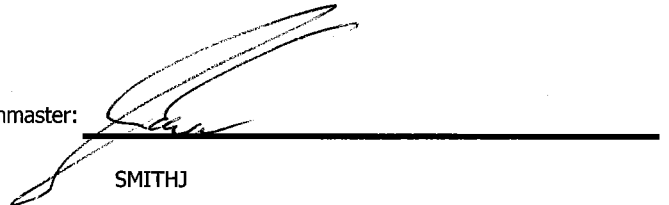

SMITHJ

Indemnification. Customer agrees, by signature above, to indemnify, hold harmless, and defend Republic Services, Inc., its subsidiaries, affiliates, employees, officers and directors from and against any and all liabilities, claims, penalties, forfeitures, suits and the costs and expenses incident thereto, including costs of defense, settlement, and reasonable attorney's fees, which may be incurred, as a result of death or injuries to any person, or damage to any property, contamination of or adverse effects on the environment, caused in whole or in part by the Customer, its employees, or subcontractors in disposing waste at this Facility. In the event Customer delivers Unacceptable Waste (as determined by Republic) Customer agrees to assume all expenses and obligations with the removal and/or resolution of any effects caused by the delivery of such Unacceptable Waste.

Indemnización. Cliente acuerda indemnizar, mantener inmune, y defender Republic Services, Inc., sus subsidiarios, compañías, divisiones, empleados, oficiales y directores contra de cualquiera y de todas responsabilidades, demandas, penas, pérdidas, juicios, pleitos y los costos incidente además, incluyendo costos de defensa, de acuerdo judicial, y de honorarios razonables del abogado, que pueden ser incurridos en, o como resultado de, la muerte o herida personal a cualquier persona, o daños a cualquier característica, propiedad, contaminación de la tierra o efectos ilícitos en esta Facilidad, causado entero o en parte por el cliente, sus empleados, o sus subcontratistas en botar basura en esta Facilidad. En el caso que el Cliente entrega, bota, basura (según lo determinado por Republic) en este Establecimiento basura inaceptable en los reglamentos de este Establecimiento, el Cliente se compromete asumir todos los costos y obligaciones con el retiro y/o la resolución de cualquier dano(s) causado por la entrega de tal basura inaceptable.



NON-HAZARDOUS WASTE MANIFEST

MANIFEST # 12156

GENERATOR INFORMATION

Generator Name: Tronox LLC
Address: P.O. Box 55
City: Henderson County: Clark
State: NV Zip: 89009
Site Location (if different): 560 W. Lake Mead
Henderson, NV 89015 (702) 592-7727

CUSTOMER/BILLING INFORMATION

Billing Name: NGE LLC c/o Northgate Environment Management
Address: 300 Frank Ogawa Plaza, Ste 510
City: Oakland County: Alameda
State: CA Zip: 94612

Table with 5 columns: Republic Services Approval #, Description of Waste, Volume/Weight, Expiration Date, Container Type. Row 1: 38251011244, Soil for disposal, 34.79 lb, 12-31-2011, Tractor with Dump Trailer(s).

*Attach Additional Sheet if necessary

I hereby certify that the above-described materials are non-hazardous wastes as defined by 40 CFR 261 or any applicable state law. Further, that the above named materials are properly classified, described, packaged, marked and labeled, and are in proper condition for transportation according to the applicable regulations of the Department of Transportation.

Susan Crowley (Signature)
Generator/Authorized Agent Name Signature Date Shipped

TRANSPORTER INFORMATION

Transporter Name: Las Vegas Paving DOT # 191949
Address: 4420 S. Decatur Truck Number: K001
Las Vegas, NV 89103 Phone Number: (702) 353-4355

I certify no hazardous waste or other regulated substance was knowingly introduced to the waste while in my custody. The waste transported in this vehicle is the waste identified above, to the best of my knowledge.

Ramon (Signature)
Name of Authorized Agent Signature Date Delivered 10-7-10

DISPOSAL SITE INFORMATION

Site Name: Apex Regional Landfill Phone No. (702) 599-5920
Address: 13550 U.S. Hwy 93 Las Vegas, NV

I hereby acknowledge receipt of the above described materials

Isaac Smith (Signature)
Name (Print or Type) Signature Date Received 8-5-10

81 Environmental Tech
13550 N Highway 93
Las Vegas, NV 89165

Ticket Type: INBOUND INVOICE

Ticket Number: 2069
Date: 10/08/2010
Time In: 3:39 am
Time Out: 4:03 am

Customer: 001011 - NGE, LLC c/o Northgate Environ Mgmt

Vehicle/Container: 44564A
Contract: Northgate Env. On Site Soils 3825 11
Comment: 3825 10 11244

Gross Weight: 130,820 LB Manual In
Tare Weight: 49,120 LB Manual Out
Net Weight: 81700 LB
Net Tons: 40.85

BOL: 12158

Origin	Yards	Material	Billing	Quantity
Not Applicable	0.00 YD	SW CONTAMINATED SOIL	40.85	TN

Driver: _____

CERU

Weighmaster: _____

[Signature]
SMITHJ

Indemnification. Customer agrees, by signature above, to indemnify, hold harmless, and defend Republic Services, Inc., its subsidiaries, affiliates, employees, officers and directors from and against any and all liabilities, claims, penalties, forfeitures, suits and the costs and expenses incident thereto, including costs of defense, settlement, and reasonable attorney's fees, which may be incurred, as a result of death or injuries to any person, or damage to any property, contamination of or adverse effects on the environment, caused in whole or in part by the Customer, its employees, or subcontractors in disposing waste at this Facility. In the event Customer delivers Unacceptable Waste (as determined by Republic) Customer agrees to assume all expenses and obligations with the removal and/or resolution of any effects caused by the delivery of such Unacceptable Waste.

Indemnización. Cliente acuerda indemnizar, mantener inmune, y defender Republic Services, Inc., sus subsidiarios, compañías, divisiones, empleados, oficiales y directores contra de cualquiera y de todas responsabilidades, demandas, penas, pérdidas, juicios, pleitos y los costos incidente además, incluyendo costos de defensa, de acuerdo judicial, y de honorarios razonables del abogado, que pueden ser incurridos en, o como resultado de, la muerte o herida personal a cualquier persona, o daños a cualquier característica, propiedad, contaminación de la tierra o efectos ilícitos en esta Facilidad, causado entero o en parte por el cliente, sus empleados, o sus subcontratistas en botar basura en esta Facilidad. En el caso que el Cliente entrega, bota, basura (según lo determinado por Republic) en este Establecimiento basura inaceptable en los reglamentos de este Establecimiento, el Cliente se compromete asumir todos los costos y obligaciones con el retiro y/o la resolución de cualquier dano(s) causado por la entrega de tal basura inaceptable.



NON-HAZARDOUS WASTE MANIFEST

MANIFEST # 12158

GENERATOR INFORMATION

Generator Name: Tronox LLCAddress: P.O. Box 55City: Henderson County: ClarkState: NV Zip: 89009Site Location (if different): 560 W. Lake MeadHenderson, NV 89015 (702) 592-7727

CUSTOMER/BILLING INFORMATION

Billing Name: NGE LLC c/o Northgate Environment ManagementAddress: 300 Frank Ogawa Plaza, Ste 510City: Oakland County: AlamedaState: CA Zip: 94612

Republic Services Approval #	Description of Waste	Volume/Weight	Expiration Date	Container Type
38251011244	Soil for disposal		12-31-2011	Tractor with Dump Trailer(s)
	RZ- _____ # _____	40.85 TN		

*Attach Additional Sheet if necessary

I hereby certify that the above-described materials are non-hazardous wastes as defined by 40 CFR 261 or any applicable state law. Further, that the above named materials are properly classified, described, packaged, marked and labeled, and are in proper condition for transportation according to the applicable regulations of the Department of Transportation.

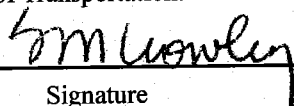
Susan Crowley 
 Generator/Authorized Agent Name Signature Date Shipped

TRANSPORTER INFORMATION

Transporter Name: Las Vegas PavingDOT # 191949Address: 4420 S. DecaturTruck Number: K003Las Vegas, NV 89103Phone Number: (702) 353-4355

I certify no hazardous waste or other regulated substance was knowingly introduced to the waste while in my custody. The waste transported in this vehicle is the waste identified above, to the best of my knowledge.

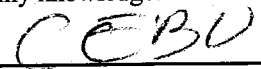
CEBU  10/07/10
 Name of Authorized Agent Signature Date Delivered

DISPOSAL SITE INFORMATION

Site Name: Apex Regional LandfillPhone No. (702) 599-5920Address: 13550 U.S. Hwy 93 Las Vegas, NV

I hereby acknowledge receipt of the above described materials

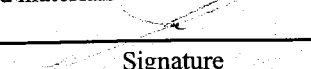
Joe [Signature]  10/8/10
 Name (Print or Type) Signature Date Received

81 Environmental Tech
13550 N Highway 93
Las Vegas, NV 89165

Ticket Type: INBOUND INVOICE

Ticket Number: 2070
Date: 10/08/2010
Time In: 3:40 am
Time Out: 4:04 am

Customer: 001011 - NGE, LLC c/o Northgate Environ Mgmt

Vehicle/Container: 86113P
Contract: Northgate Env. On Site Soils 3825 11
Comment: 3825 10 11244

Gross Weight: 137,240 LB Manual In
Tare Weight: 55,160 LB Manual Out
Net Weight: 82080 LB
Net Tons: 41.04

BOL: 12159

Origin	Yards	Material	Billing Quantity
Not Applicable	0.00 YD	SW CONTAMINATED SOIL	41.04 TN

Driver: _____

J. A. H.

Weighmaster: _____

SMITHJ

Indemnification. Customer agrees, by signature above, to indemnify, hold harmless, and defend Republic Services, Inc., its subsidiaries, affiliates, employees, officers and directors from and against any and all liabilities, claims, penalties, forfeitures, suits and the costs and expenses incident thereto, including costs of defense, settlement, and reasonable attorney's fees, which may be incurred, as a result of death or injuries to any person, or damage to any property, contamination of or adverse effects on the environment, caused in whole or in part by the Customer, its employees, or subcontractors in disposing waste at this Facility. In the event Customer delivers Unacceptable Waste (as determined by Republic) Customer agrees to assume all expenses and obligations with the removal and/or resolution of any effects caused by the delivery of such Unacceptable Waste.

Indemnización. Cliente acuerda indemnizar, mantener inmune, y defender Republic Services, Inc., sus subsidiarios, compañías, divisiones, empleados, oficiales y directores contra de cualquiera y de todas responsabilidades, demandas, penas, pérdidas, juicios, pleitos y los costos incidente además, incluyendo costos de defensa, de acuerdo judicial, y de honorarios razonables del abogado, que pueden ser incurridos en, o como resultado de, la muerte o herida personal a cualquier persona, o daños a cualquier característica, propiedad, contaminación de la tierra o efectos ilícitos en esta Facilidad, causado entero o en parte por el cliente, sus empleados, o sus subcontratistas en botar basura en esta Facilidad. En el caso que el Cliente entrega, bota, basura (según lo determinado por Republic) en este Establecimiento basura inaceptable en los reglamentos de este Establecimiento, el Cliente se compromete asumir todos los costos y obligaciones con el retiro y/o la resolución de cualquier dano(s) causado por la entrega de tal basura inaceptable.



NON-HAZARDOUS WASTE MANIFEST

MANIFEST # 12159

GENERATOR INFORMATION

Generator Name: Tronox LLC

Address: P.O. Box 55

City: Henderson County: Clark

State: NV Zip: 89009

Site Location (if different): 560 W. Lake Mead

Henderson, NV 89015 (702) 592-7727

CUSTOMER/BILLING INFORMATION

Billing Name: NGE LLC c/o Northgate Environment Management

Address: 300 Frank Ogawa Plaza, Ste 510

City: Oakland County: Alameda

State: CA Zip: 94612

Republic Services Approval #	Description of Waste	Volume/Weight	Expiration Date	Container Type
38251011244	Soil for disposal		12-31-2011	Tractor with Dump Trailer(s)
	RZ- _____ # _____	41.04 TON		

*Attach Additional Sheet if necessary

I hereby certify that the above-described materials are non-hazardous wastes as defined by 40 CFR 261 or any applicable state law. Further, that the above named materials are properly classified, described, packaged, marked and labeled, and are in proper condition for transportation according to the applicable regulations of the Department of Transportation.

Susan Crowley (Signature) Generator/Authorized Agent Name Signature Date Shipped

TRANSPORTER INFORMATION

Transporter Name: Las Vegas Paving

DOT # 191949

Address: 4420 S. Decatur

Truck Number: K0019/M

Las Vegas, NV 89103

Phone Number: (702) 353-4355

I certify no hazardous waste or other regulated substance was knowingly introduced to the waste while in my custody. The waste transported in this vehicle is the waste identified above, to the best of my knowledge.

ALBERTO (Signature) Name of Authorized Agent Signature Date Delivered Oct 7, 2010

DISPOSAL SITE INFORMATION

Site Name: Apex Regional Landfill

Phone No. (702) 599-5920

Address: 13550 U.S. Hwy 93 Las Vegas, NV

I hereby acknowledge receipt of the above described materials

(Signature) Name (Print or Type) Signature Date Received

81 Environmental Tech
13550 N Highway 93
Las Vegas, NV 89165

Ticket Type: INBOUND INVOICE

Ticket Number: 2071
Date: 10/08/2010
Time In: 3:37 am
Time Out: 4:09 am

Customer: 001011 - NGE, LLC c/o Northgate Environ Mgmt

Vehicle/Container: 192456
Contract: Northgate Env. On Site Soils 3825 11
Comment: 3825 10 11244

Gross Weight: 123,840 LB Manual In
Tare Weight: 52,780 LB Manual Out
Net Weight: 71060 LB
Net Tons: 35.53

BOL: 12160

Origin	Yards	Material	Billing	Quantity
Not Applicable	0.00 YD	SW CONTAMINATED SOIL	35.53	TN

Driver: _____

Weighmaster: _____

SMITHJ

Indemnification. Customer agrees, by signature above, to indemnify, hold harmless, and defend Republic Services, Inc., its subsidiaries, affiliates, employees, officers and directors from and against any and all liabilities, claims, penalties, forfeitures, suits and the costs and expenses incident thereto, including costs of defense, settlement, and reasonable attorney's fees, which may be incurred, as a result of death or injuries to any person, or damage to any property, contamination of or adverse effects on the environment, caused in whole or in part by the Customer, its employees, or subcontractors in disposing waste at this Facility. In the event Customer delivers Unacceptable Waste (as determined by Republic) Customer agrees to assume all expenses and obligations with the removal and/or resolution of any effects caused by the delivery of such Unacceptable Waste.

Indemnización. Cliente acuerda indemnizar, mantener inmune, y defender Republic Services, Inc., sus subsidiarios, compañías, divisiones, empleados, oficiales y directores contra de cualquiera y de todas responsabilidades, demandas, penas, pérdidas, juicios, pleitos y los costos incidente además, incluyendo costos de defensa, de acuerdo judicial, y de honorarios razonables del abogado, que pueden ser incurridos en, o como resultado de, la muerte o herida personal a cualquier persona, o daños a cualquier característica, propiedad, contaminación de la tierra o efectos ilícitos en esta Facilidad, causado entero o en parte por el cliente, sus empleados, o sus subcontratistas en botar basura en esta Facilidad. En el caso que el Cliente entrega, bota, basura (según lo determinado por Republic) en este Establecimiento basura inaceptable en los reglamentos de este Establecimiento, el Cliente se compromete asumir todos los costos y obligaciones con el retiro y/o la resolución de cualquier dano(s) causado por la entrega de tal basura inaceptable.



NON-HAZARDOUS WASTE MANIFEST

MANIFEST # 12160

GENERATOR INFORMATION

Generator Name: Tronox LLC
Address: P.O. Box 55
City: Henderson County: Clark
State: NV Zip: 89009
Site Location (if different): 560 W. Lake Mead
Henderson, NV 89015 (702) 592-7727

CUSTOMER/BILLING INFORMATION

Billing Name: NGE LLC c/o Northgate Environment Management
Address: 300 Frank Ogawa Plaza, Ste 510
City: Oakland County: Alameda
State: CA Zip: 94612

Table with 5 columns: Republic Services Approval #, Description of Waste, Volume/Weight, Expiration Date, Container Type. Row 1: 38251011244, Soil for disposal, 35.52 TON, 12-31-2011, Tractor with Dump Trailer(s).

*Attach Additional Sheet if necessary

I hereby certify that the above-described materials are non-hazardous wastes as defined by 40 CFR 261 or any applicable state law. Further, that the above named materials are properly classified, described, packaged, marked and labeled, and are in proper condition for transportation according to the applicable regulations of the Department of Transportation.

Susan Crowley (Name)
[Signature] (Signature)
Date Shipped

TRANSPORTER INFORMATION

Transporter Name: Las Vegas Paving DOT # 191949
Address: 4420 S. Decatur Truck Number: 192456
Las Vegas, NV 89103 Phone Number: (702) 353-4355

I certify no hazardous waste or other regulated substance was knowingly introduced to the waste while in my custody. The waste transported in this vehicle is the waste identified above, to the best of my knowledge.

[Signature] (Name of Authorized Agent)
[Signature] (Signature)
10/7/10 (Date Delivered)

DISPOSAL SITE INFORMATION

Site Name: Apex Regional Landfill Phone No. (702) 599-5920
Address: 13550 U.S. Hwy 93 Las Vegas, NV

I hereby acknowledge receipt of the above described materials

[Signature] (Name (Print or Type))
[Signature] (Signature)
10/8/10 (Date Received)

81 Environmental Tech
13550 N Highway 93
Las Vegas, NV 89165

Ticket Type: INBOUND INVOICE

Ticket Number: 2072
Date: 10/08/2010
Time In: 3:43 am
Time Out: 4:12 am

Customer: 001011 - NGE, LLC c/o Northgate Environ Mgmt

Vehicle/Container: 192460
Contract: Northgate Env. On Site Soils 3825 11
Comment: 3825 10 11244

Gross Weight: 126,480 LB Manual In
Tare Weight: 53,000 LB Manual Out
Net Weight: 73480 LB
Net Tons: 36.74

BOL: 12161

Origin	Yards	Material	Billing Quantity
Not Applicable	0.00 YD	SW CONTAMINATED SOIL	36.74 TN

Driver:



Weighmaster:



SMITHJ

Indemnification. Customer agrees, by signature above, to indemnify, hold harmless, and defend Republic Services, Inc., its subsidiaries, affiliates, employees, officers and directors from and against any and all liabilities, claims, penalties, forfeitures, suits and the costs and expenses incident thereto, including costs of defense, settlement, and reasonable attorney's fees, which may be incurred, as a result of death or injuries to any person, or damage to any property, contamination of or adverse effects on the environment, caused in whole or in part by the Customer, its employees, or subcontractors in disposing waste at this Facility. In the event Customer delivers Unacceptable Waste (as determined by Republic) Customer agrees to assume all expenses and obligations with the removal and/or resolution of any effects caused by the delivery of such Unacceptable Waste.

Indemnización. Cliente acuerda indemnizar, mantener inmune, y defender Republic Services, Inc., sus subsidiarios, compañías, divisiones, empleados, oficiales y directores contra de cualquiera y de todas responsabilidades, demandas, penas, pérdidas, juicios, pleitos y los costos incidente además, incluyendo costos de defensa, de acuerdo judicial, y de honorarios razonables del abogado, que pueden ser incurridos en, o como resultado de, la muerte o herida personal a cualquier persona, o daños a cualquier característica, propiedad, contaminación de la tierra o efectos ilícitos en esta Facilidad, causado entero o en parte por el cliente, sus empleados, o sus subcontratistas en botar basura en esta Facilidad. En el caso que el Cliente entrega, bota, basura (según lo determinado por Republic) en este Establecimiento basura inaceptable en los reglamentos de este Establecimiento, el Cliente se compromete asumir todos los costos y obligaciones con el retiro y/o la resolución de cualquier dano(s) causado por la entrega de tal basura inaceptable.



NON-HAZARDOUS WASTE MANIFEST

MANIFEST # 12161

GENERATOR INFORMATION

Generator Name: Tronox LLC
Address: P.O. Box 55
City: Henderson County: Clark
State: NV Zip: 89009
Site Location (if different): 560 W. Lake Mead
Henderson, NV 89015 (702) 592-7727

CUSTOMER/BILLING INFORMATION

Billing Name: NGE LLC c/o Northgate Environment Management
Address: 300 Frank Ogawa Plaza, Ste 510
City: Oakland County: Alameda
State: CA Zip: 94612

Table with 5 columns: Republic Services Approval #, Description of Waste, Volume/Weight, Expiration Date, Container Type. Row 1: 38251011244, Soil for disposal, 26.78 m, 12-31-2011, Tractor with Dump Trailer(s).

*Attach Additional Sheet if necessary

I hereby certify that the above-described materials are non-hazardous wastes as defined by 40 CFR 261 or any applicable state law. Further, that the above named materials are properly classified, described, packaged, marked and labeled, and are in proper condition for transportation according to the applicable regulations of the Department of Transportation.

Susan Crowley
Generator/Authorized Agent Name Signature Date Shipped

TRANSPORTER INFORMATION

Transporter Name: Las Vegas Paving DOT # 191949
Address: 4420 S. Decatur Truck Number: 2460
Las Vegas, NV 89103 Phone Number: (702) 353-4355

I certify no hazardous waste or other regulated substance was knowingly introduced to the waste while in my custody. The waste transported in this vehicle is the waste identified above, to the best of my knowledge.

Greg Honish
Name of Authorized Agent Signature Date Delivered 10-7-10

DISPOSAL SITE INFORMATION

Site Name: Apex Regional Landfill Phone No. (702) 599-5920
Address: 13550 U.S. Hwy 93 Las Vegas, NV

I hereby acknowledge receipt of the above described materials

Jesse Smith
Name (Print or Type) Signature Date Received 10-8-10

81 Environmental Tech
13550 N Highway 93
Las Vegas, NV 89165

Ticket Type: INBOUND INVOICE

Ticket Number: 2073
Date: 10/08/2010
Time In: 3:47 am
Time Out: 4:14 am

Customer: 001011 - NGE, LLC c/o Northgate Environ Mgmt

Vehicle/Container: 192457
Contract: Northgate Env. On Site Soils 3825 11
Comment: 3825 10 11244

Gross Weight: 125,600 LB Manual In
Tare Weight: 51,560 LB Manual Out
Net Weight: 74040 LB
Net Tons: 37.02

BOL: 12162

Origin	Yards	Material	Billing	Quantity
Not Applicable	0.00 YD	SW CONTAMINATED SOIL	37.02	TN

Driver:

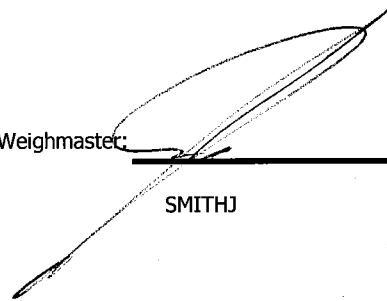

Weighmaster:

SMITHJ

Indemnification. Customer agrees, by signature above, to indemnify, hold harmless, and defend Republic Services, Inc., its subsidiaries, affiliates, employees, officers and directors from and against any and all liabilities, claims, penalties, forfeitures, suits and the costs and expenses incident thereto, including costs of defense, settlement, and reasonable attorney's fees, which may be incurred, as a result of death or injuries to any person, or damage to any property, contamination of or adverse effects on the environment, caused in whole or in part by the Customer, its employees, or subcontractors in disposing waste at this Facility. In the event Customer delivers Unacceptable Waste (as determined by Republic) Customer agrees to assume all expenses and obligations with the removal and/or resolution of any effects caused by the delivery of such Unacceptable Waste.

Indemnización. Cliente acuerda indemnizar, mantener inmune, y defender Republic Services, Inc., sus subsidiarios, compañías, divisiones, empleados, oficiales y directores contra de cualquiera y de todas responsabilidades, demandas, penas, pérdidas, juicios, pleitos y los costos incidente además, incluyendo costos de defensa, de acuerdo judicial, y de honorarios razonables del abogado, que pueden ser incurridos en, o como resultado de, la muerte o herida personal a cualquier persona, o daños a cualquier característica, propiedad, contaminación de la tierra o efectos ilícitos en esta Facilidad, causado entero o en parte por el cliente, sus empleados, o sus subcontratistas en botar basura en esta Facilidad. En el caso que el Cliente entrega, bota, basura (según lo determinado por Republic) en este Establecimiento basura inaceptable en los reglamentos de este Establecimiento, el Cliente se compromete asumir todos los costos y obligaciones con el retiro y/o la resolución de cualquier dano(s) causado por la entrega de tal basura inaceptable.



NON-HAZARDOUS WASTE MANIFEST

MANIFEST # 12162

GENERATOR INFORMATION

Generator Name: Tronox LLC

Address: P.O. Box 55

City: Henderson County: Clark

State: NV Zip: 89009

Site Location (if different): 560 W. Lake Mead

Henderson, NV 89015 (702) 592-7727

CUSTOMER/BILLING INFORMATION

Billing Name: NGE LLC c/o Northgate Environment Management

Address: 300 Frank Ogawa Plaza, Ste 510

City: Oakland County: Alameda

State: CA Zip: 94612

Republic Services Approval #	Description of Waste	Volume/Weight	Expiration Date	Container Type
38251011244	Soil for disposal		12-31-2011	Tractor with Dump Trailer(s)
	RZ- #	32.07 TN		

*Attach Additional Sheet if necessary

I hereby certify that the above-described materials are non-hazardous wastes as defined by 40 CFR 261 or any applicable state law. Further, that the above named materials are properly classified, described, packaged, marked and labeled, and are in proper condition for transportation according to the applicable regulations of the Department of Transportation.

Susan Crowley

Susan Crowley

Generator/Authorized Agent Name

Signature

Date Shipped

TRANSPORTER INFORMATION

Transporter Name: Las Vegas Paving

DOT # 191949

Address: 4420 S. Decatur

Truck Number: 192457

Las Vegas, NV 89103

Phone Number: (702) 353-4355

I certify no hazardous waste or other regulated substance was knowingly introduced to the waste while in my custody. The waste transported in this vehicle is the waste identified above, to the best of my knowledge.

Brian Binkley

BB/14

10-7-10

Name of Authorized Agent

Signature

Date Delivered

DISPOSAL SITE INFORMATION

Site Name: Apex Regional Landfill

Phone No. (702) 599-5920

Address: 13550 U.S. Hwy 93 Las Vegas, NV

I hereby acknowledge receipt of the above described materials

MS Smith

[Signature]

10/8/10

Name (Print or Type)

Signature

Date Received

81 Environmental Tech
13550 N Highway 93
Las Vegas, NV 89165

Ticket Type: INBOUND INVOICE

Ticket Number: 2074
Date: 10/08/2010
Time In: 3:49 am
Time Out: 4:16 am

Customer: 001011 - NGE, LLC c/o Northgate Environ Mgmt

Vehicle/Container: 35903A
Contract: Northgate Env. On Site Soils 3825 11
Comment: 3825 10 11244

Gross Weight: 125,200 LB Manual In
Tare Weight: 57,220 LB Manual Out
Net Weight: 67980 LB
Net Tons: 33.99

BOL: 12164

Origin	Yards	Material	Billing Quantity
Not Applicable	0.00 YD	SW CONTAMINATED SOIL	33.99 TN

Driver:

JAY MASON

Weighmaster:

SMITHJ

Indemnification. Customer agrees, by signature above, to indemnify, hold harmless, and defend Republic Services, Inc., its subsidiaries, affiliates, employees, officers and directors from and against any and all liabilities, claims, penalties, forfeitures, suits and the costs and expenses incident thereto, including costs of defense, settlement, and reasonable attorney's fees, which may be incurred, as a result of death or injuries to any person, or damage to any property, contamination of or adverse effects on the environment, caused in whole or in part by the Customer, its employees, or subcontractors in disposing waste at this Facility. In the event Customer delivers Unacceptable Waste (as determined by Republic) Customer agrees to assume all expenses and obligations with the removal and/or resolution of any effects caused by the delivery of such Unacceptable Waste.

Indemnización. Cliente acuerda indemnizar, mantener inmune, y defender Republic Services, Inc., sus subsidiarios, compañías, divisiones, empleados, oficiales y directores contra de cualquiera y de todas responsabilidades, demandas, penas, pérdidas, juicios, pleitos y los costos incidente además, incluyendo costos de defensa, de acuerdo judicial, y de honorarios razonables del abogado, que pueden ser incurridos en, o como resultado de, la muerte o herida personal a cualquier persona, o daños a cualquier característica, propiedad, contaminación de la tierra o efectos ilícitos en esta Facilidad, causado entero o en parte por el cliente, sus empleados, o sus subcontratistas en botar basura en esta Facilidad. En el caso que el Cliente entrega, bota, basura (según lo determinado por Republic) en este Establecimiento basura inaceptable en los reglamentos de este Establecimiento, el Cliente se compromete asumir todos los costos y obligaciones con el retiro y/o la resolución de cualquier dano(s) causado por la entrega de tal basura inaceptable.



NON-HAZARDOUS WASTE MANIFEST

MANIFEST # 12164

GENERATOR INFORMATION

Generator Name: Tronox LLC

Address: P.O. Box 55

City: Henderson County: Clark

State: NV Zip: 89009

Site Location (if different): 560 W. Lake Mead

Henderson, NV 89015 (702) 592-7727

CUSTOMER/BILLING INFORMATION

Billing Name: NGE LLC c/o Northgate Environment Management

Address: 300 Frank Ogawa Plaza, Ste 510

City: Oakland County: Alameda

State: CA Zip: 94612

Republic Services Approval #	Description of Waste	Volume/Weight	Expiration Date	Container Type
38251011244	Soil for disposal		12-31-2011	Tractor with Dump Trailer(s)
	RZ- #	53.95 10		

*Attach Additional Sheet if necessary

I hereby certify that the above-described materials are non-hazardous wastes as defined by 40 CFR 261 or any applicable state law. Further, that the above named materials are properly classified, described, packaged, marked and labeled, and are in proper condition for transportation according to the applicable regulations of the Department of Transportation.

Susan Crowley

[Signature]

Generator/Authorized Agent Name

Signature

Date Shipped

TRANSPORTER INFORMATION

Transporter Name: Las Vegas Paving

DOT # 191949

Address: 4420 S. Decatur

Truck Number: 04

Las Vegas, NV 89103

Phone Number: (702) 353-4355

I certify no hazardous waste or other regulated substance was knowingly introduced to the waste while in my custody. The waste transported in this vehicle is the waste identified above, to the best of my knowledge.

Weidoo BC

JAY MASON

10-8-10

Name of Authorized Agent

Signature

Date Delivered

DISPOSAL SITE INFORMATION

Site Name: Apex Regional Landfill

Phone No. (702) 599-5920

Address: 13550 U.S. Hwy 93 Las Vegas, NV

I hereby acknowledge receipt of the above described materials

[Signature]

[Signature]

10-8-10

Name (Print or Type)

Signature

Date Received

81 Environmental Tech
13550 N Highway 93
Las Vegas, NV 89165

Ticket Type: INBOUND INVOICE

Ticket Number: 2075
Date: 10/08/2010
Time In: 3:53 am
Time Out: 4:21 am

Customer: 001011 - NGE, LLC c/o Northgate Environ Mgmt

Vehicle/Container: 44166A
Contract: Northgate Env. On Site Soils 3825 11
Comment: 3825 10 11244

Gross Weight: 128,720 LB Manual In
Tare Weight: 56,960 LB Manual Out
Net Weight: 71760 LB
Net Tons: 35.88

BOL: 12163

Origin	Yards	Material	Billing Quantity
Not Applicable	0.00 YD	SW CONTAMINATED SOIL	35.88 TN

Driver: _____



Weighmaster: _____

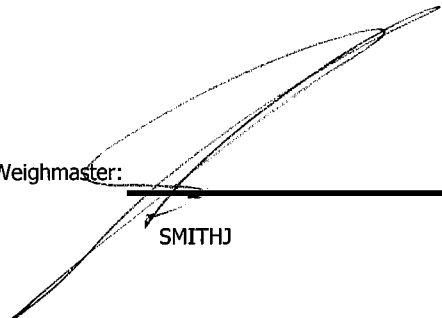

SMITHJ

Indemnification. Customer agrees, by signature above, to indemnify, hold harmless, and defend Republic Services, Inc., its subsidiaries, affiliates, employees, officers and directors from and against any and all liabilities, claims, penalties, forfeitures, suits and the costs and expenses incident thereto, including costs of defense, settlement, and reasonable attorney's fees, which may be incurred, as a result of death or injuries to any person, or damage to any property, contamination of or adverse effects on the environment, caused in whole or in part by the Customer, its employees, or subcontractors in disposing waste at this Facility. In the event Customer delivers Unacceptable Waste (as determined by Republic) Customer agrees to assume all expenses and obligations with the removal and/or resolution of any effects caused by the delivery of such Unacceptable Waste.

Indemnización. Cliente acuerda indemnizar, mantener inmune, y defender Republic Services, Inc., sus subsidiarios, companias, divisiones, empleados, oficiales y directores contra de cualquiera y de todas responsabilidades, demandas, penas, pérdidas, juicios, pleitos y los costos incidente además, incluyendo costos de defensa, de acuerdo judicial, y de honorarios razonables del abogado, que pueden ser incurridos en, o como resultado de, la muerte o herida personal a cualquier persona, o daños a cualquier característica, propiedad, contaminación de la tierra o efectos ilicitos en esta Facilidad, causado entero o en parte por el cliente, sus empleados, o sus subcontratistas en botar basura en esta Facilidad. En el caso que el Cliente entrega, bota, basura (según lo determinado por Republic) en este Establecimiento basura inaceptable en los reglamentos de este Establecimiento, el Cliente se compromete asumir todos los costos y obligaciones con el retiro y/o la resolución de cualquier dano(s) causado por la entrega de tal basura inaceptable.



NON-HAZARDOUS WASTE MANIFEST

MANIFEST # 12163

GENERATOR INFORMATION

Generator Name: Tronox LLC
Address: P.O. Box 55
City: Henderson County: Clark
State: NV Zip: 89009
Site Location (if different): 560 W. Lake Mead
Henderson, NV 89015 (702) 592-7727

CUSTOMER/BILLING INFORMATION

Billing Name: NGE LLC c/o Northgate Environment Management
Address: 300 Frank Ogawa Plaza, Ste 510
City: Oakland County: Alameda
State: CA Zip: 94612

Table with 5 columns: Republic Services Approval #, Description of Waste, Volume/Weight, Expiration Date, Container Type. Row 1: 38251011244, Soil for disposal, 35.88 TW, 12-31-2011, Tractor with Dump Trailer(s).

*Attach Additional Sheet if necessary

I hereby certify that the above-described materials are non-hazardous wastes as defined by 40 CFR 261 or any applicable state law. Further, that the above named materials are properly classified, described, packaged, marked and labeled, and are in proper condition for transportation according to the applicable regulations of the Department of Transportation.

Susan Crowley (Generator/Authorized Agent Name), Tom Crowley (Signature), Date Shipped

TRANSPORTER INFORMATION

Transporter Name: Las Vegas Paving DOT # 191949
Address: 4420 S. Decatur Truck Number: K002
Las Vegas, NV 89103 Phone Number: (702) 353-4355

I certify no hazardous waste or other regulated substance was knowingly introduced to the waste while in my custody. The waste transported in this vehicle is the waste identified above, to the best of my knowledge.

Hugo Castillo (Name of Authorized Agent), Signature, 10-7-10 (Date Delivered)

DISPOSAL SITE INFORMATION

Site Name: Apex Regional Landfill Phone No. (702) 599-5920
Address: 13550 U.S. Hwy 93 Las Vegas, NV

I hereby acknowledge receipt of the above described materials

Jose Sandoval (Name (Print or Type)), Signature, 10-2-10 (Date Received)

81 Environmental Tech
13550 N Highway 93
Las Vegas, NV 89165

Ticket Type: INBOUND INVOICE

Ticket Number: 2076
Date: 10/08/2010
Time In: 4:07 am
Time Out: 4:33 am

Customer: 001011 - NGE, LLC c/o Northgate Environ Mgmt

Vehicle/Container: 81495P
Contract: Northgate Env. On Site Soils 3825 11
Comment: 3825 10 11244

Gross Weight: 120,360 LB Manual In
Tare Weight: 51,440 LB Manual Out
Net Weight: 68920 LB
Net Tons: 34.46

BOL: 12165

Origin	Yards	Material	Billing Quantity
Not Applicable	0.00 YD	SW CONTAMINATED SOIL	34.46 TN

Driver: _____

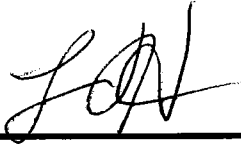

Weighmaster: _____

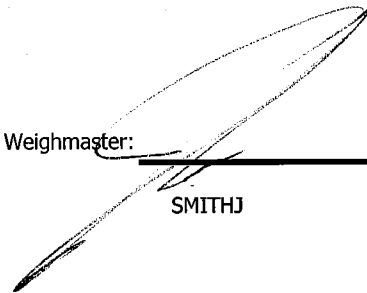

SMITHJ

Indemnification. Customer agrees, by signature above, to indemnify, hold harmless, and defend Republic Services, Inc., its subsidiaries, affiliates, employees, officers and directors from and against any and all liabilities, claims, penalties, forfeitures, suits and the costs and expenses incident thereto, including costs of defense, settlement, and reasonable attorney's fees, which may be incurred, as a result of death or injuries to any person, or damage to any property, contamination of or adverse effects on the environment, caused in whole or in part by the Customer, its employees, or subcontractors in disposing waste at this Facility. In the event Customer delivers Unacceptable Waste (as determined by Republic) Customer agrees to assume all expenses and obligations with the removal and/or resolution of any effects caused by the delivery of such Unacceptable Waste.

Indemnización. Cliente acuerda indemnizar, mantener inmune, y defender Republic Services, Inc., sus subsidiarios, compañías, divisiones, empleados, oficiales y directores contra de cualquiera y de todas responsabilidades, demandas, penas, pérdidas, juicios, pleitos y los costos incidente además, incluyendo costos de defensa, de acuerdo judicial, y de honorarios razonables del abogado, que pueden ser incurridos en, o como resultado de, la muerte o herida personal a cualquier persona, o daños a cualquier característica, propiedad, contaminación de la tierra o efectos ilícitos en esta Facilidad, causado entero o en parte por el cliente, sus empleados, o sus subcontratistas en botar basura en esta Facilidad. En el caso que el Cliente entrega, bota, basura (según lo determinado por Republic) en este Establecimiento basura inaceptable en los reglamentos de este Establecimiento, el Cliente se compromete asumir todos los costos y obligaciones con el retiro y/o la resolución de cualquier dano(s) causado por la entrega de tal basura inaceptable.



SR 40238

NON-HAZARDOUS WASTE MANIFEST

MANIFEST # 12165

GENERATOR INFORMATION

Generator Name: Tronox LLC
 Address: P.O. Box 55
 City: Henderson County: Clark
 State: NV Zip: 89009
 Site Location (if different): 560 W. Lake Mead
Henderson, NV 89015 (702) 592-7727

CUSTOMER/BILLING INFORMATION

Billing Name: NGE LLC c/o Northgate Environment Management
 Address: 300 Frank Ogawa Plaza, Ste 510
 City: Oakland County: Alameda
 State: CA Zip: 94612

Republic Services Approval #	Description of Waste	Volume/Weight	Expiration Date	Container Type
38251011244	Soil for disposal		12-31-2011	Tractor with Dump Trailer(s)
	RZ- _____ # _____	34,4670		

*Attach Additional Sheet if necessary

I hereby certify that the above-described materials are non-hazardous wastes as defined by 40 CFR 261 or any applicable state law. Further, that the above named materials are properly classified, described, packaged, marked and labeled, and are in proper condition for transportation according to the applicable regulations of the Department of Transportation.

Susan Crowley 
 Generator/Authorized Agent Name Signature Date Shipped

TRANSPORTER INFORMATION

Transporter Name: Las Vegas Paving DOT # 191949
 Address: 4420 S. Decatur Truck Number: 175
Las Vegas, NV 89103 Phone Number: (702) 353-4355

I certify no hazardous waste or other regulated substance was knowingly introduced to the waste while in my custody. The waste transported in this vehicle is the waste identified above, to the best of my knowledge.

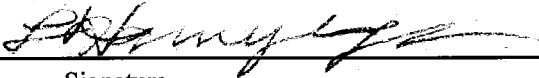
Larry Harshberger 
 Name of Authorized Agent Signature Date Delivered 10-7-10

DISPOSAL SITE INFORMATION

Site Name: Apex Regional Landfill Phone No. (702) 599-5920
 Address: 13550 U.S. Hwy 93 Las Vegas, NV

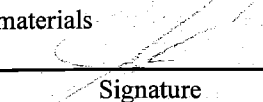
I hereby acknowledge receipt of the above described materials.
John Smith 
 Name (Print or Type) Signature Date Received 10-8-10

81 Environmental Tech
13550 N Highway 93
Las Vegas, NV 89165

Ticket Type: INBOUND INVOICE

Ticket Number: 2077
Date: 10/08/2010
Time In: 4:19 am
Time Out: 4:45 am

Customer: 001011 - NGE, LLC c/o Northgate Environ Mgmt

Vehicle/Container: 81496P
Contract: Northgate Env. On Site Soils 3825 11
Comment: 3825 10 11244

Gross Weight: 120,700 LB Manual In
Tare Weight: 50,660 LB Manual Out
Net Weight: 70040 LB
Net Tons: 35.02

BOL: 12166

Origin	Yards	Material	Billing Quantity
Not Applicable	0.00 YD	SW CONTAMINATED SOIL	35.02 TN

Driver:

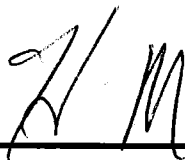

Weighmaster:

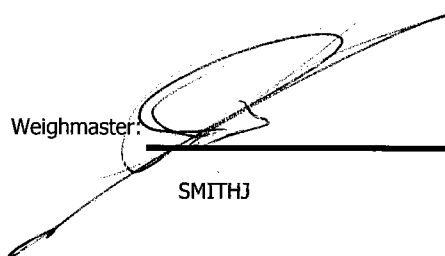
SMITHJ

Indemnification. Customer agrees, by signature above, to indemnify, hold harmless, and defend Republic Services, Inc., its subsidiaries, affiliates, employees, officers and directors from and against any and all liabilities, claims, penalties, forfeitures, suits and the costs and expenses incident thereto, including costs of defense, settlement, and reasonable attorney's fees, which may be incurred, as a result of death or injuries to any person, or damage to any property, contamination of or adverse effects on the environment, caused in whole or in part by the Customer, its employees, or subcontractors in disposing waste at this Facility. In the event Customer delivers Unacceptable Waste (as determined by Republic) Customer agrees to assume all expenses and obligations with the removal and/or resolution of any effects caused by the delivery of such Unacceptable Waste.

Indemnización. Cliente acuerda indemnizar, mantener inmune, y defender Republic Services, Inc., sus subsidiarios, compañías, divisiones, empleados, oficiales y directores contra de cualquiera y de todas responsabilidades, demandas, penas, pérdidas, juicios, pleitos y los costos incidente además, incluyendo costos de defensa, de acuerdo judicial, y de honorarios razonables del abogado, que pueden ser incurridos en, o como resultado de, la muerte o herida personal a cualquier persona, o daños a cualquier característica, propiedad, contaminación de la tierra o efectos ilícitos en esta Facilidad, causado entero o en parte por el cliente, sus empleados, o sus subcontratistas en botar basura en esta Facilidad. En el caso que el Cliente entrega, bota, basura (según lo determinado por Republic) en este Establecimiento basura inaceptable en los reglamentos de este Establecimiento, el Cliente se compromete asumir todos los costos y obligaciones con el retiro y/o la resolución de cualquier dano(s) causado por la entrega de tal basura inaceptable.



NON-HAZARDOUS WASTE MANIFEST

MANIFEST # 12165

GENERATOR INFORMATION

Generator Name: Tronox LLC
Address: P.O. Box 55
City: Henderson County: Clark
State: NV Zip: 89009
Site Location (if different): 560 W. Lake Mead
Henderson, NV 89015 (702) 592-7727

CUSTOMER/BILLING INFORMATION

Billing Name: NGE LLC c/o Northgate Environment Management
Address: 300 Frank Ogawa Plaza, Ste 510
City: Oakland County: Alameda
State: CA Zip: 94612

Table with 5 columns: Republic Services Approval #, Description of Waste, Volume/Weight, Expiration Date, Container Type. Row 1: 38251011244, Soil for disposal, 35.07 TU, 12-31-2011, Tractor with Dump Trailer(s)

*Attach Additional Sheet if necessary

I hereby certify that the above-described materials are non-hazardous wastes as defined by 40 CFR 261 or any applicable state law. Further, that the above named materials are properly classified, described, packaged, marked and labeled, and are in proper condition for transportation according to the applicable regulations of the Department of Transportation.

Susan Crowley (Signature)
Generator/Authorized Agent Name Signature Date Shipped

TRANSPORTER INFORMATION

Transporter Name: Las Vegas Paving DOT # 191949
Address: 4420 S. Decatur Truck Number: 145
Las Vegas, NV 89103 Phone Number: (702) 353-4355

I certify no hazardous waste or other regulated substance was knowingly introduced to the waste while in my custody. The waste transported in this vehicle is the waste identified above, to the best of my knowledge.

Harry McCall (Signature)
Name of Authorized Agent Signature Date Delivered 10-8-10

DISPOSAL SITE INFORMATION

Site Name: Apex Regional Landfill Phone No. (702) 599-5920
Address: 13550 U.S. Hwy 93 Las Vegas, NV

I hereby acknowledge receipt of the above described materials

Name (Print or Type) Signature Date Received 10-8-10

81 Environmental Tech
13550 N Highway 93
Las Vegas, NV 89165

Ticket Type: INBOUND INVOICE

Ticket Number: 2078
Date: 10/08/2010
Time In: 4:25 am
Time Out: 4:47 am

Customer: 001011 - NGE, LLC c/o Northgate Environ Mgmt

Vehicle/Container: 81494P
Contract: Northgate Env. On Site Soils 3825 11
Comment: 3825 10 11244

Gross Weight: 115,260 LB Manual In
Tare Weight: 51,200 LB Manual Out
Net Weight: 64060 LB
Net Tons: 32.03

BOL: 12167

Origin	Yards	Material	Billing Quantity
Not Applicable	0.00 YD	SW CONTAMINATED SOIL	32.03 TN

Driver: _____

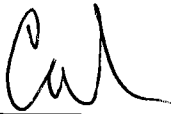

Weighmaster: _____

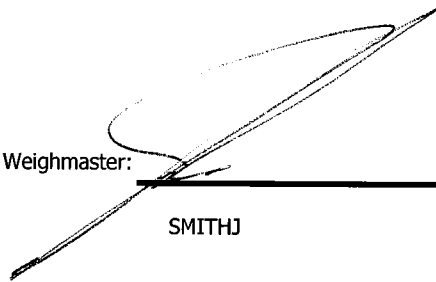

SMITHJ

Indemnification. Customer agrees, by signature above, to indemnify, hold harmless, and defend Republic Services, Inc., its subsidiaries, affiliates, employees, officers and directors from and against any and all liabilities, claims, penalties, forfeitures, suits and the costs and expenses incident thereto, including costs of defense, settlement, and reasonable attorney's fees, which may be incurred, as a result of death or injuries to any person, or damage to any property, contamination of or adverse effects on the environment, caused in whole or in part by the Customer, its employees, or subcontractors in disposing waste at this Facility. In the event Customer delivers Unacceptable Waste (as determined by Republic) Customer agrees to assume all expenses and obligations with the removal and/or resolution of any effects caused by the delivery of such Unacceptable Waste.

Indemnización. Cliente acuerda indemnizar, mantener inmune, y defender Republic Services, Inc., sus subsidiarios, compañías, divisiones, empleados, oficiales y directores contra de cualquiera y de todas responsabilidades, demandas, penas, pérdidas, juicios, pleitos y los costos incidente además, incluyendo costos de defensa, de acuerdo judicial, y de honorarios razonables del abogado, que pueden ser incurridos en, o como resultado de, la muerte o herida personal a cualquier persona, o daños a cualquier característica, propiedad, contaminación de la tierra o efectos ilícitos en esta Facilidad, causado entero o en parte por el cliente, sus empleados, o sus subcontratistas en botar basura en esta Facilidad. En el caso que el Cliente entrega, bota, basura (según lo determinado por Republic) en este Establecimiento basura inaceptable en los reglamentos de este Establecimiento, el Cliente se compromete asumir todos los costos y obligaciones con el retiro y/o la resolución de cualquier dano(s) causado por la entrega de tal basura inaceptable.



NON-HAZARDOUS WASTE MANIFEST

MANIFEST # 12167

GENERATOR INFORMATION

Generator Name: Tronox LLC
Address: P.O. Box 55
City: Henderson County: Clark
State: NV Zip: 89009
Site Location (if different): 560 W. Lake Mead
Henderson, NV 89015 (702) 592-7727

CUSTOMER/BILLING INFORMATION

Billing Name: NGE LLC c/o Northgate Environment Management
Address: 300 Frank Ogawa Plaza, Ste 510
City: Oakland County: Alameda
State: CA Zip: 94612

Table with 5 columns: Republic Services Approval #, Description of Waste, Volume/Weight, Expiration Date, Container Type. Row 1: 38251011244, Soil for disposal, 32.03, 12-31-2011, Tractor with Dump Trailer(s). Row 2: RZ- #

*Attach Additional Sheet if necessary

I hereby certify that the above-described materials are non-hazardous wastes as defined by 40 CFR 261 or any applicable state law. Further, that the above named materials are properly classified, described, packaged, marked and labeled, and are in proper condition for transportation according to the applicable regulations of the Department of Transportation.

Susan Crowley (Name)
Susan Crowley (Signature)
Date Shipped

TRANSPORTER INFORMATION

Transporter Name: Las Vegas Paving DOT # 191949
Address: 4420 S. Decatur Truck Number: 125
Las Vegas, NV 89103 Phone Number: (702) 353-4355

I certify no hazardous waste or other regulated substance was knowingly introduced to the waste while in my custody. The waste transported in this vehicle is the waste identified above, to the best of my knowledge.

Calvin Pagny (Name)
Calvin Pagny (Signature)
Date Delivered: 10-07-10

DISPOSAL SITE INFORMATION

Site Name: Apex Regional Landfill Phone No. (702) 599-5920
Address: 13550 U.S. Hwy 93 Las Vegas, NV

I hereby acknowledge receipt of the above described materials

Jason Smith (Name)
Jason Smith (Signature)
Date Received: 10 8 10

81 Environmental Tech
13550 N Highway 93
Las Vegas, NV 89165

Ticket Type: INBOUND INVOICE

Ticket Number: 2080
Date: 10/08/2010
Time In: 5:33 am
Time Out: 7:15 am

Customer: 001011 - NGE, LLC c/o Northgate Environ Mgmt

Vehicle/Container: 85887P
Contract: Northgate Env. On Site Soils 3825 11
Comment: 3825 10 11244

Gross Weight: 130,720 LB Manual In
Tare Weight: 50,980 LB Scale Out
Net Weight: 79,740 LB
Net Tons: 39.87

BOL: 12157

Origin	Yards	Material	Billing Quantity
Not Applicable	0.00 YD	SW CONTAMINATED SOIL	39.87 TN

Driver:

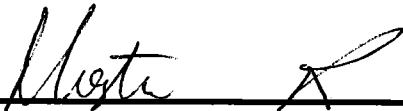

Weighmaster:

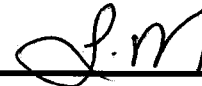

MORENOJ

Indemnification. Customer agrees, by signature above, to indemnify, hold harmless, and defend Republic Services, Inc., its subsidiaries, affiliates, employees, officers and directors from and against any and all liabilities, claims, penalties, forfeitures, suits and the costs and expenses incident thereto, including costs of defense, settlement, and reasonable attorney's fees, which may be incurred, as a result of death or injuries to any person, or damage to any property, contamination of or adverse effects on the environment, caused in whole or in part by the Customer, its employees, or subcontractors in disposing waste at this Facility. In the event Customer delivers Unacceptable Waste (as determined by Republic) Customer agrees to assume all expenses and obligations with the removal and/or resolution of any effects caused by the delivery of such Unacceptable Waste.

Indemnización. Cliente acuerda indemnizar, mantener inmune, y defender Republic Services, Inc., sus subsidiarios, compañías, divisiones, empleados, oficiales y directores contra de cualquiera y de todas responsabilidades, demandas, penas, pérdidas, juicios, pleitos y los costos incidente además, incluyendo costos de defensa, de acuerdo judicial, y de honorarios razonables del abogado, que pueden ser incurridos en, o como resultado de, la muerte o herida personal a cualquier persona, o daños a cualquier característica, propiedad, contaminación de la tierra o efectos ilícitos en esta Facilidad, causado entero o en parte por el cliente, sus empleados, o sus subcontratistas en botar basura en esta Facilidad. En el caso que el Cliente entrega, bota, basura (según lo determinado por Republic) en este Establecimiento basura inaceptable en los reglamentos de este Establecimiento, el Cliente se compromete asumir todos los costos y obligaciones con el retiro y/o la resolución de cualquier dano(s) causado por la entrega de tal basura inaceptable.



NON-HAZARDOUS WASTE MANIFEST

MANIFEST # 12157

GENERATOR INFORMATION

Generator Name: Tronox LLC

Address: P.O. Box 55

City: Henderson County: Clark

State: NV Zip: 89009

Site Location (if different): 560 W. Lake Mead

Henderson, NV 89015 (702) 592-7727

CUSTOMER/BILLING INFORMATION

Billing Name: NGE LLC c/o Northgate Environment Management

Address: 300 Frank Ogawa Plaza, Ste 510

City: Oakland County: Alameda

State: CA Zip: 94612

Republic Services Approval #	Description of Waste	Volume/Weight	Expiration Date	Container Type
38251011244	Soil for disposal		12-31-2011	Tractor with Dump Trailer(s)
	RZ- _____ # _____	39.87 TN		

*Attach Additional Sheet if necessary

I hereby certify that the above-described materials are non-hazardous wastes as defined by 40 CFR 261 or any applicable state law. Further, that the above named materials are properly classified, described, packaged, marked and labeled, and are in proper condition for transportation according to the applicable regulations of the Department of Transportation.

Susan Crowley (Signature) Generator/Authorized Agent Name Date Shipped

TRANSPORTER INFORMATION

Transporter Name: Las Vegas Paving

DOT # 191949

Address: 4420 S. Decatur

Truck Number: R01

Las Vegas, NV 89103

Phone Number: (702) 353-4355

I certify no hazardous waste or other regulated substance was knowingly introduced to the waste while in my custody. The waste transported in this vehicle is the waste identified above, to the best of my knowledge.

(Signature) Name of Authorized Agent Date Delivered 10/7/10

DISPOSAL SITE INFORMATION

Site Name: Apex Regional Landfill

Phone No. (702) 599-5920

Address: 13550 U.S. Hwy 93 Las Vegas, NV

I hereby acknowledge receipt of the above described materials (Signature) Name (Print or Type) Date Received 10-7-10

81 Environmental Tech
13550 N Highway 93
Las Vegas, NV 89165

Ticket Type: INBOUND INVOICE

Ticket Number: 2082
Date: 10/08/2010
Time In: 7:20 am
Time Out: 7:43 am

Customer: 001011 - NGE, LLC c/o Northgate Environ Mgmt

Vehicle/Container: 192391
Contract: Northgate Env. On Site Soils 3825 11
Comment: 3825 10 11244

Gross Weight: 93,560 LB Scale In
Tare Weight: 39,940 LB Manual Out
Net Weight: 53620 LB
Net Tons: 26.81

BOL: 12168

Origin	Yards	Material	Billing	Quantity
Not Applicable	0.00 YD	SW CONTAMINATED SOIL	26.81	TN

Driver: _____

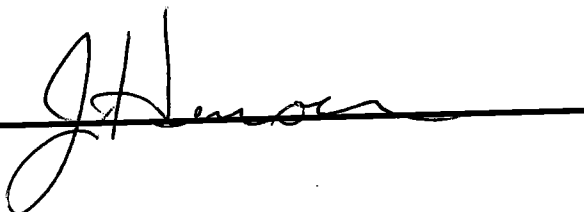

Weighmaster: _____

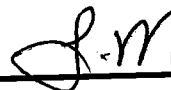

MORENOJ

Indemnification. Customer agrees, by signature above, to indemnify, hold harmless, and defend Republic Services, Inc., its subsidiaries, affiliates, employees, officers and directors from and against any and all liabilities, claims, penalties, forfeitures, suits and the costs and expenses incident thereto, including costs of defense, settlement, and reasonable attorney's fees, which may be incurred, as a result of death or injuries to any person, or damage to any property, contamination of or adverse effects on the environment, caused in whole or in part by the Customer, its employees, or subcontractors in disposing waste at this Facility. In the event Customer delivers Unacceptable Waste (as determined by Republic) Customer agrees to assume all expenses and obligations with the removal and/or resolution of any effects caused by the delivery of such Unacceptable Waste.

Indemnización. Cliente acuerda indemnizar, mantener inmune, y defender Republic Services, Inc., sus subsidiarios, compañías, divisiones, empleados, oficiales y directores contra de cualquiera y de todas responsabilidades, demandas, penas, pérdidas, juicios, pleitos y los costos incidente además, incluyendo costos de defensa, de acuerdo judicial, y de honorarios razonables del abogado, que pueden ser incurridos en, o como resultado de, la muerte o herida personal a cualquier persona, o daños a cualquier característica, propiedad, contaminación de la tierra o efectos ilícitos en esta Facilidad, causado entero o en parte por el cliente, sus empleados, o sus subcontratistas en botar basura en esta Facilidad. En el caso que el Cliente entrega, bota, basura (según lo determinado por Republic) en este Establecimiento basura inaceptable en los reglamentos de este Establecimiento, el Cliente se compromete asumir todos los costos y obligaciones con el retiro y/o la resolución de cualquier dano(s) causado por la entrega de tal basura inaceptable.



NON-HAZARDOUS WASTE MANIFEST

MANIFEST # 12168

GENERATOR INFORMATION

Generator Name: Tronox LLC
Address: P.O. Box 55
City: Henderson County: Clark
State: NV Zip: 89009
Site Location (if different): 560 W. Lake Mead
Henderson, NV 89015 (702) 592-7727

CUSTOMER/BILLING INFORMATION

Billing Name: NGE LLC c/o Northgate Environment Management
Address: 300 Frank Ogawa Plaza, Ste 510
City: Oakland County: Alameda
State: CA Zip: 94612

Table with 5 columns: Republic Services Approval #, Description of Waste, Volume/Weight, Expiration Date, Container Type. Row 1: 38251011244, Soil for disposal, 26.81 TN, 12-31-2011, Tractor with Dump Trailer(s).

*Attach Additional Sheet if necessary

I hereby certify that the above-described materials are non-hazardous wastes as defined by 40 CFR 261 or any applicable state law. Further, that the above named materials are properly classified, described, packaged, marked and labeled, and are in proper condition for transportation according to the applicable regulations of the Department of Transportation.

Susan Crowley (Signature)
Generator/Authorized Agent Name Signature Date Shipped

TRANSPORTER INFORMATION

Transporter Name: Las Vegas Paving DOT # 191949
Address: 4420 S. Decatur Truck Number: 192391
Las Vegas, NV 89103 Phone Number: (702) 353-4355

I certify no hazardous waste or other regulated substance was knowingly introduced to the waste while in my custody. The waste transported in this vehicle is the waste identified above, to the best of my knowledge.

(Signature)
Name of Authorized Agent Signature Date Delivered 10-8-10

DISPOSAL SITE INFORMATION

Site Name: Apex Regional Landfill Phone No. (702) 599-5920
Address: 13550 U.S. Hwy 93 Las Vegas, NV

I hereby acknowledge receipt of the above described materials
Juan Moreno (Signature)
Name (Print or Type) Signature Date Received 10-8-10

81 Environmental Tech
13550 N Highway 93
Las Vegas, NV 89165

Ticket Type: INBOUND INVOICE

Ticket Number: 2083
Date: 10/08/2010
Time In: 7:31 am
Time Out: 8:03 am

Customer: 001011 - NGE, LLC c/o Northgate Environ Mgmt

Vehicle/Container: 71893P
Contract: Northgate Env. On Site Soils 3825 11
Comment: 38251011244

Gross Weight: 126,700 LB Manual In
Tare Weight: 53,680 LB Manual Out
Net Weight: 73020 LB
Net Tons: 36.51

BOL: 12169

Origin	Yards	Material	Billing	Quantity
Not Applicable	0.00 YD	SW CONTAMINATED SOIL	36.51	TN

Driver: _____

Weighmaster: _____

IN - JORDADE OUT - MORENOJ

Indemnification. Customer agrees, by signature above, to indemnify, hold harmless, and defend Republic Services, Inc., its subsidiaries, affiliates, employees, officers and directors from and against any and all liabilities, claims, penalties, forfeitures, suits and the costs and expenses incident thereto, including costs of defense, settlement, and reasonable attorney's fees, which may be incurred, as a result of death or injuries to any person, or damage to any property, contamination of or adverse effects on the environment, caused in whole or in part by the Customer, its employees, or subcontractors in disposing waste at this Facility. In the event Customer delivers Unacceptable Waste (as determined by Republic) Customer agrees to assume all expenses and obligations with the removal and/or resolution of any effects caused by the delivery of such Unacceptable Waste.

Indemnización. Cliente acuerda indemnizar, mantener inmune, y defender Republic Services, Inc., sus subsidiarios, compañías, divisiones, empleados, oficiales y directores contra de cualquiera y de todas responsabilidades, demandas, penas, pérdidas, juicios, pleitos y los costos incidente además, incluyendo costos de defensa, de acuerdo judicial, y de honorarios razonables del abogado, que pueden ser incurridos en, o como resultado de, la muerte o herida personal a cualquier persona, o daños a cualquier característica, propiedad, contaminación de la tierra o efectos ilícitos en esta Facilidad, causado entero o en parte por el cliente, sus empleados, o sus subcontratistas en botar basura en esta Facilidad. En el caso que el Cliente entrega, bota, basura (según lo determinado por Republic) en este Establecimiento basura inaceptable en los reglamentos de este Establecimiento, el Cliente se compromete asumir todos los costos y obligaciones con el retiro y/o la resolución de cualquier dano(s) causado por la entrega de tal basura inaceptable.



NON-HAZARDOUS WASTE MANIFEST

MANIFEST # 12169

GENERATOR INFORMATION

Generator Name: Tronox LLC

Address: P.O. Box 55

City: Henderson County: Clark

State: NV Zip: 89009

Site Location (if different): 560 W. Lake Mead

Henderson, NV 89015 (702) 592-7727

CUSTOMER/BILLING INFORMATION

Billing Name: NGE LLC c/o Northgate Environment Management

Address: 300 Frank Ogawa Plaza, Ste 510

City: Oakland County: Alameda

State: CA Zip: 94612

Republic Services Approval #	Description of Waste	Volume/Weight	Expiration Date	Container Type
38251011244	Soil for disposal		12-31-2011	Tractor with Dump Trailer(s)
	RZ- _____ # _____	36-51		

*Attach Additional Sheet if necessary

I hereby certify that the above-described materials are non-hazardous wastes as defined by 40 CFR 261 or any applicable state law. Further, that the above named materials are properly classified, described, packaged, marked and labeled, and are in proper condition for transportation according to the applicable regulations of the Department of Transportation.

Tom Crowley

Susan Crowley
Generator/Authorized Agent Name

Signature

Date Shipped

TRANSPORTER INFORMATION

Transporter Name: Las Vegas Paving

DOT # 191949

Address: 4420 S. Decatur

Truck Number: JH 7

Las Vegas, NV 89103

Phone Number: (702) 353-4355

I certify no hazardous waste or other regulated substance was knowingly introduced to the waste while in my custody. The waste transported in this vehicle is the waste identified above, to the best of my knowledge.

[Signature]

Name of Authorized Agent

Signature

10-8-10
Date Delivered

DISPOSAL SITE INFORMATION

Site Name: Apex Regional Landfill

Phone No. (702) 599-5920

Address: 13550 U.S. Hwy 93 Las Vegas, NV

I hereby acknowledge receipt of the above described materials

Juan Moreno
Name (Print or Type)

Juan Moreno
Signature

10-8-10
Date Received

81 Environmental Tech
13550 N Highway 93
Las Vegas, NV 89165

Ticket Type: INBOUND INVOICE

Ticket Number: 2084
Date: 10/08/2010
Time In: 7:43 am
Time Out: 8:06 am

Customer: 001011 - NGE, LLC c/o Northgate Environ Mgmt

Vehicle/Container: 85156P
Contract: Northgate Env. On Site Soils 3825 11
Comment: 3825 10 11244

Gross Weight: 125,060 LB Manual In
Tare Weight: 57,960 LB Manual Out
Net Weight: 67100 LB
Net Tons: 33.55

BOL: 1217056020

Origin	Yards	Material	Billing Quantity
Not Applicable	0.00 YD	SW CONTAMINATED SOIL	33.55 TN

Driver: 

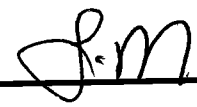
Weighmaster: 

IN - JORDADE OUT - MORENOJ

Indemnification. Customer agrees, by signature above, to indemnify, hold harmless, and defend Republic Services, Inc., its subsidiaries, affiliates, employees, officers and directors from and against any and all liabilities, claims, penalties, forfeitures, suits and the costs and expenses incident thereto, including costs of defense, settlement, and reasonable attorney's fees, which may be incurred, as a result of death or injuries to any person, or damage to any property, contamination of or adverse effects on the environment, caused in whole or in part by the Customer, its employees, or subcontractors in disposing waste at this Facility. In the event Customer delivers Unacceptable Waste (as determined by Republic) Customer agrees to assume all expenses and obligations with the removal and/or resolution of any effects caused by the delivery of such Unacceptable Waste.

Indemnización. Cliente acuerda indemnizar, mantener inmune, y defender Republic Services, Inc., sus subsidiarios, companias, divisiones, empleados, oficiales y directores contra de cualquiera y de todas responsabilidades, demandas, penas, pérdidas, juicios, pleitos y los costos incidente además, incluyendo costos de defensa, de acuerdo judicial, y de honorarios razonables del abogado, que pueden ser incurridos en, o como resultado de, la muerte o herida personal a cualquier persona, o daños a cualquier característica, propiedad, contaminación de la tierra o efectos ilicitos en esta Facilidat, causado entero o en parte por el cliente, sus empleados, o sus subcontratistas en botar basura en esta Facilidat. En el caso que el Cliente entrega, bota, basura (según lo determinado por Republic) en este Establecimiento basura inaceptable en los reglamentos de este Establecimiento, el Cliente se compromete asumir todos los costos y obligaciones con el retiro y/o la resolución de cualquier dano(s) causado por la entrega de tal basura inaceptable.



NON-HAZARDOUS WASTE MANIFEST

MANIFEST # 12170

GENERATOR INFORMATION

Generator Name: Tronox LLCAddress: P.O. Box 55City: Henderson County: ClarkState: NV Zip: 89009Site Location (if different): 560 W. Lake MeadHenderson, NV 89015 (702) 592-7727

CUSTOMER/BILLING INFORMATION

Billing Name: NGE LLC c/o Northgate Environment ManagementAddress: 300 Frank Ogawa Plaza, Ste 510City: Oakland County: AlamedaState: CA Zip: 94612

Republic Services Approval #	Description of Waste	Volume/Weight	Expiration Date	Container Type
38251011244	Soil for disposal		12-31-2011	Tractor with Dump Trailer(s)
	RZ-_____ # _____	33.55 TN		

*Attach Additional Sheet if necessary

I hereby certify that the above-described materials are non-hazardous wastes as defined by 40 CFR 261 or any applicable state law. Further, that the above named materials are properly classified, described, packaged, marked and labeled, and are in proper condition for transportation according to the applicable regulations of the Department of Transportation.

Susan Crowley _____
 Generator/Authorized Agent Name Signature Date Shipped

TRANSPORTER INFORMATION

Transporter Name: Las Vegas PavingDOT # 191949Address: 4420 S. DecaturTruck Number: JH 44Las Vegas, NV 89103Phone Number: (702) 353-4355

I certify no hazardous waste or other regulated substance was knowingly introduced to the waste while in my custody. The waste transported in this vehicle is the waste identified above, to the best of my knowledge.

 Name of Authorized Agent Signature Date Delivered 10-8-10

DISPOSAL SITE INFORMATION

Site Name: Apex Regional LandfillPhone No. (702) 599-5920Address: 13550 U.S. Hwy 93 Las Vegas, NV

I hereby acknowledge receipt of the above described materials
Juan Moreno _____
 Name (Print or Type) Signature Date Received 10-8-10

81 Environmental Tech
13550 N Highway 93
Las Vegas, NV 89165

Ticket Type: INBOUND INVOICE

Ticket Number: 2085
Date: 10/08/2010
Time In: 7:45 am
Time Out: 8:12 am

Customer: 001011 - NGE, LLC c/o Northgate Environ Mgmt

Vehicle/Container: 82515P
Contract: Northgate Env. On Site Soils 3825 11
Comment: 3825 10 11244

Gross Weight: 127,040 LB Manual In
Tare Weight: 53,520 LB Manual Out
Net Weight: 73520 LB
Net Tons: 36.76

BOL: 121172

Origin	Yards	Material	Billing	Quantity
Not Applicable	0.00 YD	SW CONTAMINATED SOIL	36.76	TN

Driver:

St Weir 144

Weighmaster:

J.M.

IN - JORDADE OUT - MORENOJ

Indemnification. Customer agrees, by signature above, to indemnify, hold harmless, and defend Republic Services, Inc., its subsidiaries, affiliates, employees, officers and directors from and against any and all liabilities, claims, penalties, forfeitures, suits and the costs and expenses incident thereto, including costs of defense, settlement, and reasonable attorney's fees, which may be incurred, as a result of death or injuries to any person, or damage to any property, contamination of or adverse effects on the environment, caused in whole or in part by the Customer, its employees, or subcontractors in disposing waste at this Facility. In the event Customer delivers Unacceptable Waste (as determined by Republic) Customer agrees to assume all expenses and obligations with the removal and/or resolution of any effects caused by the delivery of such Unacceptable Waste.

Indemnización. Cliente acuerda indemnizar, mantener inmune, y defender Republic Services, Inc., sus subsidiarios, compañías, divisiones, empleados, oficiales y directores contra de cualquiera y de todas responsabilidades, demandas, penas, pérdidas, juicios, pleitos y los costos incidente además, incluyendo costos de defensa, de acuerdo judicial, y de honorarios razonables del abogado, que pueden ser incurridos en, o como resultado de, la muerte o herida personal a cualquier persona, o daños a cualquier característica, propiedad, contaminación de la tierra o efectos ilícitos en esta Facilidad, causado entero o en parte por el cliente, sus empleados, o sus subcontratistas en botar basura en esta Facilidad. En el caso que el Cliente entrega, bota, basura (según lo determinado por Republic) en este Establecimiento basura inaceptable en los reglamentos de este Establecimiento, el Cliente se compromete asumir todos los costos y obligaciones con el retiro y/o la resolución de cualquier dano(s) causado por la entrega de tal basura inaceptable.



NON-HAZARDOUS WASTE MANIFEST

MANIFEST # 12172

GENERATOR INFORMATION

Generator Name: Tronox LLC

Address: P.O. Box 55

City: Henderson County: Clark

State: NV Zip: 89009

Site Location (if different): 560 W. Lake Mead

Henderson, NV 89015 (702) 592-7727

CUSTOMER/BILLING INFORMATION

Billing Name: NGE LLC c/o Northgate Environment Management

Address: 300 Frank Ogawa Plaza, Ste 510

City: Oakland County: Alameda

State: CA Zip: 94612

Republic Services Approval #	Description of Waste	Volume/Weight	Expiration Date	Container Type
38251011244	Soil for disposal		12-31-2011	Tractor with Dump Trailer(s)
	RZ- #	36-76 TN		

*Attach Additional Sheet if necessary

I hereby certify that the above-described materials are non-hazardous wastes as defined by 40 CFR 261 or any applicable state law. Further, that the above named materials are properly classified, described, packaged, marked and labeled, and are in proper condition for transportation according to the applicable regulations of the Department of Transportation.

Susan Crowley
Generator/Authorized Agent Name

Susan Crowley
Signature

Date Shipped

TRANSPORTER INFORMATION

Transporter Name: Las Vegas Paving

DOT # 191949

Address: 4420 S. Decatur

Truck Number: SR 144

Las Vegas, NV 89103

Phone Number: (702) 353-4355

I certify no hazardous waste or other regulated substance was knowingly introduced to the waste while in my custody. The waste transported in this vehicle is the waste identified above, to the best of my knowledge.

Name of Authorized Agent

St Weir
Signature

10-8-10
Date Delivered

DISPOSAL SITE INFORMATION

Site Name: Apex Regional Landfill

Phone No. (702) 599-5920

Address: 13550 U.S. Hwy 93 Las Vegas, NV

I hereby acknowledge receipt of the above described materials

Juan Moreno
Name (Print or Type)

Juan Moreno
Signature

10-8-10
Date Received

81 Environmental Tech
13550 N Highway 93
Las Vegas, NV 89165

Ticket Type: INBOUND INVOICE

Ticket Number: 2086
Date: 10/08/2010
Time In: 7:43 am
Time Out: 8:22 am

Customer: 001011 - NGE, LLC c/o Northgate Environ Mgmt

Vehicle/Container: 66954P

Contract: Northgate Env. On Site Soils 3825 11
Comment: 3825 10 11244

Gross Weight: 126,280 LB Manual In
Tare Weight: 53,500 LB Manual Out
Net Weight: 72780 LB
Net Tons: 36.39

BOL: 12171

Origin	Yards	Material	Billing	Quantity
Not Applicable	0.00 YD	SW CONTAMINATED SOIL	36.39	TN

Driver: _____

Weighmaster: _____

IN - JORDADE OUT - MORENOJ

Indemnification. Customer agrees, by signature above, to indemnify, hold harmless, and defend Republic Services, Inc., its subsidiaries, affiliates, employees, officers and directors from and against any and all liabilities, claims, penalties, forfeitures, suits and the costs and expenses incident thereto, including costs of defense, settlement, and reasonable attorney's fees, which may be incurred, as a result of death or injuries to any person, or damage to any property, contamination of or adverse effects on the environment, caused in whole or in part by the Customer, its employees, or subcontractors in disposing waste at this Facility. In the event Customer delivers Unacceptable Waste (as determined by Republic) Customer agrees to assume all expenses and obligations with the removal and/or resolution of any effects caused by the delivery of such Unacceptable Waste.

Indemnización. Cliente acuerda indemnizar, mantener inmune, y defender Republic Services, Inc., sus subsidiarios, compañías, divisiones, empleados, oficiales y directores contra de cualquiera y de todas responsabilidades, demandas, penas, pérdidas, juicios, pleitos y los costos incidente además, incluyendo costos de defensa, de acuerdo judicial, y de honorarios razonables del abogado, que pueden ser incurridos en, o como resultado de, la muerte o herida personal a cualquier persona, o daños a cualquier característica, propiedad, contaminación de la tierra o efectos ilícitos en esta Facilidad, causado entero o en parte por el cliente, sus empleados, o sus subcontratistas en botar basura en esta Facilidad. En el caso que el Cliente entrega, bota, basura (según lo determinado por Republic) en este Establecimiento basura inaceptable en los reglamentos de este Establecimiento, el Cliente se compromete asumir todos los costos y obligaciones con el retiro y/o la resolución de cualquier dano(s) causado por la entrega de tal basura inaceptable.



NON-HAZARDOUS WASTE MANIFEST

MANIFEST # 12171

GENERATOR INFORMATION

Generator Name: Tronox LLC

Address: P.O. Box 55

City: Henderson County: Clark

State: NV Zip: 89009

Site Location (if different): 560 W. Lake Mead

Henderson, NV 89015 (702) 592-7727

CUSTOMER/BILLING INFORMATION

Billing Name: NGE LLC c/o Northgate Environment Management

Address: 300 Frank Ogawa Plaza, Ste 510

City: Oakland County: Alameda

State: CA Zip: 94612

Republic Services Approval #	Description of Waste	Volume/Weight	Expiration Date	Container Type
38251011244	Soil for disposal		12-31-2011	Tractor with Dump Trailer(s)
	RZ- _____ # _____	36.39		

*Attach Additional Sheet if necessary

I hereby certify that the above-described materials are non-hazardous wastes as defined by 40 CFR 261 or any applicable state law. Further, that the above named materials are properly classified, described, packaged, marked and labeled, and are in proper condition for transportation according to the applicable regulations of the Department of Transportation.

Susan Crowley

Generator/Authorized Agent Name

Signature

Date Shipped

TRANSPORTER INFORMATION

Transporter Name: Las Vegas Paving

DOT # 191949

Address: 4420 S. Decatur

Truck Number: _____

Las Vegas, NV 89103

Phone Number: (702) 353-4355

I certify no hazardous waste or other regulated substance was knowingly introduced to the waste while in my custody. The waste transported in this vehicle is the waste identified above, to the best of my knowledge.

Name of Authorized Agent

Signature

Date Delivered

DISPOSAL SITE INFORMATION

Site Name: Apex Regional Landfill

Phone No. (702) 599-5920

Address: 13550 U.S. Hwy 93 Las Vegas, NV

I hereby acknowledge receipt of the above described materials

Name (Print or Type)

Signature

Date Received

81 Environmental Tech
13550 N Highway 93
Las Vegas, NV 89165

Ticket Type: INBOUND INVOICE

Ticket Number: 2087
Date: 10/08/2010
Time In: 7:54 am
Time Out: 8:32 am

Customer: 001011 - NGE, LLC c/o Northgate Environ Mgmt

Vehicle/Container: 84893P
Contract: Northgate Env. On Site Soils 3825 11
Comment: ~~303~~ 3825-1011244

Gross Weight: 115,340 LB Manual In
Tare Weight: 39,060 LB Manual Out
Net Weight: 76280 LB
Net Tons: 38.14

12174

Origin	Yards	Material	Billing Quantity
Not Applicable	0.00 YD	SW CONTAMINATED SOIL	38.14 TN

Driver: _____



Weighmaster: _____

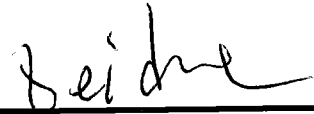

MORENOJ

Indemnification. Customer agrees, by signature above, to indemnify, hold harmless, and defend Republic Services, Inc., its subsidiaries, affiliates, employees, officers and directors from and against any and all liabilities, claims, penalties, forfeitures, suits and the costs and expenses incident thereto, including costs of defense, settlement, and reasonable attorney's fees, which may be incurred, as a result of death or injuries to any person, or damage to any property, contamination of or adverse effects on the environment, caused in whole or in part by the Customer, its employees, or subcontractors in disposing waste at this Facility. In the event Customer delivers Unacceptable Waste (as determined by Republic) Customer agrees to assume all expenses and obligations with the removal and/or resolution of any effects caused by the delivery of such Unacceptable Waste.

Indemnización. Cliente acuerda indemnizar, mantener inmune, y defender Republic Services, Inc., sus subsidiarios, compañías, divisiones, empleados, oficiales y directores contra de cualquiera y de todas responsabilidades, demandas, penas, pérdidas, juicios, pleitos y los costos incidente además, incluyendo costos de defensa, de acuerdo judicial, y de honorarios razonables del abogado, que pueden ser incurridos en, o como resultado de, la muerte o herida personal a cualquier persona, o daños a cualquier característica, propiedad, contaminación de la tierra o efectos ilícitos en esta Facilidad, causado entero o en parte por el cliente, sus empleados, o sus subcontratistas en botar basura en esta Facilidad. En el caso que el Cliente entrega, bota, basura (según lo determinado por Republic) en este Establecimiento basura inaceptable en los reglamentos de este Establecimiento, el Cliente se compromete asumir todos los costos y obligaciones con el retiro y/o la resolución de cualquier dano(s) causado por la entrega de tal basura inaceptable.



NON-HAZARDOUS WASTE MANIFEST

MANIFEST # 12174

GENERATOR INFORMATION

Generator Name: Tronox LLC
 Address: P.O. Box 55
 City: Henderson County: Clark
 State: NV Zip: 89009
 Site Location (if different): 560 W. Lake Mead
Henderson, NV 89015 (702) 592-7727

CUSTOMER/BILLING INFORMATION

Billing Name: NGE LLC c/o Northgate Environment Management
 Address: 300 Frank Ogawa Plaza, Ste 510
 City: Oakland County: Alameda
 State: CA Zip: 94612

Republic Services Approval #	Description of Waste	Volume/Weight	Expiration Date	Container Type
38251011244	Soil for disposal		12-31-2011	Tractor with Dump Trailer(s)
	RZ- _____ # _____	38.14		

*Attach Additional Sheet if necessary

I hereby certify that the above-described materials are non-hazardous wastes as defined by 40 CFR 261 or any applicable state law. Further, that the above named materials are properly classified, described, packaged, marked and labeled, and are in proper condition for transportation according to the applicable regulations of the Department of Transportation.

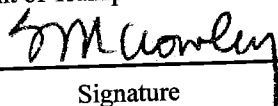
Susan Crowley 
 Generator/Authorized Agent Name Signature Date Shipped

TRANSPORTER INFORMATION

Transporter Name: Las Vegas Paving DOT # 191949
 Address: 4420 S. Decatur Truck Number: 303
Las Vegas, NV 89103 Phone Number: (702) 353-4355

I certify no hazardous waste or other regulated substance was knowingly introduced to the waste while in my custody. The waste transported in this vehicle is the waste identified above, to the best of my knowledge.

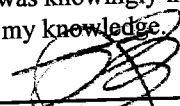
 Name of Authorized Agent Signature Date Delivered 10-8-10

DISPOSAL SITE INFORMATION

Site Name: Apex Regional Landfill Phone No. (702) 599-5920
 Address: 13550 U.S. Hwy 93 Las Vegas, NV

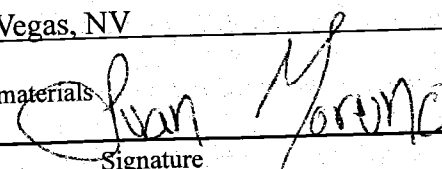
I hereby acknowledge receipt of the above described materials.
Juan Moreno 
 Name (Print or Type) Signature Date Received 10-20-10

81 Environmental Tech
13550 N Highway 93
Las Vegas, NV 89165

Ticket Type: INBOUND INVOICE

Ticket Number: 2088
Date: 10/08/2010
Time In: 7:52 am
Time Out: 8:34 am

Customer: 001011 - NGE, LLC c/o Northgate Environ Mgmt

Vehicle/Container: 73083P
Contract: Northgate Env. On Site Soils 3825 11
Comment: 3825 10 11244

Gross Weight: 126,160 LB Manual In
Tare Weight: 53,960 LB Manual Out
Net Weight: 72200 LB
Net Tons: 36.10

BOL: 12173

Origin	Yards	Material	Billing	Quantity
Not Applicable	0.00 YD	SW CONTAMINATED SOIL	36.10 TN	

Driver: _____

Weighmaster: _____

MORENOJ

Indemnification. Customer agrees, by signature above, to indemnify, hold harmless, and defend Republic Services, Inc., its subsidiaries, affiliates, employees, officers and directors from and against any and all liabilities, claims, penalties, forfeitures, suits and the costs and expenses incident thereto, including costs of defense, settlement, and reasonable attorney's fees, which may be incurred, as a result of death or injuries to any person, or damage to any property, contamination of or adverse effects on the environment, caused in whole or in part by the Customer, its employees, or subcontractors in disposing waste at this Facility. In the event Customer delivers Unacceptable Waste (as determined by Republic) Customer agrees to assume all expenses and obligations with the removal and/or resolution of any effects caused by the delivery of such Unacceptable Waste.

Indemnización. Cliente acuerda indemnizar, mantener inmune, y defender Republic Services, Inc., sus subsidiarios, compañías, divisiones, empleados, oficiales y directores contra de cualquiera y de todas responsabilidades, demandas, penas, pérdidas, juicios, pleitos y los costos incidente además, incluyendo costos de defensa, de acuerdo judicial, y de honorarios razonables del abogado, que pueden ser incurridos en, o como resultado de, la muerte o herida personal a cualquier persona, o daños a cualquier característica, propiedad, contaminación de la tierra o efectos ilícitos en esta Facilidad, causado entero o en parte por el cliente, sus empleados, o sus subcontratistas en botar basura en esta Facilidad. En el caso que el Cliente entrega, bota, basura (según lo determinado por Republic) en este Establecimiento basura inaceptable en los reglamentos de este Establecimiento, el Cliente se compromete asumir todos los costos y obligaciones con el retiro y/o la resolución de cualquier dano(s) causado por la entrega de tal basura inaceptable.



NON-HAZARDOUS WASTE MANIFEST MANIFEST # 12173

GENERATOR INFORMATION

Generator Name: Tronox LLC
 Address: P.O. Box 55
 City: Henderson County: Clark
 State: NV Zip: 89009
 Site Location (if different): 560 W. Lake Mead
Henderson, NV 89015 (702) 592-7727

CUSTOMER/BILLING INFORMATION

Billing Name: NGE LLC c/o Northgate Environment Management
 Address: 300 Frank Ogawa Plaza, Ste 510
 City: Oakland County: Alameda
 State: CA Zip: 94612

Republic Services Approval #	Description of Waste	Volume/Weight	Expiration Date	Container Type
38251011244	Soil for disposal		12-31-2011	Tractor with Dump Trailer(s)
	RZ-_____ # _____			

*Attach Additional Sheet if necessary

I hereby certify that the above-described materials are non-hazardous wastes as defined by 40 CFR 261 or any applicable state law. Further, that the above named materials are properly classified, described, packaged, marked and labeled, and are in proper condition for transportation according to the applicable regulations of the Department of Transportation.

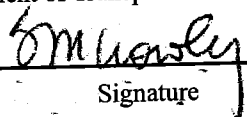
Susan Crowley 
 Generator/Authorized Agent Name Signature Date Shipped

TRANSPORTER INFORMATION

Transporter Name: Las Vegas Paving DOT # 191949
 Address: 4420 S. Decatur Truck Number: _____
Las Vegas, NV 89103 Phone Number: (702) 353-4355

I certify no hazardous waste or other regulated substance was knowingly introduced to the waste while in my custody. The waste transported in this vehicle is the waste identified above, to the best of my knowledge.

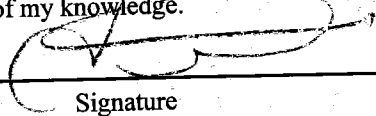
Juan Barra 
 Name of Authorized Agent Signature Date Delivered 10.8.10

DISPOSAL SITE INFORMATION

Site Name: Apex Regional Landfill Phone No. (702) 599-5920
 Address: 13550 U.S. Hwy 93 Las Vegas, NV

I hereby acknowledge receipt of the above described materials
Delida Jorda
 Name (Print or Type) Signature Date Received

81 Environmental Tech
13550 N Highway 93
Las Vegas, NV 89165

Ticket Type: INBOUND INVOICE

Ticket Number: 2089
Date: 10/08/2010
Time In: 8:02 am
Time Out: 8:39 am

Customer: 001011 - NGE, LLC c/o Northgate Environ Mgmt

Vehicle/Container: 81494P
Contract: Northgate Env. On Site Soils 3825 11
Comment: 3825 10 11244

Gross Weight: 110,960 LB Manual In
Tare Weight: 51,220 LB Manual Out
Net Weight: 59740 LB
Net Tons: 29.87

BOL: 12176

Origin	Yards	Material	Billing Quantity
Not Applicable	0.00 YD	SW CONTAMINATED SOIL	29.87 TN

Driver: _____

Weighmaster: _____

MORENOJ

Indemnification. Customer agrees, by signature above, to indemnify, hold harmless, and defend Republic Services, Inc., its subsidiaries, affiliates, employees, officers and directors from and against any and all liabilities, claims, penalties, forfeitures, suits and the costs and expenses incident thereto, including costs of defense, settlement, and reasonable attorney's fees, which may be incurred, as a result of death or injuries to any person, or damage to any property, contamination of or adverse effects on the environment, caused in whole or in part by the Customer, its employees, or subcontractors in disposing waste at this Facility. In the event Customer delivers Unacceptable Waste (as determined by Republic) Customer agrees to assume all expenses and obligations with the removal and/or resolution of any effects caused by the delivery of such Unacceptable Waste.

Indemnización. Cliente acuerda indemnizar, mantener inmune, y defender Republic Services, Inc., sus subsidiarios, compañías, divisiones, empleados, oficiales y directores contra de cualquiera y de todas responsabilidades, demandas, penas, pérdidas, juicios, pleitos y los costos incidente además, incluyendo costos de defensa, de acuerdo judicial, y de honorarios razonables del abogado, que pueden ser incurridos en, o como resultado de, la muerte o herida personal a cualquier persona, o daños a cualquier característica, propiedad, contaminación de la tierra o efectos ilícitos en esta Facilidad, causado entero o en parte por el cliente, sus empleados, o sus subcontratistas en botar basura en esta Facilidad. En el caso que el Cliente entrega, bota, basura (según lo determinado por Republic) en este Establecimiento basura inaceptable en los reglamentos de este Establecimiento, el Cliente se compromete asumir todos los costos y obligaciones con el retiro y/o la resolución de cualquier dano(s) causado por la entrega de tal basura inaceptable.



NON-HAZARDOUS WASTE MANIFEST

MANIFEST # 12176

GENERATOR INFORMATION

Generator Name: Tronox LLC

Address: P.O. Box 55

City: Henderson County: Clark

State: NV Zip: 89009

Site Location (if different): 560 W. Lake Mead

Henderson, NV 89015 (702) 592-7727

CUSTOMER/BILLING INFORMATION

Billing Name: NGE LLC c/o Northgate Environment Management

Address: 300 Frank Ogawa Plaza, Ste 510

City: Oakland County: Alameda

State: CA Zip: 94612

Republic Services Approval #	Description of Waste	Volume/Weight	Expiration Date	Container Type
38251011244	Soil for disposal		12-31-2011	Tractor with Dump Trailer(s)
	RZ- _____ # _____	29.87TN		

*Attach Additional Sheet if necessary

I hereby certify that the above-described materials are non-hazardous wastes as defined by 40 CFR 261 or any applicable state law. Further, that the above named materials are properly classified, described, packaged, marked and labeled, and are in proper condition for transportation according to the applicable regulations of the Department of Transportation.

Susan Crowley (Signature) Generator/Authorized Agent Name Date Shipped

TRANSPORTER INFORMATION

Transporter Name: Las Vegas Paving

DOT # 191949

Address: 4420 S. Decatur

Truck Number: 125

Las Vegas, NV 89103

Phone Number: (702) 353-4355

I certify no hazardous waste or other regulated substance was knowingly introduced to the waste while in my custody. The waste transported in this vehicle is the waste identified above, to the best of my knowledge.

J. Bowyer (Signature) Name of Authorized Agent Date Delivered 10-8-10

DISPOSAL SITE INFORMATION

Site Name: Apex Regional Landfill

Phone No. (702) 599-5920

Address: 13550 U.S. Hwy 93 Las Vegas, NV

I hereby acknowledge receipt of the above described materials

Juan Moreno (Signature) Name (Print or Type) Date Received 10-8-10

81 Environmental Tech
13550 N Highway 93
Las Vegas, NV 89165

Ticket Type: INBOUND INVOICE

Ticket Number: 2090
Date: 10/08/2010
Time In: 7:56 am
Time Out: 8:40 am

Customer: 001011 - NGE, LLC c/o Northgate Environ Mgmt

Vehicle/Container: 81495P
Contract: Northgate Env. On Site Soils 3825 11
Comment: 3825 10 11244

Gross Weight: 117,760 LB Manual In
Tare Weight: 51,020 LB Manual Out
Net Weight: 66,740 LB
Net Tons: 33.37

BOL: 12175

Origin	Yards	Material	Billing	Quantity
Not Applicable	0.00 YD	SW CONTAMINATED SOIL	33.37	TN

Driver: _____

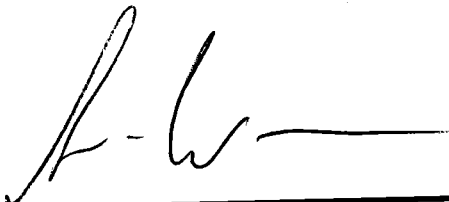

Weighmaster: _____

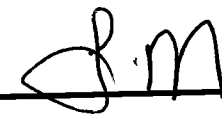

MORENOJ

Indemnification. Customer agrees, by signature above, to indemnify, hold harmless, and defend Republic Services, Inc., its subsidiaries, affiliates, employees, officers and directors from and against any and all liabilities, claims, penalties, forfeitures, suits and the costs and expenses incident thereto, including costs of defense, settlement, and reasonable attorney's fees, which may be incurred, as a result of death or injuries to any person, or damage to any property, contamination of or adverse effects on the environment, caused in whole or in part by the Customer, its employees, or subcontractors in disposing waste at this Facility. In the event Customer delivers Unacceptable Waste (as determined by Republic) Customer agrees to assume all expenses and obligations with the removal and/or resolution of any effects caused by the delivery of such Unacceptable Waste.

Indemnización. Cliente acuerda indemnizar, mantener inmune, y defender Republic Services, Inc., sus subsidiarios, compañías, divisiones, empleados, oficiales y directores contra de cualquiera y de todas responsabilidades, demandas, penas, pérdidas, juicios, pleitos y los costos incidente además, incluyendo costos de defensa, de acuerdo judicial, y de honorarios razonables del abogado, que pueden ser incurridos en, o como resultado de, la muerte o herida personal a cualquier persona, o daños a cualquier característica, propiedad, contaminación de la tierra o efectos ilícitos en esta Facilidad, causado entero o en parte por el cliente, sus empleados, o sus subcontratistas en botar basura en esta Facilidad. En el caso que el Cliente entrega, bota, basura (según lo determinado por Republic) en este Establecimiento basura inaceptable en los reglamentos de este Establecimiento, el Cliente se compromete asumir todos los costos y obligaciones con el retiro y/o la resolución de cualquier dano(s) causado por la entrega de tal basura inaceptable.



NON-HAZARDOUS WASTE MANIFEST

MANIFEST # 12175

GENERATOR INFORMATION

Generator Name: Tronox LLC

Address: P.O. Box 55

City: Henderson County: Clark

State: NV Zip: 89009

Site Location (if different): 560 W. Lake Mead

Henderson, NV 89015 (702) 592-7727

CUSTOMER/BILLING INFORMATION

Billing Name: NGE LLC c/o Northgate Environment Management

Address: 300 Frank Ogawa Plaza, Ste 510

City: Oakland County: Alameda

State: CA Zip: 94612

Republic Services Approval #	Description of Waste	Volume/Weight	Expiration Date	Container Type
38251011244	Soil for disposal		12-31-2011	Tractor with Dump Trailer(s)
	RZ- _____ # _____			

*Attach Additional Sheet if necessary

I hereby certify that the above-described materials are non-hazardous wastes as defined by 40 CFR 261 or any applicable state law. Further, that the above named materials are properly classified, described, packaged, marked and labeled, and are in proper condition for transportation according to the applicable regulations of the Department of Transportation.

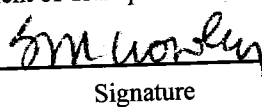
Susan Crowley  _____
 Generator/Authorized Agent Name Signature Date Shipped

TRANSPORTER INFORMATION

Transporter Name: Las Vegas Paving

DOT # 191949

Address: 4420 S. Decatur

Truck Number: 175

Las Vegas, NV 89103

Phone Number: (702) 353-4355

I certify no hazardous waste or other regulated substance was knowingly introduced to the waste while in my custody. The waste transported in this vehicle is the waste identified above, to the best of my knowledge.

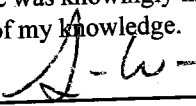
Andrew Walker  _____
 Name of Authorized Agent Signature Date Delivered 10.8.10

DISPOSAL SITE INFORMATION

Site Name: Apex Regional Landfill

Phone No. (702) 599-5920

Address: 13550 U.S. Hwy 93 Las Vegas, NV

I hereby acknowledge receipt of the above described materials

 Name (Print or Type) Signature Date Received

81 Environmental Tech
13550 N Highway 93
Las Vegas, NV 89165

Ticket Type: INBOUND INVOICE

Ticket Number: 2091
Date: 10/08/2010
Time In: 8:12 am
Time Out: 8:47 am

Customer: 001011 - NGE, LLC c/o Northgate Environ Mgmt

Vehicle/Container: 73072P
Contract: Northgate Env. On Site Soils 3825 11
Comment: ~~10~~ 3825-10-11244

Gross Weight: 127,840 LB Manual In
Tare Weight: 50,460 LB Manual Out
Net Weight: 77380 LB
Net Tons: 38.69

BOL: 12177

Origin	Yards	Material	Billing	Quantity
Not Applicable	0.00 YD	SW CONTAMINATED SOIL	38.69	TN

Driver: Robert

Weighmaster: J.M.

IN - GUILFDE OUT - MORENOJ

Indemnification. Customer agrees, by signature above, to indemnify, hold harmless, and defend Republic Services, Inc., its subsidiaries, affiliates, employees, officers and directors from and against any and all liabilities, claims, penalties, forfeitures, suits and the costs and expenses incident thereto, including costs of defense, settlement, and reasonable attorney's fees, which may be incurred, as a result of death or injuries to any person, or damage to any property, contamination of or adverse effects on the environment, caused in whole or in part by the Customer, its employees, or subcontractors in disposing waste at this Facility. In the event Customer delivers Unacceptable Waste (as determined by Republic) Customer agrees to assume all expenses and obligations with the removal and/or resolution of any effects caused by the delivery of such Unacceptable Waste.

Indemnización. Cliente acuerda indemnizar, mantener inmune, y defender Republic Services, Inc., sus subsidiarios, compañías, divisiones, empleados, oficiales y directores contra de cualquiera y de todas responsabilidades, demandas, penas, pérdidas, juicios, pleitos y los costos incidente además, incluyendo costos de defensa, de acuerdo judicial, y de honorarios razonables del abogado, que pueden ser incurridos en, o como resultado de, la muerte o herida personal a cualquier persona, o daños a cualquier característica, propiedad, contaminación de la tierra o efectos ilícitos en esta Facilidad, causado entero o en parte por el cliente, sus empleados, o sus subcontratistas en botar basura en esta Facilidad. En el caso que el Cliente entrega, bota, basura (según lo determinado por Republic) en este Establecimiento basura inaceptable en los reglamentos de este Establecimiento, el Cliente se compromete asumir todos los costos y obligaciones con el retiro y/o la resolución de cualquier dano(s) causado por la entrega de tal basura inaceptable.



NON-HAZARDOUS WASTE MANIFEST

MANIFEST # 12177

GENERATOR INFORMATION

Generator Name: Tronox LLC
Address: P.O. Box 55
City: Henderson County: Clark
State: NV Zip: 89009
Site Location (if different): 560 W. Lake Mead
Henderson, NV 89015 (702) 592-7727

CUSTOMER/BILLING INFORMATION

Billing Name: NGE LLC c/o Northgate Environment Management
Address: 300 Frank Ogawa Plaza, Ste 510
City: Oakland County: Alameda
State: CA Zip: 94612

Table with 5 columns: Republic Services Approval #, Description of Waste, Volume/Weight, Expiration Date, Container Type. Row 1: 38251011244, Soil for disposal, 38.69, 12-31-2011, Tractor with Dump Trailer(s).

*Attach Additional Sheet if necessary

I hereby certify that the above-described materials are non-hazardous wastes as defined by 40 CFR 261 or any applicable state law. Further, that the above named materials are properly classified, described, packaged, marked and labeled, and are in proper condition for transportation according to the applicable regulations of the Department of Transportation.

Susan Crowley (Signature) 10-8-10 (Date Shipped)
Generator/Authorized Agent Name Signature Date Shipped

TRANSPORTER INFORMATION

Transporter Name: Las Vegas Paving DOT # 191949
Address: 4420 S. Decatur Truck Number:
Las Vegas, NV 89103 Phone Number: (702) 353-4355

I certify no hazardous waste or other regulated substance was knowingly introduced to the waste while in my custody. The waste transported in this vehicle is the waste identified above, to the best of my knowledge.

Robert Lee (Signature) 10.8.10 (Date Delivered)
Name of Authorized Agent Signature Date Delivered

DISPOSAL SITE INFORMATION

Site Name: Apex Regional Landfill Phone No. (702) 599-5920
Address: 13550 U.S. Hwy 93 Las Vegas, NV

I hereby acknowledge receipt of the above described materials
Beck Jordan (Signature) 10-8-10 (Date Received)
Name (Print or Type) Signature Date Received

81

Environmental Tech
13550 N Highway 93
Las Vegas, NV 89165

Ticket Type: INBOUND INVOICE

Ticket Number: 2092
Date: 10/08/2010
Time In: 8:21 am
Time Out: 8:56 am

Customer: 001011 - NGE, LLC c/o Northgate Environ Mgmt

Vehicle/Container: 81496P

Contract: Northgate Env. On Site Soils 3825 11

Comment: ~~115~~ 3825-10-11244

Gross Weight: 107,220 LB Manual In
Tare Weight: 50,380 LB Manual Out
Net Weight: 56840 LB
Net Tons: 28.42

BOL: 12178

Origin	Yards	Material	Billing	Quantity
Not Applicable	0.00 YD	SW CONTAMINATED SOIL	28.42	TN

Driver: _____



Weighmaster: _____



IN - GUILFDE OUT - MORENOJ

Indemnification. Customer agrees, by signature above, to indemnify, hold harmless, and defend Republic Services, Inc., its subsidiaries, affiliates, employees, officers and directors from and against any and all liabilities, claims, penalties, forfeitures, suits and the costs and expenses incident thereto, including costs of defense, settlement, and reasonable attorney's fees, which may be incurred, as a result of death or injuries to any person, or damage to any property, contamination of or adverse effects on the environment, caused in whole or in part by the Customer, its employees, or subcontractors in disposing waste at this Facility. In the event Customer delivers Unacceptable Waste (as determined by Republic) Customer agrees to assume all expenses and obligations with the removal and/or resolution of any effects caused by the delivery of such Unacceptable Waste.

Indemnización. Cliente acuerda indemnizar, mantener inmune, y defender Republic Services, Inc., sus subsidiarios, companias, divisiones, empleados, oficiales y directores contra de cualquiera y de todas responsabilidades, demandas, penas, pérdidas, juicios, pleitos y los costos incidente además, incluyendo costos de defensa, de acuerdo judicial, y de honorarios razonables del abogado, que pueden ser incurridos en, o como resultado de, la muerte o herida personal a cualquier persona, o daños a cualquier característica, propiedad, contaminación de la tierra o efectos ilicitos en esta Facilidad, causado entero o en parte por el cliente, sus empleados, o sus subcontratistas en botar basura en esta Facilidad. En el caso que el Cliente entrega, bota, basura (según lo determinado por Republic) en este Establecimiento basura inaceptable en los reglamentos de este Establecimiento, el Cliente se compromete asumir todos los costos y obligaciones con el retiro y/o la resolución de cualquier dano(s) causado por la entrega de tal basura inaceptable.



NON-HAZARDOUS WASTE MANIFEST

MANIFEST # 12178

GENERATOR INFORMATION

Generator Name: Tronox LLC
Address: P.O. Box 55
City: Henderson County: Clark
State: NV Zip: 89009
Site Location (if different): 560 W. Lake Mead
Henderson, NV 89015 (702) 592-7727

CUSTOMER/BILLING INFORMATION

Billing Name: NGE LLC c/o Northgate Environment Management
Address: 300 Frank Ogawa Plaza, Ste 510
City: Oakland County: Alameda
State: CA Zip: 94612

Table with 5 columns: Republic Services Approval #, Description of Waste, Volume/Weight, Expiration Date, Container Type. Row 1: 38251011244, Soil for disposal, 28.42, 12-31-2011, Tractor with Dump Trailer(s).

*Attach Additional Sheet if necessary

I hereby certify that the above-described materials are non-hazardous wastes as defined by 40 CFR 261 or any applicable state law. Further, that the above named materials are properly classified, described, packaged, marked and labeled, and are in proper condition for transportation according to the applicable regulations of the Department of Transportation.

Susan Crowley
Generator/Authorized Agent Name Signature Date Shipped

TRANSPORTER INFORMATION

Transporter Name: Las Vegas Paving DOT # 191949
Address: 4420 S. Decatur Truck Number: 145
Las Vegas, NV 89103 Phone Number: (702) 353-4355

I certify no hazardous waste or other regulated substance was knowingly introduced to the waste while in my custody. The waste transported in this vehicle is the waste identified above, to the best of my knowledge.

Name of Authorized Agent Signature Date Delivered 10.8.10

DISPOSAL SITE INFORMATION

Site Name: Apex Regional Landfill Phone No. (702) 599-5920
Address: 13550 U.S. Hwy 93 Las Vegas, NV

I hereby acknowledge receipt of the above described materials
Name (Print or Type) Signature Date Received 10.8.10

81 Environmental Tech
13550 N Highway 93
Las Vegas, NV 89165

Ticket Type: INBOUND INVOICE

Ticket Number: 2095
Date: 10/08/2010
Time In: 8:41 am
Time Out: 9:08 am

Customer: 001011 - NGE, LLC c/o Northgate Environ Mgmt

Vehicle/Container: 44264A
Contract: Northgate Env. On Site Soils 3825 11
Comment: ~~100~~ 3825-10-11244

Gross Weight: 131,900 LB Manual In
Tare Weight: 56,280 LB Manual Out
Net Weight: 75620 LB
Net Tons: 37.81

12182

Origin	Yards	Material	Billing Quantity
Not Applicable	0.00 YD	SW CONTAMINATED SOIL	37.81 TN

Driver: NR

Weighmaster: [Signature]
GUILFDE

Indemnification of Customer agrees, by signature above, to indemnify, hold harmless, and defend Republic Services, Inc. and its subsidiaries, affiliates, employees, officers and directors from and against any and all liabilities, claims, penalties, forfeitures, suits and the costs and expenses incident thereto, including costs of defense, settlement, and reasonable attorney's fees, which may be incurred, as a result of death or injuries to any person, or damage to any property, contamination of or adverse effects on the environment, caused in whole or in part by the Customer, its employees or subcontractors in disposing waste at this Facility. In the event Customer delivers Unacceptable Waste (as determined by Republic) Customer agrees to assume all expenses and obligations with the removal and/or resolution of any effects caused by the delivery of such Unacceptable Waste.

Indemnización: Cliente acuerda indemnizar, mantener inmune, y defender Republic Services, Inc., sus subsidiarios, compañías, divisiones, empleados, oficiales y directores contra de cualquiera y de todas responsabilidades, demandas, penas, pérdidas, juicios, pleitos y los costos incidente además, incluyendo costos de defensa, de acuerdo judicial, y de honorarios razonables del abogado, que pueden ser incurridos en, o como resultado de, la muerte o herida personal a cualquier persona, daños a cualquier característica, propiedad, contaminación de la tierra o efectos nocivos en esta Facility, causados en entero o en parte por el cliente, sus empleados, o sus subcontratistas en botar basura en esta Facility. En el caso que el Cliente entrega, bota, basura (según lo determinado por Republic) en este Establecimiento, el Cliente se compromete a asumir todos los costos y obligaciones con el retiro y/o la resolución de cualquier daño(s) causado por la entrega de tal basura inaceptable.



NON-HAZARDOUS WASTE MANIFEST

MANIFEST # 12182

GENERATOR INFORMATION

Generator Name: Tronox LLC
Address: P.O. Box 55
City: Henderson County: Clark
State: NV Zip: 89009
Site Location (if different): 560 W. Lake Mead
Henderson, NV 89015 (702) 592-7727

CUSTOMER/BILLING INFORMATION

Billing Name: NGE LLC c/o Northgate Environment Management
Address: 300 Frank Ogawa Plaza, Ste 510
City: Oakland County: Alameda
State: CA Zip: 94612

Table with 5 columns: Republic Services Approval #, Description of Waste, Volume/Weight, Expiration Date, Container Type. Row 1: 38251011244, Soil for disposal, 37.81, 12-31-2011, Tractor with Dump Trailer(s).

*Attach Additional Sheet if necessary

I hereby certify that the above-described materials are non-hazardous wastes as defined by 40 CFR 261 or any applicable state law. Further, that the above named materials are properly classified, described, packaged, marked and labeled, and are in proper condition for transportation according to the applicable regulations of the Department of Transportation.

Susan Crowley (Signature)
Generator/Authorized Agent Name Signature Date Shipped

TRANSPORTER INFORMATION

Transporter Name: Las Vegas Paving DOT # 191949
Address: 4420 S. Decatur Truck Number: 100
Las Vegas, NV 89103 Phone Number: (702) 353-4355

I certify no hazardous waste or other regulated substance was knowingly introduced to the waste while in my custody. The waste transported in this vehicle is the waste identified above, to the best of my knowledge.

(Signature) 10-8-10
Name of Authorized Agent Signature Date Delivered

DISPOSAL SITE INFORMATION

Site Name: Apex Regional Landfill Phone No. (702) 599-5920
Address: 13550 U.S. Hwy 93 Las Vegas, NV

I hereby acknowledge receipt of the above described materials
Debbie Guilfoile (Signature) 10-8-10
Name (Print or Type) Signature Date Received

81 Environmental Tech
13550 N Highway 93
Las Vegas, NV 89165

Ticket Type: INBOUND INVOICE

Ticket Number: 2096
Date: 10/08/2010
Time In: 8:44 am
Time Out: 9:14 am

Customer: 001011 - NGE, LLC c/o Northgate Environ Mgmt

Vehicle/Container: 58507P
Contract: Northgate Env. On Site Soils 3825 11
Comment: ~~1920~~ 3825-10-11244

Gross Weight: 125,960 LB Manual In
Tare Weight: 54,300 LB Manual Out
Net Weight: 71660 LB
Net Tons: 35.83

BOL: 12180

Origin	Yards	Material	Billing	Quantity
Not Applicable	0.00 YD	SW CONTAMINATED SOIL	35.83	TN

Driver: _____

Weighmaster: _____

IN - GUILFDE OUT - MORENOJ

Indemnification. Customer agrees, by signature above, to indemnify, hold harmless, and defend Republic Services, Inc., its subsidiaries, affiliates, employees, officers and directors from and against any and all liabilities, claims, penalties, forfeitures, suits and the costs and expenses incident thereto, including costs of defense, settlement, and reasonable attorney's fees, which may be incurred, as a result of death or injuries to any person, or damage to any property, contamination of or adverse effects on the environment, caused in whole or in part by the Customer, its employees, or subcontractors in disposing waste at this Facility. In the event Customer delivers Unacceptable Waste (as determined by Republic) Customer agrees to assume all expenses and obligations with the removal and/or resolution of any effects caused by the delivery of such Unacceptable Waste.

Indemnización. Cliente acuerda indemnizar, mantener inmune, y defender Republic Services, Inc., sus subsidiarios, compañías, divisiones, empleados, oficiales y directores contra de cualquiera y de todas responsabilidades, demandas, penas, pérdidas, juicios, pleitos y los costos incidente además, incluyendo costos de defensa, de acuerdo judicial, y de honorarios razonables del abogado, que pueden ser incurridos en, o como resultado de, la muerte o herida personal a cualquier persona, o daños a cualquier característica, propiedad, contaminación de la tierra o efectos ilícitos en esta Facilidad, causado entero o en parte por el cliente, sus empleados, o sus subcontratistas en botar basura en esta Facilidad. En el caso que el Cliente entrega, bota, basura (según lo determinado por Republic) en este Establecimiento basura inaceptable en los reglamentos de este Establecimiento, el Cliente se compromete asumir todos los costos y obligaciones con el retiro y/o la resolución de cualquier dano(s) causado por la entrega de tal basura inaceptable.



NON-HAZARDOUS WASTE MANIFEST

MANIFEST # 12180

GENERATOR INFORMATION

Generator Name: Tronox LLC

Address: P.O. Box 55

City: Henderson County: Clark

State: NV Zip: 89009

Site Location (if different): 560 W. Lake Mead

Henderson, NV 89015 (702) 592-7727

CUSTOMER/BILLING INFORMATION

Billing Name: NGE LLC c/o Northgate Environment Management

Address: 300 Frank Ogawa Plaza, Ste 510

City: Oakland County: Alameda

State: CA Zip: 94612

Republic Services Approval #	Description of Waste	Volume/Weight	Expiration Date	Container Type
38251011244	Soil for disposal		12-31-2011	Tractor with Dump Trailer(s)
	RZ- _____ # _____	35.83		

*Attach Additional Sheet if necessary

I hereby certify that the above-described materials are non-hazardous wastes as defined by 40 CFR 261 or any applicable state law. Further, that the above named materials are properly classified, described, packaged, marked and labeled, and are in proper condition for transportation according to the applicable regulations of the Department of Transportation.

Susan Crowley
Generator/Authorized Agent Name

Susan Crowley
Signature

Date Shipped

TRANSPORTER INFORMATION

Transporter Name: Las Vegas Paving

DOT # 191949

Address: 4420 S. Decatur

Truck Number: 1020

Las Vegas, NV 89103

Phone Number: (702) 353-4355

I certify no hazardous waste or other regulated substance was knowingly introduced to the waste while in my custody. The waste transported in this vehicle is the waste identified above, to the best of my knowledge.

Name of Authorized Agent

Signature

Date Delivered

DISPOSAL SITE INFORMATION

Site Name: Apex Regional Landfill

Phone No. (702) 599-5920

Address: 13550 U.S. Hwy 93 Las Vegas, NV

I hereby acknowledge receipt of the above described materials

Juan Moreno
Name (Print or Type)

Juan Moreno
Signature

10-8-10
Date Received

81 Environmental Tech
13550 N Highway 93
Las Vegas, NV 89165

Ticket Type: INBOUND INVOICE

Ticket Number: 2097
Date: 10/08/2010
Time In: 9:22 am
Time Out: 9:22 am

Customer: 001011 - NGE, LLC c/o Northgate Environ Mgmt

Vehicle/Container: 86673P

Contract: Northgate Env. On Site Soils 3825 11

Comment: 3825 10 11244

Gross Weight: 108,200 LB Manual In
Tare Weight: 54,960 LB Manual Out
Net Weight: 53240 LB
Net Tons: 26.62

BOL: 12183

Origin	Yards	Material	Billing	Quantity
Not Applicable	0.00 YD	SW CONTAMINATED SOIL	26.62 TN	

Driver: _____

Weighmaster: _____

MORENOJ

Indemnification. Customer agrees, by signature above, to indemnify, hold harmless, and defend Republic Services, Inc., its subsidiaries, affiliates, employees, officers and directors from and against any and all liabilities, claims, penalties, forfeitures, suits and the costs and expenses incident thereto, including costs of defense, settlement, and reasonable attorney's fees, which may be incurred, as a result of death or injuries to any person, or damage to any property, contamination of or adverse effects on the environment, caused in whole or in part by the Customer, its employees, or subcontractors in disposing waste at this Facility. In the event Customer delivers Unacceptable Waste (as determined by Republic) Customer agrees to assume all expenses and obligations with the removal and/or resolution of any effects caused by the delivery of such Unacceptable Waste.

Indemnización. Cliente acuerda indemnizar, mantener inmune, y defender Republic Services, Inc., sus subsidiarios, compañías, divisiones, empleados, oficiales y directores contra de cualquiera y de todas responsabilidades, demandas, penas, pérdidas, juicios, pleitos y los costos incidente además, incluyendo costos de defensa, de acuerdo judicial, y de honorarios razonables del abogado, que pueden ser incurridos en, o como resultado de, la muerte o herida personal a cualquier persona, o daños a cualquier característica, propiedad, contaminación de la tierra o efectos ilícitos en esta Facilidad, causado entero o en parte por el cliente, sus empleados, o sus subcontratistas en botar basura en esta Facilidad. En el caso que el Cliente entrega, bota, basura (según lo determinado por Republic) en este Establecimiento basura inaceptable en los reglamentos de este Establecimiento, el Cliente se compromete asumir todos los costos y obligaciones con el retiro y/o la resolución de cualquier dano(s) causado por la entrega de tal basura inaceptable.



NON-HAZARDOUS WASTE MANIFEST

MANIFEST # 12183

GENERATOR INFORMATION

Generator Name: Tronox LLC
 Address: P.O. Box 55
 City: Henderson County: Clark
 State: NV Zip: 89009
 Site Location (if different): 560 W. Lake Mead
Henderson, NV 89015 (702) 592-7727

CUSTOMER/BILLING INFORMATION

Billing Name: NGE LLC c/o Northgate Environment Management
 Address: 300 Frank Ogawa Plaza, Ste 510
 City: Oakland County: Alameda
 State: CA Zip: 94612

Republic Services Approval #	Description of Waste	Volume/Weight	Expiration Date	Container Type
38251011244	Soil for disposal		12-31-2011	Tractor with Dump Trailer(s)
	RZ-_____#_____	26.62		

*Attach Additional Sheet if necessary

I hereby certify that the above-described materials are non-hazardous wastes as defined by 40 CFR 261 or any applicable state law. Further, that the above named materials are properly classified, described, packaged, marked and labeled, and are in proper condition for transportation according to the applicable regulations of the Department of Transportation.

Susan Crowley _____
 Generator/Authorized Agent Name Signature Date Shipped

TRANSPORTER INFORMATION

Transporter Name: Las Vegas Paving DOT # 191949
 Address: 4420 S. Decatur Truck Number: ST 58
Las Vegas, NV 89103 Phone Number: (702) 353-4355

I certify no hazardous waste or other regulated substance was knowingly introduced to the waste while in my custody. The waste transported in this vehicle is the waste identified above, to the best of my knowledge.

 Name of Authorized Agent Signature Date Delivered 10-8-10

DISPOSAL SITE INFORMATION

Site Name: Apex Regional Landfill Phone No. (702) 599-5920
 Address: 13550 U.S. Hwy 93 Las Vegas, NV

I hereby acknowledge receipt of the above described materials
Juan Moreno _____
 Name (Print or Type) Signature Date Received 10-8-10

81 Environmental Tech
13550 N Highway 93
Las Vegas, NV 89165

Ticket Type: INBOUND INVOICE

Ticket Number: 2098
Date: 10/08/2010
Time In: 9:23 am
Time Out: 9:23 am

Customer: 001011 - NGE, LLC c/o Northgate Environ Mgmt

Vehicle/Container: 60573P
Contract: Northgate Env. On Site Soils 3825 11

3825-10-11244

Gross Weight: 133,860 LB Manual In
Tare Weight: 58,360 LB Manual Out
Net Weight: 75500 LB
Net Tons: 37.75

BOL: 112179

Origin	Yards	Material	Billing	Quantity
Not Applicable	0.00 YD	SW CONTAMINATED SOIL	37.75	TN

Driver:



Weighmaster:

05

MORENOJ

Indemnification. Customer agrees, by signature above, to indemnify, hold harmless, and defend Republic Services, Inc., its subsidiaries, affiliates, employees, officers and directors from and against any and all liabilities, claims, penalties, forfeitures, suits and the costs and expenses incident thereto, including costs of defense, settlement, and reasonable attorney's fees, which may be incurred, as a result of death or injuries to any person, or damage to any property, contamination of or adverse effects on the environment, caused in whole or in part by the Customer, its employees, or subcontractors in disposing waste at this Facility. In the event Customer delivers Unacceptable Waste (as determined by Republic) Customer agrees to assume all expenses and obligations with the removal and/or resolution of any effects caused by the delivery of such Unacceptable Waste.

Indemnización. Cliente acuerda indemnizar, mantener inmune, y defender Republic Services, Inc., sus subsidiarios, compañías, divisiones, empleados, oficiales y directores contra de cualquiera y de todas responsabilidades, demandas, penas, pérdidas, juicios, pleitos y los costos incidente además, incluyendo costos de defensa, de acuerdo judicial, y de honorarios razonables del abogado, que pueden ser incurridos en, o como resultado de, la muerte o herida personal a cualquier persona, o daños a cualquier característica, propiedad, contaminación de la tierra o efectos ilícitos en esta Facilidad, causado entero o en parte por el cliente, sus empleados, o sus subcontratistas en botar basura en esta Facilidad. En el caso que el Cliente entrega, bota, basura (según lo determinado por Republic) en este Establecimiento basura inaceptable en los reglamentos de este Establecimiento, el Cliente se compromete asumir todos los costos y obligaciones con el retiro y/o la resolución de cualquier dano(s) causado por la entrega de tal basura inaceptable.



NON-HAZARDOUS WASTE MANIFEST

MANIFEST # 12179

GENERATOR INFORMATION

Generator Name: Tronox LLC
Address: P.O. Box 55
City: Henderson County: Clark
State: NV Zip: 89009
Site Location (if different): 560 W. Lake Mead
Henderson, NV 89015 (702) 592-7727

CUSTOMER/BILLING INFORMATION

Billing Name: NGE LLC c/o Northgate Environment Management
Address: 300 Frank Ogawa Plaza, Ste 510
City: Oakland County: Alameda
State: CA Zip: 94612

Table with 5 columns: Republic Services Approval #, Description of Waste, Volume/Weight, Expiration Date, Container Type. Row 1: 38251011244, Soil for disposal, 37.75, 12-31-2011, Tractor with Dump Trailer(s).

*Attach Additional Sheet if necessary

I hereby certify that the above-described materials are non-hazardous wastes as defined by 40 CFR 261 or any applicable state law. Further, that the above named materials are properly classified, described, packaged, marked and labeled, and are in proper condition for transportation according to the applicable regulations of the Department of Transportation.

Susan Crowley (Signature)
Generator/Authorized Agent Name Signature Date Shipped

TRANSPORTER INFORMATION

Transporter Name: Las Vegas Paving DOT # 191949
Address: 4420 S. Decatur Truck Number:
Las Vegas, NV 89103 Phone Number: (702) 353-4355

I certify no hazardous waste or other regulated substance was knowingly introduced to the waste while in my custody. The waste transported in this vehicle is the waste identified above, to the best of my knowledge.

Name of Authorized Agent Signature Date Delivered (10-8-10)

DISPOSAL SITE INFORMATION

Site Name: Apex Regional Landfill Phone No. (702) 599-5920
Address: 13550 U.S. Hwy 93 Las Vegas, NV

I hereby acknowledge receipt of the above described materials (Signature)
Name (Print or Type) Signature Date Received (10-8-10)

81 Environmental Tech
13550 N Highway 93
Las Vegas, NV 89165

Ticket Type: INBOUND INVOICE

Ticket Number: 2099
Date: 10/08/2010
Time In: 8:45 am
Time Out: 9:26 am

Customer: 001011 - NGE, LLC c/o Northgate Environ Mgmt

Vehicle/Container: 84462P
Contract: Northgate Env. On Site Soils 3825 11
Comment: ~~110~~ 3825-10-11244

Gross Weight: 129,460 LB Manual In
Tare Weight: 49,780 LB Manual Out
Net Weight: 79680 LB
Net Tons: 39.84

BOL: 12181

Origin	Yards	Material	Billing Quantity
Not Applicable	0.00 YD	SW CONTAMINATED SOIL	39.84 TN

Driver: _____



Weighmaster: _____

DS

IN - GUILFDE OUT - MORENOJ

Indemnification. Customer agrees, by signature above, to indemnify, hold harmless, and defend Republic Services, Inc., its subsidiaries, affiliates, employees, officers and directors from and against any and all liabilities, claims, penalties, forfeitures, suits and the costs and expenses incident thereto, including costs of defense, settlement, and reasonable attorney's fees, which may be incurred, as a result of death or injuries to any person, or damage to any property, contamination of or adverse effects on the environment, caused in whole or in part by the Customer, its employees, or subcontractors in disposing waste at this Facility. In the event Customer delivers Unacceptable Waste (as determined by Republic) Customer agrees to assume all expenses and obligations with the removal and/or resolution of any effects caused by the delivery of such Unacceptable Waste.

Indemnización. Cliente acuerda indemnizar, mantener inmune, y defender Republic Services, Inc., sus subsidiarios, compañías, divisiones, empleados, oficiales y directores contra de cualquiera y de todas responsabilidades, demandas, penas, pérdidas, juicios, pleitos y los costos incidente además, incluyendo costos de defensa, de acuerdo judicial, y de honorarios razonables del abogado, que pueden ser incurridos en, o como resultado de, la muerte o herida personal a cualquier persona, o daños a cualquier característica, propiedad, contaminación de la tierra o efectos ilícitos en esta Facilidad, causado entero o en parte por el cliente, sus empleados, o sus subcontratistas en botar basura en esta Facilidad. En el caso que el Cliente entrega, bota, basura (según lo determinado por Republic) en este Establecimiento basura inaceptable en los reglamentos de este Establecimiento, el Cliente se compromete asumir todos los costos y obligaciones con el retiro y/o la resolución de cualquier dano(s) causado por la entrega de tal basura inaceptable.



NON-HAZARDOUS WASTE MANIFEST

MANIFEST # 12181

GENERATOR INFORMATION

Generator Name: Tronox LLC

Address: P.O. Box 55

City: Henderson County: Clark

State: NV Zip: 89009

Site Location (if different): 560 W. Lake Mead

Henderson, NV 89015 (702) 592-7727

CUSTOMER/BILLING INFORMATION

Billing Name: NGE LLC c/o Northgate Environment Management

Address: 300 Frank Ogawa Plaza, Ste 510

City: Oakland County: Alameda

State: CA Zip: 94612

Republic Services Approval #	Description of Waste	Volume/Weight	Expiration Date	Container Type
38251011244	Soil for disposal		12-31-2011	Tractor with Dump Trailer(s)
	RZ- _____ # _____	39.84		

*Attach Additional Sheet if necessary

I hereby certify that the above-described materials are non-hazardous wastes as defined by 40 CFR 261 or any applicable state law. Further, that the above named materials are properly classified, described, packaged, marked and labeled, and are in proper condition for transportation according to the applicable regulations of the Department of Transportation.

Susan Crowley

Susan Crowley

Generator/Authorized Agent Name

Signature

Date Shipped

TRANSPORTER INFORMATION

Transporter Name: Las Vegas Paving

DOT # 191949

Address: 4420 S. Decatur

Truck Number: _____

Las Vegas, NV 89103

Phone Number: (702) 353-4355

I certify no hazardous waste or other regulated substance was knowingly introduced to the waste while in my custody. The waste transported in this vehicle is the waste identified above, to the best of my knowledge.

Name of Authorized Agent

Signature

Date Delivered

10-8-10

DISPOSAL SITE INFORMATION

Site Name: Apex Regional Landfill

Phone No. (702) 599-5920

Address: 13550 U.S. Hwy 93 Las Vegas, NV

I hereby acknowledge receipt of the above described materials

Name (Print or Type)

Signature

Date Received

Deirdre Jordan

Deirdre Jordan

10-8-10

81 Environmental Tech
13550 N Highway 93
Las Vegas, NV 89165

Ticket Type: INBOUND INVOICE

Ticket Number: 2100
Date: 10/08/2010
Time In: 8:53 am
Time Out: 9:29 am

Customer: 001011 - NGE, LLC c/o Northgate Environ Mgmt

Vehicle/Container: 41589A
Contract: Northgate Env. On Site Soils 3825 1/
Comment: 3825 10 11244

Gross Weight: 128,900 LB Manual In
Tare Weight: 68,600 LB Manual Out
Net Weight: 60300 LB
Net Tons: 30.15

BOL: 12184

Origin	Yards	Material	Billing Quantity
Not Applicable	0.00 YD	SW CONTAMINATED SOIL	30.15 TN

Driver:

RAMON

Weighmaster:

J.M.

IN - GUILFDE OUT - MORENOJ

Indemnification. Customer agrees, by signature above, to indemnify, hold harmless, and defend Republic Services, Inc., its subsidiaries, affiliates, employees, officers and directors from and against any and all liabilities, claims, penalties, forfeitures, suits and the costs and expenses incident thereto, including costs of defense, settlement, and reasonable attorney's fees, which may be incurred, as a result of death or injuries to any person, or damage to any property, contamination of or adverse effects on the environment, caused in whole or in part by the Customer, its employees, or subcontractors in disposing waste at this Facility. In the event Customer delivers Unacceptable Waste (as determined by Republic) Customer agrees to assume all expenses and obligations with the removal and/or resolution of any effects caused by the delivery of such Unacceptable Waste.

Indemnización. Cliente acuerda indemnizar, mantener inmune, y defender Republic Services, Inc., sus subsidiarios, companias, divisiones, empleados, oficiales y directores contra de cualquiera y de todas responsabilidades, demandas, penas, pérdidas, juicios, pleitos y los costos incidente además, incluyendo costos de defensa, de acuerdo judicial, y de honorarios razonables del abogado, que pueden ser incurridos en, o como resultado de, la muerte o herida personal a cualquier persona, o daños a cualquier característica, propiedad, contaminación de la tierra o efectos ilicitos en esta Facilidad, causado entero o en parte por el cliente, sus empleados, o sus subcontratistas en botar basura en esta Facilidad. En el caso que el Cliente entrega, bota, basura (según lo determinado por Republic) en este Establecimiento basura inaceptable en los reglamentos de este Establecimiento, el Cliente se compromete asumir todos los costos y obligaciones con el retiro y/o la resolución de cualquier dano(s) causado por la entrega de tal basura inaceptable.



NON-HAZARDOUS WASTE MANIFEST

MANIFEST # 12184

GENERATOR INFORMATION

Generator Name: Tronox LLC
Address: P.O. Box 55
City: Henderson County: Clark
State: NV Zip: 89009
Site Location (if different): 560 W. Lake Mead
Henderson, NV 89015 (702) 592-7727

CUSTOMER/BILLING INFORMATION

Billing Name: NGE LLC c/o Northgate Environment Management
Address: 300 Frank Ogawa Plaza, Ste 510
City: Oakland County: Alameda
State: CA Zip: 94612

Table with 5 columns: Republic Services Approval #, Description of Waste, Volume/Weight, Expiration Date, Container Type. Row 1: 38251011244, Soil for disposal, 30.15g, 12-31-2011, Tractor with Dump Trailer(s)

*Attach Additional Sheet if necessary

I hereby certify that the above-described materials are non-hazardous wastes as defined by 40 CFR 261 or any applicable state law. Further, that the above named materials are properly classified, described, packaged, marked and labeled, and are in proper condition for transportation according to the applicable regulations of the Department of Transportation.

Susan Crowley
Generator/Authorized Agent Name Signature Date Shipped

TRANSPORTER INFORMATION

Transporter Name: Las Vegas Paving DOT # 191949
Address: 4420 S. Decatur Truck Number:
Las Vegas, NV 89103 Phone Number: (702) 353-4355

I certify no hazardous waste or other regulated substance was knowingly introduced to the waste while in my custody. The waste transported in this vehicle is the waste identified above, to the best of my knowledge.

Name of Authorized Agent Signature Date Delivered 10-8-10

DISPOSAL SITE INFORMATION

Site Name: Apex Regional Landfill Phone No. (702) 599-5920
Address: 13550 U.S. Hwy 93 Las Vegas, NV

I hereby acknowledge receipt of the above described materials
Name (Print or Type) Signature Date Received 10-8-10

81 Environmental Tech
13550 N Highway 93
Las Vegas, NV 89165

Ticket Type: INBOUND INVOICE

Ticket Number: 2101
Date: 10/08/2010
Time In: 8:55 am
Time Out: 9:33 am

Customer: 001011 - NGE, LLC c/o Northgate Environ Mgmt

Vehicle/Container: 29573A
Contract: Northgate Env. On Site Soils 3825 11
Comment: 38251011244

Gross Weight: 127,900 LB Manual In
Tare Weight: 53,220 LB Manual Out
Net Weight: 74680 LB
Net Tons: 37.34

BOL: 12186

Origin	Yards	Material	Billing	Quantity
Not Applicable	0.00 YD	SW CONTAMINATED SOIL	37.34	TN

Driver: 

Weighmaster: 

IN - GUILFDE OUT - MORENOJ

Indemnification. Customer agrees, by signature above, to indemnify, hold harmless, and defend Republic Services, Inc., its subsidiaries, affiliates, employees, officers and directors from and against any and all liabilities, claims, penalties, forfeitures, suits and the costs and expenses incident thereto, including costs of defense, settlement, and reasonable attorney's fees, which may be incurred, as a result of death or injuries to any person, or damage to any property, contamination of or adverse effects on the environment, caused in whole or in part by the Customer, its employees, or subcontractors in disposing waste at this Facility. In the event Customer delivers Unacceptable Waste (as determined by Republic) Customer agrees to assume all expenses and obligations with the removal and/or resolution of any effects caused by the delivery of such Unacceptable Waste.

Indemnización. Cliente acuerda indemnizar, mantener inmune, y defender Republic Services, Inc., sus subsidiarios, compañías, divisiones, empleados, oficiales y directores contra de cualquiera y de todas responsabilidades, demandas, penas, pérdidas, juicios, pleitos y los costos incidente además, incluyendo costos de defensa, de acuerdo judicial, y de honorarios razonables del abogado, que pueden ser incurridos en, o como resultado de, la muerte o herida personal a cualquier persona, o daños a cualquier característica, propiedad, contaminación de la tierra o efectos ilícitos en esta Facilidad, causado entero o en parte por el cliente, sus empleados, o sus subcontratistas en botar basura en esta Facilidad. En el caso que el Cliente entrega, bota, basura (según lo determinado por Republic) en este Establecimiento basura inaceptable en los reglamentos de este Establecimiento, el Cliente se compromete asumir todos los costos y obligaciones con el retiro y/o la resolución de cualquier dano(s) causado por la entrega de tal basura inaceptable.



NON-HAZARDOUS WASTE MANIFEST

MANIFEST # 12186

GENERATOR INFORMATION

Generator Name: Tronox LLC

Address: P.O. Box 55

City: Henderson County: Clark

State: NV Zip: 89009

Site Location (if different): 560 W. Lake Mead

Henderson, NV 89015 (702) 592-7727

CUSTOMER/BILLING INFORMATION

Billing Name: NGE LLC c/o Northgate Environment Management

Address: 300 Frank Ogawa Plaza, Ste 510

City: Oakland County: Alameda

State: CA Zip: 94612

Republic Services Approval #	Description of Waste	Volume/Weight	Expiration Date	Container Type
38251011244	Soil for disposal		12-31-2011	Tractor with Dump Trailer(s)
	RZ- _____ # _____	37.34		

*Attach Additional Sheet if necessary

I hereby certify that the above-described materials are non-hazardous wastes as defined by 40 CFR 261 or any applicable state law. Further, that the above named materials are properly classified, described, packaged, marked and labeled, and are in proper condition for transportation according to the applicable regulations of the Department of Transportation.

Susan Crowley (Signature) Generator/Authorized Agent Name Date Shipped

TRANSPORTER INFORMATION

Transporter Name: Las Vegas Paving DOT # 191949

Address: 4420 S. Decatur Truck Number:

Las Vegas, NV 89103 Phone Number: (702) 353-4355

I certify no hazardous waste or other regulated substance was knowingly introduced to the waste while in my custody. The waste transported in this vehicle is the waste identified above, to the best of my knowledge.

Rigo Bocan (Signature) Name of Authorized Agent Date Delivered 10-8-10

DISPOSAL SITE INFORMATION

Site Name: Apex Regional Landfill Phone No. (702) 599-5920

Address: 13550 U.S. Hwy 93 Las Vegas, NV

Blair Jordan (Signature) Name (Print or Type) Date Received 10-8-10

81 Environmental Tech
13550 N Highway 93
Las Vegas, NV 89165

Ticket Type: INBOUND INVOICE

Ticket Number: 2102
Date: 10/08/2010
Time In: 9:00 am
Time Out: 9:35 am

Customer: 001011 - NGE, LLC c/o Northgate Environ Mgmt

Vehicle/Container: Z009877

Gross Weight: 126,520 LB Manual In
Tare Weight: 49,000 LB Manual Out
Net Weight: 77520 LB
Net Tons: 38.76

Contract: Northgate Env. On Site Soils 3825 11
Comment: ~~2010~~ 3825-10-11244

BOL: 12188

Origin	Yards	Material	Billing Quantity
Not Applicable	0.00 YD	SW CONTAMINATED SOIL	38.76 TN

Driver: _____

Weighmaster: _____

IN - GUILFDE OUT - MORENOJ

Indemnification. Customer agrees, by signature above, to indemnify, hold harmless, and defend Republic Services, Inc., its subsidiaries, affiliates, employees, officers and directors from and against any and all liabilities, claims, penalties, forfeitures, suits and the costs and expenses incident thereto, including costs of defense, settlement, and reasonable attorney's fees, which may be incurred, as a result of death or injuries to any person, or damage to any property, contamination of or adverse effects on the environment, caused in whole or in part by the Customer, its employees, or subcontractors in disposing waste at this Facility. In the event Customer delivers Unacceptable Waste (as determined by Republic) Customer agrees to assume all expenses and obligations with the removal and/or resolution of any effects caused by the delivery of such Unacceptable Waste.

Indemnización. Cliente acuerda indemnizar, mantener inmune, y defender Republic Services, Inc., sus subsidiarios, compañías, divisiones, empleados, oficiales y directores contra de cualquiera y de todas responsabilidades, demandas, penas, pérdidas, juicios, pleitos y los costos incidente además, incluyendo costos de defensa, de acuerdo judicial, y de honorarios razonables del abogado, que pueden ser incurridos en, o como resultado de, la muerte o herida personal a cualquier persona, o daños a cualquier característica, propiedad, contaminación de la tierra o efectos ilícitos en esta Facilidad, causado entero o en parte por el cliente, sus empleados, o sus subcontratistas en botar basura en esta Facilidad. En el caso que el Cliente entrega, bota, basura (según lo determinado por Republic) en este Establecimiento basura inaceptable en los reglamentos de este Establecimiento, el Cliente se compromete asumir todos los costos y obligaciones con el retiro y/o la resolución de cualquier dano(s) causado por la entrega de tal basura inaceptable.



NON-HAZARDOUS WASTE MANIFEST

MANIFEST # 12188

GENERATOR INFORMATION

Generator Name: Tronox LLC

Address: P.O. Box 55

City: Henderson County: Clark

State: NV Zip: 89009

Site Location (if different): 560 W. Lake Mead

Henderson, NV 89015 (702) 592-7727

CUSTOMER/BILLING INFORMATION

Billing Name: NGE LLC c/o Northgate Environment Management

Address: 300 Frank Ogawa Plaza, Ste 510

City: Oakland County: Alameda

State: CA Zip: 94612

Republic Services Approval #	Description of Waste	Volume/Weight	Expiration Date	Container Type
38251011244	Soil for disposal		12-31-2011	Tractor with Dump Trailer(s)
	RZ- _____ # _____	38.76		

*Attach Additional Sheet if necessary

I hereby certify that the above-described materials are non-hazardous wastes as defined by 40 CFR 261 or any applicable state law. Further, that the above named materials are properly classified, described, packaged, marked and labeled, and are in proper condition for transportation according to the applicable regulations of the Department of Transportation.

Susan Crowley
Generator/Authorized Agent Name

Susan Crowley
Signature

Date Shipped

TRANSPORTER INFORMATION

Transporter Name: Las Vegas Paving

DOT # 191949

Address: 4420 S. Decatur

Truck Number: _____

Las Vegas, NV 89103

Phone Number: (702) 353-4355

I certify no hazardous waste or other regulated substance was knowingly introduced to the waste while in my custody. The waste transported in this vehicle is the waste identified above, to the best of my knowledge.

Name of Authorized Agent

[Signature]
Signature

10-8-10
Date Delivered

DISPOSAL SITE INFORMATION

Site Name: Apex Regional Landfill

Phone No. (702) 599-5920

Address: 13550 U.S. Hwy 93 Las Vegas, NV

I hereby acknowledge receipt of the above described materials

Debra [Signature]
Name (Print or Type)

[Signature]
Signature

10-8-10
Date Received

81 Environmental Tech
13550 N Highway 93
Las Vegas, NV 89165

Ticket Type: INBOUND INVOICE

Ticket Number: 2103
Date: 10/08/2010
Time In: 8:57 am
Time Out: 9:36 am

Customer: 001011 - NGE, LLC c/o Northgate Environ Mgmt

Vehicle/Container: 44164A

Gross Weight: 128,340 LB Manual In
Tare Weight: 56,180 LB Manual Out
Net Weight: 72160 LB
Net Tons: 36.08

Contract: Northgate Env. On Site Soils 3825 11
Comment: ~~7006~~ 3825-10-11244

BOL: 12185

Origin	Yards	Material	Billing	Quantity
Not Applicable	0.00 YD	SW CONTAMINATED SOIL	36.08	TN

Driver: 

Weighmaster: 

IN - GUILFDE OUT - MORENOJ

Indemnification. Customer agrees, by signature above, to indemnify, hold harmless, and defend Republic Services, Inc., its subsidiaries, affiliates, employees, officers and directors from and against any and all liabilities, claims, penalties, forfeitures, suits and the costs and expenses incident thereto, including costs of defense, settlement, and reasonable attorney's fees, which may be incurred, as a result of death or injuries to any person, or damage to any property, contamination of or adverse effects on the environment, caused in whole or in part by the Customer, its employees, or subcontractors in disposing waste at this Facility. In the event Customer delivers Unacceptable Waste (as determined by Republic) Customer agrees to assume all expenses and obligations with the removal and/or resolution of any effects caused by the delivery of such Unacceptable Waste.

Indemnización. Cliente acuerda indemnizar, mantener inmune, y defender Republic Services, Inc., sus subsidiarios, compañías, divisiones, empleados, oficiales y directores contra de cualquiera y de todas responsabilidades, demandas, penas, pérdidas, juicios, pleitos y los costos incidente además, incluyendo costos de defensa, de acuerdo judicial, y de honorarios razonables del abogado, que pueden ser incurridos en, o como resultado de, la muerte o herida personal a cualquier persona, o daños a cualquier característica, propiedad, contaminación de la tierra o efectos ilícitos en esta Facilidad, causado entero o en parte por el cliente, sus empleados, o sus subcontratistas en botar basura en esta Facilidad. En el caso que el Cliente entrega, bota, basura (según lo determinado por Republic) en este Establecimiento basura inaceptable en los reglamentos de este Establecimiento, el Cliente se compromete asumir todos los costos y obligaciones con el retiro y/o la resolución de cualquier dano(s) causado por la entrega de tal basura inaceptable.



NON-HAZARDOUS WASTE MANIFEST

MANIFEST # 12185

GENERATOR INFORMATION

Generator Name: Tronox LLC

Address: P.O. Box 55

City: Henderson County: Clark

State: NV Zip: 89009

Site Location (if different): 560 W. Lake Mead

Henderson, NV 89015 (702) 592-7727

CUSTOMER/BILLING INFORMATION

Billing Name: NGE LLC c/o Northgate Environment Management

Address: 300 Frank Ogawa Plaza, Ste 510

City: Oakland County: Alameda

State: CA Zip: 94612

Republic Services Approval #	Description of Waste	Volume/Weight	Expiration Date	Container Type
38251011244	Soil for disposal	36.08	12-31-2011	Tractor with Dump Trailer(s)
	RZ- _____ # _____			

*Attach Additional Sheet if necessary

I hereby certify that the above-described materials are non-hazardous wastes as defined by 40 CFR 261 or any applicable state law. Further, that the above named materials are properly classified, described, packaged, marked and labeled, and are in proper condition for transportation according to the applicable regulations of the Department of Transportation.

Susan Crowley
Generator/Authorized Agent Name

Susan Crowley
Signature

Date Shipped

TRANSPORTER INFORMATION

Transporter Name: Las Vegas Paving

DOT # 191949

Address: 4420 S. Decatur

Truck Number: K-006

Las Vegas, NV 89103

Phone Number: (702) 353-4355

I certify no hazardous waste or other regulated substance was knowingly introduced to the waste while in my custody. The waste transported in this vehicle is the waste identified above, to the best of my knowledge.

Brian Mulvey
Name of Authorized Agent

Brian Mulvey
Signature

10-8-10
Date Delivered

DISPOSAL SITE INFORMATION

Site Name: Apex Regional Landfill

Phone No. (702) 599-5920

Address: 13550 U.S. Hwy 93 Las Vegas, NV

I hereby acknowledge receipt of the above described materials

Beth Jordan
Name (Print or Type)

Beth Jordan
Signature

10-8-10
Date Received

81 Environmental Tech
13550 N Highway 93
Las Vegas, NV 89165

Ticket Type: INBOUND INVOICE

Ticket Number: 2104
Date: 10/08/2010
Time In: 9:01 am
Time Out: 9:40 am

Customer: 001011 - NGE, LLC c/o Northgate Environ Mgmt

Vehicle/Container: 85914P

Gross Weight: 125,720 LB Manual In
Tare Weight: 53,520 LB Manual Out
Net Weight: 72,200 LB
Net Tons: 36.10

Contract: Northgate Env. On Site Soils 3825 11
Comment: ~~DE7~~ 3825-1011244

BOL: 12187

Origin	Yards	Material	Billing	Quantity
Not Applicable	0.00 YD	SW CONTAMINATED SOIL	36.10	TN

Driver: _____

Weighmaster: _____

IN - GUILFDE OUT - MORENOJ

Indemnification. Customer agrees, by signature above, to indemnify, hold harmless, and defend Republic Services, Inc., its subsidiaries, affiliates, employees, officers and directors from and against any and all liabilities, claims, penalties, forfeitures, suits and the costs and expenses incident thereto, including costs of defense, settlement, and reasonable attorney's fees, which may be incurred, as a result of death or injuries to any person, or damage to any property, contamination of or adverse effects on the environment, caused in whole or in part by the Customer, its employees, or subcontractors in disposing waste at this Facility. In the event Customer delivers Unacceptable Waste (as determined by Republic) Customer agrees to assume all expenses and obligations with the removal and/or resolution of any effects caused by the delivery of such Unacceptable Waste.

Indemnización. Cliente acuerda indemnizar, mantener inmune, y defender Republic Services, Inc., sus subsidiarios, compañías, divisiones, empleados, oficiales y directores contra de cualquiera y de todas responsabilidades, demandas, penas, pérdidas, juicios, pleitos y los costos incidente además, incluyendo costos de defensa, de acuerdo judicial, y de honorarios razonables del abogado, que pueden ser incurridos en, o como resultado de, la muerte o herida personal a cualquier persona, o daños a cualquier característica, propiedad, contaminación de la tierra o efectos ilícitos en esta Facilidad, causado entero o en parte por el cliente, sus empleados, o sus subcontratistas en botar basura en esta Facilidad. En el caso que el Cliente entrega, bota, basura (según lo determinado por Republic) en este Establecimiento basura inaceptable en los reglamentos de este Establecimiento, el Cliente se compromete asumir todos los costos y obligaciones con el retiro y/o la resolución de cualquier dano(s) causado por la entrega de tal basura inaceptable.



NON-HAZARDOUS WASTE MANIFEST

MANIFEST # 12187

GENERATOR INFORMATION

Generator Name: Tronox LLC

Address: P.O. Box 55

City: Henderson County: Clark

State: NV Zip: 89009

Site Location (if different): 560 W. Lake Mead

Henderson, NV 89015 (702) 592-7727

CUSTOMER/BILLING INFORMATION

Billing Name: NGE LLC c/o Northgate Environment Management

Address: 300 Frank Ogawa Plaza, Ste 510

City: Oakland County: Alameda

State: CA Zip: 94612

Republic Services Approval #	Description of Waste	Volume/Weight	Expiration Date	Container Type
38251011244	Soil for disposal		12-31-2011	Tractor with Dump Trailer(s)
	RZ- _____ # _____	36.10		

*Attach Additional Sheet if necessary

I hereby certify that the above-described materials are non-hazardous wastes as defined by 40 CFR 261 or any applicable state law. Further, that the above named materials are properly classified, described, packaged, marked and labeled, and are in proper condition for transportation according to the applicable regulations of the Department of Transportation.

Susan Crowley Tom Crowley
 Generator/Authorized Agent Name Signature Date Shipped

TRANSPORTER INFORMATION

Transporter Name: Las Vegas Paving

DOT # 191949

Address: 4420 S. Decatur

Truck Number: _____

Las Vegas, NV 89103

Phone Number: (702) 353-4355

I certify no hazardous waste or other regulated substance was knowingly introduced to the waste while in my custody. The waste transported in this vehicle is the waste identified above, to the best of my knowledge.

Luis Delcid [Signature] 10-8-10
 Name of Authorized Agent Signature Date Delivered

DISPOSAL SITE INFORMATION

Site Name: Apex Regional Landfill

Phone No. (702) 599-5920

Address: 13550 U.S. Hwy 93 Las Vegas, NV

I hereby acknowledge receipt of the above described materials

Debra Jones [Signature] 10-8-10
 Name (Print or Type) Signature Date Received



NON-HAZARDOUS WASTE MANIFEST

MANIFEST # 12189

GENERATOR INFORMATION

Generator Name: Tronox LLC
Address: P.O. Box 55
City: Henderson County: Clark
State: NV Zip: 89009
Site Location (if different): 560 W. Lake Mead
Henderson, NV 89015 (702) 592-7727

CUSTOMER/BILLING INFORMATION

Billing Name: NGE LLC c/o Northgate Environment Management
Address: 300 Frank Ogawa Plaza, Ste 510
City: Oakland County: Alameda
State: CA Zip: 94612

Table with 5 columns: Republic Services Approval #, Description of Waste, Volume/Weight, Expiration Date, Container Type. Row 1: 38251011244, Soil for disposal, 35.13, 12-31-2011, Tractor with Dump Trailer(s).

*Attach Additional Sheet if necessary

I hereby certify that the above-described materials are non-hazardous wastes as defined by 40 CFR 261 or any applicable state law. Further, that the above named materials are properly classified, described, packaged, marked and labeled, and are in proper condition for transportation according to the applicable regulations of the Department of Transportation.

Susan Crowley
Generator/Authorized Agent Name Signature Date Shipped

TRANSPORTER INFORMATION

Transporter Name: Las Vegas Paving DOT # 191949
Address: 4420 S. Decatur Truck Number:
Las Vegas, NV 89103 Phone Number: (702) 353-4355

I certify no hazardous waste or other regulated substance was knowingly introduced to the waste while in my custody. The waste transported in this vehicle is the waste identified above, to the best of my knowledge.

Name of Authorized Agent Signature Date Delivered 10-8-10

DISPOSAL SITE INFORMATION

Site Name: Apex Regional Landfill Phone No. (702) 599-5920
Address: 13550 U.S. Hwy 93 Las Vegas, NV

I hereby acknowledge receipt of the above described materials
Name (Print or Type) Signature Date Received 10-8-10

81 Environmental Tech
13550 N Highway 93
Las Vegas, NV 89165

Ticket Type: INBOUND INVOICE

Ticket Number: 2106
Date: 10/08/2010
Time In: 9:26 am
Time Out: 9:50 am

Customer: 001011 - NGE, LLC c/o Northgate Environ Mgmt

Vehicle/Container: 192391

Contract: Northgate Env. On Site Soils 3825 11
Comment: 3825-10-11244

Gross Weight: 94,080 LB Manual In
Tare Weight: 39,880 LB Manual Out
Net Weight: 54200 LB
Net Tons: 27.10

BOL: 12192

Origin	Yards	Material	Billing	Quantity
Not Applicable	0.00 YD	SW CONTAMINATED SOIL	27.10	TN

Driver: _____

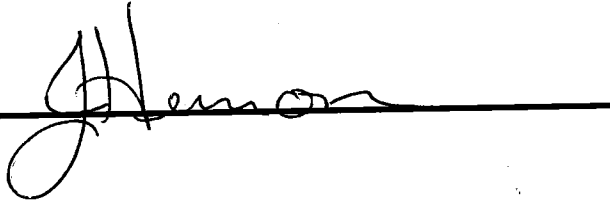

Weighmaster: _____



IN - GUILFDE OUT - MORENOJ

Indemnification. Customer agrees, by signature above, to indemnify, hold harmless, and defend Republic Services, Inc., its subsidiaries, affiliates, employees, officers and directors from and against any and all liabilities, claims, penalties, forfeitures, suits and the costs and expenses incident thereto, including costs of defense, settlement, and reasonable attorney's fees, which may be incurred, as a result of death or injuries to any person, or damage to any property, contamination of or adverse effects on the environment, caused in whole or in part by the Customer, its employees, or subcontractors in disposing waste at this Facility. In the event Customer delivers Unacceptable Waste (as determined by Republic) Customer agrees to assume all expenses and obligations with the removal and/or resolution of any effects caused by the delivery of such Unacceptable Waste.

Indemnización. Cliente acuerda indemnizar, mantener inmune, y defender Republic Services, Inc., sus subsidiarios, compañías, divisiones, empleados, oficiales y directores contra de cualquiera y de todas responsabilidades, demandas, penas, pérdidas, juicios, pleitos y los costos incidente además, incluyendo costos de defensa, de acuerdo judicial, y de honorarios razonables del abogado, que pueden ser incurridos en, o como resultado de, la muerte o herida personal a cualquier persona, o daños a cualquier característica, propiedad, contaminación de la tierra o efectos ilícitos en esta Facilidad, causado entero o en parte por el cliente, sus empleados, o sus subcontratistas en botar basura en esta Facilidad. En el caso que el Cliente entrega, bota, basura (según lo determinado por Republic) en este Establecimiento basura inaceptable en los reglamentos de este Establecimiento, el Cliente se compromete asumir todos los costos y obligaciones con el retiro y/o la resolución de cualquier dano(s) causado por la entrega de tal basura inaceptable.



NON-HAZARDOUS WASTE MANIFEST

MANIFEST # 12192

GENERATOR INFORMATION

Generator Name: Tronox LLC
Address: P.O. Box 55
City: Henderson County: Clark
State: NV Zip: 89009
Site Location (if different): 560 W. Lake Mead
Henderson, NV 89015 (702) 592-7727

CUSTOMER/BILLING INFORMATION

Billing Name: NGE LLC c/o Northgate Environment Management
Address: 300 Frank Ogawa Plaza, Ste 510
City: Oakland County: Alameda
State: CA Zip: 94612

Table with 5 columns: Republic Services Approval #, Description of Waste, Volume/Weight, Expiration Date, Container Type. Row 1: 38251011244, Soil for disposal, 27.10, 12-31-2011, Tractor with Dump Trailer(s).

*Attach Additional Sheet if necessary

I hereby certify that the above-described materials are non-hazardous wastes as defined by 40 CFR 261 or any applicable state law. Further, that the above named materials are properly classified, described, packaged, marked and labeled, and are in proper condition for transportation according to the applicable regulations of the Department of Transportation.

Susan Crowley (Signature)
Generator/Authorized Agent Name Signature Date Shipped

TRANSPORTER INFORMATION

Transporter Name: Las Vegas Paving DOT # 191949
Address: 4420 S. Decatur Truck Number:
Las Vegas, NV 89103 Phone Number: (702) 353-4355

I certify no hazardous waste or other regulated substance was knowingly introduced to the waste while in my custody. The waste transported in this vehicle is the waste identified above, to the best of my knowledge.

(Signature)
Name of Authorized Agent Signature Date Delivered 10-8-10

DISPOSAL SITE INFORMATION

Site Name: Apex Regional Landfill Phone No. (702) 599-5920
Address: 13550 U.S. Hwy 93 Las Vegas, NV

I hereby acknowledge receipt of the above described materials
(Olga Jovet) (Signature)
Name (Print or Type) Signature Date Received 10-8-10

81 Environmental Tech
13550 N Highway 93
Las Vegas, NV 89165

Ticket Type: INBOUND INVOICE

Ticket Number: 2107
Date: 10/08/2010
Time In: 9:35 am
Time Out: 10:03 am

Customer: 001011 - NGE, LLC c/o Northgate Environ Mgmt

Vehicle/Container: 80812P
Contract: Northgate Env. On Site Soils 3825 1I
3825-10-1244

Gross Weight: 123,840 LB Manual In
Tare Weight: 56,580 LB Manual Out
Net Weight: 67,260 LB
Net Tons: 33.63

BOL: 12190

Origin	Yards	Material	Billing	Quantity
Not Applicable	0.00 YD	SW CONTAMINATED SOIL	33.63	TN

Driver: 

Weighmaster: 

IN - GUILFDE OUT - MORENOJ

Indemnification. Customer agrees, by signature above, to indemnify, hold harmless, and defend Republic Services, Inc., its subsidiaries, affiliates, employees, officers and directors from and against any and all liabilities, claims, penalties, forfeitures, suits and the costs and expenses incident thereto, including costs of defense, settlement, and reasonable attorney's fees, which may be incurred, as a result of death or injuries to any person, or damage to any property, contamination of or adverse effects on the environment, caused in whole or in part by the Customer, its employees, or subcontractors in disposing waste at this Facility. In the event Customer delivers Unacceptable Waste (as determined by Republic) Customer agrees to assume all expenses and obligations with the removal and/or resolution of any effects caused by the delivery of such Unacceptable Waste.

Indemnización. Cliente acuerda indemnizar, mantener inmune, y defender Republic Services, Inc., sus subsidiarios, compañías, divisiones, empleados, oficiales y directores contra de cualquiera y de todas responsabilidades, demandas, penas, pérdidas, juicios, pleitos y los costos incidente además, incluyendo costos de defensa, de acuerdo judicial, y de honorarios razonables del abogado, que pueden ser incurridos en, o como resultado de, la muerte o herida personal a cualquier persona, o daños a cualquier característica, propiedad, contaminación de la tierra o efectos ilícitos en esta Facilidad, causado entero o en parte por el cliente, sus empleados, o sus subcontratistas en botar basura en esta Facilidad. En el caso que el Cliente entrega, bota, basura (según lo determinado por Republic) en este Establecimiento basura inaceptable en los reglamentos de este Establecimiento, el Cliente se compromete asumir todos los costos y obligaciones con el retiro y/o la resolución de cualquier dano(s) causado por la entrega de tal basura inaceptable.



NON-HAZARDOUS WASTE MANIFEST

MANIFEST # 12190

GENERATOR INFORMATION

Generator Name: Tronox LLC
Address: P.O. Box 55
City: Henderson County: Clark
State: NV Zip: 89009
Site Location (if different): 560 W. Lake Mead
Henderson, NV 89015 (702) 592-7727

CUSTOMER/BILLING INFORMATION

Billing Name: NGE LLC c/o Northgate Environment Management
Address: 300 Frank Ogawa Plaza, Ste 510
City: Oakland County: Alameda
State: CA Zip: 94612

Table with 5 columns: Republic Services Approval #, Description of Waste, Volume/Weight, Expiration Date, Container Type. Row 1: 38251011244, Soil for disposal, 33.63, 12-31-2011, Tractor with Dump Trailer(s).

*Attach Additional Sheet if necessary

I hereby certify that the above-described materials are non-hazardous wastes as defined by 40 CFR 261 or any applicable state law. Further, that the above named materials are properly classified, described, packaged, marked and labeled, and are in proper condition for transportation according to the applicable regulations of the Department of Transportation.

Susan Crowley
Generator/Authorized Agent Name Signature Date Shipped

TRANSPORTER INFORMATION

Transporter Name: Las Vegas Paving DOT # 191949
Address: 4420 S. Decatur Truck Number:
Las Vegas, NV 89103 Phone Number: (702) 353-4355

I certify no hazardous waste or other regulated substance was knowingly introduced to the waste while in my custody. The waste transported in this vehicle is the waste identified above, to the best of my knowledge.

Name of Authorized Agent Signature Date Delivered 10-8-10

DISPOSAL SITE INFORMATION

Site Name: Apex Regional Landfill Phone No. (702) 599-5920
Address: 13550 U.S. Hwy 93 Las Vegas, NV

I hereby acknowledge receipt of the above described materials
Beckie Sord Signature Date Received 10-8-10

81 Environmental Tech
13550 N Highway 93
Las Vegas, NV 89165

Ticket Type: INBOUND INVOICE

Ticket Number: 2108
Date: 10/08/2010
Time In: 9:36 am
Time Out: 10:04 am

Customer: 001011 - NGE, LLC c/o Northgate Environ Mgmt

Vehicle/Container: 27010P

Gross Weight: 106,940 LB Manual In
Tare Weight: 52,900 LB Manual Out
Net Weight: 54040 LB
Net Tons: 27.02

Contract: Northgate Env. On Site Soils 3825 11
Comment: 973825-10-11244

BOL: 12191

Origin	Yards	Material	Billing Quantity
Not Applicable	0.00 YD	SW CONTAMINATED SOIL	27.02 TN

Driver: _____

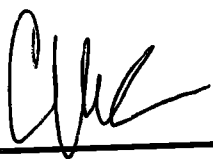

Weighmaster: _____



IN - GUILFDE OUT - MORENOJ

Indemnification. Customer agrees, by signature above, to indemnify, hold harmless, and defend Republic Services, Inc., its subsidiaries, affiliates, employees, officers and directors from and against any and all liabilities, claims, penalties, forfeitures, suits and the costs and expenses incident thereto, including costs of defense, settlement, and reasonable attorney's fees, which may be incurred, as a result of death or injuries to any person, or damage to any property, contamination of or adverse effects on the environment, caused in whole or in part by the Customer, its employees, or subcontractors in disposing waste at this Facility. In the event Customer delivers Unacceptable Waste (as determined by Republic) Customer agrees to assume all expenses and obligations with the removal and/or resolution of any effects caused by the delivery of such Unacceptable Waste.

Indemnización. Cliente acuerda indemnizar, mantener inmune, y defender Republic Services, Inc., sus subsidiarios, compañías, divisiones, empleados, oficiales y directores contra de cualquiera y de todas responsabilidades, demandas, penas, pérdidas, juicios, pleitos y los costos incidente además, incluyendo costos de defensa, de acuerdo judicial, y de honorarios razonables del abogado, que pueden ser incurridos en, o como resultado de, la muerte o herida personal a cualquier persona, o daños a cualquier característica, propiedad, contaminación de la tierra o efectos ilícitos en esta Facilidad, causado entero o en parte por el cliente, sus empleados, o sus subcontratistas en botar basura en esta Facilidad. En el caso que el Cliente entrega, bota, basura (según lo determinado por Republic) en este Establecimiento basura inaceptable en los reglamentos de este Establecimiento, el Cliente se compromete asumir todos los costos y obligaciones con el retiro y/o la resolución de cualquier dano(s) causado por la entrega de tal basura inaceptable.



NON-HAZARDOUS WASTE MANIFEST

MANIFEST # 12191

GENERATOR INFORMATION

Generator Name: Tronox LLC
Address: P.O. Box 55
City: Henderson County: Clark
State: NV Zip: 89009
Site Location (if different): 560 W. Lake Mead
Henderson, NV 89015 (702) 592-7727

CUSTOMER/BILLING INFORMATION

Billing Name: NGE LLC c/o Northgate Environment Management
Address: 300 Frank Ogawa Plaza, Ste 510
City: Oakland County: Alameda
State: CA Zip: 94612

Table with 5 columns: Republic Services Approval #, Description of Waste, Volume/Weight, Expiration Date, Container Type. Row 1: 38251011244, Soil for disposal, 27.02, 12-31-2011, Tractor with Dump Trailer(s).

*Attach Additional Sheet if necessary

I hereby certify that the above-described materials are non-hazardous wastes as defined by 40 CFR 261 or any applicable state law. Further, that the above named materials are properly classified, described, packaged, marked and labeled, and are in proper condition for transportation according to the applicable regulations of the Department of Transportation.

Susan Crowley
Generator/Authorized Agent Name Signature Date Shipped

TRANSPORTER INFORMATION

Transporter Name: Las Vegas Paving DOT # 191949
Address: 4420 S. Decatur Truck Number:
Las Vegas, NV 89103 Phone Number: (702) 353-4355

I certify no hazardous waste or other regulated substance was knowingly introduced to the waste while in my custody. The waste transported in this vehicle is the waste identified above, to the best of my knowledge.

Name of Authorized Agent Signature Date Delivered 10-8-10

DISPOSAL SITE INFORMATION

Site Name: Apex Regional Landfill Phone No. (702) 599-5920
Address: 13550 U.S. Hwy 93 Las Vegas, NV

I hereby acknowledge receipt of the above described materials
Name (Print or Type) Signature Date Received 10-8-10

81 Environmental Tech
13550 N Highway 93
Las Vegas, NV 89165

Ticket Type: INBOUND INVOICE

Ticket Number: 2109
Date: 10/08/2010
Time In: 9:37 am
Time Out: 10:06 am

Customer: 001011 - NGE, LLC c/o Northgate Environ Mgmt

Vehicle/Container: 85887P

Gross Weight: 131,480 LB Manual In
Tare Weight: 51,060 LB Manual Out
Net Weight: 80420 LB
Net Tons: 40.21

Contract: Northgate Env. On Site Soils 3825 11

Comment: ~~ROI 382510-11249~~

BOL: 12193

Origin	Yards	Material	Billing Quantity
Not Applicable	0.00 YD	SW CONTAMINATED SOIL	40.21 TN

Driver: Miguel Ramos

Weighmaster: OS

IN - GUILFDE OUT - MORENOJ

Indemnification. Customer agrees, by signature above, to indemnify, hold harmless, and defend Republic Services, Inc., its subsidiaries, affiliates, employees, officers and directors from and against any and all liabilities, claims, penalties, forfeitures, suits and the costs and expenses incident thereto, including costs of defense, settlement, and reasonable attorney's fees, which may be incurred, as a result of death or injuries to any person, or damage to any property, contamination of or adverse effects on the environment, caused in whole or in part by the Customer, its employees, or subcontractors in disposing waste at this Facility. In the event Customer delivers Unacceptable Waste (as determined by Republic) Customer agrees to assume all expenses and obligations with the removal and/or resolution of any effects caused by the delivery of such Unacceptable Waste.

Indemnización. Cliente acuerda indemnizar, mantener inmune, y defender Republic Services, Inc., sus subsidiarios, compañías, divisiones, empleados, oficiales y directores contra de cualquiera y de todas responsabilidades, demandas, penas, pérdidas, juicios, pleitos y los costos incidente además, incluyendo costos de defensa, de acuerdo judicial, y de honorarios razonables del abogado, que pueden ser incurridos en, o como resultado de, la muerte o herida personal a cualquier persona, o daños a cualquier característica, propiedad, contaminación de la tierra o efectos ilícitos en esta Facilidad, causado entero o en parte por el cliente, sus empleados, o sus subcontratistas en botar basura en esta Facilidad. En el caso que el Cliente entrega, bota, basura (según lo determinado por Republic) en este Establecimiento basura inaceptable en los reglamentos de este Establecimiento, el Cliente se compromete asumir todos los costos y obligaciones con el retiro y/o la resolución de cualquier dano(s) causado por la entrega de tal basura inaceptable.



NON-HAZARDOUS WASTE MANIFEST

MANIFEST # 12193

GENERATOR INFORMATION

Generator Name: Tronox LLC

Address: P.O. Box 55

City: Henderson County: Clark

State: NV Zip: 89009

Site Location (if different): 560 W. Lake Mead

Henderson, NV 89015 (702) 592-7727

CUSTOMER/BILLING INFORMATION

Billing Name: NGE LLC c/o Northgate Environment Management

Address: 300 Frank Ogawa Plaza, Ste 510

City: Oakland County: Alameda

State: CA Zip: 94612

Republic Services Approval #	Description of Waste	Volume/Weight	Expiration Date	Container Type
38251011244	Soil for disposal		12-31-2011	Tractor with Dump Trailer(s)
	RZ- _____ # _____	40.21		

*Attach Additional Sheet if necessary

I hereby certify that the above-described materials are non-hazardous wastes as defined by 40 CFR 261 or any applicable state law. Further, that the above named materials are properly classified, described, packaged, marked and labeled, and are in proper condition for transportation according to the applicable regulations of the Department of Transportation.

Susan Crowley (Signature) Generator/Authorized Agent Name Date Shipped

TRANSPORTER INFORMATION

Transporter Name: Las Vegas Paving

DOT # 191949

Address: 4420 S. Decatur

Truck Number: 201

Las Vegas, NV 89103

Phone Number: (702) 353-4355

I certify no hazardous waste or other regulated substance was knowingly introduced to the waste while in my custody. The waste transported in this vehicle is the waste identified above, to the best of my knowledge.

Miguel Roman (Signature) Name of Authorized Agent Date Delivered 10.8.10

DISPOSAL SITE INFORMATION

Site Name: Apex Regional Landfill

Phone No. (702) 599-5920

Address: 13550 U.S. Hwy 93 Las Vegas, NV

I hereby acknowledge receipt of the above described materials (Signature) Name (Print or Type) Signature Date Received

81 Environmental Tech
13550 N Highway 93
Las Vegas, NV 89165

Ticket Type: INBOUND INVOICE

Ticket Number: 2110
Date: 10/08/2010
Time In: 9:45 am
Time Out: 10:16 am

Customer: 001011 - NGE, LLC c/o Northgate Environ Mgmt

Vehicle/Container: 71893P

Gross Weight: 137,620 LB Manual In
Tare Weight: 53,540 LB Manual Out
Net Weight: 84080 LB
Net Tons: 42.04

Contract: Northgate Env. On Site Soils 3825 11
Comment: 23 8 25-10-11247

BOL: 12194

Origin	Yards	Material	Billing Quantity
Not Applicable	0.00 YD	SW CONTAMINATED SOIL	42.04 TN

Driver: 

Weighmaster: 

IN - GUILFDE OUT - MORENOJ

Indemnification. Customer agrees, by signature above, to indemnify, hold harmless, and defend Republic Services, Inc., its subsidiaries, affiliates, employees, officers and directors from and against any and all liabilities, claims, penalties, forfeitures, suits and the costs and expenses incident thereto, including costs of defense, settlement, and reasonable attorney's fees, which may be incurred, as a result of death or injuries to any person, or damage to any property, contamination of or adverse effects on the environment, caused in whole or in part by the Customer, its employees, or subcontractors in disposing waste at this Facility. In the event Customer delivers Unacceptable Waste (as determined by Republic) Customer agrees to assume all expenses and obligations with the removal and/or resolution of any effects caused by the delivery of such Unacceptable Waste.

Indemnización. Cliente acuerda indemnizar, mantener inmune, y defender Republic Services, Inc., sus subsidiarios, compañías, divisiones, empleados, oficiales y directores contra de cualquiera y de todas responsabilidades, demandas, penas, pérdidas, juicios, pleitos y los costos incidente además, incluyendo costos de defensa, de acuerdo judicial, y de honorarios razonables del abogado, que pueden ser incurridos en, o como resultado de, la muerte o herida personal a cualquier persona, o daños a cualquier característica, propiedad, contaminación de la tierra o efectos ilícitos en esta Facilidad, causado entero o en parte por el cliente, sus empleados, o sus subcontratistas en botar basura en esta Facilidad. En el caso que el Cliente entrega, bota, basura (según lo determinado por Republic) en este Establecimiento basura inaceptable en los reglamentos de este Establecimiento, el Cliente se compromete asumir todos los costos y obligaciones con el retiro y/o la resolución de cualquier dano(s) causado por la entrega de tal basura inaceptable.



NON-HAZARDOUS WASTE MANIFEST

MANIFEST # 12194

GENERATOR INFORMATION

Generator Name: Tronox LLC
Address: P.O. Box 55
City: Henderson County: Clark
State: NV Zip: 89009
Site Location (if different): 560 W. Lake Mead
Henderson, NV 89015 (702) 592-7727

CUSTOMER/BILLING INFORMATION

Billing Name: NGE LLC c/o Northgate Environment Management
Address: 300 Frank Ogawa Plaza, Ste 510
City: Oakland County: Alameda
State: CA Zip: 94612

Table with 5 columns: Republic Services Approval #, Description of Waste, Volume/Weight, Expiration Date, Container Type. Row 1: 38251011244, Soil for disposal, 42.04, 12-31-2011, Tractor with Dump Trailer(s).

*Attach Additional Sheet if necessary

I hereby certify that the above-described materials are non-hazardous wastes as defined by 40 CFR 261 or any applicable state law. Further, that the above named materials are properly classified, described, packaged, marked and labeled, and are in proper condition for transportation according to the applicable regulations of the Department of Transportation.

Susan Crowley
Generator/Authorized Agent Name
Signature: [Handwritten Signature]
Date Shipped

TRANSPORTER INFORMATION

Transporter Name: Las Vegas Paving DOT # 191949
Address: 4420 S. Decatur Truck Number:
Las Vegas, NV 89103 Phone Number: (702) 353-4355

I certify no hazardous waste or other regulated substance was knowingly introduced to the waste while in my custody. The waste transported in this vehicle is the waste identified above, to the best of my knowledge.

Name of Authorized Agent
Signature: [Handwritten Signature]
Date Delivered: 10-8-10

DISPOSAL SITE INFORMATION

Site Name: Apex Regional Landfill Phone No. (702) 599-5920
Address: 13550 U.S. Hwy 93 Las Vegas, NV

I hereby acknowledge receipt of the above described materials
Name (Print or Type): [Handwritten Name]
Signature: [Handwritten Signature]
Date Received: 10-8-10

81 Environmental Tech
13550 N Highway 93
Las Vegas, NV 89165

Ticket Type: INBOUND INVOICE

Ticket Number: 2111
Date: 10/08/2010
Time In: 9:58 am
Time Out: 10:19 am

Customer: 001011 - NGE, LLC c/o Northgate Environ Mgmt

Vehicle/Container: 85156P
Contract: Northgate Env. On Site Soils 3825 11
Comment: ~~JOHN HARDIN PURPLE 44~~
3825-10-11244

Gross Weight: 136,640 LB Manual In
Tare Weight: 57,220 LB Manual Out
Net Weight: 79,420 LB
Net Tons: 39.71

BOL: 12195

Origin	Yards	Material	Billing Quantity
Not Applicable	0.00 YD	SW CONTAMINATED SOIL	39.71 TN

Driver: 

Weighmaster: 

IN - GUILFDE OUT - MORENOJ

Indemnification. Customer agrees, by signature above, to indemnify, hold harmless, and defend Republic Services, Inc., its subsidiaries, affiliates, employees, officers and directors from and against any and all liabilities, claims, penalties, forfeitures, suits and the costs and expenses incident thereto, including costs of defense, settlement, and reasonable attorney's fees, which may be incurred, as a result of death or injuries to any person, or damage to any property, contamination of or adverse effects on the environment, caused in whole or in part by the Customer, its employees, or subcontractors in disposing waste at this Facility. In the event Customer delivers Unacceptable Waste (as determined by Republic) Customer agrees to assume all expenses and obligations with the removal and/or resolution of any effects caused by the delivery of such Unacceptable Waste.

Indemnización. Cliente acuerda indemnizar, mantener inmune, y defender Republic Services, Inc., sus subsidiarios, compañías, divisiones, empleados, oficiales y directores contra de cualquiera y de todas responsabilidades, demandas, penas, pérdidas, juicios, pleitos y los costos incidente además, incluyendo costos de defensa, de acuerdo judicial, y de honorarios razonables del abogado, que pueden ser incurridos en, o como resultado de, la muerte o herida personal a cualquier persona, o daños a cualquier característica, propiedad, contaminación de la tierra o efectos ilícitos en esta Facilidad, causado entero o en parte por el cliente, sus empleados, o sus subcontratistas en botar basura en esta Facilidad. En el caso que el Cliente entrega, bota, basura (según lo determinado por Republic) en este Establecimiento basura inaceptable en los reglamentos de este Establecimiento, el Cliente se compromete asumir todos los costos y obligaciones con el retiro y/o la resolución de cualquier dano(s) causado por la entrega de tal basura inaceptable.



NON-HAZARDOUS WASTE MANIFEST

MANIFEST # 12195

GENERATOR INFORMATION

Generator Name: Tronox LLC

Address: P.O. Box 55

City: Henderson County: Clark

State: NV Zip: 89009

Site Location (if different): 560 W. Lake Mead

Henderson, NV 89015 (702) 592-7727

CUSTOMER/BILLING INFORMATION

Billing Name: NGE LLC c/o Northgate Environment Management

Address: 300 Frank Ogawa Plaza, Ste 510

City: Oakland County: Alameda

State: CA Zip: 94612

Republic Services Approval #	Description of Waste	Volume/Weight	Expiration Date	Container Type
38251011244	Soil for disposal		12-31-2011	Tractor with Dump Trailer(s)
	RZ- _____ # _____	39.75		

*Attach Additional Sheet if necessary

I hereby certify that the above-described materials are non-hazardous wastes as defined by 40 CFR 261 or any applicable state law. Further, that the above named materials are properly classified, described, packaged, marked and labeled, and are in proper condition for transportation according to the applicable regulations of the Department of Transportation.

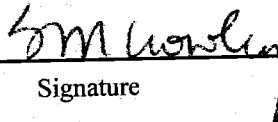
Susan Crowley  _____
 Generator/Authorized Agent Name Signature Date Shipped

TRANSPORTER INFORMATION

Transporter Name: Las Vegas Paving

DOT # 191949

Address: 4420 S. Decatur

Truck Number: _____

Las Vegas, NV 89103

Phone Number: (702) 353-4355

I certify no hazardous waste or other regulated substance was knowingly introduced to the waste while in my custody. The waste transported in this vehicle is the waste identified above, to the best of my knowledge.

 _____
 Name of Authorized Agent Signature Date Delivered 10-8-10

DISPOSAL SITE INFORMATION

Site Name: Apex Regional Landfill

Phone No. (702) 599-5920

Address: 13550 U.S. Hwy 93 Las Vegas, NV

I hereby acknowledge receipt of the above described materials  _____
 Name (Print or Type) Signature Date Received 10-8-10

81 Environmental Tech
13550 N Highway 93
Las Vegas, NV 89165

Ticket Type: INBOUND INVOICE

Ticket Number: 2112
Date: 10/08/2010
Time In: 10:08 am
Time Out: 10:34 am

Customer: 001011 - NGE, LLC c/o Northgate Environ Mgmt

Vehicle/Container: 66954P
Contract: Northgate Env. On Site Soils 3825 11
Comment: 55382510 1144

Gross Weight: 129,660 LB Manual In
Tare Weight: 53,480 LB Manual Out
Net Weight: 76180 LB
Net Tons: 38.09

BOL: 12197

Origin	Yards	Material	Billing	Quantity
Not Applicable	0.00 YD	SW CONTAMINATED SOIL	38.09	TN

Driver: _____

Weighmaster: _____

IN - GUILFDE OUT - MORENOJ

Indemnification. Customer agrees, by signature above, to indemnify, hold harmless, and defend Republic Services, Inc., its subsidiaries, affiliates, employees, officers and directors from and against any and all liabilities, claims, penalties, forfeitures, suits and the costs and expenses incident thereto, including costs of defense, settlement, and reasonable attorney's fees, which may be incurred, as a result of death or injuries to any person, or damage to any property, contamination of or adverse effects on the environment, caused in whole or in part by the Customer, its employees, or subcontractors in disposing waste at this Facility. In the event Customer delivers Unacceptable Waste (as determined by Republic) Customer agrees to assume all expenses and obligations with the removal and/or resolution of any effects caused by the delivery of such Unacceptable Waste.

Indemnización. Cliente acuerda indemnizar, mantener inmune, y defender Republic Services, Inc., sus subsidiarios, compañías, divisiones, empleados, oficiales y directores contra de cualquiera y de todas responsabilidades, demandas, penas, pérdidas, juicios, pleitos y los costos incidente además, incluyendo costos de defensa, de acuerdo judicial, y de honorarios razonables del abogado, que pueden ser incurridos en, o como resultado de, la muerte o herida personal a cualquier persona, o daños a cualquier característica, propiedad, contaminación de la tierra o efectos ilícitos en esta Facilidad, causado entero o en parte por el cliente, sus empleados, o sus subcontratistas en botar basura en esta Facilidad. En el caso que el Cliente entrega, bota, basura (según lo determinado por Republic) en este Establecimiento basura inaceptable en los reglamentos de este Establecimiento, el Cliente se compromete asumir todos los costos y obligaciones con el retiro y/o la resolución de cualquier dano(s) causado por la entrega de tal basura inaceptable.



NON-HAZARDOUS WASTE MANIFEST

MANIFEST # 12197

GENERATOR INFORMATION

Generator Name: Tronox LLC

Address: P.O. Box 55

City: Henderson County: Clark

State: NV Zip: 89009

Site Location (if different): 560 W. Lake Mead

Henderson, NV 89015 (702) 592-7727

CUSTOMER/BILLING INFORMATION

Billing Name: NGE LLC c/o Northgate Environment Management

Address: 300 Frank Ogawa Plaza, Ste 510

City: Oakland County: Alameda

State: CA Zip: 94612

Republic Services Approval #	Description of Waste	Volume/Weight	Expiration Date	Container Type
38251011244	Soil for disposal		12-31-2011	Tractor with Dump Trailer(s)
	RZ- #	38.09		

*Attach Additional Sheet if necessary

I hereby certify that the above-described materials are non-hazardous wastes as defined by 40 CFR 261 or any applicable state law. Further, that the above named materials are properly classified, described, packaged, marked and labeled, and are in proper condition for transportation according to the applicable regulations of the Department of Transportation.

Susan Crowley Generator/Authorized Agent Name Signature Date Shipped

TRANSPORTER INFORMATION

Transporter Name: Las Vegas Paving

DOT # 191949

Address: 4420 S. Decatur

Truck Number:

Las Vegas, NV 89103

Phone Number: (702) 353-4355

I certify no hazardous waste or other regulated substance was knowingly introduced to the waste while in my custody. The waste transported in this vehicle is the waste identified above, to the best of my knowledge.

Name of Authorized Agent Signature Date Delivered 10-8-10

DISPOSAL SITE INFORMATION

Site Name: Apex Regional Landfill

Phone No. (702) 599-5920

Address: 13550 U.S. Hwy 93 Las Vegas, NV

I hereby acknowledge receipt of the above described materials Name (Print or Type) Signature Date Received 10-8-10

81 Environmental Tech
13550 N Highway 93
Las Vegas, NV 89165

Ticket Type: INBOUND INVOICE

Ticket Number: 2113
Date: 10/08/2010
Time In: 10:12 am
Time Out: 10:36 am

Customer: 001011 - NGE, LLC c/o Northgate Environ Mgmt

Vehicle/Container: 82515P
Contract: Northgate Env. On Site Soils 3825 11
Comment: 443825-10-1244

Gross Weight: 135,500 LB Manual In
Tare Weight: 53,340 LB Manual Out
Net Weight: 82160 LB
Net Tons: 41.08

BOL: 12196

Origin	Yards	Material	Billing	Quantity
Not Applicable	0.00 YD	SW CONTAMINATED SOIL	41.08	TN

Driver:  144

Weighmaster: 

IN - GUILFDE OUT - MORENOJ

Indemnification. Customer agrees, by signature above, to indemnify, hold harmless, and defend Republic Services, Inc., its subsidiaries, affiliates, employees, officers and directors from and against any and all liabilities, claims, penalties, forfeitures, suits and the costs and expenses incident thereto, including costs of defense, settlement, and reasonable attorney's fees, which may be incurred, as a result of death or injuries to any person, or damage to any property, contamination of or adverse effects on the environment, caused in whole or in part by the Customer, its employees, or subcontractors in disposing waste at this Facility. In the event Customer delivers Unacceptable Waste (as determined by Republic) Customer agrees to assume all expenses and obligations with the removal and/or resolution of any effects caused by the delivery of such Unacceptable Waste.

Indemnización. Cliente acuerda indemnizar, mantener inmune, y defender Republic Services, Inc., sus subsidiarios, compañías, divisiones, empleados, oficiales y directores contra de cualquiera y de todas responsabilidades, demandas, penas, pérdidas, juicios, pleitos y los costos incidente además, incluyendo costos de defensa, de acuerdo judicial, y de honorarios razonables del abogado, que pueden ser incurridos en, o como resultado de, la muerte o herida personal a cualquier persona, o daños a cualquier característica, propiedad, contaminación de la tierra o efectos ilícitos en esta Facilidad, causado entero o en parte por el cliente, sus empleados, o sus subcontratistas en botar basura en esta Facilidad. En el caso que el Cliente entrega, bota, basura (según lo determinado por Republic) en este Establecimiento basura inaceptable en los reglamentos de este Establecimiento, el Cliente se compromete asumir todos los costos y obligaciones con el retiro y/o la resolución de cualquier dano(s) causado por la entrega de tal basura inaceptable.



NON-HAZARDOUS WASTE MANIFEST

MANIFEST # 12196

GENERATOR INFORMATION

Generator Name: Tronox LLC

Address: P.O. Box 55

City: Henderson County: Clark

State: NV Zip: 89009

Site Location (if different): 560 W. Lake Mead

Henderson, NV 89015 (702) 592-7727

CUSTOMER/BILLING INFORMATION

Billing Name: NGE LLC c/o Northgate Environment Management

Address: 300 Frank Ogawa Plaza, Ste 510

City: Oakland County: Alameda

State: CA Zip: 94612

Republic Services Approval #	Description of Waste	Volume/Weight	Expiration Date	Container Type
38251011244	Soil for disposal		12-31-2011	Tractor with Dump Trailer(s)
	RZ- _____ # _____	411.08		

*Attach Additional Sheet if necessary

I hereby certify that the above-described materials are non-hazardous wastes as defined by 40 CFR 261 or any applicable state law. Further, that the above named materials are properly classified, described, packaged, marked and labeled, and are in proper condition for transportation according to the applicable regulations of the Department of Transportation.

Susan Crowley Generator/Authorized Agent Name Signature Date Shipped

TRANSPORTER INFORMATION

Transporter Name: Las Vegas Paving

DOT # 191949

Address: 4420 S. Decatur

Truck Number: 144

Las Vegas, NV 89103

Phone Number: (702) 353-4355

I certify no hazardous waste or other regulated substance was knowingly introduced to the waste while in my custody. The waste transported in this vehicle is the waste identified above, to the best of my knowledge.

Name of Authorized Agent Signature Date Delivered

DISPOSAL SITE INFORMATION

Site Name: Apex Regional Landfill

Phone No. (702) 599-5920

Address: 13550 U.S. Hwy 93 Las Vegas, NV

I hereby acknowledge receipt of the above described materials

Name (Print or Type) Signature Date Received

81 Environmental Tech
13550 N Highway 93
Las Vegas, NV 89165

Ticket Type: INBOUND INVOICE

Ticket Number: 2114
Date: 10/08/2010
Time In: 10:17 am
Time Out: 10:42 am

Customer: 001011 - NGE, LLC c/o Northgate Environ Mgmt

Vehicle/Container: 73083P

Gross Weight: 133,420 LB Manual In
Tare Weight: 58,120 LB Manual Out
Net Weight: 75300 LB
Net Tons: 37.65

Contract: Northgate Env. On Site Soils 3825 11
Comment: ~~35~~ 3825-10-41244

BOL: 12198

Origin	Yards	Material	Billing Quantity
Not Applicable	0.00 YD	SW CONTAMINATED SOIL	37.65 TN

Driver: _____

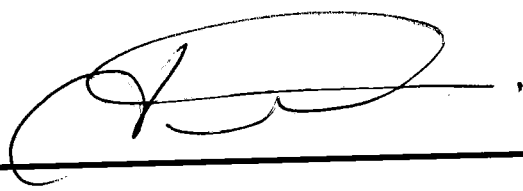

Weighmaster: _____



MORENOJ

Indemnification. Customer agrees, by signature above, to indemnify, hold harmless, and defend Republic Services, Inc., its subsidiaries, affiliates, employees, officers and directors from and against any and all liabilities, claims, penalties, forfeitures, suits and the costs and expenses incident thereto, including costs of defense, settlement, and reasonable attorney's fees, which may be incurred, as a result of death or injuries to any person, or damage to any property, contamination of or adverse effects on the environment, caused in whole or in part by the Customer, its employees, or subcontractors in disposing waste at this Facility. In the event Customer delivers Unacceptable Waste (as determined by Republic) Customer agrees to assume all expenses and obligations with the removal and/or resolution of any effects caused by the delivery of such Unacceptable Waste.

Indemnización. Cliente acuerda indemnizar, mantener inmune, y defender Republic Services, Inc., sus subsidiarios, compañías, divisiones, empleados, oficiales y directores contra de cualquiera y de todas responsabilidades, demandas, penas, pérdidas, juicios, pleitos y los costos incidente además, incluyendo costos de defensa, de acuerdo judicial, y de honorarios razonables del abogado, que pueden ser incurridos en, o como resultado de, la muerte o herida personal a cualquier persona, o daños a cualquier característica, propiedad, contaminación de la tierra o efectos ilícitos en esta Facilidad, causado entero o en parte por el cliente, sus empleados, o sus subcontratistas en botar basura en esta Facilidad. En el caso que el Cliente entrega, bota, basura (según lo determinado por Republic) en este Establecimiento basura inaceptable en los reglamentos de este Establecimiento, el Cliente se compromete asumir todos los costos y obligaciones con el retiro y/o la resolución de cualquier dano(s) causado por la entrega de tal basura inaceptable.



NON-HAZARDOUS WASTE MANIFEST

MANIFEST # 12198

GENERATOR INFORMATION

Generator Name: Tronox LLC
Address: P.O. Box 55
City: Henderson County: Clark
State: NV Zip: 89009
Site Location (if different): 560 W. Lake Mead
Henderson, NV 89015 (702) 592-7727

CUSTOMER/BILLING INFORMATION

Billing Name: NGE LLC c/o Northgate Environment Management
Address: 300 Frank Ogawa Plaza, Ste 510
City: Oakland County: Alameda
State: CA Zip: 94612

Table with 5 columns: Republic Services Approval #, Description of Waste, Volume/Weight, Expiration Date, Container Type. Row 1: 38251011244, Soil for disposal, 37.65, 12-31-2011, Tractor with Dump Trailer(s)

*Attach Additional Sheet if necessary

I hereby certify that the above-described materials are non-hazardous wastes as defined by 40 CFR 261 or any applicable state law. Further, that the above named materials are properly classified, described, packaged, marked and labeled, and are in proper condition for transportation according to the applicable regulations of the Department of Transportation.

Susan Crowley
Generator/Authorized Agent Name Signature Date Shipped

TRANSPORTER INFORMATION

Transporter Name: Las Vegas Paving DOT # 191949
Address: 4420 S. Decatur Truck Number:
Las Vegas, NV 89103 Phone Number: (702) 353-4355

I certify no hazardous waste or other regulated substance was knowingly introduced to the waste while in my custody. The waste transported in this vehicle is the waste identified above, to the best of my knowledge.

Juan Parra
Name of Authorized Agent Signature Date Delivered 10-8-10

DISPOSAL SITE INFORMATION

Site Name: Apex Regional Landfill Phone No. (702) 599-5920
Address: 13550 U.S. Hwy 93 Las Vegas, NV

I hereby acknowledge receipt of the above described materials
Name (Print or Type) Signature Date Received 10-8-10

81 Environmental Tech
13550 N Highway 93
Las Vegas, NV 89165

Ticket Type: INBOUND INVOICE

Ticket Number: 2115
Date: 10/08/2010
Time In: 10:23 am
Time Out: 10:51 am

Customer: 001011 - NGE, LLC c/o Northgate Environ Mgmt

Vehicle/Container: 84893P
Contract: Northgate Env. On Site Soils 3825 11
Comment: 303 3825-10 71244

Gross Weight: 137,360 LB Manual In
Tare Weight: 54,060 LB Manual Out
Net Weight: 83300 LB
Net Tons: 41.65

BOL: 12199

Origin	Yards	Material	Billing Quantity
Not Applicable	0.00 YD	SW CONTAMINATED SOIL	41.65 TN

Driver: _____



Weighmaster: _____



IN - GUILFDE OUT - MORENOJ

Indemnification. Customer agrees, by signature above, to indemnify, hold harmless, and defend Republic Services, Inc., its subsidiaries, affiliates, employees, officers and directors from and against any and all liabilities, claims, penalties, forfeitures, suits and the costs and expenses incident thereto, including costs of defense, settlement, and reasonable attorney's fees, which may be incurred, as a result of death or injuries to any person, or damage to any property, contamination of or adverse effects on the environment, caused in whole or in part by the Customer, its employees, or subcontractors in disposing waste at this Facility. In the event Customer delivers Unacceptable Waste (as determined by Republic) Customer agrees to assume all expenses and obligations with the removal and/or resolution of any effects caused by the delivery of such Unacceptable Waste.

Indemnización. Cliente acuerda indemnizar, mantener inmune, y defender Republic Services, Inc., sus subsidiarios, compañías, divisiones, empleados, oficiales y directores contra de cualquiera y de todas responsabilidades, demandas, penas, pérdidas, juicios, pleitos y los costos incidente además, incluyendo costos de defensa, de acuerdo judicial, y de honorarios razonables del abogado, que pueden ser incurridos en, o como resultado de, la muerte o herida personal a cualquier persona, o daños a cualquier característica, propiedad, contaminación de la tierra o efectos ilícitos en esta Facilidad, causado entero o en parte por el cliente, sus empleados, o sus subcontratistas en botar basura en esta Facilidad. En el caso que el Cliente entrega, bota, basura (según lo determinado por Republic) en este Establecimiento basura inaceptable en los reglamentos de este Establecimiento, el Cliente se compromete asumir todos los costos y obligaciones con el retiro y/o la resolución de cualquier dano(s) causado por la entrega de tal basura inaceptable.



NON-HAZARDOUS WASTE MANIFEST

MANIFEST # 12199

GENERATOR INFORMATION

Generator Name: Tronox LLC

Address: P.O. Box 55

City: Henderson County: Clark

State: NV Zip: 89009

Site Location (if different): 560 W. Lake Mead

Henderson, NV 89015 (702) 592-7727

CUSTOMER/BILLING INFORMATION

Billing Name: NGE LLC c/o Northgate Environment Management

Address: 300 Frank Ogawa Plaza, Ste 510

City: Oakland County: Alameda

State: CA Zip: 94612

Republic Services Approval #	Description of Waste	Volume/Weight	Expiration Date	Container Type
38251011244	Soil for disposal		12-31-2011	Tractor with Dump Trailer(s)
	RZ- _____ # _____	41.65		

*Attach Additional Sheet if necessary

I hereby certify that the above-described materials are non-hazardous wastes as defined by 40 CFR 261 or any applicable state law. Further, that the above named materials are properly classified, described, packaged, marked and labeled, and are in proper condition for transportation according to the applicable regulations of the Department of Transportation.

Susan Crowley
Generator/Authorized Agent Name Signature Date Shipped

TRANSPORTER INFORMATION

Transporter Name: Las Vegas Paving

DOT # 191949

Address: 4420 S. Decatur

Truck Number:

Las Vegas, NV 89103

Phone Number: (702) 353-4355

I certify no hazardous waste or other regulated substance was knowingly introduced to the waste while in my custody. The waste transported in this vehicle is the waste identified above, to the best of my knowledge.

Name of Authorized Agent Signature Date Delivered 10-8-10

DISPOSAL SITE INFORMATION

Site Name: Apex Regional Landfill

Phone No. (702) 599-5920

Address: 13550 U.S. Hwy 93 Las Vegas, NV

I hereby acknowledge receipt of the above described materials
Name (Print or Type) Signature Date Received 10-8-10

81 Environmental Tech
13550 N Highway 93
Las Vegas, NV 89165

Ticket Type: INBOUND INVOICE

Ticket Number: 2116
Date: 10/08/2010
Time In: 10:27 am
Time Out: 10:55 am

Customer: 001011 - NGE, LLC c/o Northgate Environ Mgmt

Vehicle/Container: 81495A

Gross Weight: 118,040 LB Manual In
Tare Weight: 46,420 LB Manual Out
Net Weight: 71620 LB
Net Tons: 35.81

Contract: Northgate Env. On Site Soils 3825 11

Comment: *175 3825 10 11244*

12200

Origin	Yards	Material	Billing Quantity
Not Applicable	0.00 YD	SW CONTAMINATED SOIL	35.81 TN

Driver: _____

Weighmaster: _____ *DS*

IN - GUILFDE OUT - MORENOJ

Indemnification. Customer agrees, by signature above, to indemnify, hold harmless, and defend Republic Services, Inc., its subsidiaries, affiliates, employees, officers and directors from and against any and all liabilities, claims, penalties, forfeitures, suits and the costs and expenses incident thereto, including costs of defense, settlement, and reasonable attorney's fees, which may be incurred, as a result of death or injuries to any person, or damage to any property, contamination of or adverse effects on the environment, caused in whole or in part by the Customer, its employees, or subcontractors in disposing waste at this Facility. In the event Customer delivers Unacceptable Waste (as determined by Republic) Customer agrees to assume all expenses and obligations with the removal and/or resolution of any effects caused by the delivery of such Unacceptable Waste.

Indemnización. Cliente acuerda indemnizar, mantener inmune, y defender Republic Services, Inc., sus subsidiarios, companias, divisiones, empleados, oficiales y directores contra de cualquiera y de todas responsabilidades, demandas, penas, pérdidas, juicios, pleitos y los costos incidente además, incluyendo costos de defensa, de acuerdo judicial, y de honorarios razonables del abogado, que pueden ser incurridos en, o como resultado de, la muerte o herida personal a cualquier persona, o daños a cualquier característica, propiedad, contaminación de la tierra o efectos ilicitos en esta Facilidad, causado entero o en parte por el cliente, sus empleados, o sus subcontratistas en botar basura en esta Facilidad. En el caso que el Cliente entrega, bota, basura (según lo determinado por Republic) en este Establecimiento basura inaceptable en los reglamentos de este Establecimiento, el Cliente se compromete asumir todos los costos y obligaciones con el retiro y/o la resolución de cualquier dano(s) causado por la entrega de tal basura inaceptable.



NON-HAZARDOUS WASTE MANIFEST

MANIFEST # 12200

GENERATOR INFORMATION

Generator Name: Tronox LLC

Address: P.O. Box 55

City: Henderson County: Clark

State: NV Zip: 89009

Site Location (if different): 560 W. Lake Mead

Henderson, NV 89015 (702) 592-7727

CUSTOMER/BILLING INFORMATION

Billing Name: NGE LLC c/o Northgate Environment Management

Address: 300 Frank Ogawa Plaza, Ste 510

City: Oakland County: Alameda

State: CA Zip: 94612

Republic Services Approval #	Description of Waste	Volume/Weight	Expiration Date	Container Type
38251011244	Soil for disposal		12-31-2011	Tractor with Dump Trailer(s)
	RZ-_____ # _____	3581		

*Attach Additional Sheet if necessary

I hereby certify that the above-described materials are non-hazardous wastes as defined by 40 CFR 261 or any applicable state law. Further, that the above named materials are properly classified, described, packaged, marked and labeled, and are in proper condition for transportation according to the applicable regulations of the Department of Transportation.

Susan Crowley Generator/Authorized Agent Name Signature Date Shipped

TRANSPORTER INFORMATION

Transporter Name: Las Vegas Paving

DOT # 191949

Address: 4420 S. Decatur

Truck Number:

Las Vegas, NV 89103

Phone Number: (702) 353-4355

I certify no hazardous waste or other regulated substance was knowingly introduced to the waste while in my custody. The waste transported in this vehicle is the waste identified above, to the best of my knowledge.

Andrew Walker Name of Authorized Agent Signature Date Delivered 10-8-10

DISPOSAL SITE INFORMATION

Site Name: Apex Regional Landfill

Phone No. (702) 599-5920

Address: 13550 U.S. Hwy 93 Las Vegas, NV

I hereby acknowledge receipt of the above described materials Name (Print or Type) Signature Date Received 10-8-10

81 Environmental Tech
13550 N Highway 93
Las Vegas, NV 89165

Ticket Type: INBOUND INVOICE

Ticket Number: 2117
Date: 10/08/2010
Time In: 10:30 am
Time Out: 10:58 am

Customer: 001011 - NGE, LLC c/o Northgate Environ Mgmt

Vehicle/Container: 81494P
Contract: Northgate Env. On Site Soils 3825 11
Comment: ~~125~~ 382510-11244

Gross Weight: 115,260 LB Manual In
Tare Weight: 46,860 LB Manual Out
Net Weight: 68400 LB
Net Tons: 34.20

BOL: 12201

Origin	Yards	Material	Billing	Quantity
Not Applicable	0.00 YD	SW CONTAMINATED SOIL	34.20	TN

Driver: _____



Weighmaster: _____



IN - GUILFDE OUT - MORENOJ

Indemnification. Customer agrees, by signature above, to indemnify, hold harmless, and defend Republic Services, Inc., its subsidiaries, affiliates, employees, officers and directors from and against any and all liabilities, claims, penalties, forfeitures, suits and the costs and expenses incident thereto, including costs of defense, settlement, and reasonable attorney's fees, which may be incurred, as a result of death or injuries to any person, or damage to any property, contamination of or adverse effects on the environment, caused in whole or in part by the Customer, its employees, or subcontractors in disposing waste at this Facility. In the event Customer delivers Unacceptable Waste (as determined by Republic) Customer agrees to assume all expenses and obligations with the removal and/or resolution of any effects caused by the delivery of such Unacceptable Waste.

Indemnización. Cliente acuerda indemnizar, mantener inmune, y defender Republic Services, Inc., sus subsidiarios, compañías, divisiones, empleados, oficiales y directores contra de cualquiera y de todas responsabilidades, demandas, penas, pérdidas, juicios, pleitos y los costos incidente además, incluyendo costos de defensa, de acuerdo judicial, y de honorarios razonables del abogado, que pueden ser incurridos en, o como resultado de, la muerte o herida personal a cualquier persona, o daños a cualquier característica, propiedad, contaminación de la tierra o efectos ilícitos en esta Facilidad, causado entero o en parte por el cliente, sus empleados, o sus subcontratistas en botar basura en esta Facilidad. En el caso que el Cliente entrega, bota, basura (según lo determinado por Republic) en este Establecimiento basura inaceptable en los reglamentos de este Establecimiento, el Cliente se compromete asumir todos los costos y obligaciones con el retiro y/o la resolución de cualquier dano(s) causado por la entrega de tal basura inaceptable.



NON-HAZARDOUS WASTE MANIFEST

MANIFEST # 12201

GENERATOR INFORMATION

Generator Name: Tronox LLC

Address: P.O. Box 55

City: Henderson County: Clark

State: NV Zip: 89009

Site Location (if different): 560 W. Lake Mead

Henderson, NV 89015 (702) 592-7727

CUSTOMER/BILLING INFORMATION

Billing Name: NGE LLC c/o Northgate Environment Management

Address: 300 Frank Ogawa Plaza, Ste 510

City: Oakland County: Alameda

State: CA Zip: 94612

Republic Services Approval #	Description of Waste	Volume/Weight	Expiration Date	Container Type
38251011244	Soil for disposal		12-31-2011	Tractor with Dump Trailer(s)
	RZ- #	34.20		

*Attach Additional Sheet if necessary

I hereby certify that the above-described materials are non-hazardous wastes as defined by 40 CFR 261 or any applicable state law. Further, that the above named materials are properly classified, described, packaged, marked and labeled, and are in proper condition for transportation according to the applicable regulations of the Department of Transportation.

Susan Crowley (Signature) Date Shipped

TRANSPORTER INFORMATION

Transporter Name: Las Vegas Paving

DOT # 191949

Address: 4420 S. Decatur

Truck Number: 125

Las Vegas, NV 89103

Phone Number: (702) 353-4355

I certify no hazardous waste or other regulated substance was knowingly introduced to the waste while in my custody. The waste transported in this vehicle is the waste identified above, to the best of my knowledge.

J. Bouyer (Signature) Date Delivered: 10-8-10

DISPOSAL SITE INFORMATION

Site Name: Apex Regional Landfill

Phone No. (702) 599-5920

Address: 13550 U.S. Hwy 93 Las Vegas, NV

I hereby acknowledge receipt of the above described materials

Debra J. J... (Signature) Date Received: 10-8-10

81 Environmental Tech
13550 N Highway 93
Las Vegas, NV 89165

Ticket Type: INBOUND INVOICE

Ticket Number: 2118
Date: 10/08/2010
Time In: 10:37 am
Time Out: 11:03 am

Customer: 001011 - NGE, LLC c/o Northgate Environ Mgmt

Vehicle/Container: 73072P
Contract: Northgate Env. On Site Soils 3825 11
Comment: ~~13550~~ 3825 10 11244

Gross Weight: 134,480 LB Manual In
Tare Weight: 50,320 LB Manual Out
Net Weight: 84160 LB
Net Tons: 42.08

BOL: 12202

Origin	Yards	Material	Billing	Quantity
Not Applicable	0.00 YD	SW CONTAMINATED SOIL	42.08	TN

Driver: _____



Weighmaster: _____



IN - GUILFDE OUT - MORENOJ

Indemnification. Customer agrees, by signature above, to indemnify, hold harmless, and defend Republic Services, Inc., its subsidiaries, affiliates, employees, officers and directors from and against any and all liabilities, claims, penalties, forfeitures, suits and the costs and expenses incident thereto, including costs of defense, settlement, and reasonable attorney's fees, which may be incurred, as a result of death or injuries to any person, or damage to any property, contamination of or adverse effects on the environment, caused in whole or in part by the Customer, its employees, or subcontractors in disposing waste at this Facility. In the event Customer delivers Unacceptable Waste (as determined by Republic) Customer agrees to assume all expenses and obligations with the removal and/or resolution of any effects caused by the delivery of such Unacceptable Waste.

Indemnización. Cliente acuerda indemnizar, mantener inmune, y defender Republic Services, Inc., sus subsidiarios, compañías, divisiones, empleados, oficiales y directores contra de cualquiera y de todas responsabilidades, demandas, penas, pérdidas, juicios, pleitos y los costos incidente además, incluyendo costos de defensa, de acuerdo judicial, y de honorarios razonables del abogado, que pueden ser incurridos en, o como resultado de, la muerte o herida personal a cualquier persona, o daños a cualquier característica, propiedad, contaminación de la tierra o efectos ilícitos en esta Facilidad, causado entero o en parte por el cliente, sus empleados, o sus subcontratistas en botar basura en esta Facilidad. En el caso que el Cliente entrega, bota, basura (según lo determinado por Republic) en este Establecimiento basura inaceptable en los reglamentos de este Establecimiento, el Cliente se compromete asumir todos los costos y obligaciones con el retiro y/o la resolución de cualquier dano(s) causado por la entrega de tal basura inaceptable.



NON-HAZARDOUS WASTE MANIFEST

MANIFEST # 12202

GENERATOR INFORMATION

Generator Name: Tronox LLC
Address: P.O. Box 55
City: Henderson County: Clark
State: NV Zip: 89009
Site Location (if different): 560 W. Lake Mead
Henderson, NV 89015 (702) 592-7727

CUSTOMER/BILLING INFORMATION

Billing Name: NGE LLC c/o Northgate Environment Management
Address: 300 Frank Ogawa Plaza, Ste 510
City: Oakland County: Alameda
State: CA Zip: 94612

Table with 5 columns: Republic Services Approval #, Description of Waste, Volume/Weight, Expiration Date, Container Type. Row 1: 38251011244, Soil for disposal, 42.08, 12-31-2011, Tractor with Dump Trailer(s).

*Attach Additional Sheet if necessary

I hereby certify that the above-described materials are non-hazardous wastes as defined by 40 CFR 261 or any applicable state law. Further, that the above named materials are properly classified, described, packaged, marked and labeled, and are in proper condition for transportation according to the applicable regulations of the Department of Transportation.

Susan Crowley (Signature) 10-8-10 (Date Shipped)
Generator/Authorized Agent Name Signature Date Shipped

TRANSPORTER INFORMATION

Transporter Name: Las Vegas Paving DOT # 191949
Address: 4420 S. Decatur Truck Number: 135
Las Vegas, NV 89103 Phone Number: (702) 353-4355

I certify no hazardous waste or other regulated substance was knowingly introduced to the waste while in my custody. The waste transported in this vehicle is the waste identified above, to the best of my knowledge.

Rod Lee (Signature) 10-8-10 (Date Delivered)
Name of Authorized Agent Signature Date Delivered

DISPOSAL SITE INFORMATION

Site Name: Apex Regional Landfill Phone No. (702) 599-5920
Address: 13550 U.S. Hwy 93 Las Vegas, NV

Juan Moreno (Signature) 10-8-10 (Date Received)
I hereby acknowledge receipt of the above described materials
Name (Print or Type) Signature Date Received

81 Environmental Tech
13550 N Highway 93
Las Vegas, NV 89165

Ticket Type: INBOUND INVOICE

Ticket Number: 2119
Date: 10/08/2010
Time In: 10:47 am
Time Out: 11:11 am

Customer: 001011 - NGE, LLC c/o Northgate Environ Mgmt

Vehicle/Container: 81496P

Contract: Northgate Env. On Site Soils 3825 11
Comment: ~~147~~ & 3825 10 11244

Gross Weight: 115,960 LB Manual In
Tare Weight: 50,660 LB Manual Out
Net Weight: 65300 LB
Net Tons: 32.65

BOL: 12203

Origin	Yards	Material	Billing	Quantity
Not Applicable	0.00 YD	SW CONTAMINATED SOIL	32.65 TN	

Driver: _____

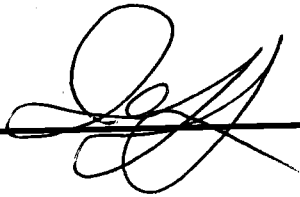

Weighmaster: _____

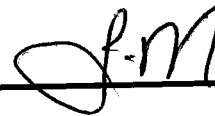

IN - GUILFDE OUT - MORENOJ

Indemnification. Customer agrees, by signature above, to indemnify, hold harmless, and defend Republic Services, Inc., its subsidiaries, affiliates, employees, officers and directors from and against any and all liabilities, claims, penalties, forfeitures, suits and the costs and expenses incident thereto, including costs of defense, settlement, and reasonable attorney's fees, which may be incurred, as a result of death or injuries to any person, or damage to any property, contamination of or adverse effects on the environment, caused in whole or in part by the Customer, its employees, or subcontractors in disposing waste at this Facility. In the event Customer delivers Unacceptable Waste (as determined by Republic) Customer agrees to assume all expenses and obligations with the removal and/or resolution of any effects caused by the delivery of such Unacceptable Waste.

Indemnización. Cliente acuerda indemnizar, mantener inmune, y defender Republic Services, Inc., sus subsidiarios, compañías, divisiones, empleados, oficiales y directores contra de cualquiera y de todas responsabilidades, demandas, penas, pérdidas, juicios, pleitos y los costos incidente además, incluyendo costos de defensa, de acuerdo judicial, y de honorarios razonables del abogado, que pueden ser incurridos en, o como resultado de, la muerte o herida personal a cualquier persona, o daños a cualquier característica, propiedad, contaminación de la tierra o efectos ilícitos en esta Facilidad, causado entero o en parte por el cliente, sus empleados, o sus subcontratistas en botar basura en esta Facilidad. En el caso que el Cliente entrega, bota, basura (según lo determinado por Republic) en este Establecimiento basura inaceptable en los reglamentos de este Establecimiento, el Cliente se compromete asumir todos los costos y obligaciones con el retiro y/o la resolución de cualquier dano(s) causado por la entrega de tal basura inaceptable.



NON-HAZARDOUS WASTE MANIFEST

MANIFEST # 12203

GENERATOR INFORMATION

Generator Name: Tronox LLC

Address: P.O. Box 55

City: Henderson County: Clark

State: NV Zip: 89009

Site Location (if different): 560 W. Lake Mead

Henderson, NV 89015 (702) 592-7727

CUSTOMER/BILLING INFORMATION

Billing Name: NGE LLC c/o Northgate Environment Management

Address: 300 Frank Ogawa Plaza, Ste 510

City: Oakland County: Alameda

State: CA Zip: 94612

Republic Services Approval #	Description of Waste	Volume/Weight	Expiration Date	Container Type
38251011244	Soil for disposal		12-31-2011	Tractor with Dump Trailer(s)
	RZ- _____ # _____	32.65		

*Attach Additional Sheet if necessary

I hereby certify that the above-described materials are non-hazardous wastes as defined by 40 CFR 261 or any applicable state law. Further, that the above named materials are properly classified, described, packaged, marked and labeled, and are in proper condition for transportation according to the applicable regulations of the Department of Transportation.

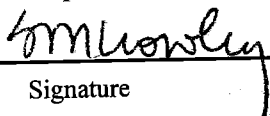
Susan Crowley  _____
 Generator/Authorized Agent Name Signature Date Shipped

TRANSPORTER INFORMATION

Transporter Name: Las Vegas Paving

DOT # 191949

Address: 4420 S. Decatur

Truck Number: 145

Las Vegas, NV 89103

Phone Number: (702) 353-4355

I certify no hazardous waste or other regulated substance was knowingly introduced to the waste while in my custody. The waste transported in this vehicle is the waste identified above, to the best of my knowledge.

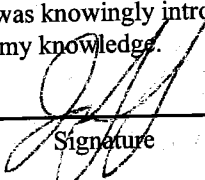
 Name of Authorized Agent  _____
 Signature Date Delivered 10-8-10

DISPOSAL SITE INFORMATION

Site Name: Apex Regional Landfill

Phone No. (702) 599-5920

Address: 13550 U.S. Hwy 93 Las Vegas, NV

I hereby acknowledge receipt of the above described materials

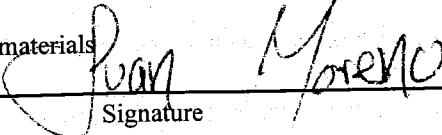
Juan Moreno  _____
 Name (Print or Type) Signature Date Received 10-08-10

81 Environmental Tech
13550 N Highway 93
Las Vegas, NV 89165

Ticket Type: INBOUND INVOICE

Ticket Number: 2120
Date: 10/08/2010
Time In: 10:50 am
Time Out: 11:13 am

Customer: 001011 - NGE, LLC c/o Northgate Environ Mgmt

Vehicle/Container: 60573P
Contract: Northgate Env. On Site Soils 3825 11
Comment: T42 && 3825 10 11244

Gross Weight: 132,760 LB Manual In
Tare Weight: 58,100 LB Manual Out
Net Weight: 74660 LB
Net Tons: 37.33

BOL: 12204

Origin	Yards	Material	Billing	Quantity
Not Applicable	0.00 YD	SW CONTAMINATED SOIL	37.33	TN

Driver: _____



Weighmaster: _____

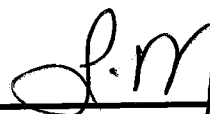

IN - GUILFDE OUT - MORENOJ

Indemnification. Customer agrees, by signature above, to indemnify, hold harmless, and defend Republic Services, Inc., its subsidiaries, affiliates, employees, officers and directors from and against any and all liabilities, claims, penalties, forfeitures, suits and the costs and expenses incident thereto, including costs of defense, settlement, and reasonable attorney's fees, which may be incurred, as a result of death or injuries to any person, or damage to any property, contamination of or adverse effects on the environment, caused in whole or in part by the Customer, its employees, or subcontractors in disposing waste at this Facility. In the event Customer delivers Unacceptable Waste (as determined by Republic) Customer agrees to assume all expenses and obligations with the removal and/or resolution of any effects caused by the delivery of such Unacceptable Waste.

Indemnización. Cliente acuerda indemnizar, mantener inmune, y defender Republic Services, Inc., sus subsidiarios, compañías, divisiones, empleados, oficiales y directores contra de cualquiera y de todas responsabilidades, demandas, penas, pérdidas, juicios, pleitos y los costos incidente además, incluyendo costos de defensa, de acuerdo judicial, y de honorarios razonables del abogado, que pueden ser incurridos en, o como resultado de, la muerte o herida personal a cualquier persona, o daños a cualquier característica, propiedad, contaminación de la tierra o efectos ilícitos en esta Facilidad, causado entero o en parte por el cliente, sus empleados, o sus subcontratistas en botar basura en esta Facilidad. En el caso que el Cliente entrega, bota, basura (según lo determinado por Republic) en este Establecimiento basura inaceptable en los reglamentos de este Establecimiento, el Cliente se compromete asumir todos los costos y obligaciones con el retiro y/o la resolución de cualquier dano(s) causado por la entrega de tal basura inaceptable.



NON-HAZARDOUS WASTE MANIFEST

MANIFEST # 12204

GENERATOR INFORMATION

Generator Name: Tronox LLC

Address: P.O. Box 55

City: Henderson County: Clark

State: NV Zip: 89009

Site Location (if different): 560 W. Lake Mead

Henderson, NV 89015 (702) 592-7727

CUSTOMER/BILLING INFORMATION

Billing Name: NGE LLC c/o Northgate Environment Management

Address: 300 Frank Ogawa Plaza, Ste 510

City: Oakland County: Alameda

State: CA Zip: 94612

Republic Services Approval #	Description of Waste	Volume/Weight	Expiration Date	Container Type
38251011244	Soil for disposal		12-31-2011	Tractor with Dump Trailer(s)
	RZ- #	37.33 TN		

*Attach Additional Sheet if necessary

I hereby certify that the above-described materials are non-hazardous wastes as defined by 40 CFR 261 or any applicable state law. Further, that the above named materials are properly classified, described, packaged, marked and labeled, and are in proper condition for transportation according to the applicable regulations of the Department of Transportation.

Susan Crowley (Signature) Generator/Authorized Agent Name Date Shipped

TRANSPORTER INFORMATION

Transporter Name: Las Vegas Paving

DOT # 191949

Address: 4420 S. Decatur

Truck Number: 142

Las Vegas, NV 89103

Phone Number: (702) 353-4355

I certify no hazardous waste or other regulated substance was knowingly introduced to the waste while in my custody. The waste transported in this vehicle is the waste identified above, to the best of my knowledge.

(Signature) Name of Authorized Agent Date Delivered 10.8.10

DISPOSAL SITE INFORMATION

Site Name: Apex Regional Landfill

Phone No. (702) 599-5920

Address: 13550 U.S. Hwy 93 Las Vegas, NV

I hereby acknowledge receipt of the above described materials (Signature) Name (Print or Type) Date Received 10-8-10

81 Environmental Tech
13550 N Highway 93
Las Vegas, NV 89165

Ticket Type: INBOUND INVOICE

Ticket Number: 2121
Date: 10/08/2010
Time In: 10:56 am
Time Out: 11:23 am

Customer: 001011 - NGE, LLC c/o Northgate Environ Mgmt

Vehicle/Container: 44264A
Contract: Northgate Env. On Site Soils 3825 11
Comment: 3825-10-11244

Gross Weight: 117,620 LB Manual In
Tare Weight: 56,100 LB Manual Out
Net Weight: 61,520 LB
Net Tons: 30.76

BOL: 12205

Origin	Yards	Material	Billing	Quantity
Not Applicable	0.00 YD	SW CONTAMINATED SOIL	30.76	TN

Driver: _____

AR

Weighmaster: _____

[Signature]

GUILFDE

Indemnification. Customer agrees, by signature above, to indemnify, hold harmless, and defend Republic Services, Inc., its subsidiaries, affiliates, employees, officers and directors from and against any and all liabilities, claims, penalties, forfeitures, suits and the costs and expenses incident thereto, including costs of defense, settlement, and reasonable attorney's fees, which may be incurred, as a result of death or injuries to any person, or damage to any property, contamination of or adverse effects on the environment, caused in whole or in part by the Customer, its employees, or subcontractors in disposing waste at this Facility. In the event Customer delivers Unacceptable Waste (as determined by Republic) Customer agrees to assume all expenses and obligations with the removal and/or resolution of any effects caused by the delivery of such Unacceptable Waste.

Indemnización. Cliente acuerda indemnizar, mantener inmune, y defender Republic Services, Inc., sus subsidiarios, compañías, divisiones, empleados, oficiales y directores contra de cualquiera y de todas responsabilidades, demandas, penas, pérdidas, juicios, pleitos y los costos incidente además, incluyendo costos de defensa, de acuerdo judicial, y de honorarios razonables del abogado, que pueden ser incurridos en, o como resultado de, la muerte o herida personal a cualquier persona, o daños a cualquier característica, propiedad, contaminación de la tierra o efectos ilícitos en esta Facilidad, causado entero o en parte por el cliente, sus empleados, o sus subcontratistas en botar basura en esta Facilidad. En el caso que el Cliente entrega, bota, basura (según lo determinado por Republic) en este Establecimiento basura inaceptable en los reglamentos de este Establecimiento, el Cliente se compromete asumir todos los costos y obligaciones con el retiro y/o la resolución de cualquier dano(s) causado por la entrega de tal basura inaceptable.



NON-HAZARDOUS WASTE MANIFEST

MANIFEST # 12205

GENERATOR INFORMATION

Generator Name: Tronox LLC

Address: P.O. Box 55

City: Henderson County: Clark

State: NV Zip: 89009

Site Location (if different): 560 W. Lake Mead

Henderson, NV 89015 (702) 592-7727

CUSTOMER/BILLING INFORMATION

Billing Name: NGE LLC c/o Northgate Environment Management

Address: 300 Frank Ogawa Plaza, Ste 510

City: Oakland County: Alameda

State: CA Zip: 94612

Republic Services Approval #	Description of Waste	Volume/Weight	Expiration Date	Container Type
38251011244	Soil for disposal		12-31-2011	Tractor with Dump Trailer(s)
	RZ- _____ # _____	30.76		

*Attach Additional Sheet if necessary

I hereby certify that the above-described materials are non-hazardous wastes as defined by 40 CFR 261 or any applicable state law. Further, that the above named materials are properly classified, described, packaged, marked and labeled, and are in proper condition for transportation according to the applicable regulations of the Department of Transportation.

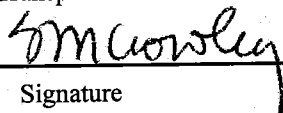
Susan Crowley  _____
 Generator/Authorized Agent Name Signature Date Shipped

TRANSPORTER INFORMATION

Transporter Name: Las Vegas Paving

DOT # 191949

Address: 4420 S. Decatur

Truck Number: RR100

Las Vegas, NV 89103

Phone Number: (702) 353-4355

I certify no hazardous waste or other regulated substance was knowingly introduced to the waste while in my custody. The waste transported in this vehicle is the waste identified above, to the best of my knowledge.

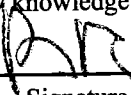
 _____ 10-8-10
 Name of Authorized Agent Signature Date Delivered

DISPOSAL SITE INFORMATION

Site Name: Apex Regional Landfill

Phone No. (702) 599-5920

Address: 13550 U.S. Hwy 93 Las Vegas, NV

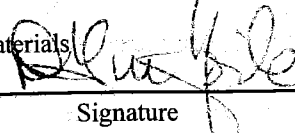
I hereby acknowledge receipt of the above described materials  _____ 10-8-10
 Name (Print or Type) Signature Date Received

81 Environmental Tech
13550 N Highway 93
Las Vegas, NV 89165

Ticket Type: INBOUND INVOICE

Ticket Number: 2122
Date: 10/08/2010
Time In: 11:02 am
Time Out: 11:26 am

Customer: 001011 - NGE, LLC c/o Northgate Environ Mgmt

Vehicle/Container: 58507P
Contract: Northgate Env. On Site Soils 3825 11
Comment: 3825 10 11244

Gross Weight: 119,840 LB Manual In
Tare Weight: 54,140 LB Manual Out
Net Weight: 65700 LB
Net Tons: 32.85

BOL: 12206

Origin	Yards	Material	Billing	Quantity
Not Applicable	0.00 YD	SW CONTAMINATED SOIL	32.85	TN

Driver: _____

Weighmaster: _____

IN - GUILFDE OUT - MORENOJ

Indemnification. Customer agrees, by signature above, to indemnify, hold harmless, and defend Republic Services, Inc., its subsidiaries, affiliates, employees, officers and directors from and against any and all liabilities, claims, penalties, forfeitures, suits and the costs and expenses incident thereto, including costs of defense, settlement, and reasonable attorney's fees, which may be incurred, as a result of death or injuries to any person, or damage to any property, contamination of or adverse effects on the environment, caused in whole or in part by the Customer, its employees, or subcontractors in disposing waste at this Facility. In the event Customer delivers Unacceptable Waste (as determined by Republic) Customer agrees to assume all expenses and obligations with the removal and/or resolution of any effects caused by the delivery of such Unacceptable Waste.

Indemnización. Cliente acuerda indemnizar, mantener inmune, y defender Republic Services, Inc., sus subsidiarios, compañías, divisiones, empleados, oficiales y directores contra de cualquiera y de todas responsabilidades, demandas, penas, pérdidas, juicios, pleitos y los costos incidente además, incluyendo costos de defensa, de acuerdo judicial, y de honorarios razonables del abogado, que pueden ser incurridos en, o como resultado de, la muerte o herida personal a cualquier persona, o daños a cualquier característica, propiedad, contaminación de la tierra o efectos ilícitos en esta Facilidad, causado entero o en parte por el cliente, sus empleados, o sus subcontratistas en botar basura en esta Facilidad. En el caso que el Cliente entrega, bota, basura (según lo determinado por Republic) en este Establecimiento basura inaceptable en los reglamentos de este Establecimiento, el Cliente se compromete asumir todos los costos y obligaciones con el retiro y/o la resolución de cualquier dano(s) causado por la entrega de tal basura inaceptable.



NON-HAZARDOUS WASTE MANIFEST

MANIFEST # 12206

GENERATOR INFORMATION

Generator Name: Tronox LLC

Address: P.O. Box 55

City: Henderson County: Clark

State: NV Zip: 89009

Site Location (if different): 560 W. Lake Mead

Henderson, NV 89015 (702) 592-7727

CUSTOMER/BILLING INFORMATION

Billing Name: NGE LLC c/o Northgate Environment Management

Address: 300 Frank Ogawa Plaza, Ste 510

City: Oakland County: Alameda

State: CA Zip: 94612

Republic Services Approval #	Description of Waste	Volume/Weight	Expiration Date	Container Type
38251011244	Soil for disposal		12-31-2011	Tractor with Dump Trailer(s)
	RZ- _____ # _____	32.85 TR		

*Attach Additional Sheet if necessary

I hereby certify that the above-described materials are non-hazardous wastes as defined by 40 CFR 261 or any applicable state law. Further, that the above named materials are properly classified, described, packaged, marked and labeled, and are in proper condition for transportation according to the applicable regulations of the Department of Transportation.

Susan Crowley Generator/Authorized Agent Name Signature Date Shipped

TRANSPORTER INFORMATION

Transporter Name: Las Vegas Paving

DOT # 191949

Address: 4420 S. Decatur

Truck Number: 1020

Las Vegas, NV 89103

Phone Number: (702) 353-4355

I certify no hazardous waste or other regulated substance was knowingly introduced to the waste while in my custody. The waste transported in this vehicle is the waste identified above, to the best of my knowledge.

Name of Authorized Agent Signature Date Delivered 10-8-10

DISPOSAL SITE INFORMATION

Site Name: Apex Regional Landfill

Phone No. (702) 599-5920

Address: 13550 U.S. Hwy 93 Las Vegas, NV

I hereby acknowledge receipt of the above described materials Juan Moreno Signature Date Received 10-8-10

81 Environmental Tech
13550 N Highway 93
Las Vegas, NV 89165

Ticket Type: INBOUND INVOICE

Ticket Number: 2123
Date: 10/08/2010
Time In: 11:06 am
Time Out: 11:34 am

Customer: 001011 - NGE, LLC c/o Northgate Environ Mgmt

Vehicle/Container: 86673P
Contract: Northgate Env. On Site Soils 3825 11
Comment: 3825 10 11244

Gross Weight: 130,220 LB Manual In
Tare Weight: 54,560 LB Manual Out
Net Weight: 75660 LB
Net Tons: 37.83

BOL: 12207

Origin	Yards	Material	Billing	Quantity
Not Applicable	0.00 YD	SW CONTAMINATED SOIL	37.83	TN

Driver: 

Weighmaster: 

IN - GUILFDE OUT - MORENOJ

Indemnification. Customer agrees, by signature above, to indemnify, hold harmless, and defend Republic Services, Inc., its subsidiaries, affiliates, employees, officers and directors from and against any and all liabilities, claims, penalties, forfeitures, suits and the costs and expenses incident thereto, including costs of defense, settlement, and reasonable attorney's fees, which may be incurred, as a result of death or injuries to any person, or damage to any property, contamination of or adverse effects on the environment, caused in whole or in part by the Customer, its employees, or subcontractors in disposing waste at this Facility. In the event Customer delivers Unacceptable Waste (as determined by Republic) Customer agrees to assume all expenses and obligations with the removal and/or resolution of any effects caused by the delivery of such Unacceptable Waste.

Indemnización. Cliente acuerda indemnizar, mantener inmune, y defender Republic Services, Inc., sus subsidiarios, compañías, divisiones, empleados, oficiales y directores contra de cualquiera y de todas responsabilidades, demandas, penas, pérdidas, juicios, pleitos y los costos incidente además, incluyendo costos de defensa, de acuerdo judicial, y de honorarios razonables del abogado, que pueden ser incurridos en, o como resultado de, la muerte o herida personal a cualquier persona, o daños a cualquier característica, propiedad, contaminación de la tierra o efectos ilícitos en esta Facilidad, causado entero o en parte por el cliente, sus empleados, o sus subcontratistas en botar basura en esta Facilidad. En el caso que el Cliente entrega, bota, basura (según lo determinado por Republic) en este Establecimiento basura inaceptable en los reglamentos de este Establecimiento, el Cliente se compromete asumir todos los costos y obligaciones con el retiro y/o la resolución de cualquier dano(s) causado por la entrega de tal basura inaceptable.



NON-HAZARDOUS WASTE MANIFEST

MANIFEST # 12207

GENERATOR INFORMATION

Generator Name: Tronox LLC

Address: P.O. Box 55

City: Henderson County: Clark

State: NV Zip: 89009

Site Location (if different): 560 W. Lake Mead

Henderson, NV 89015 (702) 592-7727

CUSTOMER/BILLING INFORMATION

Billing Name: NGE LLC c/o Northgate Environment Management

Address: 300 Frank Ogawa Plaza, Ste 510

City: Oakland County: Alameda

State: CA Zip: 94612

Republic Services Approval #	Description of Waste	Volume/Weight	Expiration Date	Container Type
38251011244	Soil for disposal		12-31-2011	Tractor with Dump Trailer(s)
	RZ- #	37.83		

*Attach Additional Sheet if necessary

I hereby certify that the above-described materials are non-hazardous wastes as defined by 40 CFR 261 or any applicable state law. Further, that the above named materials are properly classified, described, packaged, marked and labeled, and are in proper condition for transportation according to the applicable regulations of the Department of Transportation.

Susan Crowley (Signature) Generator/Authorized Agent Name Date Shipped

TRANSPORTER INFORMATION

Transporter Name: Las Vegas Paving

DOT # 191949

Address: 4420 S. Decatur

Truck Number: STS 8

Las Vegas, NV 89103

Phone Number: (702) 353-4355

I certify no hazardous waste or other regulated substance was knowingly introduced to the waste while in my custody. The waste transported in this vehicle is the waste identified above, to the best of my knowledge.

(Signature) Name of Authorized Agent Date Delivered 10-8-10

DISPOSAL SITE INFORMATION

Site Name: Apex Regional Landfill

Phone No. (702) 599-5920

Address: 13550 U.S. Hwy 93 Las Vegas, NV

Juan Moreno (Signature) Name (Print or Type) Date Received 10-8-10

81 Environmental Tech
13550 N Highway 93
Las Vegas, NV 89165

Ticket Type: INBOUND INVOICE

Ticket Number: 2124
Date: 10/08/2010
Time In: 11:15 am
Time Out: 11:41 am

Customer: 001011 - NGE, LLC c/o Northgate Environ Mgmt

Vehicle/Container: 86680P
Contract: Northgate Env. On Site Soils 3825 11
Comment: 3825 10 11244

Gross Weight: 118,580 LB Manual In
Tare Weight: 49,640 LB Manual Out
Net Weight: 68940 LB
Net Tons: 34.47

BOL: 12208

Origin	Yards	Material	Billing	Quantity
Not Applicable	0.00 YD	SW CONTAMINATED SOIL	34.47	TN

Driver: _____



Weighmaster: _____

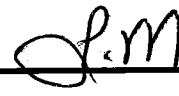

IN - GUILFDE OUT - MORENOJ

Indemnification. Customer agrees, by signature above, to indemnify, hold harmless, and defend Republic Services, Inc., its subsidiaries, affiliates, employees, officers and directors from and against any and all liabilities, claims, penalties, forfeitures, suits and the costs and expenses incident thereto, including costs of defense, settlement, and reasonable attorney's fees, which may be incurred, as a result of death or injuries to any person, or damage to any property, contamination of or adverse effects on the environment, caused in whole or in part by the Customer, its employees, or subcontractors in disposing waste at this Facility. In the event Customer delivers Unacceptable Waste (as determined by Republic) Customer agrees to assume all expenses and obligations with the removal and/or resolution of any effects caused by the delivery of such Unacceptable Waste.

Indemnización. Cliente acuerda indemnizar, mantener inmune, y defender Republic Services, Inc., sus subsidiarios, compañías, divisiones, empleados, oficiales y directores contra de cualquiera y de todas responsabilidades, demandas, penas, pérdidas, juicios, pleitos y los costos incidente además, incluyendo costos de defensa, de acuerdo judicial, y de honorarios razonables del abogado, que pueden ser incurridos en, o como resultado de, la muerte o herida personal a cualquier persona, o daños a cualquier característica, propiedad, contaminación de la tierra o efectos ilícitos en esta Facilidad, causado entero o en parte por el cliente, sus empleados, o sus subcontratistas en botar basura en esta Facilidad. En el caso que el Cliente entrega, bota, basura (según lo determinado por Republic) en este Establecimiento basura inaceptable en los reglamentos de este Establecimiento, el Cliente se compromete asumir todos los costos y obligaciones con el retiro y/o la resolución de cualquier dano(s) causado por la entrega de tal basura inaceptable.



NON-HAZARDOUS WASTE MANIFEST MANIFEST # 12208

GENERATOR INFORMATION

Generator Name: Tronox LLC
Address: P.O. Box 55
City: Henderson County: Clark
State: NV Zip: 89009
Site Location (if different): 560 W. Lake Mead
Henderson, NV 89015 (702) 592-7727

CUSTOMER/BILLING INFORMATION

Billing Name: NGE LLC c/o Northgate Environment Management
Address: 300 Frank Ogawa Plaza, Ste 510
City: Oakland County: Alameda
State: CA Zip: 94612

Table with 5 columns: Republic Services Approval #, Description of Waste, Volume/Weight, Expiration Date, Container Type. Row 1: 38251011244, Soil for disposal, 34.47, 12-31-2011, Tractor with Dump Trailer(s).

*Attach Additional Sheet if necessary

I hereby certify that the above-described materials are non-hazardous wastes as defined by 40 CFR 261 or any applicable state law. Further, that the above named materials are properly classified, described, packaged, marked and labeled, and are in proper condition for transportation according to the applicable regulations of the Department of Transportation.

Susan Crowley
Generator/Authorized Agent Name Signature Date Shipped

TRANSPORTER INFORMATION

Transporter Name: Las Vegas Paving DOT # 191949
Address: 4420 S. Decatur Truck Number: 110
Las Vegas, NV 89103 Phone Number: (702) 353-4355

I certify no hazardous waste or other regulated substance was knowingly introduced to the waste while in my custody. The waste transported in this vehicle is the waste identified above, to the best of my knowledge.

Name of Authorized Agent Signature Date Delivered 10-8-10

DISPOSAL SITE INFORMATION

Site Name: Apex Regional Landfill Phone No. (702) 599-5920
Address: 13550 U.S. Hwy 93 Las Vegas, NV

I hereby acknowledge receipt of the above described materials
Juan Moreno Signature Date Received 10-8-10

81 Environmental Tech
13550 N Highway 93
Las Vegas, NV 89165

Ticket Type: INBOUND INVOICE

Ticket Number: 2125
Date: 10/08/2010
Time In: 11:18 am
Time Out: 11:45 am

Customer: 001011 - NGE, LLC c/o Northgate Environ Mgmt

Vehicle/Container: 29573A
Contract: Northgate Env. On Site Soils 3825 11
Comment: 3825 10 11244

Gross Weight: 131,640 LB Manual In
Tare Weight: 53,040 LB Manual Out
Net Weight: 78600 LB
Net Tons: 39.30

BOL: 12209

Origin	Yards	Material	Billing	Quantity
Not Applicable	0.00 YD	SW CONTAMINATED SOIL	39.30	TN

Driver: _____

Weighmaster: _____

IN - GUILFDE OUT - MORENOJ

Indemnification. Customer agrees, by signature above, to indemnify, hold harmless, and defend Republic Services, Inc., its subsidiaries, affiliates, employees, officers and directors from and against any and all liabilities, claims, penalties, forfeitures, suits and the costs and expenses incident thereto, including costs of defense, settlement, and reasonable attorney's fees, which may be incurred, as a result of death or injuries to any person, or damage to any property, contamination of or adverse effects on the environment, caused in whole or in part by the Customer, its employees, or subcontractors in disposing waste at this Facility. In the event Customer delivers Unacceptable Waste (as determined by Republic) Customer agrees to assume all expenses and obligations with the removal and/or resolution of any effects caused by the delivery of such Unacceptable Waste.

Indemnización. Cliente acuerda indemnizar, mantener inmune, y defender Republic Services, Inc., sus subsidiarios, compañías, divisiones, empleados, oficiales y directores contra de cualquiera y de todas responsabilidades, demandas, penas, pérdidas, juicios, pleitos y los costos incidente además, incluyendo costos de defensa, de acuerdo judicial, y de honorarios razonables del abogado, que pueden ser incurridos en, o como resultado de, la muerte o herida personal a cualquier persona, o daños a cualquier característica, propiedad, contaminación de la tierra o efectos ilícitos en esta Facilidad, causado entero o en parte por el cliente, sus empleados, o sus subcontratistas en botar basura en esta Facilidad. En el caso que el Cliente entrega, bota, basura (según lo determinado por Republic) en este Establecimiento basura inaceptable en los reglamentos de este Establecimiento, el Cliente se compromete asumir todos los costos y obligaciones con el retiro y/o la resolución de cualquier dano(s) causado por la entrega de tal basura inaceptable.



NON-HAZARDOUS WASTE MANIFEST

MANIFEST # 12209

GENERATOR INFORMATION

Generator Name: Tronox LLC

Address: P.O. Box 55

City: Henderson County: Clark

State: NV Zip: 89009

Site Location (if different): 560 W. Lake Mead
Henderson, NV 89015 (702) 592-7727

CUSTOMER/BILLING INFORMATION

Billing Name: NGE LLC c/o Northgate Environment Management

Address: 300 Frank Ogawa Plaza, Ste 510

City: Oakland County: Alameda

State: CA Zip: 94612

Table with 5 columns: Republic Services Approval #, Description of Waste, Volume/Weight, Expiration Date, Container Type. Row 1: 38251011244, Soil for disposal, 39.30 TN, 12-31-2011, Tractor with Dump Trailer(s).

*Attach Additional Sheet if necessary

I hereby certify that the above-described materials are non-hazardous wastes as defined by 40 CFR 261 or any applicable state law. Further, that the above named materials are properly classified, described, packaged, marked and labeled, and are in proper condition for transportation according to the applicable regulations of the Department of Transportation.

Susan Crowley (Name), Tom Crowley (Signature), Date Shipped

TRANSPORTER INFORMATION

Transporter Name: Las Vegas Paving DOT # 191949

Address: 4420 S. Decatur Truck Number: 17

Las Vegas, NV 89103 Phone Number: (702) 353-4355

I certify no hazardous waste or other regulated substance was knowingly introduced to the waste while in my custody. The waste transported in this vehicle is the waste identified above, to the best of my knowledge.

Name of Authorized Agent, Signature, Date Delivered: 10-8-10

DISPOSAL SITE INFORMATION

Site Name: Apex Regional Landfill Phone No. (702) 599-5920

Address: 13550 U.S. Hwy 93 Las Vegas, NV

They acknowledge receipt of the above described materials. Juan Moreno (Name), Juan Moreno (Signature), Date Received: 10-8-10

81 Environmental Tech
13550 N Highway 93
Las Vegas, NV 89165

Ticket Type: INBOUND INVOICE

Ticket Number: 2126
Date: 10/08/2010
Time In: 11:28 am
Time Out: 11:56 am

Customer: 001011 - NGE, LLC c/o Northgate Environ Mgmt

Vehicle/Container: 85914P
Contract: Northgate Env. On Site Soils 3825 1t
Comment: 3825-10-11244

Gross Weight: 125,040 LB Manual In
Tare Weight: 53,600 LB Manual Out
Net Weight: 71440 LB
Net Tons: 35.72

BOL: 12210

Origin	Yards	Material	Billing	Quantity
Not Applicable	0.00 YD	SW CONTAMINATED SOIL	35.72	TN

Driver:



Weighmaster:

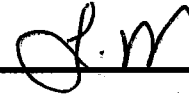

IN - GUILFDE OUT - MORENOJ

Indemnification. Customer agrees, by signature above, to indemnify, hold harmless, and defend Republic Services, Inc., its subsidiaries, affiliates, employees, officers and directors from and against any and all liabilities, claims, penalties, forfeitures, suits and the costs and expenses incident thereto, including costs of defense, settlement, and reasonable attorney's fees, which may be incurred, as a result of death or injuries to any person, or damage to any property, contamination of or adverse effects on the environment, caused in whole or in part by the Customer, its employees, or subcontractors in disposing waste at this Facility. In the event Customer delivers Unacceptable Waste (as determined by Republic) Customer agrees to assume all expenses and obligations with the removal and/or resolution of any effects caused by the delivery of such Unacceptable Waste.

Indemnización. Cliente acuerda indemnizar, mantener inmune, y defender Republic Services, Inc., sus subsidiarios, compañías, divisiones, empleados, oficiales y directores contra de cualquiera y de todas responsabilidades, demandas, penas, pérdidas, juicios, pleitos y los costos incidente además, incluyendo costos de defensa, de acuerdo judicial, y de honorarios razonables del abogado, que pueden ser incurridos en, o como resultado de, la muerte o herida personal a cualquier persona, o daños a cualquier característica, propiedad, contaminación de la tierra o efectos ilícitos en esta Facilidad, causado entero o en parte por el cliente, sus empleados, o sus subcontratistas en botar basura en esta Facilidad. En el caso que el Cliente entrega, bota, basura (según lo determinado por Republic) en este Establecimiento basura inaceptable en los reglamentos de este Establecimiento, el Cliente se compromete asumir todos los costos y obligaciones con el retiro y/o la resolución de cualquier dano(s) causado por la entrega de tal basura inaceptable.



NON-HAZARDOUS WASTE MANIFEST

MANIFEST # 12210

GENERATOR INFORMATION

Generator Name: Tronox LLC
Address: P.O. Box 55
City: Henderson County: Clark
State: NV Zip: 89009
Site Location (if different): 560 W. Lake Mead
Henderson, NV 89015 (702) 592-7727

CUSTOMER/BILLING INFORMATION

Billing Name: NGE LLC c/o Northgate Environment Management
Address: 300 Frank Ogawa Plaza, Ste 510
City: Oakland County: Alameda
State: CA Zip: 94612

Table with 5 columns: Republic Services Approval #, Description of Waste, Volume/Weight, Expiration Date, Container Type. Row 1: 38251011244, Soil for disposal, 35.72, 12-31-2011, Tractor with Dump Trailer(s).

*Attach Additional Sheet if necessary

I hereby certify that the above-described materials are non-hazardous wastes as defined by 40 CFR 261 or any applicable state law. Further, that the above named materials are properly classified, described, packaged, marked and labeled, and are in proper condition for transportation according to the applicable regulations of the Department of Transportation.

Susan Crowley
Generator/Authorized Agent Name Signature Date Shipped

TRANSPORTER INFORMATION

Transporter Name: Las Vegas Paving DOT # 191949
Address: 4420 S. Decatur Truck Number: 07
Las Vegas, NV 89103 Phone Number: (702) 353-4355

I certify no hazardous waste or other regulated substance was knowingly introduced to the waste while in my custody. The waste transported in this vehicle is the waste identified above, to the best of my knowledge.

DAVID DEL CID
Name of Authorized Agent Signature Date Delivered 10-8-10

DISPOSAL SITE INFORMATION

Site Name: Apex Regional Landfill Phone No. (702) 599-5920
Address: 13550 U.S. Hwy 93 Las Vegas, NV

I hereby acknowledge receipt of the above described materials
Juan Moreno
Name (Print or Type) Signature Date Received 10-8-10

81 Environmental Tech
13550 N Highway 93
Las Vegas, NV 89165

Ticket Type: INBOUND INVOICE

Ticket Number: 2127
Date: 10/08/2010
Time In: 11:34 am
Time Out: 12:02 pm

Customer: 001011 - NGE, LLC c/o Northgate Environ Mgmt

Vehicle/Container: 44164A
Contract: Northgate Env. On Site Soils 3825 1l
Comment: 3825-10-11244

Gross Weight: 130,740 LB Manual In
Tare Weight: 56,080 LB Manual Out
Net Weight: 74660 LB
Net Tons: 37.33

BOL: 12211

Origin	Yards	Material	Billing	Quantity
Not Applicable	0.00 YD	SW CONTAMINATED SOIL	37.33	TN

Driver:



Weighmaster:

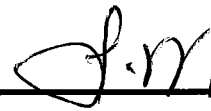

IN - GUILFDE OUT - MORENOJ

Indemnification. Customer agrees, by signature above, to indemnify, hold harmless, and defend Republic Services, Inc., its subsidiaries, affiliates, employees, officers and directors from and against any and all liabilities, claims, penalties, forfeitures, suits and the costs and expenses incident thereto, including costs of defense, settlement, and reasonable attorney's fees, which may be incurred, as a result of death or injuries to any person, or damage to any property, contamination of or adverse effects on the environment, caused in whole or in part by the Customer, its employees, or subcontractors in disposing waste at this Facility. In the event Customer delivers Unacceptable Waste (as determined by Republic) Customer agrees to assume all expenses and obligations with the removal and/or resolution of any effects caused by the delivery of such Unacceptable Waste.

Indemnización. Cliente acuerda indemnizar, mantener inmune, y defender Republic Services, Inc., sus subsidiarios, compañías, divisiones, empleados, oficiales y directores contra de cualquiera y de todas responsabilidades, demandas, penas, pérdidas, juicios, pleitos y los costos incidente además, incluyendo costos de defensa, de acuerdo judicial, y de honorarios razonables del abogado, que pueden ser incurridos en, o como resultado de, la muerte o herida personal a cualquier persona, o daños a cualquier característica, propiedad, contaminación de la tierra o efectos ilícitos en esta Facilidad, causado entero o en parte por el cliente, sus empleados, o sus subcontratistas en botar basura en esta Facilidad. En el caso que el Cliente entrega, bota, basura (según lo determinado por Republic) en este Establecimiento basura inaceptable en los reglamentos de este Establecimiento, el Cliente se compromete asumir todos los costos y obligaciones con el retiro y/o la resolución de cualquier dano(s) causado por la entrega de tal basura inaceptable.



NON-HAZARDOUS WASTE MANIFEST

MANIFEST # 12211

GENERATOR INFORMATION

Generator Name: Tronox LLC
Address: P.O. Box 55
City: Henderson County: Clark
State: NV Zip: 89009
Site Location (if different): 560 W. Lake Mead
Henderson, NV 89015 (702) 592-7727

CUSTOMER/BILLING INFORMATION

Billing Name: NGE LLC c/o Northgate Environment Management
Address: 300 Frank Ogawa Plaza, Ste 510
City: Oakland County: Alameda
State: CA Zip: 94612

Table with 5 columns: Republic Services Approval #, Description of Waste, Volume/Weight, Expiration Date, Container Type. Row 1: 38251011244, Soil for disposal, 37.33, 12-31-2011, Tractor with Dump Trailer(s).

*Attach Additional Sheet if necessary

I hereby certify that the above-described materials are non-hazardous wastes as defined by 40 CFR 261 or any applicable state law. Further, that the above named materials are properly classified, described, packaged, marked and labeled, and are in proper condition for transportation according to the applicable regulations of the Department of Transportation.

Susan Crowley
Generator/Authorized Agent Name Signature Date Shipped

TRANSPORTER INFORMATION

Transporter Name: Las Vegas Paving DOT # 191949
Address: 4420 S. Decatur Truck Number: K-006
Las Vegas, NV 89103 Phone Number: (702) 353-4355

I certify no hazardous waste or other regulated substance was knowingly introduced to the waste while in my custody. The waste transported in this vehicle is the waste identified above, to the best of my knowledge.

Brian Mulvey
Name of Authorized Agent Signature Date Delivered 10-8-10

DISPOSAL SITE INFORMATION

Site Name: Apex Regional Landfill Phone No. (702) 599-5920
Address: 13550 U.S. Hwy 93 Las Vegas, NV

Juan Moreno
I hereby acknowledge receipt of the above described materials
Name (Print or Type) Signature Date Received 10-8-10

REPRINT

81 Environmental Tech
13550 N Highway 93
Las Vegas, NV 89165

Ticket Type: INBOUND INVOICE

Ticket Number: 2128
Date: 10/08/2010
Time In: 11:36 am
Time Out: 12:06 pm

Customer: 001011 - NGE, LLC c/o Northgate Environ Mgmt

Vehicle/Container: 68628P
Contract: Northgate Env. On Site Soils 3825 11
Comment: 3825 10 11244

Gross Weight: 129,440 LB Manual In
Tare Weight: 54,820 LB Manual Out
Net Weight: 74620 LB
Net Tons: 37.31

BOL: 12212

Origin	Yards	Material	Billing Quantity
Not Applicable	0.00 YD	SW CONTAMINATED SOIL	37.31 TN

Driver: _____



Weighmaster: _____

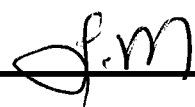

IN - GUILFDE OUT - MORENOJ

Indemnification. Customer agrees, by signature above, to indemnify, hold harmless, and defend Republic Services, Inc., its subsidiaries, affiliates, employees, officers and directors from and against any and all liabilities, claims, penalties, forfeitures, suits and the costs and expenses incident thereto, including costs of defense, settlement, and reasonable attorney's fees, which may be incurred, as a result of death or injuries to any person, or damage to any property, contamination of or adverse effects on the environment, caused in whole or in part by the Customer, its employees, or subcontractors in disposing waste at this Facility. In the event Customer delivers Unacceptable Waste (as determined by Republic) Customer agrees to assume all expenses and obligations with the removal and/or resolution of any effects caused by the delivery of such Unacceptable Waste.

Indemnización. Cliente acuerda indemnizar, mantener inmune, y defender Republic Services, Inc., sus subsidiarios, companias, divisiones, empleados, oficiales y directores contra de cualquiera y de todas responsabilidades, demandas, penas, pérdidas, juicios, pleitos y los costos incidente además, incluyendo costos de defensa, de acuerdo judicial, y de honorarios razonables del abogado, que pueden ser incurridos en, o como resultado de, la muerte o herida personal a cualquier persona, o daños a cualquier característica, propiedad, contaminación de la tierra o efectos ilicitos en esta Facilidat, causado entero o en parte por el cliente, sus empleados, o sus subcontratistas en botar basura en esta Facilidat. En el caso que el Cliente entrega, bota, basura (según lo determinado por Republic) en este Establecimiento basura inaceptable en los reglamentos de este Establecimiento, el Cliente se compromete asumir todos los costos y obligaciones con el retiro y/o la resolución de cualquier dano(s) causado por la entrega de tal basura inaceptable.



NON-HAZARDOUS WASTE MANIFEST

MANIFEST # 12212

GENERATOR INFORMATION

Generator Name: Tronox LLC

Address: P.O. Box 55

City: Henderson County: Clark

State: NV Zip: 89009

Site Location (if different): 560 W. Lake Mead
Henderson, NV 89015 (702) 592-7727

CUSTOMER/BILLING INFORMATION

Billing Name: NGE LLC c/o Northgate Environment Management

Address: 300 Frank Ogawa Plaza, Ste 510

City: Oakland County: Alameda

State: CA Zip: 94612

Table with 5 columns: Republic Services Approval #, Description of Waste, Volume/Weight, Expiration Date, Container Type. Row 1: 38251011244, Soil for disposal, 57.31 TN, 12-31-2011, Tractor with Dump Trailer(s).

*Attach Additional Sheet if necessary

I hereby certify that the above-described materials are non-hazardous wastes as defined by 40 CFR 261 or any applicable state law. Further, that the above named materials are properly classified, described, packaged, marked and labeled, and are in proper condition for transportation according to the applicable regulations of the Department of Transportation.

Susan Crowley (Signature)
Generator/Authorized Agent Name Signature Date Shipped

TRANSPORTER INFORMATION

Transporter Name: Las Vegas Paving

DOT # 191949

Address: 4420 S. Decatur

Truck Number: RH 301

Las Vegas, NV 89103

Phone Number: (702) 353-4355

I certify no hazardous waste or other regulated substance was knowingly introduced to the waste while in my custody. The waste transported in this vehicle is the waste identified above, to the best of my knowledge.

J J T (Signature) 10-8-10 (Date)
Name of Authorized Agent Signature Date Delivered

DISPOSAL SITE INFORMATION

Site Name: Apex Regional Landfill

Phone No. (702) 599-5920

Address: 13550 U.S. Hwy 93 Las Vegas, NV

Juan Moreno (Signature) 10-8-10 (Date)
Name (Print or Type) Signature Date Received

81 Environmental Tech
13550 N Highway 93
Las Vegas, NV 89165

Ticket Type: INBOUND INVOICE

Ticket Number: 2129
Date: 10/08/2010
Time In: 11:43 am
Time Out: 12:08 pm

Customer: 001011 - NGE, LLC c/o Northgate Environ Mgmt

Vehicle/Container: 192391
Contract: Northgate Env. On Site Soils 3825 10
Comment: 3825 10 11244

Gross Weight: 92,260 LB Manual In
Tare Weight: 39,720 LB Manual Out
Net Weight: 52540 LB
Net Tons: 26.27

BOL: 12215

Origin	Yards	Material	Billing	Quantity
Not Applicable	0.00 YD	SW CONTAMINATED SOIL	26.27	TN

Driver: _____

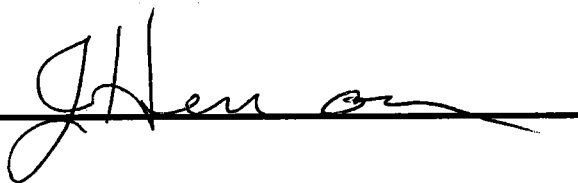

Weighmaster: _____

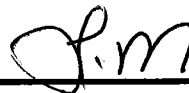

IN - JORDADE OUT - MORENOJ

Indemnification. Customer agrees, by signature above, to indemnify, hold harmless, and defend Republic Services, Inc., its subsidiaries, affiliates, employees, officers and directors from and against any and all liabilities, claims, penalties, forfeitures, suits and the costs and expenses incident thereto, including costs of defense, settlement, and reasonable attorney's fees, which may be incurred, as a result of death or injuries to any person, or damage to any property, contamination of or adverse effects on the environment, caused in whole or in part by the Customer, its employees, or subcontractors in disposing waste at this Facility. In the event Customer delivers Unacceptable Waste (as determined by Republic) Customer agrees to assume all expenses and obligations with the removal and/or resolution of any effects caused by the delivery of such Unacceptable Waste.

Indemnización. Cliente acuerda indemnizar, mantener inmune, y defender Republic Services, Inc., sus subsidiarios, companias, divisiones, empleados, oficiales y directores contra de cualquiera y de todas responsabilidades, demandas, penas, pérdidas, juicios, pleitos y los costos incidente además, incluyendo costos de defensa, de acuerdo judicial, y de honorarios razonables del abogado, que pueden ser incurridos en, o como resultado de, la muerte o herida personal a cualquier persona, o daños a cualquier característica, propiedad, contaminación de la tierra o efectos ilicitos en esta Facilidat, causado entero o en parte por el cliente, sus empleados, o sus subcontratistas en botar basura en esta Facilidat. En el caso que el Cliente entrega, bota, basura (según lo determinado por Republic) en este Establecimiento basura inaceptable en los reglamentos de este Establecimiento, el Cliente se compromete asumir todos los costos y obligaciones con el retiro y/o la resolución de cualquier dano(s) causado por la entrega de tal basura inaceptable.



NON-HAZARDOUS WASTE MANIFEST

MANIFEST # 12215

GENERATOR INFORMATION

Generator Name: Tronox LLC
Address: P.O. Box 55
City: Henderson County: Clark
State: NV Zip: 89009
Site Location (if different): 560 W. Lake Mead
Henderson, NV 89015 (702) 592-7727

CUSTOMER/BILLING INFORMATION

Billing Name: NGE LLC c/o Northgate Environment Management
Address: 300 Frank Ogawa Plaza, Ste 510
City: Oakland County: Alameda
State: CA Zip: 94612

Table with 5 columns: Republic Services Approval #, Description of Waste, Volume/Weight, Expiration Date, Container Type. Row 1: 38251011244, Soil for disposal, 26.27, 12-31-2011, Tractor with Dump Trailer(s).

*Attach Additional Sheet if necessary

I hereby certify that the above-described materials are non-hazardous wastes as defined by 40 CFR 261 or any applicable state law. Further, that the above named materials are properly classified, described, packaged, marked and labeled, and are in proper condition for transportation according to the applicable regulations of the Department of Transportation.

Susan Crowley
Generator/Authorized Agent Name Signature Date Shipped

TRANSPORTER INFORMATION

Transporter Name: Las Vegas Paving DOT # 191949
Address: 4420 S. Decatur Truck Number: 192391
Las Vegas, NV 89103 Phone Number: (702) 353-4355

I certify no hazardous waste or other regulated substance was knowingly introduced to the waste while in my custody. The waste transported in this vehicle is the waste identified above, to the best of my knowledge.

Name of Authorized Agent Signature Date Delivered 10-8-10

DISPOSAL SITE INFORMATION

Site Name: Apex Regional Landfill Phone No. (702) 599-5920
Address: 13550 U.S. Hwy 93 Las Vegas, NV

I hereby acknowledge receipt of the above described materials.
Name (Print or Type) Signature Date Received 10-9-10

81 Environmental Tech
13550 N Highway 93
Las Vegas, NV 89165

Ticket Type: INBOUND INVOICE

Ticket Number: 2130
Date: 10/08/2010
Time In: 11:42 am
Time Out: 12:10 pm

Customer: 001011 - NGE, LLC c/o Northgate Environ Mgmt

Vehicle/Container: Z009877
Contract: Northgate Env. On Site Soils 3825 11
Comment: 3825 10 11244

Gross Weight: 131,120 LB Manual In
Tare Weight: 48,820 LB Manual Out
Net Weight: 82300 LB
Net Tons: 41.15

BOL: 12213

Origin	Yards	Material	Billing	Quantity
Not Applicable	0.00 YD	SW CONTAMINATED SOIL	41.15	TN

Driver: _____

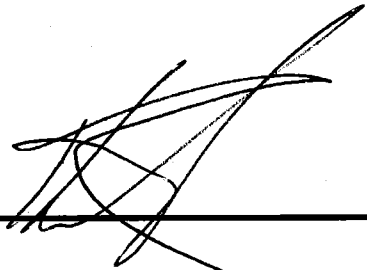

Weighmaster: _____



IN - JORDADE OUT - MORENOJ

Indemnification. Customer agrees, by signature above, to indemnify, hold harmless, and defend Republic Services, Inc., its subsidiaries, affiliates, employees, officers and directors from and against any and all liabilities, claims, penalties, forfeitures, suits and the costs and expenses incident thereto, including costs of defense, settlement, and reasonable attorney's fees, which may be incurred, as a result of death or injuries to any person, or damage to any property, contamination of or adverse effects on the environment, caused in whole or in part by the Customer, its employees, or subcontractors in disposing waste at this Facility. In the event Customer delivers Unacceptable Waste (as determined by Republic) Customer agrees to assume all expenses and obligations with the removal and/or resolution of any effects caused by the delivery of such Unacceptable Waste.

Indemnización. Cliente acuerda indemnizar, mantener inmune, y defender Republic Services, Inc., sus subsidiarios, compañías, divisiones, empleados, oficiales y directores contra de cualquiera y de todas responsabilidades, demandas, penas, pérdidas, juicios, pleitos y los costos incidente además, incluyendo costos de defensa, de acuerdo judicial, y de honorarios razonables del abogado, que pueden ser incurridos en, o como resultado de, la muerte o herida personal a cualquier persona, o daños a cualquier característica, propiedad, contaminación de la tierra o efectos ilícitos en esta Facilidad, causado entero o en parte por el cliente, sus empleados, o sus subcontratistas en botar basura en esta Facilidad. En el caso que el Cliente entrega, bota, basura (según lo determinado por Republic) en este Establecimiento basura inaceptable en los reglamentos de este Establecimiento, el Cliente se compromete asumir todos los costos y obligaciones con el retiro y/o la resolución de cualquier dano(s) causado por la entrega de tal basura inaceptable.



NON-HAZARDOUS WASTE MANIFEST

MANIFEST # 12213

GENERATOR INFORMATION

Generator Name: Tronox LLC
Address: P.O. Box 55
City: Henderson County: Clark
State: NV Zip: 89009
Site Location (if different): 560 W. Lake Mead
Henderson, NV 89015 (702) 592-7727

CUSTOMER/BILLING INFORMATION

Billing Name: NGE LLC c/o Northgate Environment Management
Address: 300 Frank Ogawa Plaza, Ste 510
City: Oakland County: Alameda
State: CA Zip: 94612

Table with 5 columns: Republic Services Approval #, Description of Waste, Volume/Weight, Expiration Date, Container Type. Row 1: 38251011244, Soil for disposal, 41.15, 12-31-2011, Tractor with Dump Trailer(s). Row 2: RZ- #

*Attach Additional Sheet if necessary

I hereby certify that the above-described materials are non-hazardous wastes as defined by 40 CFR 261 or any applicable state law. Further, that the above named materials are properly classified, described, packaged, marked and labeled, and are in proper condition for transportation according to the applicable regulations of the Department of Transportation.

Susan Crowley
Generator/Authorized Agent Name Signature Date Shipped

TRANSPORTER INFORMATION

Transporter Name: Las Vegas Paving DOT # 191949
Address: 4420 S. Decatur Truck Number: 2010
Las Vegas, NV 89103 Phone Number: (702) 353-4355

I certify no hazardous waste or other regulated substance was knowingly introduced to the waste while in my custody. The waste transported in this vehicle is the waste identified above, to the best of my knowledge.

Name of Authorized Agent Signature Date Delivered 10-8-10

DISPOSAL SITE INFORMATION

Site Name: Apex Regional Landfill Phone No. (702) 599-5920
Address: 13550 U.S. Hwy 93 Las Vegas, NV

I hereby acknowledge receipt of the above described materials
Name (Print or Type) Juan Moreno Signature Date Received 10-8-10

81 Environmental Tech
13550 N Highway 93
Las Vegas, NV 89165

Ticket Type: INBOUND INVOICE

Ticket Number: 2131
Date: 10/08/2010
Time In: 11:49 am
Time Out: 12:16 pm

Customer: 001011 - NGE, LLC c/o Northgate Environ Mgmt

Vehicle/Container: 80812P
Contract: Northgate Env. On Site Soils 3825 11
Comment: 3825 10 11244

Gross Weight: 131,800 LB Manual In
Tare Weight: 56,440 LB Manual Out
Net Weight: 75360 LB
Net Tons: 37.68

BOL: 12214

Origin	Yards	Material	Billing Quantity
Not Applicable	0.00 YD	SW CONTAMINATED SOIL	37.68 TN

Driver: _____

Weighmaster: _____

IN - JORDADE OUT - MORENOJ

Indemnification. Customer agrees, by signature above, to indemnify, hold harmless, and defend Republic Services, Inc., its subsidiaries, affiliates, employees, officers and directors from and against any and all liabilities, claims, penalties, forfeitures, suits and the costs and expenses incident thereto, including costs of defense, settlement, and reasonable attorney's fees, which may be incurred, as a result of death or injuries to any person, or damage to any property, contamination of or adverse effects on the environment, caused in whole or in part by the Customer, its employees, or subcontractors in disposing waste at this Facility. In the event Customer delivers Unacceptable Waste (as determined by Republic) Customer agrees to assume all expenses and obligations with the removal and/or resolution of any effects caused by the delivery of such Unacceptable Waste.

Indemnización. Cliente acuerda indemnizar, mantener inmune, y defender Republic Services, Inc., sus subsidiarios, compañías, divisiones, empleados, oficiales y directores contra de cualquiera y de todas responsabilidades, demandas, penas, pérdidas, juicios, pleitos y los costos incidente además, incluyendo costos de defensa, de acuerdo judicial, y de honorarios razonables del abogado, que pueden ser incurridos en, o como resultado de, la muerte o herida personal a cualquier persona, o daños a cualquier característica, propiedad, contaminación de la tierra o efectos ilícitos en esta Facilidad, causado entero o en parte por el cliente, sus empleados, o sus subcontratistas en botar basura en esta Facilidad. En el caso que el Cliente entrega, bota, basura (según lo determinado por Republic) en este Establecimiento basura inaceptable en los reglamentos de este Establecimiento, el Cliente se compromete asumir todos los costos y obligaciones con el retiro y/o la resolución de cualquier dano(s) causado por la entrega de tal basura inaceptable.



NON-HAZARDOUS WASTE MANIFEST

MANIFEST # 12214

GENERATOR INFORMATION

Generator Name: Tronox LLC
Address: P.O. Box 55
City: Henderson County: Clark
State: NV Zip: 89009
Site Location (if different): 560 W. Lake Mead
Henderson, NV 89015 (702) 592-7727

CUSTOMER/BILLING INFORMATION

Billing Name: NGE LLC c/o Northgate Environment Management
Address: 300 Frank Ogawa Plaza, Ste 510
City: Oakland County: Alameda
State: CA Zip: 94612

Table with 5 columns: Republic Services Approval #, Description of Waste, Volume/Weight, Expiration Date, Container Type. Row 1: 38251011244, Soil for disposal, 37.68 TN, 12-31-2011, Tractor with Dump Trailer(s).

*Attach Additional Sheet if necessary

I hereby certify that the above-described materials are non-hazardous wastes as defined by 40 CFR 261 or any applicable state law. Further, that the above named materials are properly classified, described, packaged, marked and labeled, and are in proper condition for transportation according to the applicable regulations of the Department of Transportation.

Susan Crowley (Signature)
Generator/Authorized Agent Name Signature Date Shipped

TRANSPORTER INFORMATION

Transporter Name: Las Vegas Paving DOT # 191949
Address: 4420 S. Decatur Truck Number: 03
Las Vegas, NV 89103 Phone Number: (702) 353-4355

I certify no hazardous waste or other regulated substance was knowingly introduced to the waste while in my custody. The waste transported in this vehicle is the waste identified above, to the best of my knowledge.

(Signature)
Name of Authorized Agent Signature Date Delivered 10-8-10

DISPOSAL SITE INFORMATION

Site Name: Apex Regional Landfill Phone No. (702) 599-5920
Address: 13550 U.S. Hwy 93 Las Vegas, NV

I hereby acknowledge receipt of the above described materials
Juan Moreno (Signature)
Name (Print or Type) Signature Date Received 10-8-10

81 Environmental Tech
13550 N Highway 93
Las Vegas, NV 89165

Ticket Type: INBOUND INVOICE

Ticket Number: 2132
Date: 10/08/2010
Time In: 11:52 am
Time Out: 12:20 pm

Customer: 001011 - NGE, LLC c/o Northgate Environ Mgmt

Vehicle/Container: 72010P
Contract: Northgate Env. On Site Soils 3825 11
Comment: 3825 10 11244

Gross Weight: 129,840 LB Manual In
Tare Weight: 52,440 LB Manual Out
Net Weight: 77400 LB
Net Tons: 38.70

BOL: 12216

Origin	Yards	Material	Billing	Quantity
Not Applicable	0.00 YD	SW CONTAMINATED SOIL	38.70	TN

Driver: _____



Weighmaster: _____



IN - JORDADE OUT - MORENOJ

Indemnification. Customer agrees, by signature above, to indemnify, hold harmless, and defend Republic Services, Inc., its subsidiaries, affiliates, employees, officers and directors from and against any and all liabilities, claims, penalties, forfeitures, suits and the costs and expenses incident thereto, including costs of defense, settlement, and reasonable attorney's fees, which may be incurred, as a result of death or injuries to any person, or damage to any property, contamination of or adverse effects on the environment, caused in whole or in part by the Customer, its employees, or subcontractors in disposing waste at this Facility. In the event Customer delivers Unacceptable Waste (as determined by Republic) Customer agrees to assume all expenses and obligations with the removal and/or resolution of any effects caused by the delivery of such Unacceptable Waste.

Indemnización. Cliente acuerda indemnizar, mantener inmune, y defender Republic Services, Inc., sus subsidiarios, compañías, divisiones, empleados, oficiales y directores contra de cualquiera y de todas responsabilidades, demandas, penas, pérdidas, juicios, pleitos y los costos incidente además, incluyendo costos de defensa, de acuerdo judicial, y de honorarios razonables del abogado, que pueden ser incurridos en, o como resultado de, la muerte o herida personal a cualquier persona, o daños a cualquier característica, propiedad, contaminación de la tierra o efectos ilícitos en esta Facilidad, causado entero o en parte por el cliente, sus empleados, o sus subcontratistas en botar basura en esta Facilidad. En el caso que el Cliente entrega, bota, basura (según lo determinado por Republic) en este Establecimiento basura inaceptable en los reglamentos de este Establecimiento, el Cliente se compromete asumir todos los costos y obligaciones con el retiro y/o la resolución de cualquier dano(s) causado por la entrega de tal basura inaceptable.



NON-HAZARDOUS WASTE MANIFEST

MANIFEST # 12216

GENERATOR INFORMATION

Generator Name: Tronox LLC
Address: P.O. Box 55
City: Henderson County: Clark
State: NV Zip: 89009
Site Location (if different): 560 W. Lake Mead
Henderson, NV 89015 (702) 592-7727

CUSTOMER/BILLING INFORMATION

Billing Name: NGE LLC c/o Northgate Environment Management
Address: 300 Frank Ogawa Plaza, Ste 510
City: Oakland County: Alameda
State: CA Zip: 94612

Table with 5 columns: Republic Services Approval #, Description of Waste, Volume/Weight, Expiration Date, Container Type. Row 1: 38251011244, Soil for disposal, 38.70, 12-31-2011, Tractor with Dump Trailer(s).

*Attach Additional Sheet if necessary

I hereby certify that the above-described materials are non-hazardous wastes as defined by 40 CFR 261 or any applicable state law. Further, that the above named materials are properly classified, described, packaged, marked and labeled, and are in proper condition for transportation according to the applicable regulations of the Department of Transportation.

Susan Crowley
Generator/Authorized Agent Name Signature Date Shipped

TRANSPORTER INFORMATION

Transporter Name: Las Vegas Paving DOT # 191949
Address: 4420 S. Decatur Truck Number: 97
Las Vegas, NV 89103 Phone Number: (702) 353-4355

I certify no hazardous waste or other regulated substance was knowingly introduced to the waste while in my custody. The waste transported in this vehicle is the waste identified above, to the best of my knowledge.

Name of Authorized Agent Signature Date Delivered 10-8-10

DISPOSAL SITE INFORMATION

Site Name: Apex Regional Landfill Phone No. (702) 599-5920
Address: 13550 U.S. Hwy 93 Las Vegas, NV

I hereby acknowledge receipt of the above described materials.
Juan Moreno Signature Date Received 10-8-10

81 Environmental Tech
13550 N Highway 93
Las Vegas, NV 89165

Ticket Type: INBOUND INVOICE

Ticket Number: 2133
Date: 10/08/2010
Time In: 11:58 am
Time Out: 12:22 pm

Customer: 001011 - NGE, LLC c/o Northgate Environ Mgmt

Vehicle/Container: 85156P
Contract: Northgate Env. On Site Soils 3825 10
Comment: 3825 10 11244

Gross Weight: 132,260 LB Manual In
Tare Weight: 57,120 LB Manual Out
Net Weight: 75140 LB
Net Tons: 37.57

BOL: 12219

Origin	Yards	Material	Billing	Quantity
Not Applicable	0.00 YD	SW CONTAMINATED SOIL	37.57	TN

Driver: 

Weighmaster: 

IN - JORDADE OUT - MORENOJ

Indemnification. Customer agrees, by signature above, to indemnify, hold harmless, and defend Republic Services, Inc., its subsidiaries, affiliates, employees, officers and directors from and against any and all liabilities, claims, penalties, forfeitures, suits and the costs and expenses incident thereto, including costs of defense, settlement, and reasonable attorney's fees, which may be incurred, as a result of death or injuries to any person, or damage to any property, contamination of or adverse effects on the environment, caused in whole or in part by the Customer, its employees, or subcontractors in disposing waste at this Facility. In the event Customer delivers Unacceptable Waste (as determined by Republic) Customer agrees to assume all expenses and obligations with the removal and/or resolution of any effects caused by the delivery of such Unacceptable Waste.

Indemnización. Cliente acuerda indemnizar, mantener inmune, y defender Republic Services, Inc., sus subsidiarios, compañías, divisiones, empleados, oficiales y directores contra de cualquiera y de todas responsabilidades, demandas, penas, pérdidas, juicios, pleitos y los costos incidente además, incluyendo costos de defensa, de acuerdo judicial, y de honorarios razonables del abogado, que pueden ser incurridos en, o como resultado de, la muerte o herida personal a cualquier persona, o daños a cualquier característica, propiedad, contaminación de la tierra o efectos ilícitos en esta Facilidad, causado entero o en parte por el cliente, sus empleados, o sus subcontratistas en botar basura en esta Facilidad. En el caso que el Cliente entrega, bota, basura (según lo determinado por Republic) en este Establecimiento basura inaceptable en los reglamentos de este Establecimiento, el Cliente se compromete asumir todos los costos y obligaciones con el retiro y/o la resolución de cualquier dano(s) causado por la entrega de tal basura inaceptable.



NON-HAZARDOUS WASTE MANIFEST

MANIFEST # 12219

GENERATOR INFORMATION

Generator Name: Tronox LLC

Address: P.O. Box 55

City: Henderson County: Clark

State: NV Zip: 89009

Site Location (if different): 560 W. Lake Mead

Henderson, NV 89015 (702) 592-7727

CUSTOMER/BILLING INFORMATION

Billing Name: NGE LLC c/o Northgate Environment Management

Address: 300 Frank Ogawa Plaza, Ste 510

City: Oakland County: Alameda

State: CA Zip: 94612

Republic Services Approval #	Description of Waste	Volume/Weight	Expiration Date	Container Type
38251011244	Soil for disposal		12-31-2011	Tractor with Dump Trailer(s)
	RZ- #	37.57		

*Attach Additional Sheet if necessary

I hereby certify that the above-described materials are non-hazardous wastes as defined by 40 CFR 261 or any applicable state law. Further, that the above named materials are properly classified, described, packaged, marked and labeled, and are in proper condition for transportation according to the applicable regulations of the Department of Transportation.

Susan Crowley (Signature) Generator/Authorized Agent Name Signature Date Shipped

TRANSPORTER INFORMATION

Transporter Name: Las Vegas Paving

DOT # 191949

Address: 4420 S. Decatur

Truck Number: 44

Las Vegas, NV 89103

Phone Number: (702) 353-4355

I certify no hazardous waste or other regulated substance was knowingly introduced to the waste while in my custody. The waste transported in this vehicle is the waste identified above, to the best of my knowledge.

Name of Authorized Agent (Signature) Date Delivered 10-8-10

DISPOSAL SITE INFORMATION

Site Name: Apex Regional Landfill

Phone No. (702) 599-5920

Address: 13550 U.S. Hwy 93 Las Vegas, NV

I hereby acknowledge receipt of the above described materials Juan Moreno (Signature) Date Received 10-8-10

81 Environmental Tech
13550 N Highway 93
Las Vegas, NV 89165

Ticket Type: INBOUND INVOICE

Ticket Number: 2134
Date: 10/08/2010
Time In: 11:54 am
Time Out: 12:24 pm

Customer: 001011 - NGE, LLC c/o Northgate Environ Mgmt

Vehicle/Container: 85887P
Contract: Northgate Env. On Site Soils 3825 11
Comment: 3825 10 11244

Gross Weight: 128,920 LB Manual In
Tare Weight: 50,660 LB Manual Out
Net Weight: 78260 LB
Net Tons: 39.13

BOL: 12217

Origin	Yards	Material	Billing Quantity
Not Applicable	0.00 YD	SW CONTAMINATED SOIL	39.13 TN

Driver:

Miguel Ramos

Weighmaster:

J.M.

IN - JORDADE OUT - MORENOJ

Indemnification. Customer agrees, by signature above, to indemnify, hold harmless, and defend Republic Services, Inc., its subsidiaries, affiliates, employees, officers and directors from and against any and all liabilities, claims, penalties, forfeitures, suits and the costs and expenses incident thereto, including costs of defense, settlement, and reasonable attorney's fees, which may be incurred, as a result of death or injuries to any person, or damage to any property, contamination of or adverse effects on the environment, caused in whole or in part by the Customer, its employees, or subcontractors in disposing waste at this Facility. In the event Customer delivers Unacceptable Waste (as determined by Republic) Customer agrees to assume all expenses and obligations with the removal and/or resolution of any effects caused by the delivery of such Unacceptable Waste.

Indemnización. Cliente acuerda indemnizar, mantener inmune, y defender Republic Services, Inc., sus subsidiarios, companias, divisiones, empleados, oficiales y directores contra de cualquiera y de todas responsabilidades, demandas, penas, pérdidas, juicios, pleitos y los costos incidente además, incluyendo costos de defensa, de acuerdo judicial, y de honorarios razonables del abogado, que pueden ser incurridos en, o como resultado de, la muerte o herida personal a cualquier persona, o daños a cualquier característica, propiedad, contaminación de la tierra o efectos ilicitos en esta Facilidad, causado entero o en parte por el cliente, sus empleados, o sus subcontratistas en botar basura en esta Facilidad. En el caso que el Cliente entrega, bota, basura (según lo determinado por Republic) en este Establecimiento basura inaceptable en los reglamentos de este Establecimiento, el Cliente se compromete asumir todos los costos y obligaciones con el retiro y/o la resolución de cualquier dano(s) causado por la entrega de tal basura inaceptable.



NON-HAZARDOUS WASTE MANIFEST

MANIFEST # 12217

GENERATOR INFORMATION

Generator Name: Tronox LLC

Address: P.O. Box 55

City: Henderson County: Clark

State: NV Zip: 89009

Site Location (if different): 560 W. Lake Mead
Henderson, NV 89015 (702) 592-7727

CUSTOMER/BILLING INFORMATION

Billing Name: NGE LLC c/o Northgate Environment Management

Address: 300 Frank Ogawa Plaza, Ste 510

City: Oakland County: Alameda

State: CA Zip: 94612

Table with 5 columns: Republic Services Approval #, Description of Waste, Volume/Weight, Expiration Date, Container Type. Row 1: 38251011244, Soil for disposal, 39.13 TN, 12-31-2011, Tractor with Dump Trailer(s).

*Attach Additional Sheet if necessary

I hereby certify that the above-described materials are non-hazardous wastes as defined by 40 CFR 261 or any applicable state law. Further, that the above named materials are properly classified, described, packaged, marked and labeled, and are in proper condition for transportation according to the applicable regulations of the Department of Transportation.

Susan Crowley (Name), Signature (Handwritten), Date Shipped

TRANSPORTER INFORMATION

Transporter Name: Las Vegas Paving

DOT # 191949

Address: 4420 S. Decatur

Truck Number: R01

Las Vegas, NV 89103

Phone Number: (702) 353-4355

I certify no hazardous waste or other regulated substance was knowingly introduced to the waste while in my custody. The waste transported in this vehicle is the waste identified above, to the best of my knowledge.

Miguel Ramos (Name), Signature (Handwritten), Date Delivered: 10-8-10

DISPOSAL SITE INFORMATION

Site Name: Apex Regional Landfill

Phone No. (702) 599-5920

Address: 13550 U.S. Hwy 93 Las Vegas, NV

Juan Moreno (Name), Signature (Handwritten), Date Received: 10-8-10

81 Environmental Tech
13550 N Highway 93
Las Vegas, NV 89165

Ticket Type: INBOUND INVOICE

Ticket Number: 2136
Date: 10/08/2010
Time In: 12:00 pm
Time Out: 12:29 pm

Customer: 001011 - NGE, LLC c/o Northgate Environ Mgmt

Vehicle/Container: 71893P
Contract: Northgate Env. On Site Soils 3825 11
Comment: 3825 10 11244

Gross Weight: 127,920 LB Manual In
Tare Weight: 53,320 LB Manual Out
Net Weight: 74600 LB
Net Tons: 37.30

BOL: 12218

Origin	Yards	Material	Billing	Quantity
Not Applicable	0.00 YD	SW CONTAMINATED SOIL	37.30	TN

Driver: _____

Weighmaster: _____

IN - JORDADE OUT - MORENOJ

Indemnification. Customer agrees, by signature above, to indemnify, hold harmless, and defend Republic Services, Inc., its subsidiaries, affiliates, employees, officers and directors from and against any and all liabilities, claims, penalties, forfeitures, suits and the costs and expenses incident thereto, including costs of defense, settlement, and reasonable attorney's fees, which may be incurred, as a result of death or injuries to any person, or damage to any property, contamination of or adverse effects on the environment, caused in whole or in part by the Customer, its employees, or subcontractors in disposing waste at this Facility. In the event Customer delivers Unacceptable Waste (as determined by Republic) Customer agrees to assume all expenses and obligations with the removal and/or resolution of any effects caused by the delivery of such Unacceptable Waste.

Indemnización. Cliente acuerda indemnizar, mantener inmune, y defender Republic Services, Inc., sus subsidiarios, compañías, divisiones, empleados, oficiales y directores contra de cualquiera y de todas responsabilidades, demandas, penas, pérdidas, juicios, pleitos y los costos incidente además, incluyendo costos de defensa, de acuerdo judicial, y de honorarios razonables del abogado, que pueden ser incurridos en, o como resultado de, la muerte o herida personal a cualquier persona, o daños a cualquier característica, propiedad, contaminación de la tierra o efectos ilícitos en esta Facilidad, causado entero o en parte por el cliente, sus empleados, o sus subcontratistas en botar basura en esta Facilidad. En el caso que el Cliente entrega, bota, basura (según lo determinado por Republic) en este Establecimiento basura inaceptable en los reglamentos de este Establecimiento, el Cliente se compromete asumir todos los costos y obligaciones con el retiro y/o la resolución de cualquier dano(s) causado por la entrega de tal basura inaceptable.



NON-HAZARDOUS WASTE MANIFEST

MANIFEST # 12218

GENERATOR INFORMATION

Generator Name: Tronox LLC

Address: P.O. Box 55

City: Henderson County: Clark

State: NV Zip: 89009

Site Location (if different): 560 W. Lake Mead

Henderson, NV 89015 (702) 592-7727

CUSTOMER/BILLING INFORMATION

Billing Name: NGE LLC c/o Northgate Environment Management

Address: 300 Frank Ogawa Plaza, Ste 510

City: Oakland County: Alameda

State: CA Zip: 94612

Republic Services Approval #	Description of Waste	Volume/Weight	Expiration Date	Container Type
38251011244	Soil for disposal		12-31-2011	Tractor with Dump Trailer(s)
	RZ- _____ # _____	37.30		

*Attach Additional Sheet if necessary

I hereby certify that the above-described materials are non-hazardous wastes as defined by 40 CFR 261 or any applicable state law. Further, that the above named materials are properly classified, described, packaged, marked and labeled, and are in proper condition for transportation according to the applicable regulations of the Department of Transportation.

Susan Crowley

Susan Crowley

Generator/Authorized Agent Name

Signature

Date Shipped

TRANSPORTER INFORMATION

Transporter Name: Las Vegas Paving

DOT # 191949

Address: 4420 S. Decatur

Truck Number: JH 7

Las Vegas, NV 89103

Phone Number: (702) 353-4355

I certify no hazardous waste or other regulated substance was knowingly introduced to the waste while in my custody. The waste transported in this vehicle is the waste identified above, to the best of my knowledge.

Name of Authorized Agent

Signature

Date Delivered 10-8-10

DISPOSAL SITE INFORMATION

Site Name: Apex Regional Landfill

Phone No. (702) 599-5920

Address: 13550 U.S. Hwy 93 Las Vegas, NV

I hereby acknowledge receipt of the above described materials

Name (Print or Type)

Signature Juan Moreno

Date Received 10-8-10

81 Environmental Tech
13550 N Highway 93
Las Vegas, NV 89165

Ticket Type: INBOUND INVOICE

Ticket Number: 2137
Date: 10/08/2010
Time In: 12:22 pm
Time Out: 12:49 pm

Customer: 001011 - NGE, LLC c/o Northgate Environ Mgmt

Vehicle/Container: 66954P
Contract: Northgate Env. On Site Soils 3825 10
Comment: 3825 10 11244

Gross Weight: 130,020 LB Manual In
Tare Weight: 53,260 LB Manual Out
Net Weight: 76760 LB
Net Tons: 38.38

BOL: 12220

Origin	Yards	Material	Billing Quantity
Not Applicable	0.00 YD	SW CONTAMINATED SOIL	38.38 TN

Driver: _____



Weighmaster: _____



IN - JORDADE OUT - MORENOJ

Indemnification. Customer agrees, by signature above, to indemnify, hold harmless, and defend Republic Services, Inc., its subsidiaries, affiliates, employees, officers and directors from and against any and all liabilities, claims, penalties, forfeitures, suits and the costs and expenses incident thereto, including costs of defense, settlement, and reasonable attorney's fees, which may be incurred, as a result of death or injuries to any person, or damage to any property, contamination of or adverse effects on the environment, caused in whole or in part by the Customer, its employees, or subcontractors in disposing waste at this Facility. In the event Customer delivers Unacceptable Waste (as determined by Republic) Customer agrees to assume all expenses and obligations with the removal and/or resolution of any effects caused by the delivery of such Unacceptable Waste.

Indemnización. Cliente acuerda indemnizar, mantener inmune, y defender Republic Services, Inc., sus subsidiarios, compañías, divisiones, empleados, oficiales y directores contra de cualquiera y de todas responsabilidades, demandas, penas, pérdidas, juicios, pleitos y los costos incidente además, incluyendo costos de defensa, de acuerdo judicial, y de honorarios razonables del abogado, que pueden ser incurridos en, o como resultado de, la muerte o herida personal a cualquier persona, o daños a cualquier característica, propiedad, contaminación de la tierra o efectos ilícitos en esta Facilidad, causado entero o en parte por el cliente, sus empleados, o sus subcontratistas en botar basura en esta Facilidad. En el caso que el Cliente entrega, bota, basura (según lo determinado por Republic) en este Establecimiento basura inaceptable en los reglamentos de este Establecimiento, el Cliente se compromete asumir todos los costos y obligaciones con el retiro y/o la resolución de cualquier dano(s) causado por la entrega de tal basura inaceptable.



NON-HAZARDOUS WASTE MANIFEST

MANIFEST # 12220

GENERATOR INFORMATION

Generator Name: Tronox LLCAddress: P.O. Box 55City: Henderson County: ClarkState: NV Zip: 89009Site Location (if different): 560 W. Lake MeadHenderson, NV 89015 (702) 592-7727

CUSTOMER/BILLING INFORMATION

Billing Name: NGE LLC c/o Northgate Environment ManagementAddress: 300 Frank Ogawa Plaza, Ste 510City: Oakland County: AlamedaState: CA Zip: 94612

Republic Services Approval #	Description of Waste	Volume/Weight	Expiration Date	Container Type
38251011244	Soil for disposal		12-31-2011	Tractor with Dump Trailer(s)
	RZ- #	38.38 TW		

*Attach Additional Sheet if necessary

I hereby certify that the above-described materials are non-hazardous wastes as defined by 40 CFR 261 or any applicable state law. Further, that the above named materials are properly classified, described, packaged, marked and labeled, and are in proper condition for transportation according to the applicable regulations of the Department of Transportation.

Susan Crowley Tom Crowley _____
 Generator/Authorized Agent Name Signature Date Shipped

TRANSPORTER INFORMATION

Transporter Name: Las Vegas PavingDOT # 191949Address: 4420 S. DecaturTruck Number: 55Las Vegas, NV 89103Phone Number: (702) 353-4355

I certify no hazardous waste or other regulated substance was knowingly introduced to the waste while in my custody. The waste transported in this vehicle is the waste identified above, to the best of my knowledge.

_____ 10.8.10
 Name of Authorized Agent Signature Date Delivered

DISPOSAL SITE INFORMATION

Site Name: Apex Regional LandfillPhone No. (702) 599-5920Address: 13550 U.S. Hwy 93 Las Vegas, NV

I hereby acknowledge receipt of the above described materials
Juan Moreno Juan Moreno 10.8.10
 Name (Print or Type) Signature Date Received

81 Environmental Tech
13550 N Highway 93
Las Vegas, NV 89165

Ticket Type: INBOUND INVOICE

Ticket Number: 2138
Date: 10/08/2010
Time In: 12:23 pm
Time Out: 12:51 pm

Customer: 001011 - NGE, LLC c/o Northgate Environ Mgmt

Vehicle/Container: 82515P
Contract: Northgate Env. On Site Soils 3825 11
Comment: 3525 10 11244

Gross Weight: 122,620 LB Manual In
Tare Weight: 53,180 LB Manual Out
Net Weight: 69440 LB
Net Tons: 34.72

BOL: 12221

Origin	Yards	Material	Billing	Quantity
Not Applicable	0.00 YD	SW CONTAMINATED SOIL	34.72	TN

Driver:

SL Weir 144

Weighmaster:

J.M.

IN - JORDADE OUT - MORENOJ

Indemnification. Customer agrees, by signature above, to indemnify, hold harmless, and defend Republic Services, Inc., its subsidiaries, affiliates, employees, officers and directors from and against any and all liabilities, claims, penalties, forfeitures, suits and the costs and expenses incident thereto, including costs of defense, settlement, and reasonable attorney's fees, which may be incurred, as a result of death or injuries to any person, or damage to any property, contamination of or adverse effects on the environment, caused in whole or in part by the Customer, its employees, or subcontractors in disposing waste at this Facility. In the event Customer delivers Unacceptable Waste (as determined by Republic) Customer agrees to assume all expenses and obligations with the removal and/or resolution of any effects caused by the delivery of such Unacceptable Waste.

Indemnización. Cliente acuerda indemnizar, mantener inmune, y defender Republic Services, Inc., sus subsidiarios, compañías, divisiones, empleados, oficiales y directores contra de cualquiera y de todas responsabilidades, demandas, penas, pérdidas, juicios, pleitos y los costos incidente además, incluyendo costos de defensa, de acuerdo judicial, y de honorarios razonables del abogado, que pueden ser incurridos en, o como resultado de, la muerte o herida personal a cualquier persona, o daños a cualquier característica, propiedad, contaminación de la tierra o efectos ilícitos en esta Facilidad, causado entero o en parte por el cliente, sus empleados, o sus subcontratistas en botar basura en esta Facilidad. En el caso que el Cliente entrega, bota, basura (según lo determinado por Republic) en este Establecimiento basura inaceptable en los reglamentos de este Establecimiento, el Cliente se compromete asumir todos los costos y obligaciones con el retiro y/o la resolución de cualquier dano(s) causado por la entrega de tal basura inaceptable.



NON-HAZARDOUS WASTE MANIFEST

MANIFEST # 12221

GENERATOR INFORMATION

Generator Name: Tronox LLC
Address: P.O. Box 55
City: Henderson County: Clark
State: NV Zip: 89009
Site Location (if different): 560 W. Lake Mead
Henderson, NV 89015 (702) 592-7727

CUSTOMER/BILLING INFORMATION

Billing Name: NGE LLC c/o Northgate Environment Management
Address: 300 Frank Ogawa Plaza, Ste 510
City: Oakland County: Alameda
State: CA Zip: 94612

Table with 5 columns: Republic Services Approval #, Description of Waste, Volume/Weight, Expiration Date, Container Type. Row 1: 38251011244, Soil for disposal, 34.72, 12-31-2011, Tractor with Dump Trailer(s).

*Attach Additional Sheet if necessary

I hereby certify that the above-described materials are non-hazardous wastes as defined by 40 CFR 261 or any applicable state law. Further, that the above named materials are properly classified, described, packaged, marked and labeled, and are in proper condition for transportation according to the applicable regulations of the Department of Transportation.

Susan Crowley (Signature)
Generator/Authorized Agent Name Signature Date Shipped

TRANSPORTER INFORMATION

Transporter Name: Las Vegas Paving DOT # 191949
Address: 4420 S. Decatur Truck Number: 144
Las Vegas, NV 89103 Phone Number: (702) 353-4355

I certify no hazardous waste or other regulated substance was knowingly introduced to the waste while in my custody. The waste transported in this vehicle is the waste identified above, to the best of my knowledge.

JL Wood 144 (Signature) 10.8.10 (Date)
Name of Authorized Agent Signature Date Delivered

DISPOSAL SITE INFORMATION

Site Name: Apex Regional Landfill Phone No. (702) 599-5920
Address: 13550 U.S. Hwy 93 Las Vegas, NV

Juan Moreno (Signature) 10.8.10 (Date)
I hereby acknowledge receipt of the above described materials
Name (Print or Type) Signature Date Received

81 Environmental Tech
13550 N Highway 93
Las Vegas, NV 89165

Ticket Type: INBOUND INVOICE

Ticket Number: 2139
Date: 10/08/2010
Time In: 1:03 pm
Time Out: 1:03 pm

Customer: 001011 - NGE, LLC c/o Northgate Environ Mgmt

Vehicle/Container: 73083P
Contract: Northgate Env. On Site Soils 3825 11
Comment: 3825 10 11244

Gross Weight: 146,400 LB Manual In
Tare Weight: 57,720 LB Manual Out
Net Weight: 88680 LB
Net Tons: 44.34

BOL: 12222

Origin	Yards	Material	Billing Quantity
Not Applicable	0.00 YD	SW CONTAMINATED SOIL	44.34 TN

Driver: _____

Weighmaster: _____

MORENOJ

Indemnification. Customer agrees, by signature above, to indemnify, hold harmless, and defend Republic Services, Inc., its subsidiaries, affiliates, employees, officers and directors from and against any and all liabilities, claims, penalties, forfeitures, suits and the costs and expenses incident thereto, including costs of defense, settlement, and reasonable attorney's fees, which may be incurred, as a result of death or injuries to any person, or damage to any property, contamination of or adverse effects on the environment, caused in whole or in part by the Customer, its employees, or subcontractors in disposing waste at this Facility. In the event Customer delivers Unacceptable Waste (as determined by Republic) Customer agrees to assume all expenses and obligations with the removal and/or resolution of any effects caused by the delivery of such Unacceptable Waste.

Indemnización. Cliente acuerda indemnizar, mantener inmune, y defender Republic Services, Inc., sus subsidiarios, compañías, divisiones, empleados, oficiales y directores contra de cualquiera y de todas responsabilidades, demandas, penas, pérdidas, juicios, pleitos y los costos incidente además, incluyendo costos de defensa, de acuerdo judicial, y de honorarios razonables del abogado, que pueden ser incurridos en, o como resultado de, la muerte o herida personal a cualquier persona, o daños a cualquier característica, propiedad, contaminación de la tierra o efectos ilícitos en esta Facilidad, causado entero o en parte por el cliente, sus empleados, o sus subcontratistas en botar basura en esta Facilidad. En el caso que el Cliente entrega, bota, basura (según lo determinado por Republic) en este Establecimiento basura inaceptable en los reglamentos de este Establecimiento, el Cliente se compromete asumir todos los costos y obligaciones con el retiro y/o la resolución de cualquier dano(s) causado por la entrega de tal basura inaceptable.



NON-HAZARDOUS WASTE MANIFEST

MANIFEST # 12222

GENERATOR INFORMATION

Generator Name: Tronox LLC

Address: P.O. Box 55

City: Henderson County: Clark

State: NV Zip: 89009

Site Location (if different): 560 W. Lake Mead

Henderson, NV 89015 (702) 592-7727

CUSTOMER/BILLING INFORMATION

Billing Name: NGE LLC c/o Northgate Environment Management

Address: 300 Frank Ogawa Plaza, Ste 510

City: Oakland County: Alameda

State: CA Zip: 94612

Republic Services Approval #	Description of Waste	Volume/Weight	Expiration Date	Container Type
38251011244	Soil for disposal		12-31-2011	Tractor with Dump Trailer(s)
	RZ- _____ # _____	4434		

*Attach Additional Sheet if necessary

I hereby certify that the above-described materials are non-hazardous wastes as defined by 40 CFR 261 or any applicable state law. Further, that the above named materials are properly classified, described, packaged, marked and labeled, and are in proper condition for transportation according to the applicable regulations of the Department of Transportation.

Susan Crowley Generator/Authorized Agent Name Signature Date Shipped

TRANSPORTER INFORMATION

Transporter Name: Las Vegas Paving

DOT # 191949

Address: 4420 S. Decatur

Truck Number: 35

Las Vegas, NV 89103

Phone Number: (702) 353-4355

I certify no hazardous waste or other regulated substance was knowingly introduced to the waste while in my custody. The waste transported in this vehicle is the waste identified above, to the best of my knowledge.

Name of Authorized Agent Signature Date Delivered

DISPOSAL SITE INFORMATION

Site Name: Apex Regional Landfill

Phone No. (702) 599-5920

Address: 13550 U.S. Hwy 93 Las Vegas, NV

I hereby acknowledge receipt of the above described materials Name (Print or Type) Signature Date Received

81 Environmental Tech
13550 N Highway 93
Las Vegas, NV 89165

Ticket Type: INBOUND INVOICE

Ticket Number: 2140
Date: 10/08/2010
Time In: 12:36 pm
Time Out: 1:05 pm

Customer: 001011 - NGE, LLC c/o Northgate Environ Mgmt

Vehicle/Container: 84893P
Contract: Northgate Env. On Site Soils 3825 11
Comment: 3825 10 11244

Gross Weight: 129,460 LB Manual In
Tare Weight: 53,800 LB Manual Out
Net Weight: 75660 LB
Net Tons: 37.83

BOL: 12223

Origin	Yards	Material	Billing Quantity
Not Applicable	0.00 YD	SW CONTAMINATED SOIL	37.83 TN

Driver: _____

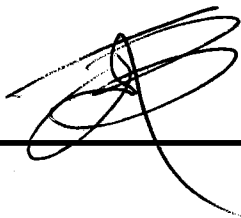

Weighmaster: _____



IN - JORDADE OUT - MORENOJ

Indemnification. Customer agrees, by signature above, to indemnify, hold harmless, and defend Republic Services, Inc., its subsidiaries, affiliates, employees, officers and directors from and against any and all liabilities, claims, penalties, forfeitures, suits and the costs and expenses incident thereto, including costs of defense, settlement, and reasonable attorney's fees, which may be incurred, as a result of death or injuries to any person, or damage to any property, contamination of or adverse effects on the environment, caused in whole or in part by the Customer, its employees, or subcontractors in disposing waste at this Facility. In the event Customer delivers Unacceptable Waste (as determined by Republic) Customer agrees to assume all expenses and obligations with the removal and/or resolution of any effects caused by the delivery of such Unacceptable Waste.

Indemnización. Cliente acuerda indemnizar, mantener inmune, y defender Republic Services, Inc., sus subsidiarios, compañías, divisiones, empleados, oficiales y directores contra de cualquiera y de todas responsabilidades, demandas, penas, pérdidas, juicios, pleitos y los costos incidente además, incluyendo costos de defensa, de acuerdo judicial, y de honorarios razonables del abogado, que pueden ser incurridos en, o como resultado de, la muerte o herida personal a cualquier persona, o daños a cualquier característica, propiedad, contaminación de la tierra o efectos ilícitos en esta Facilidad, causado entero o en parte por el cliente, sus empleados, o sus subcontratistas en botar basura en esta Facilidad. En el caso que el Cliente entrega, bota, basura (según lo determinado por Republic) en este Establecimiento basura inaceptable en los reglamentos de este Establecimiento, el Cliente se compromete asumir todos los costos y obligaciones con el retiro y/o la resolución de cualquier dano(s) causado por la entrega de tal basura inaceptable.



NON-HAZARDOUS WASTE MANIFEST

MANIFEST # 12223

GENERATOR INFORMATION

Generator Name: Tronox LLC

Address: P.O. Box 55

City: Henderson County: Clark

State: NV Zip: 89009

Site Location (if different): 560 W. Lake Mead

Henderson, NV 89015 (702) 592-7727

CUSTOMER/BILLING INFORMATION

Billing Name: NGE LLC c/o Northgate Environment Management

Address: 300 Frank Ogawa Plaza, Ste 510

City: Oakland County: Alameda

State: CA Zip: 94612

Republic Services Approval #	Description of Waste	Volume/Weight	Expiration Date	Container Type
38251011244	Soil for disposal		12-31-2011	Tractor with Dump Trailer(s)
	RZ- #	3783 TN		

*Attach Additional Sheet if necessary

I hereby certify that the above-described materials are non-hazardous wastes as defined by 40 CFR 261 or any applicable state law. Further, that the above named materials are properly classified, described, packaged, marked and labeled, and are in proper condition for transportation according to the applicable regulations of the Department of Transportation.

Susan Crowley Generator/Authorized Agent Name Signature Date Shipped

TRANSPORTER INFORMATION

Transporter Name: Las Vegas Paving

DOT # 191949

Address: 4420 S. Decatur

Truck Number: 303

Las Vegas, NV 89103

Phone Number: (702) 353-4355

I certify no hazardous waste or other regulated substance was knowingly introduced to the waste while in my custody. The waste transported in this vehicle is the waste identified above, to the best of my knowledge.

Name of Authorized Agent Signature Date Delivered 10-8-10

DISPOSAL SITE INFORMATION

Site Name: Apex Regional Landfill

Phone No. (702) 599-5920

Address: 13550 U.S. Hwy 93 Las Vegas, NV

I hereby acknowledge receipt of the above described materials Name (Print or Type) Signature Date Received 10-8-10

81 Environmental Tech
13550 N Highway 93
Las Vegas, NV 89165

Ticket Type: INBOUND INVOICE

Ticket Number: 2141
Date: 10/08/2010
Time In: 12:39 pm
Time Out: 1:06 pm

Customer: 001011 - NGE, LLC c/o Northgate Environ Mgmt

Vehicle/Container: 81495P
Contract: Northgate Env. On Site Soils 3825 10
Comment: 3825 10 11244

Gross Weight: 114,240 LB Manual In
Tare Weight: 51,440 LB Manual Out
Net Weight: 62800 LB
Net Tons: 31.40

BOL: 12224

Origin	Yards	Material	Billing Quantity
Not Applicable	0.00 YD	SW CONTAMINATED SOIL	31.40 TN

Driver: _____



Weighmaster: _____

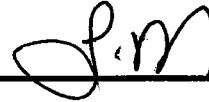

IN - JORDADE OUT - MORENOJ

Indemnification. Customer agrees, by signature above, to indemnify, hold harmless, and defend Republic Services, Inc., its subsidiaries, affiliates, employees, officers and directors from and against any and all liabilities, claims, penalties, forfeitures, suits and the costs and expenses incident thereto, including costs of defense, settlement, and reasonable attorney's fees, which may be incurred, as a result of death or injuries to any person, or damage to any property, contamination of or adverse effects on the environment, caused in whole or in part by the Customer, its employees, or subcontractors in disposing waste at this Facility. In the event Customer delivers Unacceptable Waste (as determined by Republic) Customer agrees to assume all expenses and obligations with the removal and/or resolution of any effects caused by the delivery of such Unacceptable Waste.

Indemnización. Cliente acuerda indemnizar, mantener inmune, y defender Republic Services, Inc., sus subsidiarios, compañías, divisiones, empleados, oficiales y directores contra de cualquiera y de todas responsabilidades, demandas, penas, pérdidas, juicios, pleitos y los costos incidente además, incluyendo costos de defensa, de acuerdo judicial, y de honorarios razonables del abogado, que pueden ser incurridos en, o como resultado de, la muerte o herida personal a cualquier persona, o daños a cualquier característica, propiedad, contaminación de la tierra o efectos ilícitos en esta Facilidad, causado entero o en parte por el cliente, sus empleados, o sus subcontratistas en botar basura en esta Facilidad. En el caso que el Cliente entrega, bota, basura (según lo determinado por Republic) en este Establecimiento basura inaceptable en los reglamentos de este Establecimiento, el Cliente se compromete asumir todos los costos y obligaciones con el retiro y/o la resolución de cualquier dano(s) causado por la entrega de tal basura inaceptable.



NON-HAZARDOUS WASTE MANIFEST

MANIFEST # 12224

GENERATOR INFORMATION

Generator Name: Tronox LLC
Address: P.O. Box 55
City: Henderson County: Clark
State: NV Zip: 89009
Site Location (if different): 560 W. Lake Mead
Henderson, NV 89015 (702) 592-7727

CUSTOMER/BILLING INFORMATION

Billing Name: NGE LLC c/o Northgate Environment Management
Address: 300 Frank Ogawa Plaza, Ste 510
City: Oakland County: Alameda
State: CA Zip: 94612

Table with 5 columns: Republic Services Approval #, Description of Waste, Volume/Weight, Expiration Date, Container Type. Row 1: 38251011244, Soil for disposal, 31.40, 12-31-2011, Tractor with Dump Trailer(s).

*Attach Additional Sheet if necessary

I hereby certify that the above-described materials are non-hazardous wastes as defined by 40 CFR 261 or any applicable state law. Further, that the above named materials are properly classified, described, packaged, marked and labeled, and are in proper condition for transportation according to the applicable regulations of the Department of Transportation.

Susan Crowley (Signature)
Generator/Authorized Agent Name Signature Date Shipped

TRANSPORTER INFORMATION

Transporter Name: Las Vegas Paving DOT # 191949
Address: 4420 S. Decatur Truck Number: 175
Las Vegas, NV 89103 Phone Number: (702) 353-4355

I certify no hazardous waste or other regulated substance was knowingly introduced to the waste while in my custody. The waste transported in this vehicle is the waste identified above, to the best of my knowledge.

Andrew Walker (Signature)
Name of Authorized Agent Signature Date Delivered 10-8-10

DISPOSAL SITE INFORMATION

Site Name: Apex Regional Landfill Phone No. (702) 599-5920
Address: 13550 U.S. Hwy 93 Las Vegas, NV

I hereby acknowledge receipt of the above described materials
Name (Print or Type) Signature Date Received 10-8-10

81 Environmental Tech
13550 N Highway 93
Las Vegas, NV 89165

Ticket Type: INBOUND INVOICE

Ticket Number: 2142
Date: 10/08/2010
Time In: 12:43 pm
Time Out: 1:13 pm

Customer: 001011 - NGE, LLC c/o Northgate Environ Mgmt

Vehicle/Container: 81494P
Contract: Northgate Env. On Site Soils 3825 1
Comment: 3825 10 11244

Gross Weight: 114,760 LB Manual In
Tare Weight: 51,200 LB Manual Out
Net Weight: 63560 LB
Net Tons: 31.78

BOL: 12225

Origin	Yards	Material	Billing	Quantity
Not Applicable	0.00 YD	SW CONTAMINATED SOIL	31.78	TN

Driver: _____

Weighmaster: _____

IN - JORDADE OUT - MORENOJ

Indemnification. Customer agrees, by signature above, to indemnify, hold harmless, and defend Republic Services, Inc., its subsidiaries, affiliates, employees, officers and directors from and against any and all liabilities, claims, penalties, forfeitures, suits and the costs and expenses incident thereto, including costs of defense, settlement, and reasonable attorney's fees, which may be incurred, as a result of death or injuries to any person, or damage to any property, contamination of or adverse effects on the environment, caused in whole or in part by the Customer, its employees, or subcontractors in disposing waste at this Facility. In the event Customer delivers Unacceptable Waste (as determined by Republic) Customer agrees to assume all expenses and obligations with the removal and/or resolution of any effects caused by the delivery of such Unacceptable Waste.

Indemnización. Cliente acuerda indemnizar, mantener inmune, y defender Republic Services, Inc., sus subsidiarios, compañías, divisiones, empleados, oficiales y directores contra de cualquiera y de todas responsabilidades, demandas, penas, pérdidas, juicios, pleitos y los costos incidente además, incluyendo costos de defensa, de acuerdo judicial, y de honorarios razonables del abogado, que pueden ser incurridos en, o como resultado de, la muerte o herida personal a cualquier persona, o daños a cualquier característica, propiedad, contaminación de la tierra o efectos ilícitos en esta Facilidad, causado entero o en parte por el cliente, sus empleados, o sus subcontratistas en botar basura en esta Facilidad. En el caso que el Cliente entrega, bota, basura (según lo determinado por Republic) en este Establecimiento basura inaceptable en los reglamentos de este Establecimiento, el Cliente se compromete asumir todos los costos y obligaciones con el retiro y/o la resolución de cualquier dano(s) causado por la entrega de tal basura inaceptable.



NON-HAZARDOUS WASTE MANIFEST

MANIFEST # 12225

GENERATOR INFORMATION

Generator Name: Tronox LLC
Address: P.O. Box 55
City: Henderson County: Clark
State: NV Zip: 89009
Site Location (if different): 560 W. Lake Mead
Henderson, NV 89015 (702) 592-7727

CUSTOMER/BILLING INFORMATION

Billing Name: NGE LLC c/o Northgate Environment Management
Address: 300 Frank Ogawa Plaza, Ste 510
City: Oakland County: Alameda
State: CA Zip: 94612

Table with 5 columns: Republic Services Approval #, Description of Waste, Volume/Weight, Expiration Date, Container Type. Row 1: 38251011244, Soil for disposal, 31.78, 12-31-2011, Tractor with Dump Trailer(s).

*Attach Additional Sheet if necessary

I hereby certify that the above-described materials are non-hazardous wastes as defined by 40 CFR 261 or any applicable state law. Further, that the above named materials are properly classified, described, packaged, marked and labeled, and are in proper condition for transportation according to the applicable regulations of the Department of Transportation.

Susan Crowley (Signature)
Generator/Authorized Agent Name Signature Date Shipped

TRANSPORTER INFORMATION

Transporter Name: Las Vegas Paving DOT # 191949
Address: 4420 S. Decatur Truck Number: 125
Las Vegas, NV 89103 Phone Number: (702) 353-4355

I certify no hazardous waste or other regulated substance was knowingly introduced to the waste while in my custody. The waste transported in this vehicle is the waste identified above, to the best of my knowledge.

J Bowyer (Signature)
Name of Authorized Agent Signature Date Delivered 10-8-10

DISPOSAL SITE INFORMATION

Site Name: Apex Regional Landfill Phone No. (702) 599-5920
Address: 13550 U.S. Hwy 93 Las Vegas, NV

I hereby acknowledge receipt of the above described materials
Juan Moreno (Signature)
Name (Print or Type) Signature Date Received 10-8-10

81 Environmental Tech
13550 N Highway 93
Las Vegas, NV 89165

Ticket Type: INBOUND INVOICE

Ticket Number: 2143
Date: 10/08/2010
Time In: 12:50 pm
Time Out: 1:14 pm

Customer: 001011 - NGE, LLC c/o Northgate Environ Mgmt

Vehicle/Container: 73072P
Contract: Northgate Env. On Site Soils 3825 11
Comment: 3825 10 244

Gross Weight: 124,140 LB Manual In
Tare Weight: 50,200 LB Manual Out
Net Weight: 73940 LB
Net Tons: 36.97

BOL: 12226

Origin	Yards	Material	Billing	Quantity
Not Applicable	0.00 YD	SW CONTAMINATED SOIL	36.97	TN

Driver:



Weighmaster:

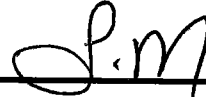

IN - JORDADE OUT - MORENOJ

Indemnification. Customer agrees, by signature above, to indemnify, hold harmless, and defend Republic Services, Inc., its subsidiaries, affiliates, employees, officers and directors from and against any and all liabilities, claims, penalties, forfeitures, suits and the costs and expenses incident thereto, including costs of defense, settlement, and reasonable attorney's fees, which may be incurred, as a result of death or injuries to any person, or damage to any property, contamination of or adverse effects on the environment, caused in whole or in part by the Customer, its employees, or subcontractors in disposing waste at this Facility. In the event Customer delivers Unacceptable Waste (as determined by Republic) Customer agrees to assume all expenses and obligations with the removal and/or resolution of any effects caused by the delivery of such Unacceptable Waste.

Indemnización. Cliente acuerda indemnizar, mantener inmune, y defender Republic Services, Inc., sus subsidiarios, compañías, divisiones, empleados, oficiales y directores contra de cualquiera y de todas responsabilidades, demandas, penas, pérdidas, juicios, pleitos y los costos incidente además, incluyendo costos de defensa, de acuerdo judicial, y de honorarios razonables del abogado, que pueden ser incurridos en, o como resultado de, la muerte o herida personal a cualquier persona, o daños a cualquier característica, propiedad, contaminación de la tierra o efectos ilícitos en esta Facilidad, causado entero o en parte por el cliente, sus empleados, o sus subcontratistas en botar basura en esta Facilidad. En el caso que el Cliente entrega, bota, basura (según lo determinado por Republic) en este Establecimiento basura inaceptable en los reglamentos de este Establecimiento, el Cliente se compromete asumir todos los costos y obligaciones con el retiro y/o la resolución de cualquier dano(s) causado por la entrega de tal basura inaceptable.



NON-HAZARDOUS WASTE MANIFEST

MANIFEST # 12226

GENERATOR INFORMATION

Generator Name: Tronox LLC
Address: P.O. Box 55
City: Henderson County: Clark
State: NV Zip: 89009
Site Location (if different): 560 W. Lake Mead
Henderson, NV 89015 (702) 592-7727

CUSTOMER/BILLING INFORMATION

Billing Name: NGE LLC c/o Northgate Environment Management
Address: 300 Frank Ogawa Plaza, Ste 510
City: Oakland County: Alameda
State: CA Zip: 94612

Table with 5 columns: Republic Services Approval #, Description of Waste, Volume/Weight, Expiration Date, Container Type. Row 1: 38251011244, Soil for disposal, 36.97, 12-31-2011, Tractor with Dump Trailer(s).

*Attach Additional Sheet if necessary

I hereby certify that the above-described materials are non-hazardous wastes as defined by 40 CFR 261 or any applicable state law. Further, that the above named materials are properly classified, described, packaged, marked and labeled, and are in proper condition for transportation according to the applicable regulations of the Department of Transportation.

Susan Crowley (Signature) 10-8-10 (Date Shipped)
Generator/Authorized Agent Name Signature Date Shipped

TRANSPORTER INFORMATION

Transporter Name: Las Vegas Paving DOT # 191949
Address: 4420 S. Decatur Truck Number: 135
Las Vegas, NV 89103 Phone Number: (702) 353-4355

I certify no hazardous waste or other regulated substance was knowingly introduced to the waste while in my custody. The waste transported in this vehicle is the waste identified above, to the best of my knowledge.

Robert Lee (Signature) 10-8-10 (Date Delivered)
Name of Authorized Agent Signature Date Delivered

DISPOSAL SITE INFORMATION

Site Name: Apex Regional Landfill Phone No. (702) 599-5920
Address: 13550 U.S. Hwy 93 Las Vegas, NV

I hereby acknowledge receipt of the above described materials
Blanche Jordan (Signature) 10-8-10 (Date Received)
Name (Print or Type) Signature Date Received

81 Environmental Tech
13550 N Highway 93
Las Vegas, NV 89165

Ticket Type: INBOUND INVOICE

Ticket Number: 2144
Date: 10/08/2010
Time In: 12:57 pm
Time Out: 1:22 pm

Customer: 001011 - NGE, LLC c/o Northgate Environ Mgmt

Vehicle/Container: 81496P
Contract: Northgate Env. On Site Soils 3825 11
Comment: 3825 10 11244

Gross Weight: 121,440 LB Manual In
Tare Weight: 50,660 LB Manual Out
Net Weight: 70780 LB
Net Tons: 35.39

BOL: 12227

Origin	Yards	Material	Billing	Quantity
Not Applicable	0.00 YD	SW CONTAMINATED SOIL	35.39	TN

Driver: _____



Weighmaster: _____

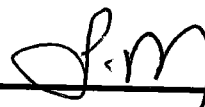

IN - JORDADE OUT - MORENOJ

Indemnification. Customer agrees, by signature above, to indemnify, hold harmless, and defend Republic Services, Inc., its subsidiaries, affiliates, employees, officers and directors from and against any and all liabilities, claims, penalties, forfeitures, suits and the costs and expenses incident thereto, including costs of defense, settlement, and reasonable attorney's fees, which may be incurred, as a result of death or injuries to any person, or damage to any property, contamination of or adverse effects on the environment, caused in whole or in part by the Customer, its employees, or subcontractors in disposing waste at this Facility. In the event Customer delivers Unacceptable Waste (as determined by Republic) Customer agrees to assume all expenses and obligations with the removal and/or resolution of any effects caused by the delivery of such Unacceptable Waste.

Indemnización. Cliente acuerda indemnizar, mantener inmune, y defender Republic Services, Inc., sus subsidiarios, compañías, divisiones, empleados, oficiales y directores contra de cualquiera y de todas responsabilidades, demandas, penas, pérdidas, juicios, pleitos y los costos incidente además, incluyendo costos de defensa, de acuerdo judicial, y de honorarios razonables del abogado, que pueden ser incurridos en, o como resultado de, la muerte o herida personal a cualquier persona, o daños a cualquier característica, propiedad, contaminación de la tierra o efectos ilícitos en esta Facilidad, causado entero o en parte por el cliente, sus empleados, o sus subcontratistas en botar basura en esta Facilidad. En el caso que el Cliente entrega, bota, basura (según lo determinado por Republic) en este Establecimiento basura inaceptable en los reglamentos de este Establecimiento, el Cliente se compromete asumir todos los costos y obligaciones con el retiro y/o la resolución de cualquier dano(s) causado por la entrega de tal basura inaceptable.



NON-HAZARDOUS WASTE MANIFEST

MANIFEST # 12227

GENERATOR INFORMATION

Generator Name: Tronox LLC

Address: P.O. Box 55

City: Henderson County: Clark

State: NV Zip: 89009

Site Location (if different): 560 W. Lake Mead
Henderson, NV 89015 (702) 592-7727

CUSTOMER/BILLING INFORMATION

Billing Name: NGE LLC c/o Northgate Environment Management

Address: 300 Frank Ogawa Plaza, Ste 510

City: Oakland County: Alameda

State: CA Zip: 94612

Table with 5 columns: Republic Services Approval #, Description of Waste, Volume/Weight, Expiration Date, Container Type. Row 1: 38251011244, Soil for disposal, 35.39 TN, 12-31-2011, Tractor with Dump Trailer(s).

*Attach Additional Sheet if necessary

I hereby certify that the above-described materials are non-hazardous wastes as defined by 40 CFR 261 or any applicable state law. Further, that the above named materials are properly classified, described, packaged, marked and labeled, and are in proper condition for transportation according to the applicable regulations of the Department of Transportation.

Susan Crowley
Generator/Authorized Agent Name Signature Date Shipped

TRANSPORTER INFORMATION

Transporter Name: Las Vegas Paving

DOT # 191949

Address: 4420 S. Decatur

Truck Number: 145

Las Vegas, NV 89103

Phone Number: (702) 353-4355

I certify no hazardous waste or other regulated substance was knowingly introduced to the waste while in my custody. The waste transported in this vehicle is the waste identified above, to the best of my knowledge.

Name of Authorized Agent Signature Date Delivered 10-8-10

DISPOSAL SITE INFORMATION

Site Name: Apex Regional Landfill

Phone No. (702) 599-5920

Address: 13550 U.S. Hwy 93 Las Vegas, NV

I hereby acknowledge receipt of the above described materials
Juan Moreno Signature Date Received 10-8-10

81 Environmental Tech
13550 N Highway 93
Las Vegas, NV 89165

Ticket Type: INBOUND INVOICE

Ticket Number: 2145
Date: 10/08/2010
Time In: 1:01 pm
Time Out: 1:25 pm

Customer: 001011 - NGE, LLC c/o Northgate Environ Mgmt

Vehicle/Container: 60573P
Contract: Northgate Env. On Site Soils 3825 11
Comment: 3825 10 11244

Gross Weight: 150,680 LB Manual In
Tare Weight: 57,940 LB Manual Out
Net Weight: 92740 LB
Net Tons: 46.37

BOL: 122228

Origin	Yards	Material	Billing	Quantity
Not Applicable	0.00 YD	SW CONTAMINATED SOIL	46.37	TN

Driver: _____



Weighmaster: _____

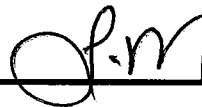

IN - JORDADE OUT - MORENOJ

Indemnification. Customer agrees, by signature above, to indemnify, hold harmless, and defend Republic Services, Inc., its subsidiaries, affiliates, employees, officers and directors from and against any and all liabilities, claims, penalties, forfeitures, suits and the costs and expenses incident thereto, including costs of defense, settlement, and reasonable attorney's fees, which may be incurred, as a result of death or injuries to any person, or damage to any property, contamination of or adverse effects on the environment, caused in whole or in part by the Customer, its employees, or subcontractors in disposing waste at this Facility. In the event Customer delivers Unacceptable Waste (as determined by Republic) Customer agrees to assume all expenses and obligations with the removal and/or resolution of any effects caused by the delivery of such Unacceptable Waste.

Indemnización. Cliente acuerda indemnizar, mantener inmune, y defender Republic Services, Inc., sus subsidiarios, compañías, divisiones, empleados, oficiales y directores contra de cualquiera y de todas responsabilidades, demandas, penas, pérdidas, juicios, pleitos y los costos incidente además, incluyendo costos de defensa, de acuerdo judicial, y de honorarios razonables del abogado, que pueden ser incurridos en, o como resultado de, la muerte o herida personal a cualquier persona, o daños a cualquier característica, propiedad, contaminación de la tierra o efectos ilícitos en esta Facilidad, causado entero o en parte por el cliente, sus empleados, o sus subcontratistas en botar basura en esta Facilidad. En el caso que el Cliente entrega, bota, basura (según lo determinado por Republic) en este Establecimiento basura inaceptable en los reglamentos de este Establecimiento, el Cliente se compromete asumir todos los costos y obligaciones con el retiro y/o la resolución de cualquier dano(s) causado por la entrega de tal basura inaceptable.



NON-HAZARDOUS WASTE MANIFEST

MANIFEST # 12228

GENERATOR INFORMATION

Generator Name: Tronox LLC
Address: P.O. Box 55
City: Henderson County: Clark
State: NV Zip: 89009
Site Location (if different): 560 W. Lake Mead
Henderson, NV 89015 (702) 592-7727

CUSTOMER/BILLING INFORMATION

Billing Name: NGE LLC c/o Northgate Environment Management
Address: 300 Frank Ogawa Plaza, Ste 510
City: Oakland County: Alameda
State: CA Zip: 94612

Table with 5 columns: Republic Services Approval #, Description of Waste, Volume/Weight, Expiration Date, Container Type. Row 1: 38251011244, Soil for disposal, 46.37, 12-31-2011, Tractor with Dump Trailer(s)

*Attach Additional Sheet if necessary

I hereby certify that the above-described materials are non-hazardous wastes as defined by 40 CFR 261 or any applicable state law. Further, that the above named materials are properly classified, described, packaged, marked and labeled, and are in proper condition for transportation according to the applicable regulations of the Department of Transportation.

Susan Crowley (Signature)
Generator/Authorized Agent Name Signature Date Shipped

TRANSPORTER INFORMATION

Transporter Name: Las Vegas Paving DOT # 191949
Address: 4420 S. Decatur Truck Number: 142
Las Vegas, NV 89103 Phone Number: (702) 353-4355

I certify no hazardous waste or other regulated substance was knowingly introduced to the waste while in my custody. The waste transported in this vehicle is the waste identified above, to the best of my knowledge.

(Signature)
Name of Authorized Agent Signature Date Delivered 10-8-10

DISPOSAL SITE INFORMATION

Site Name: Apex Regional Landfill Phone No. (702) 599-5920
Address: 13550 U.S. Hwy 93 Las Vegas, NV

I hereby acknowledge receipt of the above described materials
Juan Moreno (Signature)
Name (Print or Type) Signature Date Received 10-8-10

81 Environmental Tech
13550 N Highway 93
Las Vegas, NV 89165

Ticket Type: INBOUND INVOICE

Ticket Number: 2146
Date: 10/08/2010
Time In: 1:07 pm
Time Out: 1:27 pm

Customer: 001011 - NGE, LLC c/o Northgate Environ Mgmt

Vehicle/Container: 44264A
Contract: Northgate Env. On Site Soils 3825 11
Comment: 3825 10 11244

Gross Weight: 135,860 LB Manual In
Tare Weight: 56,280 LB Manual Out
Net Weight: 79580 LB
Net Tons: 39.79

BOL: 122229

Origin	Yards	Material	Billing Quantity
Not Applicable	0.00 YD	SW CONTAMINATED SOIL	39.79 TN

Driver: _____



Weighmaster: _____

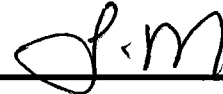

IN - JORDADE OUT - MORENOJ

Indemnification. Customer agrees, by signature above, to indemnify, hold harmless, and defend Republic Services, Inc., its subsidiaries, affiliates, employees, officers and directors from and against any and all liabilities, claims, penalties, forfeitures, suits and the costs and expenses incident thereto, including costs of defense, settlement, and reasonable attorney's fees, which may be incurred, as a result of death or injuries to any person, or damage to any property, contamination of or adverse effects on the environment, caused in whole or in part by the Customer, its employees, or subcontractors in disposing waste at this Facility. In the event Customer delivers Unacceptable Waste (as determined by Republic) Customer agrees to assume all expenses and obligations with the removal and/or resolution of any effects caused by the delivery of such Unacceptable Waste.

Indemnización. Cliente acuerda indemnizar, mantener inmune, y defender Republic Services, Inc., sus subsidiarios, companias, divisiones, empleados, oficiales y directores contra de cualquiera y de todas responsabilidades, demandas, penas, pérdidas, juicios, pleitos y los costos incidente además, incluyendo costos de defensa, de acuerdo judicial, y de honorarios razonables del abogado, que pueden ser incurridos en, o como resultado de, la muerte o herida personal a cualquier persona, o daños a cualquier característica, propiedad, contaminación de la tierra o efectos ilicitos en esta Facilidad, causado entero o en parte por el cliente, sus empleados, o sus subcontratistas en botar basura en esta Facilidad. En el caso que el Cliente entrega, bota, basura (según lo determinado por Republic) en este Establecimiento basura inaceptable en los reglamentos de este Establecimiento, el Cliente se compromete asumir todos los costos y obligaciones con el retiro y/o la resolución de cualquier dano(s) causado por la entrega de tal basura inaceptable.



NON-HAZARDOUS WASTE MANIFEST

MANIFEST # 12229

GENERATOR INFORMATION

Generator Name: Tronox LLC
Address: P.O. Box 55
City: Henderson County: Clark
State: NV Zip: 89009
Site Location (if different): 560 W. Lake Mead
Henderson, NV 89015 (702) 592-7727

CUSTOMER/BILLING INFORMATION

Billing Name: NGE LLC c/o Northgate Environment Management
Address: 300 Frank Ogawa Plaza, Ste 510
City: Oakland County: Alameda
State: CA Zip: 94612

Table with 5 columns: Republic Services Approval #, Description of Waste, Volume/Weight, Expiration Date, Container Type. Row 1: 38251011244, Soil for disposal, 39-79, 12-31-2011, Tractor with Dump Trailer(s).

*Attach Additional Sheet if necessary

I hereby certify that the above-described materials are non-hazardous wastes as defined by 40 CFR 261 or any applicable state law. Further, that the above named materials are properly classified, described, packaged, marked and labeled, and are in proper condition for transportation according to the applicable regulations of the Department of Transportation.

Susan Crowley
Generator/Authorized Agent Name
Signature: [Handwritten Signature]
Date Shipped

TRANSPORTER INFORMATION

Transporter Name: Las Vegas Paving DOT # 191949
Address: 4420 S. Decatur Truck Number: 100
Las Vegas, NV 89103 Phone Number: (702) 353-4355

I certify no hazardous waste or other regulated substance was knowingly introduced to the waste while in my custody. The waste transported in this vehicle is the waste identified above, to the best of my knowledge.

Name of Authorized Agent: [Handwritten Signature]
Signature: [Handwritten Signature]
Date Delivered: 10-8-10

DISPOSAL SITE INFORMATION

Site Name: Apex Regional Landfill Phone No. (702) 599-5920
Address: 13550 U.S. Hwy 93 Las Vegas, NV

I hereby acknowledge receipt of the above described materials
Name (Print or Type): Juan Moreno Signature: [Handwritten Signature] Date Received: 10-8-10

81 Environmental Tech
13550 N Highway 93
Las Vegas, NV 89165

Ticket Type: INBOUND INVOICE

Ticket Number: 2147
Date: 10/08/2010
Time In: 1:09 pm
Time Out: 1:31 pm

Customer: 001011 - NGE, LLC c/o Northgate Environ Mgmt

Vehicle/Container: 58507P
Contract: Northgate Env. On Site Soils 3825 11
Comment: 3825 10 11244

Gross Weight: 125,680 LB Manual In
Tare Weight: 54,020 LB Manual Out
Net Weight: 71660 LB
Net Tons: 35.83

BOL: 12230

Origin	Yards	Material	Billing	Quantity
Not Applicable	0.00 YD	SW CONTAMINATED SOIL	35.83	TN

Driver: _____



Weighmaster: _____



IN - JORDADE OUT - MORENOJ

Indemnification. Customer agrees, by signature above, to indemnify, hold harmless, and defend Republic Services, Inc., its subsidiaries, affiliates, employees, officers and directors from and against any and all liabilities, claims, penalties, forfeitures, suits and the costs and expenses incident thereto, including costs of defense, settlement, and reasonable attorney's fees, which may be incurred, as a result of death or injuries to any person, or damage to any property, contamination of or adverse effects on the environment, caused in whole or in part by the Customer, its employees, or subcontractors in disposing waste at this Facility. In the event Customer delivers Unacceptable Waste (as determined by Republic) Customer agrees to assume all expenses and obligations with the removal and/or resolution of any effects caused by the delivery of such Unacceptable Waste.

Indemnización. Cliente acuerda indemnizar, mantener inmune, y defender Republic Services, Inc., sus subsidiarios, compañías, divisiones, empleados, oficiales y directores contra de cualquiera y de todas responsabilidades, demandas, penas, pérdidas, juicios, pleitos y los costos incidente además, incluyendo costos de defensa, de acuerdo judicial, y de honorarios razonables del abogado, que pueden ser incurridos en, o como resultado de, la muerte o herida personal a cualquier persona, o daños a cualquier característica, propiedad, contaminación de la tierra o efectos ilícitos en esta Facilidad, causado entero o en parte por el cliente, sus empleados, o sus subcontratistas en botar basura en esta Facilidad. En el caso que el Cliente entrega, bota, basura (según lo determinado por Republic) en este Establecimiento basura inaceptable en los reglamentos de este Establecimiento, el Cliente se compromete asumir todos los costos y obligaciones con el retiro y/o la resolución de cualquier dano(s) causado por la entrega de tal basura inaceptable.



NON-HAZARDOUS WASTE MANIFEST

MANIFEST # 12230

GENERATOR INFORMATION

Generator Name: Tronox LLC

Address: P.O. Box 55

City: Henderson County: Clark

State: NV Zip: 89009

Site Location (if different): 560 W. Lake Mead
Henderson, NV 89015 (702) 592-7727

CUSTOMER/BILLING INFORMATION

Billing Name: NGE LLC c/o Northgate Environment Management

Address: 300 Frank Ogawa Plaza, Ste 510

City: Oakland County: Alameda

State: CA Zip: 94612

Republic Services Approval #	Description of Waste	Volume/Weight	Expiration Date	Container Type
38251011244	Soil for disposal		12-31-2011	Tractor with Dump Trailer(s)
	RZ- _____ # _____	<u>35.83</u>		

*Attach Additional Sheet if necessary

I hereby certify that the above-described materials are non-hazardous wastes as defined by 40 CFR 261 or any applicable state law. Further, that the above named materials are properly classified, described, packaged, marked and labeled, and are in proper condition for transportation according to the applicable regulations of the Department of Transportation.

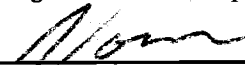
Susan Crowley  Tom Crowley
 Generator/Authorized Agent Name Signature Date Shipped

TRANSPORTER INFORMATION

Transporter Name: Las Vegas Paving

DOT # 191949

Address: 4420 S. Decatur

Truck Number: 1020

Las Vegas, NV 89103

Phone Number: (702) 353-4355

I certify no hazardous waste or other regulated substance was knowingly introduced to the waste while in my custody. The waste transported in this vehicle is the waste identified above, to the best of my knowledge.

 10-8-10
 Name of Authorized Agent Signature Date Delivered

DISPOSAL SITE INFORMATION

Site Name: Apex Regional Landfill

Phone No. (702) 599-5920

Address: 13550 U.S. Hwy 93 Las Vegas, NV

I hereby acknowledge receipt of the above described materials
Juan Moreno Juan Moreno 10-8-10
 Name (Print or Type) Signature Date Received

81 Environmental Tech
13550 N Highway 93
Las Vegas, NV 89165

Ticket Type: INBOUND INVOICE

Ticket Number: 2148
Date: 10/08/2010
Time In: 1:17 pm
Time Out: 1:44 pm

Customer: 001011 - NGE, LLC c/o Northgate Environ Mgmt

Vehicle/Container: 86680P
Contract: Northgate Env. On Site Soils 3825 11
Comment: 3825-10-11244

Gross Weight: 136,460 LB Manual In
Tare Weight: 54,480 LB Scale Out
Net Weight: 81980 LB
Net Tons: 40.99

BOL: 12231

Origin	Yards	Material	Billing	Quantity
Not Applicable	0.00 YD	SW CONTAMINATED SOIL	40.99 TN	

Driver: _____

Weighmaster: _____

IN - JORDADE OUT - GUILFDE

Indemnification. Customer agrees, by signature above, to indemnify, hold harmless, and defend Republic Services, Inc., its subsidiaries, affiliates, employees, officers and directors from and against any and all liabilities, claims, penalties, forfeitures, suits and the costs and expenses incident thereto, including costs of defense, settlement, and reasonable attorney's fees, which may be incurred, as a result of death or injuries to any person, or damage to any property, contamination of or adverse effects on the environment, caused in whole or in part by the Customer, its employees, or subcontractors in disposing waste at this Facility. In the event Customer delivers Unacceptable Waste (as determined by Republic) Customer agrees to assume all expenses and obligations with the removal and/or resolution of any effects caused by the delivery of such Unacceptable Waste.

Indemnización. Cliente acuerda indemnizar, mantener inmune, y defender Republic Services, Inc., sus subsidiarios, compañías, divisiones, empleados, oficiales y directores contra de cualquiera y de todas responsabilidades, demandas, penas, pérdidas, juicios, pleitos y los costos incidente además, incluyendo costos de defensa, de acuerdo judicial, y de honorarios razonables del abogado, que pueden ser incurridos en, o como resultado de, la muerte o herida personal a cualquier persona, o daños a cualquier característica, propiedad, contaminación de la tierra o efectos ilícitos en esta Facilidad, causado entero o en parte por el cliente, sus empleados, o sus subcontratistas en botar basura en esta Facilidad. En el caso que el Cliente entrega, bota, basura (según lo determinado por Republic) en este Establecimiento basura inaceptable en los reglamentos de este Establecimiento, el Cliente se compromete asumir todos los costos y obligaciones con el retiro y/o la resolución de cualquier dano(s) causado por la entrega de tal basura inaceptable.



NON-HAZARDOUS WASTE MANIFEST

MANIFEST # 12231

GENERATOR INFORMATION

Generator Name: Tronox LLC
Address: P.O. Box 55
City: Henderson County: Clark
State: NV Zip: 89009
Site Location (if different): 560 W. Lake Mead
Henderson, NV 89015 (702) 592-7727

CUSTOMER/BILLING INFORMATION

Billing Name: NGE LLC c/o Northgate Environment Management
Address: 300 Frank Ogawa Plaza, Ste 510
City: Oakland County: Alameda
State: CA Zip: 94612

Table with 5 columns: Republic Services Approval #, Description of Waste, Volume/Weight, Expiration Date, Container Type. Row 1: 38251011244, Soil for disposal, 40.99, 12-31-2011, Tractor with Dump Trailer(s).

*Attach Additional Sheet if necessary

I hereby certify that the above-described materials are non-hazardous wastes as defined by 40 CFR 261 or any applicable state law. Further, that the above named materials are properly classified, described, packaged, marked and labeled, and are in proper condition for transportation according to the applicable regulations of the Department of Transportation.

Susan Crowley
Generator/Authorized Agent Name Signature Date Shipped

TRANSPORTER INFORMATION

Transporter Name: Las Vegas Paving DOT # 191949
Address: 4420 S. Decatur Truck Number: ST 58
Las Vegas, NV 89103 Phone Number: (702) 353-4355

I certify no hazardous waste or other regulated substance was knowingly introduced to the waste while in my custody. The waste transported in this vehicle is the waste identified above, to the best of my knowledge.

Name of Authorized Agent Signature Date Delivered 10-8-10

DISPOSAL SITE INFORMATION

Site Name: Apex Regional Landfill Phone No. (702) 599-5920
Address: 13550 U.S. Hwy 93 Las Vegas, NV

I hereby acknowledge receipt of the above described materials
Name (Print or Type) Signature Date Received 10-8-10

81 Environmental Tech
13550 N Highway 93
Las Vegas, NV 89165

Ticket Type: INBOUND INVOICE

Ticket Number: 2149
Date: 10/08/2010
Time In: 1:27 pm
Time Out: 1:52 pm

Customer: 001011 - NGE, LLC c/o Northgate Environ Mgmt

Vehicle/Container: 86680P
Contract: Northgate Env. On Site Soils 3825 11
Comment: 3825.10-11244

Gross Weight: 124,400 LB Manual In
Tare Weight: 49,560 LB Manual Out
Net Weight: 74840 LB
Net Tons: 37.42

BOL: 12232

Origin	Yards	Material	Billing Quantity
Not Applicable	0.00 YD	SW CONTAMINATED SOIL	37.42 TN

Driver: _____



Weighmaster: _____



IN - JORDADE OUT - GUILFDE

Indemnification. Customer agrees, by signature above, to indemnify, hold harmless, and defend Republic Services, Inc., its subsidiaries, affiliates, employees, officers and directors from and against any and all liabilities, claims, penalties, forfeitures, suits and the costs and expenses incident thereto, including costs of defense, settlement, and reasonable attorney's fees, which may be incurred, as a result of death or injuries to any person, or damage to any property, contamination of or adverse effects on the environment, caused in whole or in part by the Customer, its employees, or subcontractors in disposing waste at this Facility. In the event Customer delivers Unacceptable Waste (as determined by Republic) Customer agrees to assume all expenses and obligations with the removal and/or resolution of any effects caused by the delivery of such Unacceptable Waste.

Indemnización. Cliente acuerda indemnizar, mantener inmune, y defender Republic Services, Inc., sus subsidiarios, compañías, divisiones, empleados, oficiales y directores contra de cualquiera y de todas responsabilidades, demandas, penas, pérdidas, juicios, pleitos y los costos incidente además, incluyendo costos de defensa, de acuerdo judicial, y de honorarios razonables del abogado, que pueden ser incurridos en, o como resultado de, la muerte o herida personal a cualquier persona, o daños a cualquier característica, propiedad, contaminación de la tierra o efectos ilícitos en esta Facilidad, causado entero o en parte por el cliente, sus empleados, o sus subcontratistas en botar basura en esta Facilidad. En el caso que el Cliente entrega, bota, basura (según lo determinado por Republic) en este Establecimiento basura inaceptable en los reglamentos de este Establecimiento, el Cliente se compromete asumir todos los costos y obligaciones con el retiro y/o la resolución de cualquier dano(s) causado por la entrega de tal basura inaceptable.



NON-HAZARDOUS WASTE MANIFEST

MANIFEST # 12232

GENERATOR INFORMATION

Generator Name: Tronox LLC
Address: P.O. Box 55
City: Henderson County: Clark
State: NV Zip: 89009
Site Location (if different): 560 W. Lake Mead
Henderson, NV 89015 (702) 592-7727

CUSTOMER/BILLING INFORMATION

Billing Name: NGE LLC c/o Northgate Environment Management
Address: 300 Frank Ogawa Plaza, Ste 510
City: Oakland County: Alameda
State: CA Zip: 94612

Table with 5 columns: Republic Services Approval #, Description of Waste, Volume/Weight, Expiration Date, Container Type. Row 1: 38251011244, Soil for disposal, 3742, 12-31-2011, Tractor with Dump Trailer(s). Row 2: RZ- #

*Attach Additional Sheet if necessary

I hereby certify that the above-described materials are non-hazardous wastes as defined by 40 CFR 261 or any applicable state law. Further, that the above named materials are properly classified, described, packaged, marked and labeled, and are in proper condition for transportation according to the applicable regulations of the Department of Transportation.

Susan Crowley
Generator/Authorized Agent Name Signature Date Shipped

TRANSPORTER INFORMATION

Transporter Name: Las Vegas Paving DOT # 191949
Address: 4420 S. Decatur Truck Number: 110
Las Vegas, NV 89103 Phone Number: (702) 353-4355

I certify no hazardous waste or other regulated substance was knowingly introduced to the waste while in my custody. The waste transported in this vehicle is the waste identified above, to the best of my knowledge.

Name of Authorized Agent Signature Date Delivered 10-8-10

DISPOSAL SITE INFORMATION

Site Name: Apex Regional Landfill Phone No. (702) 599-5920
Address: 13550 U.S. Hwy 93 Las Vegas, NV

I hereby acknowledge receipt of the above described materials
Debbie Gault Name (Print or Type) Signature Date Received 10-8-10

81 Environmental Tech
13550 N Highway 93
Las Vegas, NV 89165

Ticket Type: INBOUND INVOICE

Ticket Number: 2150
Date: 10/08/2010
Time In: 1:28 pm
Time Out: 1:55 pm

Customer: 001011 - NGE, LLC c/o Northgate Environ Mgmt

Vehicle/Container: 29573A
Contract: Northgate Env. On Site Soils 3825 1I
Comment: 3825-10-11244

Gross Weight: 127,260 LB Manual In
Tare Weight: 52,980 LB Manual Out
Net Weight: 74280 LB
Net Tons: 37.14

BOL: 12233

Origin	Yards	Material	Billing Quantity
Not Applicable	0.00 YD	SW CONTAMINATED SOIL	37.14 TN

Driver: 

Weighmaster: 

IN - JORDADE OUT - GUILFDE

Indemnification. Customer agrees, by signature above, to indemnify, hold harmless, and defend Republic Services, Inc., its subsidiaries, affiliates, employees, officers and directors from and against any and all liabilities, claims, penalties, forfeitures, suits and the costs and expenses incident thereto, including costs of defense, settlement, and reasonable attorney's fees, which may be incurred, as a result of death or injuries to any person, or damage to any property, contamination of or adverse effects on the environment, caused in whole or in part by the Customer, its employees, or subcontractors in disposing waste at this Facility. In the event Customer delivers Unacceptable Waste (as determined by Republic) Customer agrees to assume all expenses and obligations with the removal and/or resolution of any effects caused by the delivery of such Unacceptable Waste.

Indemnización. Cliente acuerda indemnizar, mantener inmune, y defender Republic Services, Inc., sus subsidiarios, compañías, divisiones, empleados, oficiales y directores contra de cualquiera y de todas responsabilidades, demandas, penas, pérdidas, juicios, pleitos y los costos incidente además, incluyendo costos de defensa, de acuerdo judicial, y de honorarios razonables del abogado, que pueden ser incurridos en, o como resultado de, la muerte o herida personal a cualquier persona, o daños a cualquier característica, propiedad, contaminación de la tierra o efectos ilícitos en esta Facilidad, causado entero o en parte por el cliente, sus empleados, o sus subcontratistas en botar basura en esta Facilidad. En el caso que el Cliente entrega, bota, basura (según lo determinado por Republic) en este Establecimiento basura inaceptable en los reglamentos de este Establecimiento, el Cliente se compromete asumir todos los costos y obligaciones con el retiro y/o la resolución de cualquier dano(s) causado por la entrega de tal basura inaceptable.



NON-HAZARDOUS WASTE MANIFEST

MANIFEST # 12233

GENERATOR INFORMATION

Generator Name: Tronox LLC
Address: P.O. Box 55
City: Henderson County: Clark
State: NV Zip: 89009
Site Location (if different): 560 W. Lake Mead
Henderson, NV 89015 (702) 592-7727

CUSTOMER/BILLING INFORMATION

Billing Name: NGE LLC c/o Northgate Environment Management
Address: 300 Frank Ogawa Plaza, Ste 510
City: Oakland County: Alameda
State: CA Zip: 94612

Table with 5 columns: Republic Services Approval #, Description of Waste, Volume/Weight, Expiration Date, Container Type. Row 1: 38251011244, Soil for disposal, 37.14, 12-31-2011, Tractor with Dump Trailer(s). Row 2: RZ- #

*Attach Additional Sheet if necessary

I hereby certify that the above-described materials are non-hazardous wastes as defined by 40 CFR 261 or any applicable state law. Further, that the above named materials are properly classified, described, packaged, marked and labeled, and are in proper condition for transportation according to the applicable regulations of the Department of Transportation.

Susan Crowley
Generator/Authorized Agent Name Signature Date Shipped

TRANSPORTER INFORMATION

Transporter Name: Las Vegas Paving DOT # 191949
Address: 4420 S. Decatur Truck Number: HR 17
Las Vegas, NV 89103 Phone Number: (702) 353-4355

I certify no hazardous waste or other regulated substance was knowingly introduced to the waste while in my custody. The waste transported in this vehicle is the waste identified above, to the best of my knowledge.

Name of Authorized Agent Signature Date Delivered 10-8-10

DISPOSAL SITE INFORMATION

Site Name: Apex Regional Landfill Phone No. (702) 599-5920
Address: 13550 U.S. Hwy 93 Las Vegas, NV

I hereby acknowledge receipt of the above described materials
Name (Print or Type) Signature Date Received 10-8-10



NON-HAZARDOUS WASTE MANIFEST

MANIFEST # 12236

GENERATOR INFORMATION

Generator Name: Tronox LLC

Address: P.O. Box 55

City: Henderson County: Clark

State: NV Zip: 89009

Site Location (if different): 560 W. Lake Mead

Henderson, NV 89015 (702) 592-7727

CUSTOMER/BILLING INFORMATION

Billing Name: NGE LLC c/o Northgate Environment Management

Address: 300 Frank Ogawa Plaza, Ste 510

City: Oakland County: Alameda

State: CA Zip: 94612

Republic Services Approval #	Description of Waste	Volume/Weight	Expiration Date	Container Type
38251011244	Soil for disposal		12-31-2011	Tractor with Dump Trailer(s)
	RZ- #	3459		

*Attach Additional Sheet if necessary

I hereby certify that the above-described materials are non-hazardous wastes as defined by 40 CFR 261 or any applicable state law. Further, that the above named materials are properly classified, described, packaged, marked and labeled, and are in proper condition for transportation according to the applicable regulations of the Department of Transportation.

Susan Crowley Generator/Authorized Agent Name Signature Date Shipped

TRANSPORTER INFORMATION

Transporter Name: Las Vegas Paving

DOT # 191949

Address: 4420 S. Decatur

Truck Number: RH301

Las Vegas, NV 89103

Phone Number: (702) 353-4355

I certify no hazardous waste or other regulated substance was knowingly introduced to the waste while in my custody. The waste transported in this vehicle is the waste identified above, to the best of my knowledge.

Name of Authorized Agent Signature Date Delivered 10-8-10

DISPOSAL SITE INFORMATION

Site Name: Apex Regional Landfill

Phone No. (702) 599-5920

Address: 13550 U.S. Hwy 93 Las Vegas, NV

I hereby acknowledge receipt of the above described materials Name (Print or Type) Signature Date Received 10-8-10

81 Environmental Tech
13550 N Highway 93
Las Vegas, NV 89165

Ticket Type: INBOUND INVOICE

Ticket Number: 2152
Date: 10/08/2010
Time In: 1:56 pm
Time Out: 2:21 pm

Customer: 001011 - NGE, LLC c/o Northgate Environ Mgmt

Vehicle/Container: Z009877
Contract: Northgate Env. On Site Soils 3825 11
Comment: 3825-10-11244

Gross Weight: 119,140 LB Manual In
Tare Weight: 48,660 LB Manual Out
Net Weight: 70480 LB
Net Tons: 35.24

BOL: 12237

Origin	Yards	Material	Billing Quantity
Not Applicable	0.00 YD	SW CONTAMINATED SOIL	35.24 TN

Driver: _____

Weighmaster: _____

IN - JORDADE OUT - GUILFDE

Indemnification. Customer agrees, by signature above, to indemnify, hold harmless, and defend Republic Services, Inc., its subsidiaries, affiliates, employees, officers and directors from and against any and all liabilities, claims, penalties, forfeitures, suits and the costs and expenses incident thereto, including costs of defense, settlement, and reasonable attorney's fees, which may be incurred, as a result of death or injuries to any person, or damage to any property, contamination of or adverse effects on the environment, caused in whole or in part by the Customer, its employees, or subcontractors in disposing waste at this Facility. In the event Customer delivers Unacceptable Waste (as determined by Republic) Customer agrees to assume all expenses and obligations with the removal and/or resolution of any effects caused by the delivery of such Unacceptable Waste.

Indemnización. Cliente acuerda indemnizar, mantener inmune, y defender Republic Services, Inc., sus subsidiarios, compañías, divisiones, empleados, oficiales y directores contra de cualquiera y de todas responsabilidades, demandas, penas, pérdidas, juicios, pleitos y los costos incidente además, incluyendo costos de defensa, de acuerdo judicial, y de honorarios razonables del abogado, que pueden ser incurridos en, o como resultado de, la muerte o herida personal a cualquier persona, o daños a cualquier característica, propiedad, contaminación de la tierra o efectos ilícitos en esta Facilidad, causado entero o en parte por el cliente, sus empleados, o sus subcontratistas en botar basura en esta Facilidad. En el caso que el Cliente entrega, bota, basura (según lo determinado por Republic) en este Establecimiento basura inaceptable en los reglamentos de este Establecimiento, el Cliente se compromete asumir todos los costos y obligaciones con el retiro y/o la resolución de cualquier dano(s) causado por la entrega de tal basura inaceptable.



NON-HAZARDOUS WASTE MANIFEST

MANIFEST # 12237

GENERATOR INFORMATION

Generator Name: Tronox LLC
Address: P.O. Box 55
City: Henderson County: Clark
State: NV Zip: 89009
Site Location (if different): 560 W. Lake Mead
Henderson, NV 89015 (702) 592-7727

CUSTOMER/BILLING INFORMATION

Billing Name: NGE LLC c/o Northgate Environment Management
Address: 300 Frank Ogawa Plaza, Ste 510
City: Oakland County: Alameda
State: CA Zip: 94612

Table with 5 columns: Republic Services Approval #, Description of Waste, Volume/Weight, Expiration Date, Container Type. Row 1: 38251011244, Soil for disposal, 35.24, 12-31-2011, Tractor with Dump Trailer(s).

*Attach Additional Sheet if necessary

I hereby certify that the above-described materials are non-hazardous wastes as defined by 40 CFR 261 or any applicable state law. Further, that the above named materials are properly classified, described, packaged, marked and labeled, and are in proper condition for transportation according to the applicable regulations of the Department of Transportation.

Susan Crowley
Generator/Authorized Agent Name Signature Date Shipped

TRANSPORTER INFORMATION

Transporter Name: Las Vegas Paving DOT # 191949
Address: 4420 S. Decatur Truck Number: 2010
Las Vegas, NV 89103 Phone Number: (702) 353-4355

I certify no hazardous waste or other regulated substance was knowingly introduced to the waste while in my custody. The waste transported in this vehicle is the waste identified above, to the best of my knowledge.

Name of Authorized Agent Signature Date Delivered 10.8.10

DISPOSAL SITE INFORMATION

Site Name: Apex Regional Landfill Phone No. (702) 599-5920
Address: 13550 U.S. Hwy 93 Las Vegas, NV

I hereby acknowledge receipt of the above described materials
Debbie Goutelle Signature Date Received 10-8-10

81 Environmental Tech
13550 N Highway 93
Las Vegas, NV 89165

Ticket Type: INBOUND INVOICE

Ticket Number: 2154
Date: 10/08/2010
Time In: 1:55 pm
Time Out: 2:24 pm

Customer: 001011 - NGE, LLC c/o Northgate Environ Mgmt

Vehicle/Container: 44164A
Contract: Northgate Env. On Site Soils 3825 11
Comment: 3825-10-11244

Gross Weight: 121,500 LB Manual In
Tare Weight: 55,880 LB Manual Out
Net Weight: 65620 LB
Net Tons: 32.81

BOL: 12235

Origin	Yards	Material	Billing Quantity
Not Applicable	0.00 YD	SW CONTAMINATED SOIL	32.81 TN

Driver: B My

Weighmaster: [Signature]

IN - JORDADE OUT - GUILFDE

Indemnification. Customer agrees, by signature above, to indemnify, hold harmless, and defend Republic Services, Inc., its subsidiaries, affiliates, employees, officers and directors from and against any and all liabilities, claims, penalties, forfeitures, suits and the costs and expenses incident thereto, including costs of defense, settlement, and reasonable attorney's fees, which may be incurred, as a result of death or injuries to any person, or damage to any property, contamination of or adverse effects on the environment, caused in whole or in part by the Customer, its employees, or subcontractors in disposing waste at this Facility. In the event Customer delivers Unacceptable Waste (as determined by Republic) Customer agrees to assume all expenses and obligations with the removal and/or resolution of any effects caused by the delivery of such Unacceptable Waste.

Indemnización. Cliente acuerda indemnizar, mantener inmune, y defender Republic Services, Inc., sus subsidiarios, compañías, divisiones, empleados, oficiales y directores contra de cualquiera y de todas responsabilidades, demandas, penas, pérdidas, juicios, pleitos y los costos incidente además, incluyendo costos de defensa, de acuerdo judicial, y de honorarios razonables del abogado, que pueden ser incurridos en, o como resultado de, la muerte o herida personal a cualquier persona, o daños a cualquier característica, propiedad, contaminación de la tierra o efectos ilícitos en esta Facility, causado entero o en parte por el cliente, sus empleados, o sus subcontratistas en botar basura en esta Facility. En el caso que el Cliente entrega, bota, basura (según lo determinado por Republic) en este Establecimiento basura inaceptable en los reglamentos de este Establecimiento, el Cliente se compromete asumir todos los costos y obligaciones con el retiro y/o la resolución de cualquier daño(s) causado por la entrega de tal basura inaceptable.



NON-HAZARDOUS WASTE MANIFEST

MANIFEST # 12235

GENERATOR INFORMATION

Generator Name: Tronox LLC

Address: P.O. Box 55

City: Henderson County: Clark

State: NV Zip: 89009

Site Location (if different): 560 W. Lake Mead

Henderson, NV 89015 (702) 592-7727

CUSTOMER/BILLING INFORMATION

Billing Name: NGE LLC c/o Northgate Environment Management

Address: 300 Frank Ogawa Plaza, Ste 510

City: Oakland County: Alameda

State: CA Zip: 94612

Republic Services Approval #	Description of Waste	Volume/Weight	Expiration Date	Container Type
38251011244	Soil for disposal		12-31-2011	Tractor with Dump Trailer(s)
	RZ- #	32.81		

*Attach Additional Sheet if necessary

I hereby certify that the above-described materials are non-hazardous wastes as defined by 40 CFR 261 or any applicable state law. Further, that the above named materials are properly classified, described, packaged, marked and labeled, and are in proper condition for transportation according to the applicable regulations of the Department of Transportation.

Susan Crowley Generator/Authorized Agent Name Signature Date Shipped

TRANSPORTER INFORMATION

Transporter Name: Las Vegas Paving

DOT # 191949

Address: 4420 S. Decatur

Truck Number: K-006

Las Vegas, NV 89103

Phone Number: (702) 353-4355

I certify no hazardous waste or other regulated substance was knowingly introduced to the waste while in my custody. The waste transported in this vehicle is the waste identified above, to the best of my knowledge.

Brian Mulvey Name of Authorized Agent Signature Date Delivered 10-8-10

DISPOSAL SITE INFORMATION

Site Name: Apex Regional Landfill

Phone No. (702) 599-5920

Address: 13550 U.S. Hwy 93 Las Vegas, NV

Debbie Goutate Name (Print or Type) Signature Date Received 10-8-10

M.C.T.

81 Environmental Tech
13550 N Highway 93
Las Vegas, NV 89165

Ticket Type: INBOUND INVOICE

Ticket Number: 2155
Date: 10/08/2010
Time In: 1:53 pm
Time Out: 2:41 pm

Customer: 001011 - NGE, LLC c/o Northgate Environ Mgmt

Vehicle/Container: 83951P
Contract: Northgate Env. On Site Soils 3825 11
Comment: 3825-10-11244

Gross Weight: ~~131,520~~ LB Manual In
Tare Weight: 53,120 LB Manual Out
Net Weight: 78,400 LB
Net Tons: 39.20

73720 / ~~131,520~~
\$7,800

BOL: 12240

Origin	Yards	Material	Billing	Quantity
Not Applicable	0.00 YD	SW CONTAMINATED SOIL	39.20	TN

36.86

Driver: _____

Weighmaster: _____

IN - JORDADE OUT - GUILFDE

Indemnification. Customer agrees, by signature above, to indemnify, hold harmless, and defend Republic Services, Inc., its subsidiaries, affiliates, employees, officers and directors from and against any and all liabilities, claims, penalties, forfeitures, suits and the costs and expenses incident thereto, including costs of defense, settlement, and reasonable attorney's fees, which may be incurred, as a result of death or injuries to any person, or damage to any property, contamination of or adverse effects on the environment, caused in whole or in part by the Customer, its employees, or subcontractors in disposing waste at this Facility. In the event Customer delivers Unacceptable Waste (as determined by Republic) Customer agrees to assume all expenses and obligations with the removal and/or resolution of any effects caused by the delivery of such Unacceptable Waste.

Indemnización. Cliente acuerda indemnizar, mantener inmune, y defender Republic Services, Inc., sus subsidiarios, compañías, divisiones, empleados, oficiales y directores contra de cualquiera y de todas responsabilidades, demandas, penas, pérdidas, juicios, pleitos y los costos incidente además, incluyendo costos de defensa, de acuerdo judicial, y de honorarios razonables del abogado, que pueden ser incurridos en, o como resultado de, la muerte o herida personal a cualquier persona, o daños a cualquier característica, propiedad, contaminación de la tierra o efectos ilícitos en esta Facilidad, causado entero o en parte por el cliente, sus empleados, o sus subcontratistas en botar basura en esta Facilidad. En el caso que el Cliente entrega, bota, basura (según lo determinado por Republic) en este Establecimiento basura inaceptable en los reglamentos de este Establecimiento, el Cliente se compromete asumir todos los costos y obligaciones con el retiro y/o la resolución de cualquier dano(s) causado por la entrega de tal basura inaceptable.



NON-HAZARDOUS WASTE MANIFEST

MANIFEST # 12240

GENERATOR INFORMATION

Generator Name: Tronox LLC
Address: P.O. Box 55
City: Henderson County: Clark
State: NV Zip: 89009
Site Location (if different): 560 W. Lake Mead
Henderson, NV 89015 (702) 592-7727

CUSTOMER/BILLING INFORMATION

Billing Name: NGE LLC c/o Northgate Environment Management
Address: 300 Frank Ogawa Plaza, Ste 510
City: Oakland County: Alameda
State: CA Zip: 94612

Table with 5 columns: Republic Services Approval #, Description of Waste, Volume/Weight, Expiration Date, Container Type. Row 1: 38251011244, Soil for disposal, 36.86 TN, 12-31-2011, Tractor with Dump Trailer(s). Row 2: RZ- #, [scribble]

*Attach Additional Sheet if necessary

I hereby certify that the above-described materials are non-hazardous wastes as defined by 40 CFR 261 or any applicable state law. Further, that the above named materials are properly classified, described, packaged, marked and labeled, and are in proper condition for transportation according to the applicable regulations of the Department of Transportation.

Susan Crowley
Generator/Authorized Agent Name Signature Date Shipped

TRANSPORTER INFORMATION

Transporter Name: Las Vegas Paving DOT # 191949
Address: 4420 S. Decatur Truck Number: 07
Las Vegas, NV 89103 Phone Number: (702) 353-4355

I certify no hazardous waste or other regulated substance was knowingly introduced to the waste while in my custody. The waste transported in this vehicle is the waste identified above, to the best of my knowledge.

Name of Authorized Agent Signature Date Delivered 10-8-10

DISPOSAL SITE INFORMATION

Site Name: Apex Regional Landfill Phone No. (702) 599-5920
Address: 13550 U.S. Hwy 93 Las Vegas, NV

I hereby acknowledge receipt of the above described materials
Debbie Cantore Signature Date Received 10-8-10

81 Environmental Tech
13550 N Highway 93
Las Vegas, NV 89165

Ticket Type: INBOUND INVOICE

Ticket Number: 2156
Date: 10/08/2010
Time In: 2:18 pm
Time Out: 2:44 pm

Customer: 001011 - NGE, LLC c/o Northgate Environ Mgmt

Vehicle/Container: 80812P
Contract: Northgate Env. On Site Soils 3825 10
Comment: 3825-10-11244

Gross Weight: 134,760 LB Manual In
Tare Weight: 56,280 LB Manual Out
Net Weight: 78480 LB
Net Tons: 39.24

BOL: 12238

Origin	Yards	Material	Billing	Quantity
Not Applicable	0.00 YD	SW CONTAMINATED SOIL	39.24	TN

Driver: _____

Weighmaster: _____

IN - JORDADE OUT - GUILFDE

Indemnification. Customer agrees, by signature above, to indemnify, hold harmless, and defend Republic Services, Inc., its subsidiaries, affiliates, employees, officers and directors from and against any and all liabilities, claims, penalties, forfeitures, suits and the costs and expenses incident thereto, including costs of defense, settlement, and reasonable attorney's fees, which may be incurred, as a result of death or injuries to any person, or damage to any property, contamination of or adverse effects on the environment, caused in whole or in part by the Customer, its employees, or subcontractors in disposing waste at this Facility. In the event Customer delivers Unacceptable Waste (as determined by Republic) Customer agrees to assume all expenses and obligations with the removal and/or resolution of any effects caused by the delivery of such Unacceptable Waste.

Indemnización. Cliente acuerda indemnizar, mantener inmune, y defender Republic Services, Inc., sus subsidiarios, compañías, divisiones, empleados, oficiales y directores contra de cualquiera y de todas responsabilidades, demandas, penas, pérdidas, juicios, pleitos y los costos incidente además, incluyendo costos de defensa, de acuerdo judicial, y de honorarios razonables del abogado, que pueden ser incurridos en, o como resultado de, la muerte o herida personal a cualquier persona, o daños a cualquier característica, propiedad, contaminación de la tierra o efectos ilícitos en esta Facilidad, causado entero o en parte por el cliente, sus empleados, o sus subcontratistas en botar basura en esta Facilidad. En el caso que el Cliente entrega, bota, basura (según lo determinado por Republic) en este Establecimiento basura inaceptable en los reglamentos de este Establecimiento, el Cliente se compromete asumir todos los costos y obligaciones con el retiro y/o la resolución de cualquier dano(s) causado por la entrega de tal basura inaceptable.



NON-HAZARDOUS WASTE MANIFEST

MANIFEST # 12238

GENERATOR INFORMATION

Generator Name: Tronox LLC

Address: P.O. Box 55

City: Henderson County: Clark

State: NV Zip: 89009

Site Location (if different): 560 W. Lake Mead

Henderson, NV 89015 (702) 592-7727

CUSTOMER/BILLING INFORMATION

Billing Name: NGE LLC c/o Northgate Environment Management

Address: 300 Frank Ogawa Plaza, Ste 510

City: Oakland County: Alameda

State: CA Zip: 94612

Republic Services Approval #	Description of Waste	Volume/Weight	Expiration Date	Container Type
38251011244	Soil for disposal		12-31-2011	Tractor with Dump Trailer(s)
	RZ- #	3924		

*Attach Additional Sheet if necessary

I hereby certify that the above-described materials are non-hazardous wastes as defined by 40 CFR 261 or any applicable state law. Further, that the above named materials are properly classified, described, packaged, marked and labeled, and are in proper condition for transportation according to the applicable regulations of the Department of Transportation.

Susan Crowley (Signature) Date Shipped

TRANSPORTER INFORMATION

Transporter Name: Las Vegas Paving

DOT # 191949

Address: 4420 S. Decatur

Truck Number: 03

Las Vegas, NV 89103

Phone Number: (702) 353-4355

I certify no hazardous waste or other regulated substance was knowingly introduced to the waste while in my custody. The waste transported in this vehicle is the waste identified above, to the best of my knowledge.

(Signature) Date Delivered 10-8-10

DISPOSAL SITE INFORMATION

Site Name: Apex Regional Landfill

Phone No. (702) 599-5920

Address: 13550 U.S. Hwy 93 Las Vegas, NV

I hereby acknowledge receipt of the above described materials (Signature) Date Received 10-8-10

81 Environmental Tech
13550 N Highway 93
Las Vegas, NV 89165

Ticket Type: INBOUND INVOICE

Ticket Number: 2157
Date: 10/08/2010
Time In: 2:22 pm
Time Out: 2:49 pm

Customer: 001011 - NGE, LLC c/o Northgate Environ Mgmt

Vehicle/Container: 85914P
Contract: Northgate Env. On Site Soils 3825 11
Comment: 3825-10-11244

Gross Weight: 118,720 LB Manual In
Tare Weight: 53,640 LB Manual Out
Net Weight: 65080 LB
Net Tons: 32.54

BOL: 12241

Origin	Yards	Material	Billing	Quantity
Not Applicable	0.00 YD	SW CONTAMINATED SOIL	32.54	TN

Driver: 

Weighmaster: 

IN - JORDADE OUT - GUILFDE

Indemnification. Customer agrees, by signature above, to indemnify, hold harmless, and defend Republic Services, Inc., its subsidiaries, affiliates, employees, officers and directors from and against any and all liabilities, claims, penalties, forfeitures, suits and the costs and expenses incident thereto, including costs of defense, settlement, and reasonable attorney's fees, which may be incurred, as a result of death or injuries to any person, or damage to any property, contamination of or adverse effects on the environment, caused in whole or in part by the Customer, its employees, or subcontractors in disposing waste at this Facility. In the event Customer delivers Unacceptable Waste (as determined by Republic) Customer agrees to assume all expenses and obligations with the removal and/or resolution of any effects caused by the delivery of such Unacceptable Waste.

Indemnización. Cliente acuerda indemnizar, mantener inmune, y defender Republic Services, Inc., sus subsidiarios, compañías, divisiones, empleados, oficiales y directores contra de cualquiera y de todas responsabilidades, demandas, penas, pérdidas, juicios, pleitos y los costos incidente además, incluyendo costos de defensa, de acuerdo judicial, y de honorarios razonables del abogado, que pueden ser incurridos en, o como resultado de, la muerte o herida personal a cualquier persona, o daños a cualquier característica, propiedad, contaminación de la tierra o efectos ilícitos en esta Facilidad, causado entero o en parte por el cliente, sus empleados, o sus subcontratistas en botar basura en esta Facilidad. En el caso que el Cliente entrega, bota, basura (según lo determinado por Republic) en este Establecimiento basura inaceptable en los reglamentos de este Establecimiento, el Cliente se compromete asumir todos los costos y obligaciones con el retiro y/o la resolución de cualquier dano(s) causado por la entrega de tal basura inaceptable.



NON-HAZARDOUS WASTE MANIFEST

MANIFEST # 12241

GENERATOR INFORMATION

Generator Name: Tronox LLC

Address: P.O. Box 55

City: Henderson County: Clark

State: NV Zip: 89009

Site Location (if different): 560 W. Lake Mead

Henderson, NV 89015 (702) 592-7727

CUSTOMER/BILLING INFORMATION

Billing Name: NGE LLC c/o Northgate Environment Management

Address: 300 Frank Ogawa Plaza, Ste 510

City: Oakland County: Alameda

State: CA Zip: 94612

Republic Services Approval #	Description of Waste	Volume/Weight	Expiration Date	Container Type
38251011244	Soil for disposal	32.54	12-31-2011	Tractor with Dump Trailer(s)
	RZ- #	35.54		

*Attach Additional Sheet if necessary

I hereby certify that the above-described materials are non-hazardous wastes as defined by 40 CFR 261 or any applicable state law. Further, that the above named materials are properly classified, described, packaged, marked and labeled, and are in proper condition for transportation according to the applicable regulations of the Department of Transportation.

Susan Crowley Generator/Authorized Agent Name Signature Date Shipped

TRANSPORTER INFORMATION

Transporter Name: Las Vegas Paving

DOT # 191949

Address: 4420 S. Decatur

Truck Number: DE 07

Las Vegas, NV 89103

Phone Number: (702) 353-4355

I certify no hazardous waste or other regulated substance was knowingly introduced to the waste while in my custody. The waste transported in this vehicle is the waste identified above, to the best of my knowledge.

DAVID DELCID Signature Date Delivered 10.8.10

DISPOSAL SITE INFORMATION

Site Name: Apex Regional Landfill

Phone No. (702) 599-5920

Address: 13550 U.S. Hwy 93 Las Vegas, NV

I hereby acknowledge receipt of the above described materials Debbie Gutfreund Signature Date Received 10.8.10

81 Environmental Tech
13550 N Highway 93
Las Vegas, NV 89165

Ticket Type: INBOUND INVOICE

Ticket Number: 2158
Date: 10/08/2010
Time In: 2:19 pm
Time Out: 2:53 pm

Customer: 001011 - NGE, LLC c/o Northgate Environ Mgmt

Vehicle/Container: 72010P
Contract: Northgate Env. On Site Soils 3825 11
Comment: 3825-10-11244

Gross Weight: 130,860 LB Manual In
Tare Weight: 52,600 LB Manual Out
Net Weight: 78260 LB
Net Tons: 39.13

BOL: 12239

Origin	Yards	Material	Billing	Quantity
Not Applicable	0.00 YD	SW CONTAMINATED SOIL	39.13	TN

Driver: 

Weighmaster: 

IN - JORDADE OUT - GUILFDE

Indemnification. Customer agrees, by signature above, to indemnify, hold harmless, and defend Republic Services, Inc., its subsidiaries, affiliates, employees, officers and directors from and against any and all liabilities, claims, penalties, forfeitures, suits and the costs and expenses incident thereto, including costs of defense, settlement, and reasonable attorney's fees, which may be incurred, as a result of death or injuries to any person, or damage to any property, contamination of or adverse effects on the environment, caused in whole or in part by the Customer, its employees, or subcontractors in disposing waste at this Facility. In the event Customer delivers Unacceptable Waste (as determined by Republic) Customer agrees to assume all expenses and obligations with the removal and/or resolution of any effects caused by the delivery of such Unacceptable Waste.

Indemnización. Cliente acuerda indemnizar, mantener inmune, y defender Republic Services, Inc., sus subsidiarios, compañías, divisiones, empleados, oficiales y directores contra de cualquiera y de todas responsabilidades, demandas, penas, pérdidas, juicios, pleitos y los costos incidente además, incluyendo costos de defensa, de acuerdo judicial, y de honorarios razonables del abogado, que pueden ser incurridos en, o como resultado de, la muerte o herida personal a cualquier persona, o daños a cualquier característica, propiedad, contaminación de la tierra o efectos ilícitos en esta Facilidad, causado entero o en parte por el cliente, sus empleados, o sus subcontratistas en botar basura en esta Facilidad. En el caso que el Cliente entrega, bota, basura (según lo determinado por Republic) en este Establecimiento basura inaceptable en los reglamentos de este Establecimiento, el Cliente se compromete asumir todos los costos y obligaciones con el retiro y/o la resolución de cualquier dano(s) causado por la entrega de tal basura inaceptable.



NON-HAZARDOUS WASTE MANIFEST

MANIFEST # 12239

GENERATOR INFORMATION

Generator Name: Tronox LLC

Address: P.O. Box 55

City: Henderson County: Clark

State: NV Zip: 89009

Site Location (if different): 560 W. Lake Mead

Henderson, NV 89015 (702) 592-7727

CUSTOMER/BILLING INFORMATION

Billing Name: NGE LLC c/o Northgate Environment Management

Address: 300 Frank Ogawa Plaza, Ste 510

City: Oakland County: Alameda

State: CA Zip: 94612

Republic Services Approval #	Description of Waste	Volume/Weight	Expiration Date	Container Type
38251011244	Soil for disposal		12-31-2011	Tractor with Dump Trailer(s)
	RZ- _____ # _____	39.13		

*Attach Additional Sheet if necessary

I hereby certify that the above-described materials are non-hazardous wastes as defined by 40 CFR 261 or any applicable state law. Further, that the above named materials are properly classified, described, packaged, marked and labeled, and are in proper condition for transportation according to the applicable regulations of the Department of Transportation.

Susan Crowley (Signature) Date Shipped

TRANSPORTER INFORMATION

Transporter Name: Las Vegas Paving

DOT # 191949

Address: 4420 S. Decatur

Truck Number: 97

Las Vegas, NV 89103

Phone Number: (702) 353-4355

I certify no hazardous waste or other regulated substance was knowingly introduced to the waste while in my custody. The waste transported in this vehicle is the waste identified above, to the best of my knowledge.

(Signature) Date Delivered 10-8-10

DISPOSAL SITE INFORMATION

Site Name: Apex Regional Landfill

Phone No. (702) 599-5920

Address: 13550 U.S. Hwy 93 Las Vegas, NV

I hereby acknowledge receipt of the above described materials. (Signature) Date Received 10-8-10

81 Environmental Tech
13550 N Highway 93
Las Vegas, NV 89165

Ticket Type: INBOUND INVOICE

Ticket Number: 2159
Date: 10/08/2010
Time In: 2:23 pm
Time Out: 2:54 pm

Customer: 001011 - NGE, LLC c/o Northgate Environ Mgmt

Vehicle/Container: 85887P
Contract: Northgate Env. On Site Soils 3825 11
Comment: 3825-10-11244

Gross Weight: 128,690 LB Manual In
Tare Weight: 50,560 LB Manual Out
Net Weight: 78130 LB
Net Tons: 39.07

BOL: 12242

Origin	Yards	Material	Billing Quantity
Not Applicable	0.00 YD	SW CONTAMINATED SOIL	39.06 TN

Driver: 

Weighmaster: 

IN - JORDADE OUT - GUILFDE

Indemnification. Customer agrees, by signature above, to indemnify, hold harmless, and defend Republic Services, Inc., its subsidiaries, affiliates, employees, officers and directors from and against any and all liabilities, claims, penalties, forfeitures, suits and the costs and expenses incident thereto, including costs of defense, settlement, and reasonable attorney's fees, which may be incurred, as a result of death or injuries to any person, or damage to any property, contamination of or adverse effects on the environment, caused in whole or in part by the Customer, its employees, or subcontractors in disposing waste at this Facility. In the event Customer delivers Unacceptable Waste (as determined by Republic) Customer agrees to assume all expenses and obligations with the removal and/or resolution of any effects caused by the delivery of such Unacceptable Waste.

Indemnización. Cliente acuerda indemnizar, mantener inmune, y defender Republic Services, Inc., sus subsidiarios, compañías, divisiones, empleados, oficiales y directores contra de cualquiera y de todas responsabilidades, demandas, penas, pérdidas, juicios, pleitos y los costos incidente además, incluyendo costos de defensa, de acuerdo judicial, y de honorarios razonables del abogado, que pueden ser incurridos en, o como resultado de, la muerte o herida personal a cualquier persona, o daños a cualquier característica, propiedad, contaminación de la tierra o efectos ilícitos en esta Facilidad, causado entero o en parte por el cliente, sus empleados, o sus subcontratistas en botar basura en esta Facilidad. En el caso que el Cliente entrega, bota, basura (según lo determinado por Republic) en este Establecimiento basura inaceptable en los reglamentos de este Establecimiento, el Cliente se compromete asumir todos los costos y obligaciones con el retiro y/o la resolución de cualquier dano(s) causado por la entrega de tal basura inaceptable.



NON-HAZARDOUS WASTE MANIFEST

MANIFEST # 12242

GENERATOR INFORMATION

Generator Name: Tronox LLC

Address: P.O. Box 55

City: Henderson County: Clark

State: NV Zip: 89009

Site Location (if different): 560 W. Lake Mead

Henderson, NV 89015 (702) 592-7727

CUSTOMER/BILLING INFORMATION

Billing Name: NGE LLC c/o Northgate Environment Management

Address: 300 Frank Ogawa Plaza, Ste 510

City: Oakland County: Alameda

State: CA Zip: 94612

Republic Services Approval #	Description of Waste	Volume/Weight	Expiration Date	Container Type
38251011244	Soil for disposal		12-31-2011	Tractor with Dump Trailer(s)
	RZ- #	39.87		
		3.00		

*Attach Additional Sheet if necessary

I hereby certify that the above-described materials are non-hazardous wastes as defined by 40 CFR 261 or any applicable state law. Further, that the above named materials are properly classified, described, packaged, marked and labeled, and are in proper condition for transportation according to the applicable regulations of the Department of Transportation.

Susan Crowley

Signature

Generator/Authorized Agent Name

Signature

Date Shipped

TRANSPORTER INFORMATION

Transporter Name: Las Vegas Paving

DOT # 191949

Address: 4420 S. Decatur

Truck Number: R01

Las Vegas, NV 89103

Phone Number: (702) 353-4355

I certify no hazardous waste or other regulated substance was knowingly introduced to the waste while in my custody. The waste transported in this vehicle is the waste identified above, to the best of my knowledge.

Signature

Name of Authorized Agent

Signature

Date Delivered

10-8-10

DISPOSAL SITE INFORMATION

Site Name: Apex Regional Landfill

Phone No. (702) 599-5920

Address: 13550 U.S. Hwy 93 Las Vegas, NV

I hereby acknowledge receipt of the above described materials

Name (Print or Type)

Signature

Signature

Date Received

10-8-10

81 Environmental Tech
13550 N Highway 93
Las Vegas, NV 89165

Ticket Type: INBOUND INVOICE

Ticket Number: 2161
Date: 10/08/2010
Time In: 2:24 pm
Time Out: 2:59 pm

Customer: 001011 - NGE, LLC c/o Northgate Environ Mgmt

Vehicle/Container: 85156P

Gross Weight: 140,060 LB Manual In
Tare Weight: 56,840 LB Manual Out
Net Weight: 83220 LB
Net Tons: 41.61

Contract: Northgate Env. On Site Soils 3825 11
Comment: 3825-10-11244

BOL: 12243

Origin	Yards	Material	Billing	Quantity
Not Applicable	0.00 YD	SW CONTAMINATED SOIL	41.61	TN

Driver: 

Weighmaster: 

IN - JORDADE OUT - GUILFDE

Indemnification. Customer agrees, by signature above, to indemnify, hold harmless, and defend Republic Services, Inc., its subsidiaries, affiliates, employees, officers and directors from and against any and all liabilities, claims, penalties, forfeitures, suits and the costs and expenses incident thereto, including costs of defense, settlement, and reasonable attorney's fees, which may be incurred, as a result of death or injuries to any person, or damage to any property, contamination of or adverse effects on the environment, caused in whole or in part by the Customer, its employees, or subcontractors in disposing waste at this Facility. In the event Customer delivers Unacceptable Waste (as determined by Republic) Customer agrees to assume all expenses and obligations with the removal and/or resolution of any effects caused by the delivery of such Unacceptable Waste.

Indemnización. Cliente acuerda indemnizar, mantener inmune, y defender Republic Services, Inc., sus subsidiarios, compañías, divisiones, empleados, oficiales y directores contra de cualquiera y de todas responsabilidades, demandas, penas, pérdidas, juicios, pleitos y los costos incidente además, incluyendo costos de defensa, de acuerdo judicial, y de honorarios razonables del abogado, que pueden ser incurridos en, o como resultado de, la muerte o herida personal a cualquier persona, o daños a cualquier característica, propiedad, contaminación de la tierra o efectos ilícitos en esta Facilidad, causado entero o en parte por el cliente, sus empleados, o sus subcontratistas en botar basura en esta Facilidad. En el caso que el Cliente entrega, bota, basura (según lo determinado por Republic) en este Establecimiento basura inaceptable en los reglamentos de este Establecimiento, el Cliente se compromete asumir todos los costos y obligaciones con el retiro y/o la resolución de cualquier dano(s) causado por la entrega de tal basura inaceptable.



NON-HAZARDOUS WASTE MANIFEST

MANIFEST # 12243

GENERATOR INFORMATION

Generator Name: Tronox LLC

Address: P.O. Box 55

City: Henderson County: Clark

State: NV Zip: 89009

Site Location (if different): 560 W. Lake Mead

Henderson, NV 89015 (702) 592-7727

CUSTOMER/BILLING INFORMATION

Billing Name: NGE LLC c/o Northgate Environment Management

Address: 300 Frank Ogawa Plaza, Ste 510

City: Oakland County: Alameda

State: CA Zip: 94612

Republic Services Approval #	Description of Waste	Volume/Weight	Expiration Date	Container Type
38251011244	Soil for disposal		12-31-2011	Tractor with Dump Trailer(s)
	RZ- #	41.61		

*Attach Additional Sheet if necessary.

I hereby certify that the above-described materials are non-hazardous wastes as defined by 40 CFR 261 or any applicable state law. Further, that the above named materials are properly classified, described, packaged, marked and labeled, and are in proper condition for transportation according to the applicable regulations of the Department of Transportation.

Susan Crowley (Signature) Date Shipped

TRANSPORTER INFORMATION

Transporter Name: Las Vegas Paving

DOT # 191949

Address: 4420 S. Decatur

Truck Number: 44

Las Vegas, NV 89103

Phone Number: (702) 353-4355

I certify no hazardous waste or other regulated substance was knowingly introduced to the waste while in my custody. The waste transported in this vehicle is the waste identified above, to the best of my knowledge.

(Signature) Date Delivered: 10-8-10

DISPOSAL SITE INFORMATION

Site Name: Apex Regional Landfill

Phone No. (702) 599-5920

Address: 13550 U.S. Hwy 93 Las Vegas, NV

I hereby acknowledge receipt of the above described materials (Signature) Date Received: 10-8-10

81 Environmental Tech
13550 N Highway 93
Las Vegas, NV 89165

Ticket Type: INBOUND INVOICE

Ticket Number: 2162
Date: 10/08/2010
Time In: 2:37 pm
Time Out: 3:06 pm

Customer: 001011 - NGE, LLC c/o Northgate Environ Mgmt

Vehicle/Container: 82515P
Contract: Northgate Env. On Site Soils 3825 1/
Comment: 144

Gross Weight: 131,500 LB Manual In
Tare Weight: 53,000 LB Manual Out
Net Weight: 78500 LB
Net Tons: 39.25

BOL: 12245

Origin	Yards	Material	Billing Quantity
Not Applicable	0.00 YD	SW CONTAMINATED SOIL	39.25 TN

Driver:

A. Weid 144

Weighmaster:

J. J. J.

JORDADE

Indemnification. Customer agrees, by signature above, to indemnify, hold harmless, and defend Republic Services, Inc., its subsidiaries, affiliates, employees, officers and directors from and against any and all liabilities, claims, penalties, forfeitures, suits and the costs and expenses incident thereto, including costs of defense, settlement, and reasonable attorney's fees, which may be incurred, as a result of death or injuries to any person, or damage to any property, contamination of or adverse effects on the environment, caused in whole or in part by the Customer, its employees, or subcontractors in disposing waste at this Facility. In the event Customer delivers Unacceptable Waste (as determined by Republic) Customer agrees to assume all expenses and obligations with the removal and/or resolution of any effects caused by the delivery of such Unacceptable Waste.

Indemnización. Cliente acuerda indemnizar, mantener inmune, y defender Republic Services, Inc., sus subsidiarios, compañías, divisiones, empleados, oficiales y directores contra de cualquiera y de todas responsabilidades, demandas, penas, pérdidas, juicios, pleitos y los costos incidente además, incluyendo costos de defensa, de acuerdo judicial, y de honorarios razonables del abogado, que pueden ser incurridos en, o como resultado de, la muerte o herida personal a cualquier persona, o daños a cualquier característica, propiedad, contaminación de la tierra o efectos ilícitos en esta Facilidad, causado entero o en parte por el cliente, sus empleados, o sus subcontratistas en botar basura en esta Facilidad. En el caso que el Cliente entrega, bota, basura (según lo determinado por Republic) en este Establecimiento basura inaceptable en los reglamentos de este Establecimiento, el Cliente se compromete asumir todos los costos y obligaciones con el retiro y/o la resolución de cualquier dano(s) causado por la entrega de tal basura inaceptable.



NON-HAZARDOUS WASTE MANIFEST

MANIFEST # 12245

GENERATOR INFORMATION

Generator Name: Tronox LLC

Address: P.O. Box 55

City: Henderson County: Clark

State: NV Zip: 89009

Site Location (if different): 560 W. Lake Mead

Henderson, NV 89015 (702) 592-7727

CUSTOMER/BILLING INFORMATION

Billing Name: NGE LLC c/o Northgate Environment Management

Address: 300 Frank Ogawa Plaza, Ste 510

City: Oakland County: Alameda

State: CA Zip: 94612

Republic Services Approval #	Description of Waste	Volume/Weight	Expiration Date	Container Type
38251011244	Soil for disposal		12-31-2011	Tractor with Dump Trailer(s)
	RZ- _____ # _____	39.25		

*Attach Additional Sheet if necessary

I hereby certify that the above-described materials are non-hazardous wastes as defined by 40 CFR 261 or any applicable state law. Further, that the above named materials are properly classified, described, packaged, marked and labeled, and are in proper condition for transportation according to the applicable regulations of the Department of Transportation.

Susan Crowley

Signature: [Handwritten Signature]

Generator/Authorized Agent Name

Signature

Date Shipped

TRANSPORTER INFORMATION

Transporter Name: Las Vegas Paving

DOT # 191949

Address: 4420 S. Decatur

Truck Number: 144

Las Vegas, NV 89103

Phone Number: (702) 353-4355

I certify no hazardous waste or other regulated substance was knowingly introduced to the waste while in my custody. The waste transported in this vehicle is the waste identified above, to the best of my knowledge.

Signature: [Handwritten Signature]

Date Delivered: 10-8-10

Name of Authorized Agent

Signature

Date Delivered

DISPOSAL SITE INFORMATION

Site Name: Apex Regional Landfill

Phone No. (702) 599-5920

Address: 13550 U.S. Hwy 93 Las Vegas, NV

I hereby acknowledge receipt of the above described materials.

Name (Print or Type): [Handwritten Name]

Signature: [Handwritten Signature]

Date Received: 10-8-10

Date Received

81 Environmental Tech
13550 N Highway 93
Las Vegas, NV 89165

Ticket Type: INBOUND INVOICE

Ticket Number: 2163
Date: 10/08/2010
Time In: 2:37 pm
Time Out: 3:08 pm

Customer: 001011 - NGE, LLC c/o Northgate Environ Mgmt

Vehicle/Container: 66925P
Contract: Northgate Env. On Site Soils 3825 11
Comment: 3825-10-11244

Gross Weight: 124,440 LB Manual In
Tare Weight: 53,200 LB Manual Out
Net Weight: 71,240 LB
Net Tons: 35.62

BOL: 12244

Origin	Yards	Material	Billing Quantity
Not Applicable	0.00 YD	SW CONTAMINATED SOIL	35.62 TN

Driver: _____

Weighmaster: _____

IN - JORDADE OUT - GUILFDE

Indemnification. Customer agrees, by signature above, to indemnify, hold harmless, and defend Republic Services, Inc., its subsidiaries, affiliates, employees, officers and directors from and against any and all liabilities, claims, penalties, forfeitures, suits and the costs and expenses incident thereto, including costs of defense, settlement, and reasonable attorney's fees, which may be incurred, as a result of death or injuries to any person, or damage to any property, contamination of or adverse effects on the environment, caused in whole or in part by the Customer, its employees, or subcontractors in disposing waste at this Facility. In the event Customer delivers Unacceptable Waste (as determined by Republic) Customer agrees to assume all expenses and obligations with the removal and/or resolution of any effects caused by the delivery of such Unacceptable Waste.

Indemnización. Cliente acuerda indemnizar, mantener inmune, y defender Republic Services, Inc., sus subsidiarios, companias, divisiones, empleados, oficiales y directores contra de cualquiera y de todas responsabilidades, demandas, penas, pérdidas, juicios, pleitos y los costos incidente además, incluyendo costos de defensa, de acuerdo judicial, y de honorarios razonables del abogado, que pueden ser incurridos en, o como resultado de, la muerte o herida personal a cualquier persona, o daños a cualquier característica, propiedad, contaminación de la tierra o efectos ilicitos en esta Facilidat, causado entero o en parte por el cliente, sus empleados, o sus subcontratistas en botar basura en esta Facilidat. En el caso que el Cliente entrega, bota, basura (según lo determinado por Republic) en este Establecimiento basura inaceptable en los reglamentos de este Establecimiento, el Cliente se compromete asumir todos los costos y obligaciones con el retiro y/o la resolución de cualquier dano(s) causado por la entrega de tal basura inaceptable.



NON-HAZARDOUS WASTE MANIFEST

MANIFEST # 12244

GENERATOR INFORMATION

Generator Name: Tronox LLC

Address: P.O. Box 55

City: Henderson County: Clark

State: NV Zip: 89009

Site Location (if different): 560 W. Lake Mead

Henderson, NV 89015 (702) 592-7727

CUSTOMER/BILLING INFORMATION

Billing Name: NGE LLC c/o Northgate Environment Management

Address: 300 Frank Ogawa Plaza, Ste 510

City: Oakland County: Alameda

State: CA Zip: 94612

Republic Services Approval #	Description of Waste	Volume/Weight	Expiration Date	Container Type
38251011244	Soil for disposal		12-31-2011	Tractor with Dump Trailer(s)
	RZ- _____ # _____	35.62		

*Attach Additional Sheet if necessary

I hereby certify that the above-described materials are non-hazardous wastes as defined by 40 CFR 261 or any applicable state law. Further, that the above named materials are properly classified, described, packaged, marked and labeled, and are in proper condition for transportation according to the applicable regulations of the Department of Transportation.

Susan Crowley

Susan Crowley

Generator/Authorized Agent Name

Signature

Date Shipped

TRANSPORTER INFORMATION

Transporter Name: Las Vegas Paving

DOT # 191949

Address: 4420 S. Decatur

Truck Number: 55

Las Vegas, NV 89103

Phone Number: (702) 353-4355

I certify no hazardous waste or other regulated substance was knowingly introduced to the waste while in my custody. The waste transported in this vehicle is the waste identified above, to the best of my knowledge.

[Signature]

10-8-10

Name of Authorized Agent

Signature

Date Delivered

DISPOSAL SITE INFORMATION

Site Name: Apex Regional Landfill

Phone No. (702) 599-5920

Address: 13550 U.S. Hwy 93 Las Vegas, NV

Thereby acknowledge receipt of the above described materials

[Signature]

10-8-10

Name (Print or Type)

Signature

Date Received

JH

81 Environmental Tech
13550 N Highway 93
Las Vegas, NV 89165

Ticket Type: INBOUND INVOICE

Ticket Number: 2164
Date: 10/08/2010
Time In: 2:17 pm
Time Out: 3:15 pm

Customer: 001011 - NGE, LLC c/o Northgate Environ Mgmt

Vehicle/Container: 71893P

Contract: Northgate Env. On Site Soils 3825 11
Comment: 3825-10-11244

Gross Weight: 131,520 LB Manual In
Tare Weight: 57,800 LB Manual Out
Net Weight: 73,720 LB
Net Tons: 36.86

121,820

53,120
68,700

BOL: 12240 12234

Origin	Yards	Material	Billing Quantity
Not Applicable	0.00 YD	SW CONTAMINATED SOIL	36.86 TN

34.35 TN

Driver: *Robert Adams*

Weighmaster: *[Signature]*

GUILFDE

Indemnification. Customer agrees, by signature above, to indemnify, hold harmless, and defend Republic Services, Inc., its subsidiaries, affiliates, employees, officers and directors from and against any and all liabilities, claims, penalties, forfeitures, suits and the costs and expenses incident thereto, including costs of defense, settlement, and reasonable attorney's fees, which may be incurred, as a result of death or injuries to any person, or damage to any property, contamination of or adverse effects on the environment, caused in whole or in part by the Customer, its employees, or subcontractors in disposing waste at this Facility. In the event Customer delivers Unacceptable Waste (as determined by Republic) Customer agrees to assume all expenses and obligations with the removal and/or resolution of any effects caused by the delivery of such Unacceptable Waste.

Indemnización. Cliente acuerda indemnizar, mantener inmune, y defender Republic Services, Inc., sus subsidiarios, companias, divisiones, empleados, oficiales y directores contra de cualquiera y de todas responsabilidades, demandas, penas, pérdidas, juicios, pleitos y los costos incidente además, incluyendo costos de defensa, de acuerdo judicial, y de honorarios razonables del abogado, que pueden ser incurridos en, o como resultado de, la muerte o herida personal a cualquier persona, o daños a cualquier característica, propiedad, contaminación de la tierra o efectos ilicitos en esta Facilidad, causado entero o en parte por el cliente, sus empleados, o sus subcontratistas en botar basura en esta Facilidad. En el caso que el Cliente entrega, bota, basura (según lo determinado por Republic) en este Establecimiento basura inaceptable en los reglamentos de este Establecimiento, el Cliente se compromete asumir todos los costos y obligaciones con el retiro y/o la resolución de cualquier dano(s) causado por la entrega de tal basura inaceptable.



NON-HAZARDOUS WASTE MANIFEST

MANIFEST # 12234

GENERATOR INFORMATION

Generator Name: Tronox LLC
Address: P.O. Box 55
City: Henderson County: Clark
State: NV Zip: 89009
Site Location (if different): 560 W. Lake Mead
Henderson, NV 89015 (702) 592-7727

CUSTOMER/BILLING INFORMATION

Billing Name: NGE LLC c/o Northgate Environment Management
Address: 300 Frank Ogawa Plaza, Ste 510
City: Oakland County: Alameda
State: CA Zip: 94612

Table with 5 columns: Republic Services Approval #, Description of Waste, Volume/Weight, Expiration Date, Container Type. Row 1: 38251011244, Soil for disposal, 34.35 TN, 12-31-2011, Tractor with Dump Trailer(s).

*Attach Additional Sheet if necessary

I hereby certify that the above-described materials are non-hazardous wastes as defined by 40 CFR 261 or any applicable state law. Further, that the above named materials are properly classified, described, packaged, marked and labeled, and are in proper condition for transportation according to the applicable regulations of the Department of Transportation.

Susan Crowley
Generator/Authorized Agent Name Signature Date Shipped

TRANSPORTER INFORMATION

Transporter Name: Las Vegas Paving DOT # 191949
Address: 4420 S. Decatur Truck Number: 07 JH
Las Vegas, NV 89103 Phone Number: (702) 353-4355

I certify no hazardous waste or other regulated substance was knowingly introduced to the waste while in my custody. The waste transported in this vehicle is the waste identified above, to the best of my knowledge.

Cristino Medina
Name of Authorized Agent Signature Date Delivered 10-8-10

DISPOSAL SITE INFORMATION

Site Name: Apex Regional Landfill Phone No. (702) 599-5920
Address: 13550 U.S. Hwy 93 Las Vegas, NV

I hereby acknowledge receipt of the above described materials
Name (Print or Type) Signature Date Received 10-8-10

81 Environmental Tech
13550 N Highway 93
Las Vegas, NV 89165

Ticket Type: INBOUND INVOICE

Ticket Number: 2165
Date: 10/08/2010
Time In: 2:58 pm
Time Out: 3:17 pm

Customer: 001011 - NGE, LLC c/o Northgate Environ Mgmt

Vehicle/Container: 81495P
Contract: Northgate Env. On Site Soils 3825 11
Comment: 3825-10-11244

Gross Weight: 112,020 LB Manual In
Tare Weight: 46,300 LB Manual Out
Net Weight: 65720 LB
Net Tons: 32.86

BOL: 12246

Origin	Yards	Material	Billing	Quantity
Not Applicable	0.00 YD	SW CONTAMINATED SOIL	32.86	TN

Driver: _____

Weighmaster: _____

IN - JORDADE OUT - GUILFDE

Indemnification. Customer agrees, by signature above, to indemnify, hold harmless, and defend Republic Services, Inc., its subsidiaries, affiliates, employees, officers and directors from and against any and all liabilities, claims, penalties, forfeitures, suits and the costs and expenses incident thereto, including costs of defense, settlement, and reasonable attorney's fees, which may be incurred, as a result of death or injuries to any person, or damage to any property, contamination of or adverse effects on the environment, caused in whole or in part by the Customer, its employees, or subcontractors in disposing waste at this Facility. In the event Customer delivers Unacceptable Waste (as determined by Republic) Customer agrees to assume all expenses and obligations with the removal and/or resolution of any effects caused by the delivery of such Unacceptable Waste.

Indemnización. Cliente acuerda indemnizar, mantener inmune, y defender Republic Services, Inc., sus subsidiarios, compañías, divisiones, empleados, oficiales y directores contra de cualquiera y de todas responsabilidades, demandas, penas, pérdidas, juicios, pleitos y los costos incidente además, incluyendo costos de defensa, de acuerdo judicial, y de honorarios razonables del abogado, que pueden ser incurridos en, o como resultado de, la muerte o herida personal a cualquier persona, o daños a cualquier característica, propiedad, contaminación de la tierra o efectos ilícitos en esta Facilidad, causado entero o en parte por el cliente, sus empleados, o sus subcontratistas en botar basura en esta Facilidad. En el caso que el Cliente entrega, bota, basura (según lo determinado por Republic) en este Establecimiento basura inaceptable en los reglamentos de este Establecimiento, el Cliente se compromete asumir todos los costos y obligaciones con el retiro y/o la resolución de cualquier dano(s) causado por la entrega de tal basura inaceptable.



NON-HAZARDOUS WASTE MANIFEST

MANIFEST # 12245

GENERATOR INFORMATION

Generator Name: Tronox LLC

Address: P.O. Box 55

City: Henderson County: Clark

State: NV Zip: 89009

Site Location (if different): 560 W. Lake Mead

Henderson, NV 89015 (702) 592-7727

CUSTOMER/BILLING INFORMATION

Billing Name: NGE LLC c/o Northgate Environment Management

Address: 300 Frank Ogawa Plaza, Ste 510

City: Oakland County: Alameda

State: CA Zip: 94612

Republic Services Approval #	Description of Waste	Volume/Weight	Expiration Date	Container Type
38251011244	Soil for disposal		12-31-2011	Tractor with Dump Trailer(s)
	RZ- #	32.86		

*Attach Additional Sheet if necessary

I hereby certify that the above-described materials are non-hazardous wastes as defined by 40 CFR 261 or any applicable state law. Further, that the above named materials are properly classified, described, packaged, marked and labeled, and are in proper condition for transportation according to the applicable regulations of the Department of Transportation.

Susan Crowley Generator/Authorized Agent Name Signature Date Shipped

TRANSPORTER INFORMATION

Transporter Name: Las Vegas Paving

DOT # 191949

Address: 4420 S. Decatur

Truck Number: 175

Las Vegas, NV 89103

Phone Number: (702) 353-4355

I certify no hazardous waste or other regulated substance was knowingly introduced to the waste while in my custody. The waste transported in this vehicle is the waste identified above, to the best of my knowledge.

Andrew Walker Name of Authorized Agent Signature Date Delivered 10-8-10

DISPOSAL SITE INFORMATION

Site Name: Apex Regional Landfill

Phone No. (702) 599-5920

Address: 13550 U.S. Hwy 93 Las Vegas, NV

I hereby acknowledge receipt of the above described materials Name (Print or Type) Signature Date Received 10-8-10

81 Environmental Tech
13550 N Highway 93
Las Vegas, NV 89165

Ticket Type: INBOUND INVOICE

Ticket Number: 2166
Date: 10/08/2010
Time In: 3:02 pm
Time Out: 3:27 pm

Customer: 001011 - NGE, LLC c/o Northgate Environ Mgmt

Vehicle/Container: 73083P
Contract: Northgate Env. On Site Soils 3825 11
Comment: 3825-10-11244

Gross Weight: 136,520 LB Manual In
Tare Weight: 57,260 LB Manual Out
Net Weight: 79,260 LB
Net Tons: 39.63

BOL: 12247

Origin	Yards	Material	Billing	Quantity
Not Applicable	0.00 YD	SW CONTAMINATED SOIL	39.63 TN	

Driver: _____

Weighmaster: _____

IN - JORDADE OUT - GUILFDE

Indemnification. Customer agrees, by signature above, to indemnify, hold harmless, and defend Republic Services, Inc., its subsidiaries, affiliates, employees, officers and directors from and against any and all liabilities, claims, penalties, forfeitures, suits and the costs and expenses incident thereto, including costs of defense, settlement, and reasonable attorney's fees, which may be incurred, as a result of death or injuries to any person, or damage to any property, contamination of or adverse effects on the environment, caused in whole or in part by the Customer, its employees, or subcontractors in disposing waste at this Facility. In the event Customer delivers Unacceptable Waste (as determined by Republic) Customer agrees to assume all expenses and obligations with the removal and/or resolution of any effects caused by the delivery of such Unacceptable Waste.

Indemnización. Cliente acuerda indemnizar, mantener inmune, y defender Republic Services, Inc., sus subsidiarios, compañías, divisiones, empleados, oficiales y directores contra de cualquiera y de todas responsabilidades, demandas, penas, pérdidas, juicios, pleitos y los costos incidente además, incluyendo costos de defensa, de acuerdo judicial, y de honorarios razonables del abogado, que pueden ser incurridos en, o como resultado de, la muerte o herida personal a cualquier persona, o daños a cualquier característica, propiedad, contaminación de la tierra o efectos ilícitos en esta Facilidad, causado entero o en parte por el cliente, sus empleados, o sus subcontratistas en botar basura en esta Facilidad. En el caso que el Cliente entrega, bota, basura (según lo determinado por Republic) en este Establecimiento basura inaceptable en los reglamentos de este Establecimiento, el Cliente se compromete asumir todos los costos y obligaciones con el retiro y/o la resolución de cualquier dano(s) causado por la entrega de tal basura inaceptable.

81 Environmental Tech
13550 N Highway 93
Las Vegas, NV 89165

Ticket Type: INBOUND INVOICE

Ticket Number: 2167
Date: 10/08/2010
Time In: 3:05 pm
Time Out: 3:30 pm

Customer: 001011 - NGE, LLC c/o Northgate Environ Mgmt

Vehicle/Container: 84893P
Contract: Northgate Env. On Site Soils 3825 11
Comment: 3825-10-11244

Gross Weight: 130,520 LB Manual In
Tare Weight: 53,260 LB Manual Out
Net Weight: 77,260 LB
Net Tons: 38.63

BOL: 12248

Origin	Yards	Material	Billing Quantity
Not Applicable	0.00 YD	SW CONTAMINATED SOIL	38.63 TN

Driver: _____

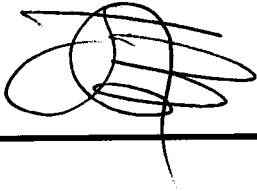

Weighmaster: _____

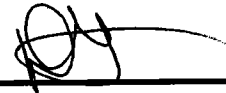

IN - JORDADE OUT - GUILFDE

Indemnification. Customer agrees, by signature above, to indemnify, hold harmless, and defend Republic Services, Inc., its subsidiaries, affiliates, employees, officers and directors from and against any and all liabilities, claims, penalties, forfeitures, suits and the costs and expenses incident thereto, including costs of defense, settlement, and reasonable attorney's fees, which may be incurred, as a result of death or injuries to any person, or damage to any property, contamination of or adverse effects on the environment, caused in whole or in part by the Customer, its employees, or subcontractors in disposing waste at this Facility. In the event Customer delivers Unacceptable Waste (as determined by Republic) Customer agrees to assume all expenses and obligations with the removal and/or resolution of any effects caused by the delivery of such Unacceptable Waste.

Indemnización. Cliente acuerda indemnizar, mantener inmune, y defender Republic Services, Inc., sus subsidiarios, compañías, divisiones, empleados, oficiales y directores contra de cualquiera y de todas responsabilidades, demandas, penas, pérdidas, juicios, pleitos y los costos incidente además, incluyendo costos de defensa, de acuerdo judicial, y de honorarios razonables del abogado, que pueden ser incurridos en, o como resultado de, la muerte o herida personal a cualquier persona, o daños a cualquier característica, propiedad, contaminación de la tierra o efectos ilícitos en esta Facilidad, causado entero o en parte por el cliente, sus empleados, o sus subcontratistas en botar basura en esta Facilidad. En el caso que el Cliente entrega, bota, basura (según lo determinado por Republic) en este Establecimiento basura inaceptable en los reglamentos de este Establecimiento, el Cliente se compromete asumir todos los costos y obligaciones con el retiro y/o la resolución de cualquier dano(s) causado por la entrega de tal basura inaceptable.



NON-HAZARDOUS WASTE MANIFEST

MANIFEST # 12248

GENERATOR INFORMATION

Generator Name: Tronox LLC
Address: P.O. Box 55
City: Henderson County: Clark
State: NV Zip: 89009
Site Location (if different): 560 W. Lake Mead
Henderson, NV 89015 (702) 592-7727

CUSTOMER/BILLING INFORMATION

Billing Name: NGE LLC c/o Northgate Environment Management
Address: 300 Frank Ogawa Plaza, Ste 510
City: Oakland County: Alameda
State: CA Zip: 94612

Table with 5 columns: Republic Services Approval #, Description of Waste, Volume/Weight, Expiration Date, Container Type. Row 1: 38251011244, Soil for disposal, 38.63, 12-31-2011, Tractor with Dump Trailer(s).

*Attach Additional Sheet if necessary

I hereby certify that the above-described materials are non-hazardous wastes as defined by 40 CFR 261 or any applicable state law. Further, that the above named materials are properly classified, described, packaged, marked and labeled, and are in proper condition for transportation according to the applicable regulations of the Department of Transportation.

Susan Crowley
Generator/Authorized Agent Name Signature Date Shipped

TRANSPORTER INFORMATION

Transporter Name: Las Vegas Paving DOT # 191949
Address: 4420 S. Decatur Truck Number: BRAVO 303
Las Vegas, NV 89103 Phone Number: (702) 353-4355

I certify no hazardous waste or other regulated substance was knowingly introduced to the waste while in my custody. The waste transported in this vehicle is the waste identified above, to the best of my knowledge.

Name of Authorized Agent Signature Date Delivered 10-8-10

DISPOSAL SITE INFORMATION

Site Name: Apex Regional Landfill Phone No. (702) 599-5920
Address: 13550 U.S. Hwy 93 Las Vegas, NV

I hereby acknowledge receipt of the above described materials
Name (Print or Type) Signature Date Received 10-8-10

81 Environmental Tech
13550 N Highway 93
Las Vegas, NV 89165

Ticket Type: INBOUND INVOICE

Ticket Number: 2168
Date: 10/08/2010
Time In: 3:06 pm
Time Out: 3:32 pm

Customer: 001011 - NGE, LLC c/o Northgate Environ Mgmt

Vehicle/Container: 81494P
Contract: Northgate Env. On Site Soils 3825 11
Comment: 3825-10-11244

Gross Weight: 112,860 LB Manual In
Tare Weight: 41,040 LB Manual Out
Net Weight: 71,820 LB
Net Tons: 35.91

BOL: 12249

Origin	Yards	Material	Billing Quantity
Not Applicable	0.00 YD	SW CONTAMINATED SOIL	35.91 TN

Driver: _____

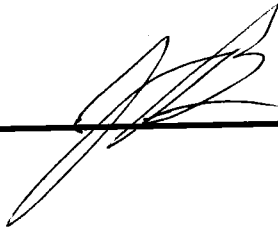

Weighmaster: _____



IN - JORDADE OUT - GUILFDE

Indemnification. Customer agrees, by signature above, to indemnify, hold harmless, and defend Republic Services, Inc., its subsidiaries, affiliates, employees, officers and directors from and against any and all liabilities, claims, penalties, forfeitures, suits and the costs and expenses incident thereto, including costs of defense, settlement, and reasonable attorney's fees, which may be incurred, as a result of death or injuries to any person, or damage to any property, contamination of or adverse effects on the environment, caused in whole or in part by the Customer, its employees, or subcontractors in disposing waste at this Facility. In the event Customer delivers Unacceptable Waste (as determined by Republic) Customer agrees to assume all expenses and obligations with the removal and/or resolution of any effects caused by the delivery of such Unacceptable Waste.

Indemnización. Cliente acuerda indemnizar, mantener inmune, y defender Republic Services, Inc., sus subsidiarios, compañías, divisiones, empleados, oficiales y directores contra de cualquiera y de todas responsabilidades, demandas, penas, pérdidas, juicios, pleitos y los costos incidente además, incluyendo costos de defensa, de acuerdo judicial, y de honorarios razonables del abogado, que pueden ser incurridos en, o como resultado de, la muerte o herida personal a cualquier persona, o daños a cualquier característica, propiedad, contaminación de la tierra o efectos ilícitos en esta Facilidad, causado entero o en parte por el cliente, sus empleados, o sus subcontratistas en botar basura en esta Facilidad. En el caso que el Cliente entrega, bota, basura (según lo determinado por Republic) en este Establecimiento basura inaceptable en los reglamentos de este Establecimiento, el Cliente se compromete asumir todos los costos y obligaciones con el retiro y/o la resolución de cualquier dano(s) causado por la entrega de tal basura inaceptable.



NON-HAZARDOUS WASTE MANIFEST

MANIFEST # 12249

GENERATOR INFORMATION

Generator Name: Tronox LLC

Address: P.O. Box 55

City: Henderson County: Clark

State: NV Zip: 89009

Site Location (if different): 560 W. Lake Mead

Henderson, NV 89015 (702) 592-7727

CUSTOMER/BILLING INFORMATION

Billing Name: NGE LLC c/o Northgate Environment Management

Address: 300 Frank Ogawa Plaza, Ste 510

City: Oakland County: Alameda

State: CA Zip: 94612

Republic Services Approval #	Description of Waste	Volume/Weight	Expiration Date	Container Type
38251011244	Soil for disposal		12-31-2011	Tractor with Dump Trailer(s)
	RZ- #	3591		

*Attach Additional Sheet if necessary

I hereby certify that the above-described materials are non-hazardous wastes as defined by 40 CFR 261 or any applicable state law. Further, that the above named materials are properly classified, described, packaged, marked and labeled, and are in proper condition for transportation according to the applicable regulations of the Department of Transportation.

Susan Crowley Generator/Authorized Agent Name Signature Date Shipped

TRANSPORTER INFORMATION

Transporter Name: Las Vegas Paving

DOT # 191949

Address: 4420 S. Decatur

Truck Number: 125

Las Vegas, NV 89103

Phone Number: (702) 353-4355

I certify no hazardous waste or other regulated substance was knowingly introduced to the waste while in my custody. The waste transported in this vehicle is the waste identified above, to the best of my knowledge.

J Bowyer Name of Authorized Agent Signature Date Delivered 10-8-10

DISPOSAL SITE INFORMATION

Site Name: Apex Regional Landfill

Phone No. (702) 599-5920

Address: 13550 U.S. Hwy 93 Las Vegas, NV

I hereby acknowledge receipt of the above described materials Name (Print or Type) Signature Date Received 10-8-10

81 Environmental Tech
13550 N Highway 93
Las Vegas, NV 89165

Ticket Type: INBOUND INVOICE

Ticket Number: 2169
Date: 10/08/2010
Time In: 3:17 pm
Time Out: 3:42 pm

Customer: 001011 - NGE, LLC c/o Northgate Environ Mgmt

Vehicle/Container: 73072P

Contract: Northgate Env. On Site Soils 3825 11

Comment: 3825-10-11244

Gross Weight: 130,040 LB Manual In
Tare Weight: 50,020 LB Manual Out
Net Weight: 80020 LB
Net Tons: 40.01

BOL: 12250

Origin	Yards	Material	Billing	Quantity
Not Applicable	0.00 YD	SW CONTAMINATED SOIL	40.01	TN

Driver: 

Weighmaster: 

IN - JORDADE OUT - GUILFDE

Indemnification. Customer agrees, by signature above, to indemnify, hold harmless, and defend Republic Services, Inc., its subsidiaries, affiliates, employees, officers and directors from and against any and all liabilities, claims, penalties, forfeitures, suits and the costs and expenses incident thereto, including costs of defense, settlement, and reasonable attorney's fees, which may be incurred, as a result of death or injuries to any person, or damage to any property, contamination of or adverse effects on the environment, caused in whole or in part by the Customer, its employees, or subcontractors in disposing waste at this Facility. In the event Customer delivers Unacceptable Waste (as determined by Republic) Customer agrees to assume all expenses and obligations with the removal and/or resolution of any effects caused by the delivery of such Unacceptable Waste.

Indemnización. Cliente acuerda indemnizar, mantener inmune, y defender Republic Services, Inc., sus subsidiarios, compañías, divisiones, empleados, oficiales y directores contra de cualquiera y de todas responsabilidades, demandas, penas, pérdidas, juicios, pleitos y los costos incidente además, incluyendo costos de defensa, de acuerdo judicial, y de honorarios razonables del abogado, que pueden ser incurridos en, o como resultado de, la muerte o herida personal a cualquier persona, o daños a cualquier característica, propiedad, contaminación de la tierra o efectos ilícitos en esta Facilidad, causado entero o en parte por el cliente, sus empleados, o sus subcontratistas en botar basura en esta Facilidad. En el caso que el Cliente entrega, botá, basura (según lo determinado por Republic) en este Establecimiento basura inaceptable en los reglamentos de este Establecimiento, el Cliente se compromete asumir todos los costos y obligaciones con el retiro y/o la resolución de cualquier dano(s) causado por la entrega de tal basura inaceptable.



NON-HAZARDOUS WASTE MANIFEST

MANIFEST # 12250

GENERATOR INFORMATION

Generator Name: Tronox LLC
 Address: P.O. Box 55
 City: Henderson County: Clark
 State: NV Zip: 89009
 Site Location (if different): 560 W. Lake Mead
Henderson, NV 89015 (702) 592-7727

CUSTOMER/BILLING INFORMATION

Billing Name: NGE LLC c/o Northgate Environment Management
 Address: 300 Frank Ogawa Plaza, Ste 510
 City: Oakland County: Alameda
 State: CA Zip: 94612

Republic Services Approval #	Description of Waste	Volume/Weight	Expiration Date	Container Type
38251011244	Soil for disposal		12-31-2011	Tractor with Dump Trailer(s)
	RZ- _____ # _____	40.01		

*Attach Additional Sheet if necessary

I hereby certify that the above-described materials are non-hazardous wastes as defined by 40 CFR 261 or any applicable state law. Further, that the above named materials are properly classified, described, packaged, marked and labeled, and are in proper condition for transportation according to the applicable regulations of the Department of Transportation.

Susan Crowley [Signature] 10-8-10
 Generator/Authorized Agent Name Signature Date Shipped

TRANSPORTER INFORMATION

Transporter Name: Las Vegas Paving DOT # 191949
 Address: 4420 S. Decatur Truck Number: 135
Las Vegas, NV 89103 Phone Number: (702) 353-4355

I certify no hazardous waste or other regulated substance was knowingly introduced to the waste while in my custody. The waste transported in this vehicle is the waste identified above, to the best of my knowledge.

Robert Lee [Signature] 10-8-10
 Name of Authorized Agent Signature Date Delivered

DISPOSAL SITE INFORMATION

Site Name: Apex Regional Landfill Phone No. (702) 599-5920
 Address: 13550 U.S. Hwy 93 Las Vegas, NV

I hereby acknowledge receipt of the above described materials [Signature] 10-8-10
 Name (Print or Type) Signature Date Received

81 Environmental Tech
13550 N Highway 93
Las Vegas, NV 89165

Ticket Type: INBOUND INVOICE

Ticket Number: 2170
Date: 10/08/2010
Time In: 3:22 pm
Time Out: 3:47 pm

Customer: 001011 - NGE, LLC c/o Northgate Environ Mgmt

Vehicle/Container: 60573P
Contract: Northgate Env. On Site Soils 3825 11
Comment: 38251011244

Gross Weight: 134,060 LB Manual In
Tare Weight: 57,840 LB Manual Out
Net Weight: 76220 LB
Net Tons: 38.11

BOL: 12252

Origin	Yards	Material	Billing	Quantity
Not Applicable	0.00 YD	SW CONTAMINATED SOIL	38.11	TN

Driver: _____



Weighmaster: _____



JORDADE

Indemnification. Customer agrees, by signature above, to indemnify, hold harmless, and defend Republic Services, Inc., its subsidiaries, affiliates, employees, officers and directors from and against any and all liabilities, claims, penalties, forfeitures, suits and the costs and expenses incident thereto, including costs of defense, settlement, and reasonable attorney's fees, which may be incurred, as a result of death or injuries to any person, or damage to any property, contamination of or adverse effects on the environment, caused in whole or in part by the Customer, its employees, or subcontractors in disposing waste at this Facility. In the event Customer delivers Unacceptable Waste (as determined by Republic) Customer agrees to assume all expenses and obligations with the removal and/or resolution of any effects caused by the delivery of such Unacceptable Waste.

Indemnización. Cliente acuerda indemnizar, mantener inmune, y defender Republic Services, Inc., sus subsidiarios, compañías, divisiones, empleados, oficiales y directores contra de cualquiera y de todas responsabilidades, demandas, penas, pérdidas, juicios, pleitos y los costos incidente además, incluyendo costos de defensa, de acuerdo judicial, y de honorarios razonables del abogado, que pueden ser incurridos en, o como resultado de, la muerte o herida personal a cualquier persona, o daños a cualquier característica, propiedad, contaminación de la tierra o efectos ilícitos en esta Facilidad, causado entero o en parte por el cliente, sus empleados, o sus subcontratistas en botar basura en esta Facilidad. En el caso que el Cliente entrega, bota, basura (según lo determinado por Republic) en este Establecimiento basura inaceptable en los reglamentos de este Establecimiento, el Cliente se compromete asumir todos los costos y obligaciones con el retiro y/o la resolución de cualquier dano(s) causado por la entrega de tal basura inaceptable.



NON-HAZARDOUS WASTE MANIFEST

MANIFEST # 12252

GENERATOR INFORMATION

Generator Name: Tronox LLC
Address: P.O. Box 55
City: Henderson County: Clark
State: NV Zip: 89009
Site Location (if different): 560 W. Lake Mead
Henderson, NV 89015 (702) 592-7727

CUSTOMER/BILLING INFORMATION

Billing Name: NGE LLC c/o Northgate Environment Management
Address: 300 Frank Ogawa Plaza, Ste 510
City: Oakland County: Alameda
State: CA Zip: 94612

Table with 5 columns: Republic Services Approval #, Description of Waste, Volume/Weight, Expiration Date, Container Type. Row 1: 38251011244, Soil for disposal, 38.11, 12-31-2011, Tractor with Dump Trailer(s).

*Attach Additional Sheet if necessary

I hereby certify that the above-described materials are non-hazardous wastes as defined by 40 CFR 261 or any applicable state law. Further, that the above named materials are properly classified, described, packaged, marked and labeled, and are in proper condition for transportation according to the applicable regulations of the Department of Transportation.

Susan Crowley (Signature)
Generator/Authorized Agent Name Signature Date Shipped

TRANSPORTER INFORMATION

Transporter Name: Las Vegas Paving DOT # 191949
Address: 4420 S. Decatur Truck Number: 60573P
Las Vegas, NV 89103 Phone Number: (702) 353-4355

I certify no hazardous waste or other regulated substance was knowingly introduced to the waste while in my custody. The waste transported in this vehicle is the waste identified above, to the best of my knowledge.

(Signature) 10-8-10
Name of Authorized Agent Signature Date Delivered

DISPOSAL SITE INFORMATION

Site Name: Apex Regional Landfill Phone No. (702) 599-5920
Address: 13550 U.S. Hwy 93 Las Vegas, NV

I hereby acknowledge receipt of the above described materials
Debra Savol (Signature) 10-8-10
Name (Print or Type) Signature Date Received

81 Environmental Tech
13550 N Highway 93
Las Vegas, NV 89165

Ticket Type: INBOUND INVOICE

Ticket Number: 2172
Date: 10/08/2010
Time In: 3:28 pm
Time Out: 3:55 pm

Customer: 001011 - NGE, LLC c/o Northgate Environ Mgmt

Vehicle/Container: 44264A
Contract: Northgate Env. On Site Soils 3825 10
Comment: 3825-10-11244

Gross Weight: 131,980 LB Manual In
Tare Weight: 55,820 LB Manual Out
Net Weight: 76,160 LB
Net Tons: 38.08

BOL: 12253

Origin	Yards	Material	Billing	Quantity
Not Applicable	0.00 YD	SW CONTAMINATED SOIL	38.08	TN

Driver: 

Weighmaster: 

IN - JORDADE OUT - GUILFDE

Indemnification. Customer agrees, by signature above, to indemnify, hold harmless, and defend Republic Services, Inc., its subsidiaries, affiliates, employees, officers and directors from and against any and all liabilities, claims, penalties, forfeitures, suits and the costs and expenses incident thereto, including costs of defense, settlement, and reasonable attorney's fees, which may be incurred, as a result of death or injuries to any person, or damage to any property, contamination of or adverse effects on the environment, caused in whole or in part by the Customer, its employees, or subcontractors in disposing waste at this Facility. In the event Customer delivers Unacceptable Waste (as determined by Republic) Customer agrees to assume all expenses and obligations with the removal and/or resolution of any effects caused by the delivery of such Unacceptable Waste.

Indemnización. Cliente acuerda indemnizar, mantener inmune, y defender Republic Services, Inc., sus subsidiarios, compañías, divisiones, empleados, oficiales y directores contra de cualquiera y de todas responsabilidades, demandas, penas, pérdidas, juicios, pleitos y los costos incidente además, incluyendo costos de defensa, de acuerdo judicial, y de honorarios razonables del abogado, que pueden ser incurridos en, o como resultado de, la muerte o herida personal a cualquier persona, o daños a cualquier característica, propiedad, contaminación de la tierra o efectos ilícitos en esta Facilidad, causado entero o en parte por el cliente, sus empleados, o sus subcontratistas en botar basura en esta Facilidad. En el caso que el Cliente entrega, bota, basura (según lo determinado por Republic) en este Establecimiento basura inaceptable en los reglamentos de este Establecimiento, el Cliente se compromete asumir todos los costos y obligaciones con el retiro y/o la resolución de cualquier dano(s) causado por la entrega de tal basura inaceptable.



NON-HAZARDOUS WASTE MANIFEST

MANIFEST # 12253

GENERATOR INFORMATION

Generator Name: Tronox LLC
Address: P.O. Box 55
City: Henderson County: Clark
State: NV Zip: 89009
Site Location (if different): 560 W. Lake Mead
Henderson, NV 89015 (702) 592-7727

CUSTOMER/BILLING INFORMATION

Billing Name: NGE LLC c/o Northgate Environment Management
Address: 300 Frank Ogawa Plaza, Ste 510
City: Oakland County: Alameda
State: CA Zip: 94612

Table with 5 columns: Republic Services Approval #, Description of Waste, Volume/Weight, Expiration Date, Container Type. Row 1: 38251011244, Soil for disposal, 38.08, 12-31-2011, Tractor with Dump Trailer(s).

*Attach Additional Sheet if necessary

I hereby certify that the above-described materials are non-hazardous wastes as defined by 40 CFR 261 or any applicable state law. Further, that the above named materials are properly classified, described, packaged, marked and labeled, and are in proper condition for transportation according to the applicable regulations of the Department of Transportation.

Susan Crowley (Signature)
Generator/Authorized Agent Name Signature Date Shipped

TRANSPORTER INFORMATION

Transporter Name: Las Vegas Paving DOT # 191949
Address: 4420 S. Decatur Truck Number: 100
Las Vegas, NV 89103 Phone Number: (702) 353-4355

I certify no hazardous waste or other regulated substance was knowingly introduced to the waste while in my custody. The waste transported in this vehicle is the waste identified above, to the best of my knowledge.

Name of Authorized Agent Signature Date Delivered

DISPOSAL SITE INFORMATION

Site Name: Apex Regional Landfill Phone No. (702) 599-5920
Address: 13550 U.S. Hwy 93 Las Vegas, NV

I hereby acknowledge receipt of the above described materials (Signature)
Name (Print or Type) Signature Date Received

81 Environmental Tech
13550 N Highway 93
Las Vegas, NV 89165

Ticket Type: INBOUND INVOICE

Ticket Number: 2173
Date: 10/08/2010
Time In: 3:21 pm
Time Out: 3:57 pm

Customer: 001011 - NGE, LLC c/o Northgate Environ Mgmt

Vehicle/Container: 81496P
Contract: Northgate Env. On Site Soils 3825 10
Comment: 3825-10-11244

Gross Weight: 114,260 LB Manual In
Tare Weight: 30,680 LB Manual Out
Net Weight: 83580 LB
Net Tons: 41.79

BOL: 12251

Origin	Yards	Material	Billing Quantity
Not Applicable	0.00 YD	SW CONTAMINATED SOIL	41.79 TN

Driver: _____



Weighmaster: _____

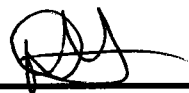

IN - JORDADE OUT - GUILFDE

Indemnification. Customer agrees, by signature above, to indemnify, hold harmless, and defend Republic Services, Inc., its subsidiaries, affiliates, employees, officers and directors from and against any and all liabilities, claims, penalties, forfeitures, suits and the costs and expenses incident thereto, including costs of defense, settlement, and reasonable attorney's fees, which may be incurred, as a result of death or injuries to any person, or damage to any property, contamination of or adverse effects on the environment, caused in whole or in part by the Customer, its employees, or subcontractors in disposing waste at this Facility. In the event Customer delivers Unacceptable Waste (as determined by Republic) Customer agrees to assume all expenses and obligations with the removal and/or resolution of any effects caused by the delivery of such Unacceptable Waste.

Indemnización. Cliente acuerda indemnizar, mantener inmune, y defender Republic Services, Inc., sus subsidiarios, compañías, divisiones, empleados, oficiales y directores contra de cualquiera y de todas responsabilidades, demandas, penas, pérdidas, juicios, pleitos y los costos incidente además, incluyendo costos de defensa, de acuerdo judicial, y de honorarios razonables del abogado, que pueden ser incurridos en, o como resultado de, la muerte o herida personal a cualquier persona, o daños a cualquier característica, propiedad, contaminación de la tierra o efectos ilícitos en esta Facilidad, causado entero o en parte por el cliente, sus empleados, o sus subcontratistas en botar basura en esta Facilidad. En el caso que el Cliente entrega, bota, basura (según lo determinado por Republic) en este Establecimiento basura inaceptable en los reglamentos de este Establecimiento, el Cliente se compromete asumir todos los costos y obligaciones con el retiro y/o la resolución de cualquier dano(s) causado por la entrega de tal basura inaceptable.



NON-HAZARDOUS WASTE MANIFEST

MANIFEST # 12251

GENERATOR INFORMATION

Generator Name: Tronox LLC

Address: P.O. Box 55

City: Henderson County: Clark

State: NV Zip: 89009

Site Location (if different): 560 W. Lake Mead

Henderson, NV 89015 (702) 592-7727

CUSTOMER/BILLING INFORMATION

Billing Name: NGE LLC c/o Northgate Environment Management

Address: 300 Frank Ogawa Plaza, Ste 510

City: Oakland County: Alameda

State: CA Zip: 94612

Republic Services Approval #	Description of Waste	Volume/Weight	Expiration Date	Container Type
38251011244	Soil for disposal		12-31-2011	Tractor with Dump Trailer(s)
	RZ- _____ # _____	41.79		

*Attach Additional Sheet if necessary

I hereby certify that the above-described materials are non-hazardous wastes as defined by 40 CFR 261 or any applicable state law. Further, that the above named materials are properly classified, described, packaged, marked and labeled, and are in proper condition for transportation according to the applicable regulations of the Department of Transportation.

Susan Crowley (Name) [Signature] (Signature) Date Shipped

TRANSPORTER INFORMATION

Transporter Name: Las Vegas Paving

DOT # 191949

Address: 4420 S. Decatur

Truck Number: 145

Las Vegas, NV 89103

Phone Number: (702) 353-4355

I certify no hazardous waste or other regulated substance was knowingly introduced to the waste while in my custody. The waste transported in this vehicle is the waste identified above, to the best of my knowledge.

[Signature] (Signature) 10.8.10 (Date Delivered) Date Delivered

DISPOSAL SITE INFORMATION

Site Name: Apex Regional Landfill

Phone No. (702) 599-5920

Address: 13550 U.S. Hwy 93 Las Vegas, NV

I hereby acknowledge receipt of the above described materials [Signature] (Signature) 10.8.10 (Date Received) Date Received

81 Environmental Tech
13550 N Highway 93
Las Vegas, NV 89165

Ticket Type: INBOUND INVOICE

Ticket Number: 2174
Date: 10/08/2010
Time In: 3:29 pm
Time Out: 3:59 pm

Customer: 001011 - NGE, LLC c/o Northgate Environ Mgmt

Vehicle/Container: 58507P
Contract: Northgate Env. On Site Soils 3825 11
Comment: 3825-10-11244

Gross Weight: 130,280 LB Manual In
Tare Weight: 53,940 LB Manual Out
Net Weight: 76340 LB
Net Tons: 38.17

BOL: 12254

Origin	Yards	Material	Billing	Quantity
Not Applicable	0.00 YD	SW CONTAMINATED SOIL	38.17	TN

Driver: _____

Weighmaster: _____

IN - JORDADE OUT - GUILFDE

Indemnification. Customer agrees, by signature above, to indemnify, hold harmless, and defend Republic Services, Inc., its subsidiaries, affiliates, employees, officers and directors from and against any and all liabilities, claims, penalties, forfeitures, suits and the costs and expenses incident thereto, including costs of defense, settlement, and reasonable attorney's fees, which may be incurred, as a result of death or injuries to any person, or damage to any property, contamination of or adverse effects on the environment, caused in whole or in part by the Customer, its employees, or subcontractors in disposing waste at this Facility. In the event Customer delivers Unacceptable Waste (as determined by Republic) Customer agrees to assume all expenses and obligations with the removal and/or resolution of any effects caused by the delivery of such Unacceptable Waste.

Indemnización. Cliente acuerda indemnizar, mantener inmune, y defender Republic Services, Inc., sus subsidiarios, compañías, divisiones, empleados, oficiales y directores contra de cualquiera y de todas responsabilidades, demandas, penas, pérdidas, juicios, pleitos y los costos incidente además, incluyendo costos de defensa, de acuerdo judicial, y de honorarios razonables del abogado, que pueden ser incurridos en, o como resultado de, la muerte o herida personal a cualquier persona, o daños a cualquier característica, propiedad, contaminación de la tierra o efectos ilícitos en esta Facilidad, causado entero o en parte por el cliente, sus empleados, o sus subcontratistas en botar basura en esta Facilidad. En el caso que el Cliente entrega, bota, basura (según lo determinado por Republic) en este Establecimiento basura inaceptable en los reglamentos de este Establecimiento, el Cliente se compromete asumir todos los costos y obligaciones con el retiro y/o la resolución de cualquier dano(s) causado por la entrega de tal basura inaceptable.



NON-HAZARDOUS WASTE MANIFEST

MANIFEST # 12254

GENERATOR INFORMATION

Generator Name: Tronox LLC

Address: P.O. Box 55

City: Henderson County: Clark

State: NV Zip: 89009

Site Location (if different): 560 W. Lake Mead

Henderson, NV 89015 (702) 592-7727

CUSTOMER/BILLING INFORMATION

Billing Name: NGE LLC c/o Northgate Environment Management

Address: 300 Frank Ogawa Plaza, Ste 510

City: Oakland County: Alameda

State: CA Zip: 94612

Republic Services Approval #	Description of Waste	Volume/Weight	Expiration Date	Container Type
38251011244	Soil for disposal		12-31-2011	Tractor with Dump Trailer(s)
	RZ- _____ # _____	38.17		

*Attach Additional Sheet if necessary

I hereby certify that the above-described materials are non-hazardous wastes as defined by 40 CFR 261 or any applicable state law. Further, that the above named materials are properly classified, described, packaged, marked and labeled, and are in proper condition for transportation according to the applicable regulations of the Department of Transportation.

Susan Crowley
Generator/Authorized Agent Name

Susan Crowley
Signature

Date Shipped

TRANSPORTER INFORMATION

Transporter Name: Las Vegas Paving

DOT # 191949

Address: 4420 S. Decatur

Truck Number: 1020

Las Vegas, NV 89103

Phone Number: (702) 353-4355

I certify no hazardous waste or other regulated substance was knowingly introduced to the waste while in my custody. The waste transported in this vehicle is the waste identified above, to the best of my knowledge.

Name of Authorized Agent

[Signature]
Signature

10-8-10
Date Delivered

DISPOSAL SITE INFORMATION

Site Name: Apex Regional Landfill

Phone No. (702) 599-5920

Address: 13550 U.S. Hwy 93 Las Vegas, NV

I hereby acknowledge receipt of the above described materials

[Signature]
Name (Print or Type)

Signature

10-8-10
Date Received

81 Environmental Tech
13550 N Highway 93
Las Vegas, NV 89165

Ticket Type: INBOUND INVOICE

Ticket Number: 2175
Date: 10/08/2010
Time In: 3:36 pm
Time Out: 4:01 pm

Customer: 001011 - NGE, LLC c/o Northgate Environ Mgmt

Vehicle/Container: 29573A
Contract: Northgate Env. On Site Soils 3825 10
Comment: 3825-10-11244

Gross Weight: 123,920 LB Manual In
Tare Weight: 52,700 LB Manual Out
Net Weight: 71220 LB
Net Tons: 35.61

BOL: 12256

Origin	Yards	Material	Billing	Quantity
Not Applicable	0.00 YD	SW CONTAMINATED SOIL	35.61	TN

Driver: _____



Weighmaster: _____

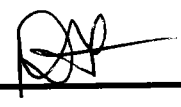

IN - JORDADE OUT - GUILFDE

Indemnification. Customer agrees, by signature above, to indemnify, hold harmless, and defend Republic Services, Inc., its subsidiaries, affiliates, employees, officers and directors from and against any and all liabilities, claims, penalties, forfeitures, suits and the costs and expenses incident thereto, including costs of defense, settlement, and reasonable attorney's fees, which may be incurred, as a result of death or injuries to any person, or damage to any property, contamination of or adverse effects on the environment, caused in whole or in part by the Customer, its employees, or subcontractors in disposing waste at this Facility. In the event Customer delivers Unacceptable Waste (as determined by Republic) Customer agrees to assume all expenses and obligations with the removal and/or resolution of any effects caused by the delivery of such Unacceptable Waste.

Indemnización. Cliente acuerda indemnizar, mantener inmune, y defender Republic Services, Inc., sus subsidiarios, compañías, divisiones, empleados, oficiales y directores contra de cualquiera y de todas responsabilidades, demandas, penas, pérdidas, juicios, pleitos y los costos incidente además, incluyendo costos de defensa, de acuerdo judicial, y de honorarios razonables del abogado, que pueden ser incurridos en, o como resultado de, la muerte o herida personal a cualquier persona, o daños a cualquier característica, propiedad, contaminación de la tierra o efectos ilícitos en esta Facilidad, causado entero o en parte por el cliente, sus empleados, o sus subcontratistas en botar basura en esta Facilidad. En el caso que el Cliente entrega, bota, basura (según lo determinado por Republic) en este Establecimiento basura inaceptable en los reglamentos de este Establecimiento, el Cliente se compromete asumir todos los costos y obligaciones con el retiro y/o la resolución de cualquier dano(s) causado por la entrega de tal basura inaceptable.

81 Environmental Tech
13550 N Highway 93
Las Vegas, NV 89165

Ticket Type: INBOUND INVOICE

Ticket Number: 2176
Date: 10/08/2010
Time In: 3:38 pm
Time Out: 4:02 pm

Customer: 001011 - NGE, LLC c/o Northgate Environ Mgmt

Vehicle/Container: 86680P
Contract: Northgate Env. On Site Soils 3825 11
Comment: 3825-10-11244

Gross Weight: 124,000 LB Manual In
Tare Weight: 54,340 LB Manual Out
Net Weight: 69660 LB
Net Tons: 34.83

BOL: 12255

Origin	Yards	Material	Billing	Quantity
Not Applicable	0.00 YD	SW CONTAMINATED SOIL	34.83	TN

Driver: _____

Weighmaster: _____

IN - JORDADE OUT - GUILFDE

Indemnification. Customer agrees, by signature above, to indemnify, hold harmless, and defend Republic Services, Inc., its subsidiaries, affiliates, employees, officers and directors from and against any and all liabilities, claims, penalties, forfeitures, suits and the costs and expenses incident thereto, including costs of defense, settlement, and reasonable attorney's fees, which may be incurred, as a result of death or injuries to any person, or damage to any property, contamination of or adverse effects on the environment, caused in whole or in part by the Customer, its employees, or subcontractors in disposing waste at this Facility. In the event Customer delivers Unacceptable Waste (as determined by Republic) Customer agrees to assume all expenses and obligations with the removal and/or resolution of any effects caused by the delivery of such Unacceptable Waste.

Indemnización. Cliente acuerda indemnizar, mantener inmune, y defender Republic Services, Inc., sus subsidiarios, compañías, divisiones, empleados, oficiales y directores contra de cualquiera y de todas responsabilidades, demandas, penas, pérdidas, juicios, pleitos y los costos incidente además, incluyendo costos de defensa, de acuerdo judicial, y de honorarios razonables del abogado, que pueden ser incurridos en, o como resultado de, la muerte o herida personal a cualquier persona, o daños a cualquier característica, propiedad, contaminación de la tierra o efectos ilícitos en esta Facilidad, causado entero o en parte por el cliente, sus empleados, o sus subcontratistas en botar basura en esta Facilidad. En el caso que el Cliente entrega, bota, basura (según lo determinado por Republic) en este Establecimiento basura inaceptable en los reglamentos de este Establecimiento, el Cliente se compromete asumir todos los costos y obligaciones con el retiro y/o la resolución de cualquier dano(s) causado por la entrega de tal basura inaceptable.



NON-HAZARDOUS WASTE MANIFEST

MANIFEST # 12255

GENERATOR INFORMATION

Generator Name: Tronox LLC

Address: P.O. Box 55

City: Henderson County: Clark

State: NV Zip: 89009

Site Location (if different): 560 W. Lake Mead
Henderson, NV 89015 (702) 592-7727

CUSTOMER/BILLING INFORMATION

Billing Name: NGE LLC c/o Northgate Environment Management

Address: 300 Frank Ogawa Plaza, Ste 510

City: Oakland County: Alameda

State: CA Zip: 94612

Table with 5 columns: Republic Services Approval #, Description of Waste, Volume/Weight, Expiration Date, Container Type. Row 1: 38251011244, Soil for disposal, 34.83, 12-31-2011, Tractor with Dump Trailer(s).

*Attach Additional Sheet if necessary

I hereby certify that the above-described materials are non-hazardous wastes as defined by 40 CFR 261 or any applicable state law. Further, that the above named materials are properly classified, described, packaged, marked and labeled, and are in proper condition for transportation according to the applicable regulations of the Department of Transportation.

Susan Crowley (Signature)
Generator/Authorized Agent Name Signature Date Shipped

TRANSPORTER INFORMATION

Transporter Name: Las Vegas Paving

DOT # 191949

Address: 4420 S. Decatur

Truck Number:

Las Vegas, NV 89103

Phone Number: (702) 353-4355

I certify no hazardous waste or other regulated substance was knowingly introduced to the waste while in my custody. The waste transported in this vehicle is the waste identified above, to the best of my knowledge.

(Signature)
Name of Authorized Agent Signature Date Delivered 10-8-10

DISPOSAL SITE INFORMATION

Site Name: Apex Regional Landfill

Phone No. (702) 599-5920

Address: 13550 U.S. Hwy 93 Las Vegas, NV

I hereby acknowledge receipt of the above described materials (Signature)
Name (Print or Type) Signature Date Received 10-8-10

81 Environmental Tech
13550 N Highway 93
Las Vegas, NV 89165

Ticket Type: INBOUND INVOICE

Ticket Number: 2177
Date: 10/08/2010
Time In: 3:45 pm
Time Out: 4:15 pm

Customer: 001011 - NGE, LLC c/o Northgate Environ Mgmt

Vehicle/Container: 86680P
Contract: Northgate Env. On Site Soils 3825 11
Comment: 3825-10-11244

Gross Weight: 121,640 LB Manual In
Tare Weight: 49,300 LB Manual Out
Net Weight: 72340 LB
Net Tons: 36.17

BOL: 12257

Origin	Yards	Material	Billing	Quantity
Not Applicable	0.00 YD	SW CONTAMINATED SOIL	36.17	TN

Driver: _____



Weighmaster: _____



IN - JORDADE OUT - GUILFDE

Indemnification. Customer agrees, by signature above, to indemnify, hold harmless, and defend Republic Services, Inc., its subsidiaries, affiliates, employees, officers and directors from and against any and all liabilities, claims, penalties, forfeitures, suits and the costs and expenses incident thereto, including costs of defense, settlement, and reasonable attorney's fees, which may be incurred, as a result of death or injuries to any person, or damage to any property, contamination of or adverse effects on the environment, caused in whole or in part by the Customer, its employees, or subcontractors in disposing waste at this Facility. In the event Customer delivers Unacceptable Waste (as determined by Republic) Customer agrees to assume all expenses and obligations with the removal and/or resolution of any effects caused by the delivery of such Unacceptable Waste.

Indemnización. Cliente acuerda indemnizar, mantener inmune, y defender Republic Services, Inc., sus subsidiarios, compañías, divisiones, empleados, oficiales y directores contra de cualquiera y de todas responsabilidades, demandas, penas, pérdidas, juicios, pleitos y los costos incidente además, incluyendo costos de defensa, de acuerdo judicial, y de honorarios razonables del abogado, que pueden ser incurridos en, o como resultado de, la muerte o herida personal a cualquier persona, o daños a cualquier característica, propiedad, contaminación de la tierra o efectos ilícitos en esta Facilidad, causado entero o en parte por el cliente, sus empleados, o sus subcontratistas en botar basura en esta Facilidad. En el caso que el Cliente entrega, bota, basura (según lo determinado por Republic) en este Establecimiento basura inaceptable en los reglamentos de este Establecimiento, el Cliente se compromete asumir todos los costos y obligaciones con el retiro y/o la resolución de cualquier dano(s) causado por la entrega de tal basura inaceptable.



NON-HAZARDOUS WASTE MANIFEST

MANIFEST # 12257

GENERATOR INFORMATION

Generator Name: Tronox LLC
Address: P.O. Box 55
City: Henderson County: Clark
State: NV Zip: 89009
Site Location (if different): 560 W. Lake Mead
Henderson, NV 89015 (702) 592-7727

CUSTOMER/BILLING INFORMATION

Billing Name: NGE LLC c/o Northgate Environment Management
Address: 300 Frank Ogawa Plaza, Ste 510
City: Oakland County: Alameda
State: CA Zip: 94612

Table with 5 columns: Republic Services Approval #, Description of Waste, Volume/Weight, Expiration Date, Container Type. Row 1: 38251011244, Soil for disposal, 36.17, 12-31-2011, Tractor with Dump Trailer(s).

*Attach Additional Sheet if necessary

I hereby certify that the above-described materials are non-hazardous wastes as defined by 40 CFR 261 or any applicable state law. Further, that the above named materials are properly classified, described, packaged, marked and labeled, and are in proper condition for transportation according to the applicable regulations of the Department of Transportation.

Susan Crowley (Signature)
Generator/Authorized Agent Name Signature Date Shipped

TRANSPORTER INFORMATION

Transporter Name: Las Vegas Paving DOT # 191949
Address: 4420 S. Decatur Truck Number: 110
Las Vegas, NV 89103 Phone Number: (702) 353-4355

I certify no hazardous waste or other regulated substance was knowingly introduced to the waste while in my custody. The waste transported in this vehicle is the waste identified above, to the best of my knowledge.

(Signature)
Name of Authorized Agent Signature Date Delivered 10-8-10

DISPOSAL SITE INFORMATION

Site Name: Apex Regional Landfill Phone No. (702) 599-5920
Address: 13550 U.S. Hwy 93 Las Vegas, NV

I hereby acknowledge receipt of the above described materials.
Name (Print or Type) Signature Date Received 10-8-10

81 Environmental Tech
13550 N Highway 93
Las Vegas, NV 89165

Ticket Type: INBOUND INVOICE

Ticket Number: 2178
Date: 10/08/2010
Time In: 4:01 pm
Time Out: 4:25 pm

Customer: 001011 - NGE, LLC c/o Northgate Environ Mgmt

Vehicle/Container: Z009877
Contract: Northgate Env. On Site Soils 3825 11
Comment: 3825-10-11244

Gross Weight: 118,720 LB Manual In
Tare Weight: 48,520 LB Manual Out
Net Weight: 70200 LB
Net Tons: 35.10

BOL: 12258

Origin	Yards	Material	Billing	Quantity
Not Applicable	0.00 YD	SW CONTAMINATED SOIL	35.10	TN

Driver: 

Weighmaster: 

IN - JORDADE OUT - GUILFDE

Indemnification. Customer agrees, by signature above, to indemnify, hold harmless, and defend Republic Services, Inc., its subsidiaries, affiliates, employees, officers and directors from and against any and all liabilities, claims, penalties, forfeitures, suits and the costs and expenses incident thereto, including costs of defense, settlement, and reasonable attorney's fees, which may be incurred, as a result of death or injuries to any person, or damage to any property, contamination of or adverse effects on the environment, caused in whole or in part by the Customer, its employees, or subcontractors in disposing waste at this Facility. In the event Customer delivers Unacceptable Waste (as determined by Republic) Customer agrees to assume all expenses and obligations with the removal and/or resolution of any effects caused by the delivery of such Unacceptable Waste.

Indemnización. Cliente acuerda indemnizar, mantener inmune, y defender Republic Services, Inc., sus subsidiarios, compañías, divisiones, empleados, oficiales y directores contra de cualquiera y de todas responsabilidades, demandas, penas, pérdidas, juicios, pleitos y los costos incidente además, incluyendo costos de defensa, de acuerdo judicial, y de honorarios razonables del abogado, que pueden ser incurridos en, o como resultado de, la muerte o herida personal a cualquier persona, o daños a cualquier característica, propiedad, contaminación de la tierra o efectos ilícitos en esta Facilidad, causado entero o en parte por el cliente, sus empleados, o sus subcontratistas en botar basura en esta Facilidad. En el caso que el Cliente entrega, bota, basura (según lo determinado por Republic) en este Establecimiento basura inaceptable en los reglamentos de este Establecimiento, el Cliente se compromete asumir todos los costos y obligaciones con el retiro y/o la resolución de cualquier dano(s) causado por la entrega de tal basura inaceptable.



NON-HAZARDOUS WASTE MANIFEST

MANIFEST # 12258

GENERATOR INFORMATION

Generator Name: Tronox LLC

Address: P.O. Box 55

City: Henderson County: Clark

State: NV Zip: 89009

Site Location (if different): 560 W. Lake Mead
Henderson, NV 89015 (702) 592-7727

CUSTOMER/BILLING INFORMATION

Billing Name: NGE LLC c/o Northgate Environment Management

Address: 300 Frank Ogawa Plaza, Ste 510

City: Oakland County: Alameda

State: CA Zip: 94612

Table with 5 columns: Republic Services Approval #, Description of Waste, Volume/Weight, Expiration Date, Container Type. Row 1: 38251011244, Soil for disposal, 35.10, 12-31-2011, Tractor with Dump Trailer(s).

*Attach Additional Sheet if necessary

I hereby certify that the above-described materials are non-hazardous wastes as defined by 40 CFR 261 or any applicable state law. Further, that the above named materials are properly classified, described, packaged, marked and labeled, and are in proper condition for transportation according to the applicable regulations of the Department of Transportation.

Susan Crowley (Signature)
Generator/Authorized Agent Name Signature Date Shipped

TRANSPORTER INFORMATION

Transporter Name: Las Vegas Paving

DOT # 191949

Address: 4420 S. Decatur

Truck Number: 2010

Las Vegas, NV 89103

Phone Number: (702) 353-4355

I certify no hazardous waste or other regulated substance was knowingly introduced to the waste while in my custody. The waste transported in this vehicle is the waste identified above, to the best of my knowledge.

(Signature)
Name of Authorized Agent Signature Date Delivered 10-8-10

DISPOSAL SITE INFORMATION

Site Name: Apex Regional Landfill

Phone No. (702) 599-5920

Address: 13550 U.S. Hwy 93 Las Vegas, NV

I hereby acknowledge receipt of the above described materials
Name (Print or Type) Signature Date Received 10-8-10



NON-HAZARDOUS WASTE MANIFEST

MANIFEST # 12259

GENERATOR INFORMATION

Generator Name: Tronox LLC

Address: P.O. Box 55

City: Henderson County: Clark

State: NV Zip: 89009

Site Location (if different): 560 W. Lake Mead
Henderson, NV 89015 (702) 592-7727

CUSTOMER/BILLING INFORMATION

Billing Name: NGE LLC c/o Northgate Environment Management

Address: 300 Frank Ogawa Plaza, Ste 510

City: Oakland County: Alameda

State: CA Zip: 94612

Table with 5 columns: Republic Services Approval #, Description of Waste, Volume/Weight, Expiration Date, Container Type. Row 1: 38251011244, Soil for disposal, 32.77 TN, 12-31-2011, Tractor with Dump Trailer(s). Row 2: RZ- #

*Attach Additional Sheet if necessary

I hereby certify that the above-described materials are non-hazardous wastes as defined by 40 CFR 261 or any applicable state law. Further, that the above named materials are properly classified, described, packaged, marked and labeled, and are in proper condition for transportation according to the applicable regulations of the Department of Transportation.

Susan Crowley (Signature)
Generator/Authorized Agent Name Signature Date Shipped

TRANSPORTER INFORMATION

Transporter Name: Las Vegas Paving

DOT # 191949

Address: 4420 S. Decatur

Truck Number: RH301

Las Vegas, NV 89103

Phone Number: (702) 353-4355

I certify no hazardous waste or other regulated substance was knowingly introduced to the waste while in my custody. The waste transported in this vehicle is the waste identified above, to the best of my knowledge.

J J (Signature) 10-8-10
Name of Authorized Agent Signature Date Delivered

DISPOSAL SITE INFORMATION

Site Name: Apex Regional Landfill

Phone No. (702) 599-5920

Address: 13550 U.S. Hwy 93 Las Vegas, NV

I hereby acknowledge receipt of the above described materials

JASON CARTER (Signature) 10/8/10
Name (Print or Type) Signature Date Received

81 Environmental Tech
13550 N Highway 93
Las Vegas, NV 89165

Ticket Type: INBOUND INVOICE

Ticket Number: 2180
Date: 10/08/2010
Time In: 4:23 pm
Time Out: 4:50 pm

Customer: 001011 - NGE, LLC c/o Northgate Environ Mgmt

Vehicle/Container: 44164A
Contract: Northgate Env. On Site Soils 3825 11
Comment: 3825 10 11244

Gross Weight: 126,140 LB Manual In
Tare Weight: 56,120 LB Manual Out
Net Weight: 70020 LB
Net Tons: 35.01

BOL: 12260

Origin	Yards	Material	Billing	Quantity
Not Applicable	0.00 YD	SW CONTAMINATED SOIL	35.01	TN

Driver: _____

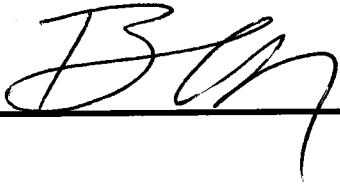

Weighmaster: _____

IN - JORDADE OUT - CARTERJ

Indemnification. Customer agrees, by signature above, to indemnify, hold harmless, and defend Republic Services, Inc., its subsidiaries, affiliates, employees, officers and directors from and against any and all liabilities, claims, penalties, forfeitures, suits and the costs and expenses incident thereto, including costs of defense, settlement, and reasonable attorney's fees, which may be incurred, as a result of death or injuries to any person, or damage to any property, contamination of or adverse effects on the environment, caused in whole or in part by the Customer, its employees, or subcontractors in disposing waste at this Facility. In the event Customer delivers Unacceptable Waste (as determined by Republic) Customer agrees to assume all expenses and obligations with the removal and/or resolution of any effects caused by the delivery of such Unacceptable Waste.

Indemnización. Cliente acuerda indemnizar, mantener inmune, y defender Republic Services, Inc., sus subsidiarios, compañías, divisiones, empleados, oficiales y directores contra de cualquiera y de todas responsabilidades, demandas, penas, pérdidas, juicios, pleitos y los costos incidente además, incluyendo costos de defensa, de acuerdo judicial, y de honorarios razonables del abogado, que pueden ser incurridos en, o como resultado de, la muerte o herida personal a cualquier persona, o daños a cualquier característica, propiedad, contaminación de la tierra o efectos ilícitos en esta Facilidad, causado entero o en parte por el cliente, sus empleados, o sus subcontratistas en botar basura en esta Facilidad. En el caso que el Cliente entrega, bota, basura (según lo determinado por Republic) en este Establecimiento basura inaceptable en los reglamentos de este Establecimiento, el Cliente se compromete asumir todos los costos y obligaciones con el retiro y/o la resolución de cualquier dano(s) causado por la entrega de tal basura inaceptable.



NON-HAZARDOUS WASTE MANIFEST

MANIFEST # 12260

GENERATOR INFORMATION

Generator Name: Tronox LLC

Address: P.O. Box 55

City: Henderson County: Clark

State: NV Zip: 89009

Site Location (if different): 560 W. Lake Mead
Henderson, NV 89015 (702) 592-7727

CUSTOMER/BILLING INFORMATION

Billing Name: NGE LLC c/o Northgate Environment Management

Address: 300 Frank Ogawa Plaza, Ste 510

City: Oakland County: Alameda

State: CA Zip: 94612

Table with 5 columns: Republic Services Approval #, Description of Waste, Volume/Weight, Expiration Date, Container Type. Row 1: 38251011244, Soil for disposal, 35.01 TN, 12-31-2011, Tractor with Dump Trailer(s). Row 2: RZ- #

*Attach Additional Sheet if necessary

I hereby certify that the above-described materials are non-hazardous wastes as defined by 40 CFR 261 or any applicable state law. Further, that the above named materials are properly classified, described, packaged, marked and labeled, and are in proper condition for transportation according to the applicable regulations of the Department of Transportation.

Susan Crowley
Generator/Authorized Agent Name Signature Date Shipped

TRANSPORTER INFORMATION

Transporter Name: Las Vegas Paving

DOT # 191949

Address: 4420 S. Decatur

Truck Number: K-006

Las Vegas, NV 89103

Phone Number: (702) 353-4355

I certify no hazardous waste or other regulated substance was knowingly introduced to the waste while in my custody. The waste transported in this vehicle is the waste identified above, to the best of my knowledge.

Brian Mulvey
Name of Authorized Agent Signature Date Delivered 10.8.10

DISPOSAL SITE INFORMATION

Site Name: Apex Regional Landfill

Phone No. (702) 599-5920

Address: 13550 U.S. Hwy 93 Las Vegas, NV

I hereby acknowledge receipt of the above described materials
JASON CARTER
Name (Print or Type) Signature Date Received 10/8/10

81 Environmental Tech
13550 N Highway 93
Las Vegas, NV 89165

Ticket Type: INBOUND INVOICE

Ticket Number: 2181
Date: 10/08/2019
Time In: 4:25 pm
Time Out: 4:53 pm

Customer: 001011 - NGE, LLC c/o Northgate Environ Mgmt

Vehicle/Container: 71893P

Contract: Northgate Env. On Site Soils 3825 11

Comment: 3825 10 11244

Gross Weight: 128,200 LB Manual In
Tare Weight: 53,040 LB Manual Out
Net Weight: 75,160 LB
Net Tons: 37.58

BOL: 12261

Origin	Yards	Material	Billing Quantity
Not Applicable	0.00 YD	SW CONTAMINATED SOIL	37.58 TN

Driver: _____

Weighmaster: _____

IN - JORDADE OUT - CARTERJ

Indemnification. Customer agrees, by signature above, to indemnify, hold harmless, and defend Republic Services, Inc., its subsidiaries, affiliates, employees, officers and directors from and against any and all liabilities, claims, penalties, forfeitures, suits and the costs and expenses incident thereto, including costs of defense, settlement, and reasonable attorney's fees, which may be incurred, as a result of death or injuries to any person, or damage to any property, contamination of or adverse effects on the environment, caused in whole or in part by the Customer, its employees, or subcontractors in disposing waste at this Facility. In the event Customer delivers Unacceptable Waste (as determined by Republic) Customer agrees to assume all expenses and obligations with the removal and/or resolution of any effects caused by the delivery of such Unacceptable Waste.

Indemnización. Cliente acuerda indemnizar, mantener inmune, y defender Republic Services, Inc., sus subsidiarios, compañías, divisiones, empleados, oficiales y directores contra de cualquiera y de todas responsabilidades, demandas, penas, pérdidas, juicios, pleitos y los costos incidente además, incluyendo costos de defensa, de acuerdo judicial, y de honorarios razonables del abogado, que pueden ser incurridos en, o como resultado de, la muerte o herida personal a cualquier persona, o daños a cualquier característica, propiedad, contaminación de la tierra o efectos ilícitos en esta Facilidad, causado entero o en parte por el cliente, sus empleados, o sus subcontratistas en botar basura en esta Facilidad. En el caso que el Cliente entrega, bota, basura (según lo determinado por Republic) en este Establecimiento basura inaceptable en los reglamentos de este Establecimiento, el Cliente se compromete asumir todos los costos y obligaciones con el retiro y/o la resolución de cualquier dano(s) causado por la entrega de tal basura inaceptable.



NON-HAZARDOUS WASTE MANIFEST

MANIFEST # 12261

GENERATOR INFORMATION

Generator Name: Tronox LLC

Address: P.O. Box 55

City: Henderson County: Clark

State: NV Zip: 89009

Site Location (if different): 560 W. Lake Mead

Henderson, NV 89015 (702) 592-7727

CUSTOMER/BILLING INFORMATION

Billing Name: NGE LLC c/o Northgate Environment Management

Address: 300 Frank Ogawa Plaza, Ste 510

City: Oakland County: Alameda

State: CA Zip: 94612

Republic Services Approval #	Description of Waste	Volume/Weight	Expiration Date	Container Type
38251011244	Soil for disposal	37.58 TN	12-31-2011	Tractor with Dump Trailer(s)
	RZ- _____ # _____			

*Attach Additional Sheet if necessary

I hereby certify that the above-described materials are non-hazardous wastes as defined by 40 CFR 261 or any applicable state law. Further, that the above named materials are properly classified, described, packaged, marked and labeled, and are in proper condition for transportation according to the applicable regulations of the Department of Transportation.

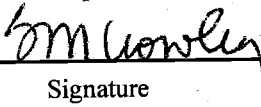
Susan Crowley  _____
 Generator/Authorized Agent Name Signature Date Shipped

TRANSPORTER INFORMATION

Transporter Name: Las Vegas Paving

DOT # 191949

Address: 4420 S. Decatur

Truck Number: JH7

Las Vegas, NV 89103

Phone Number: (702) 353-4355

I certify no hazardous waste or other regulated substance was knowingly introduced to the waste while in my custody. The waste transported in this vehicle is the waste identified above, to the best of my knowledge.

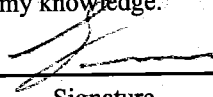
_____  _____
 Name of Authorized Agent Signature Date Delivered: 10-8-10

DISPOSAL SITE INFORMATION

Site Name: Apex Regional Landfill

Phone No. (702) 599-5920

Address: 13550 U.S. Hwy 93 Las Vegas, NV

I hereby acknowledge receipt of the above described materials

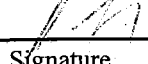
JASON CARTER  _____
 Name (Print or Type) Signature Date Received: 10/8/10

81 Environmental Tech
13550 N Highway 93
Las Vegas, NV 89165

Ticket Type: INBOUND INVOICE

Ticket Number: 2182
Date: 10/08/2010
Time In: 4:34 pm
Time Out: 4:57 pm

Customer: 001011 - NGE, LLC c/o Northgate Environ Mgmt

Vehicle/Container: 85156P
Contract: Northgate Env. On Site Soils 3825 11
Comment: 3825 10 11244

Gross Weight: 133,820 LB Manual In
Tare Weight: 56,700 LB Manual Out
Net Weight: 77120 LB
Net Tons: 38.56

BOL: 12263

Origin	Yards	Material	Billing Quantity
Not Applicable	0.00 YD	SW CONTAMINATED SOIL	38.56 TN

Driver: 

Weighmaster: 

CARTERJ

Indemnification. Customer agrees, by signature above, to indemnify, hold harmless, and defend Republic Services, Inc., its subsidiaries, affiliates, employees, officers and directors from and against any and all liabilities, claims, penalties, forfeitures, suits and the costs and expenses incident thereto, including costs of defense, settlement, and reasonable attorney's fees, which may be incurred, as a result of death or injuries to any person, or damage to any property, contamination of or adverse effects on the environment, caused in whole or in part by the Customer, its employees, or subcontractors in disposing waste at this Facility. In the event Customer delivers Unacceptable Waste (as determined by Republic) Customer agrees to assume all expenses and obligations with the removal and/or resolution of any effects caused by the delivery of such Unacceptable Waste.

Indemnización. Cliente acuerda indemnizar, mantener inmune, y defender Republic Services, Inc., sus subsidiarios, compañías, divisiones, empleados, oficiales y directores contra de cualquiera y de todas responsabilidades, demandas, penas, pérdidas, juicios, pleitos y los costos incidente además, incluyendo costos de defensa, de acuerdo judicial, y de honorarios razonables del abogado, que pueden ser incurridos en, o como resultado de, la muerte o herida personal a cualquier persona, o daños a cualquier característica, propiedad, contaminación de la tierra o efectos ilícitos en esta Facilidad, causado entero o en parte por el cliente, sus empleados, o sus subcontratistas en botar basura en esta Facilidad. En el caso que el Cliente entrega, bota, basura (según lo determinado por Republic) en este Establecimiento basura inaceptable en los reglamentos de este Establecimiento, el Cliente se compromete asumir todos los costos y obligaciones con el retiro y/o la resolución de cualquier dano(s) causado por la entrega de tal basura inaceptable.



NON-HAZARDOUS WASTE MANIFEST

MANIFEST # 12263

GENERATOR INFORMATION

Generator Name: Tronox LLC
Address: P.O. Box 55
City: Henderson County: Clark
State: NV Zip: 89009
Site Location (if different): 560 W. Lake Mead
Henderson, NV 89015 (702) 592-7727

CUSTOMER/BILLING INFORMATION

Billing Name: NGE LLC c/o Northgate Environment Management
Address: 300 Frank Ogawa Plaza, Ste 510
City: Oakland County: Alameda
State: CA Zip: 94612

Table with 5 columns: Republic Services Approval #, Description of Waste, Volume/Weight, Expiration Date, Container Type. Row 1: 38251011244, Soil for disposal, 38.56 TN, 12-31-2011, Tractor with Dump Trailer(s).

*Attach Additional Sheet if necessary

I hereby certify that the above-described materials are non-hazardous wastes as defined by 40 CFR 261 or any applicable state law. Further, that the above named materials are properly classified, described, packaged, marked and labeled, and are in proper condition for transportation according to the applicable regulations of the Department of Transportation.

Susan Crowley (Signature)
Generator/Authorized Agent Name Signature Date Shipped

TRANSPORTER INFORMATION

Transporter Name: Las Vegas Paving DOT # 191949
Address: 4420 S. Decatur Truck Number: 44
Las Vegas, NV 89103 Phone Number: (702) 353-4355

I certify no hazardous waste or other regulated substance was knowingly introduced to the waste while in my custody. The waste transported in this vehicle is the waste identified above, to the best of my knowledge.

Da H (Signature) 10.8.10
Name of Authorized Agent Signature Date Delivered

DISPOSAL SITE INFORMATION

Site Name: Apex Regional Landfill Phone No. (702) 599-5920
Address: 13550 U.S. Hwy 93 Las Vegas, NV

I hereby acknowledge receipt of the above described materials
JASON CARTER (Signature) 10/8/10
Name (Print or Type) Signature Date Received

81 Environmental Tech
13550 N Highway 93
Las Vegas, NV 89165

Ticket Type: INBOUND INVOICE

Ticket Number: 2183
Date: 10/08/2010
Time In: 4:38 pm
Time Out: 5:04 pm

Customer: 001011 - NGE, LLC c/o Northgate Environ Mgmt

Vehicle/Container: 85914P
Contract: Northgate Env. On Site Soils 3825 10
Comment: 3825 10 11244

Gross Weight: 125,760 LB Manual In
Tare Weight: 53,360 LB Manual Out
Net Weight: 72400 LB
Net Tons: 36.20

BOL: 12262

Origin	Yards	Material	Billing Quantity
Not Applicable	0.00 YD	SW CONTAMINATED SOIL	36.20 TN

Driver:



Weighmaster:

CARTERJ

Indemnification. Customer agrees, by signature above, to indemnify, hold harmless, and defend Republic Services, Inc., its subsidiaries, affiliates, employees, officers and directors from and against any and all liabilities, claims, penalties, forfeitures, suits and the costs and expenses incident thereto, including costs of defense, settlement, and reasonable attorney's fees, which may be incurred, as a result of death or injuries to any person, or damage to any property, contamination of or adverse effects on the environment, caused in whole or in part by the Customer, its employees, or subcontractors in disposing waste at this Facility. In the event Customer delivers Unacceptable Waste (as determined by Republic) Customer agrees to assume all expenses and obligations with the removal and/or resolution of any effects caused by the delivery of such Unacceptable Waste.

Indemnización. Cliente acuerda indemnizar, mantener inmune, y defender Republic Services, Inc., sus subsidiarios, compañías, divisiones, empleados, oficiales y directores contra de cualquiera y de todas responsabilidades, demandas, penas, pérdidas, juicios, pleitos y los costos incidente además, incluyendo costos de defensa, de acuerdo judicial, y de honorarios razonables del abogado, que pueden ser incurridos en, o como resultado de, la muerte o herida personal a cualquier persona, o daños a cualquier característica, propiedad, contaminación de la tierra o efectos ilícitos en esta Facilidad, causado entero o en parte por el cliente, sus empleados, o sus subcontratistas en botar basura en esta Facilidad. En el caso que el Cliente entrega, bota, basura (según lo determinado por Republic) en este Establecimiento basura inaceptable en los reglamentos de este Establecimiento, el Cliente se compromete asumir todos los costos y obligaciones con el retiro y/o la resolución de cualquier dano(s) causado por la entrega de tal basura inaceptable.



NON-HAZARDOUS WASTE MANIFEST

MANIFEST # 12262

GENERATOR INFORMATION

Generator Name: Tronox LLC
Address: P.O. Box 55
City: Henderson County: Clark
State: NV Zip: 89009
Site Location (if different): 560 W. Lake Mead
Henderson, NV 89015 (702) 592-7727

CUSTOMER/BILLING INFORMATION

Billing Name: NGE LLC c/o Northgate Environment Management
Address: 300 Frank Ogawa Plaza, Ste 510
City: Oakland County: Alameda
State: CA Zip: 94612

Table with 5 columns: Republic Services Approval #, Description of Waste, Volume/Weight, Expiration Date, Container Type. Row 1: 38251011244, Soil for disposal, 36.20 TN, 12-31-2011, Tractor with Dump Trailer(s).

*Attach Additional Sheet if necessary

I hereby certify that the above-described materials are non-hazardous wastes as defined by 40 CFR 261 or any applicable state law. Further, that the above named materials are properly classified, described, packaged, marked and labeled, and are in proper condition for transportation according to the applicable regulations of the Department of Transportation.

Susan Crowley (Signature)
Generator/Authorized Agent Name Signature Date Shipped

TRANSPORTER INFORMATION

Transporter Name: Las Vegas Paving DOT # 191949
Address: 4420 S. Decatur Truck Number: DE 07
Las Vegas, NV 89103 Phone Number: (702) 353-4355

I certify no hazardous waste or other regulated substance was knowingly introduced to the waste while in my custody. The waste transported in this vehicle is the waste identified above, to the best of my knowledge.

DAVID DELCID (Signature)
Name of Authorized Agent Signature Date Delivered 10-8-10

DISPOSAL SITE INFORMATION

Site Name: Apex Regional Landfill Phone No. (702) 599-5920
Address: 13550 U.S. Hwy 93 Las Vegas, NV

I hereby acknowledge receipt of the above described materials
JASON CARTEC (Signature)
Name (Print or Type) Signature Date Received 10/8/10

81 Environmental Tech
13550 N Highway 93
Las Vegas, NV 89165

Ticket Type: INBOUND INVOICE

Ticket Number: 2184
Date: 10/08/2010
Time In: 4:45 pm
Time Out: 5:07 pm

Customer: 001011 - NGE, LLC c/o Northgate Environ Mgmt

Vehicle/Container: 85887P
Contract: Northgate Env. On Site Soils 3825 11
Comment: 3825 10 11244

Gross Weight: 117,600 LB Manual In
Tare Weight: 50,320 LB Manual Out
Net Weight: 67280 LB
Net Tons: 33.64

BOL: 12264

Origin	Yards	Material	Billing Quantity
Not Applicable	0.00 YD	SW CONTAMINATED SOIL	33.64 TN

Driver: Miguel Ramos

Weighmaster: CARTERJ

Indemnification. Customer agrees, by signature above, to indemnify, hold harmless, and defend Republic Services, Inc., its subsidiaries, affiliates, employees, officers and directors from and against any and all liabilities, claims, penalties, forfeitures, suits and the costs and expenses incident thereto, including costs of defense, settlement, and reasonable attorney's fees, which may be incurred, as a result of death or injuries to any person, or damage to any property, contamination of or adverse effects on the environment, caused in whole or in part by the Customer, its employees, or subcontractors in disposing waste at this Facility. In the event Customer delivers Unacceptable Waste (as determined by Republic) Customer agrees to assume all expenses and obligations with the removal and/or resolution of any effects caused by the delivery of such Unacceptable Waste.

Indemnización. Cliente acuerda indemnizar, mantener inmune, y defender Republic Services, Inc., sus subsidiarios, compañías, divisiones, empleados, oficiales y directores contra de cualquiera y de todas responsabilidades, demandas, penas, pérdidas, juicios, pleitos y los costos incidente además, incluyendo costos de defensa, de acuerdo judicial, y de honorarios razonables del abogado, que pueden ser incurridos en, o como resultado de, la muerte o herida personal a cualquier persona, o daños a cualquier característica, propiedad, contaminación de la tierra o efectos ilícitos en esta Facilidad, causado entero o en parte por el cliente, sus empleados, o sus subcontratistas en botar basura en esta Facilidad. En el caso que el Cliente entrega, bota, basura (según lo determinado por Republic) en este Establecimiento basura inaceptable en los reglamentos de este Establecimiento, el Cliente se compromete asumir todos los costos y obligaciones con el retiro y/o la resolución de cualquier dano(s) causado por la entrega de tal basura inaceptable.



NON-HAZARDOUS WASTE MANIFEST

MANIFEST # 12264

GENERATOR INFORMATION

Generator Name: Tronox LLC
Address: P.O. Box 55
City: Henderson County: Clark
State: NV Zip: 89009
Site Location (if different): 560 W. Lake Mead
Henderson, NV 89015 (702) 592-7727

CUSTOMER/BILLING INFORMATION

Billing Name: NGE LLC c/o Northgate Environment Management
Address: 300 Frank Ogawa Plaza, Ste 510
City: Oakland County: Alameda
State: CA Zip: 94612

Table with 5 columns: Republic Services Approval #, Description of Waste, Volume/Weight, Expiration Date, Container Type. Row 1: 38251011244, Soil for disposal, 33.64 TN, 12-31-2011, Tractor with Dump Trailer(s). Row 2: RZ- #

*Attach Additional Sheet if necessary

I hereby certify that the above-described materials are non-hazardous wastes as defined by 40 CFR 261 or any applicable state law. Further, that the above named materials are properly classified, described, packaged, marked and labeled, and are in proper condition for transportation according to the applicable regulations of the Department of Transportation.

Susan Crowley (Signature)
Generator/Authorized Agent Name Signature Date Shipped

TRANSPORTER INFORMATION

Transporter Name: Las Vegas Paving DOT # 191949
Address: 4420 S. Decatur Truck Number: 201
Las Vegas, NV 89103 Phone Number: (702) 353-4355

I certify no hazardous waste or other regulated substance was knowingly introduced to the waste while in my custody. The waste transported in this vehicle is the waste identified above, to the best of my knowledge.

(Signature) Ramos 10-8-10
Name of Authorized Agent Signature Date Delivered

DISPOSAL SITE INFORMATION

Site Name: Apex Regional Landfill Phone No. (702) 599-5920
Address: 13550 U.S. Hwy 93 Las Vegas, NV

I hereby acknowledge receipt of the above described materials
JASON CARTER (Signature) 10/8/10
Name (Print or Type) Signature Date Received

81 Environmental Tech
13550 N Highway 93
Las Vegas, NV 89165

Ticket Type: INBOUND INVOICE

Ticket Number: 2185
Date: 10/08/2010
Time In: 5:00 pm
Time Out: 5:25 pm

Customer: 001011 - NGE, LLC c/o Northgate Environ Mgmt

Vehicle/Container: 82515P
Contract: Northgate Env. On Site Soils 3825 11
Comment: 3825 10 11244

Gross Weight: 117,840 LB Manual In
Tare Weight: 53,200 LB Manual Out
Net Weight: 64640 LB
Net Tons: 32.32

BOL: 12265

Origin	Yards	Material	Billing Quantity
Not Applicable	0.00 YD	SW CONTAMINATED SOIL	32.32 TN

Driver: _____

S. Weid #144

Weighmaster: _____

CARTERJ

Indemnification. Customer agrees, by signature above, to indemnify, hold harmless, and defend Republic Services, Inc., its subsidiaries, affiliates, employees, officers and directors from and against any and all liabilities, claims, penalties, forfeitures, suits and the costs and expenses incident thereto, including costs of defense, settlement, and reasonable attorney's fees, which may be incurred, as a result of death or injuries to any person, or damage to any property, contamination of or adverse effects on the environment, caused in whole or in part by the Customer, its employees, or subcontractors in disposing waste at this Facility. In the event Customer delivers Unacceptable Waste (as determined by Republic) Customer agrees to assume all expenses and obligations with the removal and/or resolution of any effects caused by the delivery of such Unacceptable Waste.

Indemnización. Cliente acuerda indemnizar, mantener inmune, y defender Republic Services, Inc., sus subsidiarios, compañías, divisiones, empleados, oficiales y directores contra de cualquiera y de todas responsabilidades, demandas, penas, pérdidas, juicios, pleitos y los costos incidente además, incluyendo costos de defensa, de acuerdo judicial, y de honorarios razonables del abogado, que pueden ser incurridos en, o como resultado de, la muerte o herida personal a cualquier persona, o daños a cualquier característica, propiedad, contaminación de la tierra o efectos ilícitos en esta Facilidad, causado entero o en parte por el cliente, sus empleados, o sus subcontratistas en botar basura en esta Facilidad. En el caso que el Cliente entrega, bota, basura (según lo determinado por Republic) en este Establecimiento basura inaceptable en los reglamentos de este Establecimiento, el Cliente se compromete asumir todos los costos y obligaciones con el retiro y/o la resolución de cualquier dano(s) causado por la entrega de tal basura inaceptable.



NON-HAZARDOUS WASTE MANIFEST

MANIFEST # 12265

GENERATOR INFORMATION

Generator Name: Tronox LLC
Address: P.O. Box 55
City: Henderson County: Clark
State: NV Zip: 89009
Site Location (if different): 560 W. Lake Mead
Henderson, NV 89015 (702) 592-7727

CUSTOMER/BILLING INFORMATION

Billing Name: NGE LLC c/o Northgate Environment Management
Address: 300 Frank Ogawa Plaza, Ste 510
City: Oakland County: Alameda
State: CA Zip: 94612

Table with 5 columns: Republic Services Approval #, Description of Waste, Volume/Weight, Expiration Date, Container Type. Row 1: 38251011244, Soil for disposal, 32.32 TN, 12-31-2011, Tractor with Dump Trailer(s).

*Attach Additional Sheet if necessary

I hereby certify that the above-described materials are non-hazardous wastes as defined by 40 CFR 261 or any applicable state law. Further, that the above named materials are properly classified, described, packaged, marked and labeled, and are in proper condition for transportation according to the applicable regulations of the Department of Transportation.

Susan Crowley (Signature)
Generator/Authorized Agent Name Signature Date Shipped

TRANSPORTER INFORMATION

Transporter Name: Las Vegas Paving DOT # 191949
Address: 4420 S. Decatur Truck Number: 144
Las Vegas, NV 89103 Phone Number: (702) 353-4355

I certify no hazardous waste or other regulated substance was knowingly introduced to the waste while in my custody. The waste transported in this vehicle is the waste identified above, to the best of my knowledge.

St. Wood 144 (Signature)
Name of Authorized Agent Signature Date Delivered 10.8.10

DISPOSAL SITE INFORMATION

Site Name: Apex Regional Landfill Phone No. (702) 599-5920
Address: 13550 U.S. Hwy 93 Las Vegas, NV

I hereby acknowledge receipt of the above described materials
JASON CARTER (Signature)
Name (Print or Type) Signature Date Received 10/8/10

81 Environmental Tech
13550 N Highway 93
Las Vegas, NV 89165

Ticket Type: INBOUND INVOICE

Ticket Number: 2186
Date: 10/08/2010
Time In: 5:29 pm
Time Out: 5:29 pm

Customer: 001011 - NGE, LLC c/o Northgate Environ Mgmt

Vehicle/Container: 66954P
Contract: Northgate Env. On Site Soils 3825 11
Comment: 3825 10 11244

Gross Weight: 119,340 LB Manual In
Tare Weight: 53,040 LB Manual Out
Net Weight: 66300 LB
Net Tons: 33.15

BOL: 12266

Origin	Yards	Material	Billing Quantity
Not Applicable	0.00 YD	SW CONTAMINATED SOIL	33.15 TN

Driver: _____

Weighmaster: _____

CARTERJ

Indemnification. Customer agrees, by signature above, to indemnify, hold harmless, and defend Republic Services, Inc., its subsidiaries, affiliates, employees, officers and directors from and against any and all liabilities, claims, penalties, forfeitures, suits and the costs and expenses incident thereto, including costs of defense, settlement, and reasonable attorney's fees, which may be incurred, as a result of death or injuries to any person, or damage to any property, contamination of or adverse effects on the environment, caused in whole or in part by the Customer, its employees, or subcontractors in disposing waste at this Facility. In the event Customer delivers Unacceptable Waste (as determined by Republic) Customer agrees to assume all expenses and obligations with the removal and/or resolution of any effects caused by the delivery of such Unacceptable Waste.

Indemnización. Cliente acuerda indemnizar, mantener inmune, y defender Republic Services, Inc., sus subsidiarios, compañías, divisiones, empleados, oficiales y directores contra de cualquiera y de todas responsabilidades, demandas, penas, pérdidas, juicios, pleitos y los costos incidente además, incluyendo costos de defensa, de acuerdo judicial, y de honorarios razonables del abogado, que pueden ser incurridos en, o como resultado de, la muerte o herida personal a cualquier persona, o daños a cualquier característica, propiedad, contaminación de la tierra o efectos ilícitos en esta Facilidad, causado entero o en parte por el cliente, sus empleados, o sus subcontratistas en botar basura en esta Facilidad. En el caso que el Cliente entrega, bota, basura (según lo determinado por Republic) en este Establecimiento basura inaceptable en los reglamentos de este Establecimiento, el Cliente se compromete asumir todos los costos y obligaciones con el retiro y/o la resolución de cualquier dano(s) causado por la entrega de tal basura inaceptable.



NON-HAZARDOUS WASTE MANIFEST

MANIFEST # 12266

GENERATOR INFORMATION

Generator Name: Tronox LLC
Address: P.O. Box 55
City: Henderson County: Clark
State: NV Zip: 89009
Site Location (if different): 560 W. Lake Mead
Henderson, NV 89015 (702) 592-7727

CUSTOMER/BILLING INFORMATION

Billing Name: NGE LLC c/o Northgate Environment Management
Address: 300 Frank Ogawa Plaza, Ste 510
City: Oakland County: Alameda
State: CA Zip: 94612

Table with 5 columns: Republic Services Approval #, Description of Waste, Volume/Weight, Expiration Date, Container Type. Row 1: 38251011244, Soil for disposal, 33.15 TN, 12-31-2011, Tractor with Dump Trailer(s).

*Attach Additional Sheet if necessary

I hereby certify that the above-described materials are non-hazardous wastes as defined by 40 CFR 261 or any applicable state law. Further, that the above named materials are properly classified, described, packaged, marked and labeled, and are in proper condition for transportation according to the applicable regulations of the Department of Transportation.

Susan Crowley (Signature)
Generator/Authorized Agent Name Signature Date Shipped

TRANSPORTER INFORMATION

Transporter Name: Las Vegas Paving DOT # 191949
Address: 4420 S. Decatur Truck Number: M9G55
Las Vegas, NV 89103 Phone Number: (702) 353-4355

I certify no hazardous waste or other regulated substance was knowingly introduced to the waste while in my custody. The waste transported in this vehicle is the waste identified above, to the best of my knowledge.

(Signature) 10.8.10
Name of Authorized Agent Signature Date Delivered

DISPOSAL SITE INFORMATION

Site Name: Apex Regional Landfill Phone No. (702) 599-5920
Address: 13550 U.S. Hwy 93 Las Vegas, NV

I hereby acknowledge receipt of the above described materials

JASON CARTER (Signature) 10/8/10
Name (Print or Type) Signature Date Received

81 Environmental Tech
13550 N Highway 93
Las Vegas, NV 89165

Ticket Type: INBOUND INVOICE

Ticket Number: 2187
Date: 10/08/2010
Time In: 5:07 pm
Time Out: 5:58 pm

Customer: 001011 - NGE, LLC c/o Northgate Environ Mgmt

Vehicle/Container: 83951P
Contract: Northgate Env. On Site Soils 3825 11
Comment: 3825 10 11244

Gross Weight: 123,160 LB Manual In
Tare Weight: 54,720 LB Manual Out
Net Weight: 68440 LB
Net Tons: 34.22

BOL: 12267

Origin	Yards	Material	Billing	Quantity
Not Applicable	0.00 YD	SW CONTAMINATED SOIL	34.22	TN

Driver:

Cristino Medina

Weighmaster:

CARTERJ

Indemnification. Customer agrees, by signature above, to indemnify, hold harmless, and defend Republic Services, Inc., its subsidiaries, affiliates, employees, officers and directors from and against any and all liabilities, claims, penalties, forfeitures, suits and the costs and expenses incident thereto, including costs of defense, settlement, and reasonable attorney's fees, which may be incurred, as a result of death or injuries to any person, or damage to any property, contamination of or adverse effects on the environment, caused in whole or in part by the Customer, its employees, or subcontractors in disposing waste at this Facility. In the event Customer delivers Unacceptable Waste (as determined by Republic) Customer agrees to assume all expenses and obligations with the removal and/or resolution of any effects caused by the delivery of such Unacceptable Waste.

Indemnización. Cliente acuerda indemnizar, mantener inmune, y defender Republic Services, Inc., sus subsidiarios, compañías, divisiones, empleados, oficiales y directores contra de cualquiera y de todas responsabilidades, demandas, penas, pérdidas, juicios, pleitos y los costos incidente además, incluyendo costos de defensa, de acuerdo judicial, y de honorarios razonables del abogado, que pueden ser incurridos en, o como resultado de, la muerte o herida personal a cualquier persona, o daños a cualquier característica, propiedad, contaminación de la tierra o efectos ilícitos en esta Facilidad, causado entero o en parte por el cliente, sus empleados, o sus subcontratistas en botar basura en esta Facilidad. En el caso que el Cliente entrega, bota, basura (según lo determinado por Republic) en este Establecimiento basura inaceptable en los reglamentos de este Establecimiento, el Cliente se compromete asumir todos los costos y obligaciones con el retiro y/o la resolución de cualquier dano(s) causado por la entrega de tal basura inaceptable.



NON-HAZARDOUS WASTE MANIFEST

MANIFEST # 12267

GENERATOR INFORMATION

Generator Name: Tronox LLC
Address: P.O. Box 55
City: Henderson County: Clark
State: NV Zip: 89009
Site Location (if different): 560 W. Lake Mead
Henderson, NV 89015 (702) 592-7727

CUSTOMER/BILLING INFORMATION

Billing Name: NGE LLC c/o Northgate Environment Management
Address: 300 Frank Ogawa Plaza, Ste 510
City: Oakland County: Alameda
State: CA Zip: 94612

Table with 5 columns: Republic Services Approval #, Description of Waste, Volume/Weight, Expiration Date, Container Type. Row 1: 38251011244, Soil for disposal, 34.22 TN, 12-31-2011, Tractor with Dump Trailer(s). Row 2: RZ- #

*Attach Additional Sheet if necessary

I hereby certify that the above-described materials are non-hazardous wastes as defined by 40 CFR 261 or any applicable state law. Further, that the above named materials are properly classified, described, packaged, marked and labeled, and are in proper condition for transportation according to the applicable regulations of the Department of Transportation.

Susan Crowley
Generator/Authorized Agent Name Signature Date Shipped

TRANSPORTER INFORMATION

Transporter Name: Las Vegas Paving DOT # 191949
Address: 4420 S. Decatur Truck Number: MEDO 7
Las Vegas, NV 89103 Phone Number: (702) 353-4355

I certify no hazardous waste or other regulated substance was knowingly introduced to the waste while in my custody. The waste transported in this vehicle is the waste identified above, to the best of my knowledge.

Name of Authorized Agent Signature Date Delivered

DISPOSAL SITE INFORMATION

Site Name: Apex Regional Landfill Phone No. (702) 599-5920
Address: 13550 U.S. Hwy 93 Las Vegas, NV

I hereby acknowledge receipt of the above described materials
Name (Print or Type) Signature Date Received

81 Environmental Tech
13550 N Highway 93
Las Vegas, NV 89165

Ticket Type: INBOUND INVOICE

Ticket Number: 2188
Date: 10/08/2010
Time In: 5:27 pm
Time Out: 5:59 pm

Customer: 001011 - NGE, LLC c/o Northgate Environ Mgmt

Vehicle/Container: 73083P
Contract: Northgate Env. On Site Soils 3825 11
Comment: 3825 10 11244

Gross Weight: 130,680 LB Manual In
Tare Weight: 56,980 LB Manual Out
Net Weight: 73700 LB
Net Tons: 36.85

BOL: 12268

Origin	Yards	Material	Billing Quantity
Not Applicable	0.00 YD	SW CONTAMINATED SOIL	36.85 TN

Driver: _____

Weighmaster: _____

CARTERJ

Indemnification. Customer agrees, by signature above, to indemnify, hold harmless, and defend Republic Services, Inc., its subsidiaries, affiliates, employees, officers and directors from and against any and all liabilities, claims, penalties, forfeitures, suits and the costs and expenses incident thereto, including costs of defense, settlement, and reasonable attorney's fees, which may be incurred, as a result of death or injuries to any person, or damage to any property, contamination of or adverse effects on the environment, caused in whole or in part by the Customer, its employees, or subcontractors in disposing waste at this Facility. In the event Customer delivers Unacceptable Waste (as determined by Republic) Customer agrees to assume all expenses and obligations with the removal and/or resolution of any effects caused by the delivery of such Unacceptable Waste.

Indemnización. Cliente acuerda indemnizar, mantener inmune, y defender Republic Services, Inc., sus subsidiarios, compañías, divisiones, empleados, oficiales y directores contra de cualquiera y de todas responsabilidades, demandas, penas, pérdidas, juicios, pleitos y los costos incidente además, incluyendo costos de defensa, de acuerdo judicial, y de honorarios razonables del abogado, que pueden ser incurridos en, o como resultado de, la muerte o herida personal a cualquier persona, o daños a cualquier característica, propiedad, contaminación de la tierra o efectos ilícitos en esta Facilidad, causado entero o en parte por el cliente, sus empleados, o sus subcontratistas en botar basura en esta Facilidad. En el caso que el Cliente entrega, bota, basura (según lo determinado por Republic) en este Establecimiento basura inaceptable en los reglamentos de este Establecimiento, el Cliente se compromete asumir todos los costos y obligaciones con el retiro y/o la resolución de cualquier dano(s) causado por la entrega de tal basura inaceptable.



NON-HAZARDOUS WASTE MANIFEST

MANIFEST # 12268

GENERATOR INFORMATION

Generator Name: Tronox LLC
Address: P.O. Box 55
City: Henderson County: Clark
State: NV Zip: 89009
Site Location (if different): 560 W. Lake Mead
Henderson, NV 89015 (702) 592-7727

CUSTOMER/BILLING INFORMATION

Billing Name: NGE LLC c/o Northgate Environment Management
Address: 300 Frank Ogawa Plaza, Ste 510
City: Oakland County: Alameda
State: CA Zip: 94612

Table with 5 columns: Republic Services Approval #, Description of Waste, Volume/Weight, Expiration Date, Container Type. Row 1: 38251011244, Soil for disposal, 36.85 TN, 12-31-2011, Tractor with Dump Trailer(s). Row 2: RZ- #

*Attach Additional Sheet if necessary

I hereby certify that the above-described materials are non-hazardous wastes as defined by 40 CFR 261 or any applicable state law. Further, that the above named materials are properly classified, described, packaged, marked and labeled, and are in proper condition for transportation according to the applicable regulations of the Department of Transportation.

Susan Crowley
Generator/Authorized Agent Name Signature Date Shipped

TRANSPORTER INFORMATION

Transporter Name: Las Vegas Paving DOT # 191949
Address: 4420 S. Decatur Truck Number: J&I-35
Las Vegas, NV 89103 Phone Number: (702) 353-4355

I certify no hazardous waste or other regulated substance was knowingly introduced to the waste while in my custody. The waste transported in this vehicle is the waste identified above, to the best of my knowledge.

Juan Parra
Name of Authorized Agent Signature Date Delivered 10-8-10

DISPOSAL SITE INFORMATION

Site Name: Apex Regional Landfill Phone No. (702) 599-5920
Address: 13550 U.S. Hwy 93 Las Vegas, NV

I hereby acknowledge receipt of the above described materials

JASON CARTER
Name (Print or Type) Signature Date Received 10/8/10

81 Environmental Tech
13550 N Highway 93
Las Vegas, NV 89165

Ticket Type: INBOUND INVOICE

Ticket Number: 2189
Date: 10/08/2010
Time In: 5:41 pm
Time Out: 6:05 pm

Customer: 001011 - NGE, LLC c/o Northgate Environ Mgmt

Vehicle/Container: 60573P
Contract: Northgate Env. On Site Soils 3825 11
Comment: 3825 10 11244

Gross Weight: 130,860 LB Manual In
Tare Weight: 57,540 LB Manual Out
Net Weight: 73320 LB
Net Tons: 36.66

BOL: 12270

Origin	Yards	Material	Billing	Quantity
Not Applicable	0.00 YD	SW CONTAMINATED SOIL	36.66	TN

Driver: _____



Weighmaster: _____

CARTERJ 

Indemnification. Customer agrees, by signature above, to indemnify, hold harmless, and defend Republic Services, Inc., its subsidiaries, affiliates, employees, officers and directors from and against any and all liabilities, claims, penalties, forfeitures, suits and the costs and expenses incident thereto, including costs of defense, settlement, and reasonable attorney's fees, which may be incurred, as a result of death or injuries to any person, or damage to any property, contamination of or adverse effects on the environment, caused in whole or in part by the Customer, its employees, or subcontractors in disposing waste at this Facility. In the event Customer delivers Unacceptable Waste (as determined by Republic) Customer agrees to assume all expenses and obligations with the removal and/or resolution of any effects caused by the delivery of such Unacceptable Waste.

Indemnización. Cliente acuerda indemnizar, mantener inmune, y defender Republic Services, Inc., sus subsidiarios, compañías, divisiones, empleados, oficiales y directores contra de cualquiera y de todas responsabilidades, demandas, penas, pérdidas, juicios, pleitos y los costos incidente además, incluyendo costos de defensa, de acuerdo judicial, y de honorarios razonables del abogado, que pueden ser incurridos en, o como resultado de, la muerte o herida personal a cualquier persona, o daños a cualquier característica, propiedad, contaminación de la tierra o efectos ilícitos en esta Facilidad, causado entero o en parte por el cliente, sus empleados, o sus subcontratistas en botar basura en esta Facilidad. En el caso que el Cliente entrega, bota, basura (según lo determinado por Republic) en este Establecimiento basura inaceptable en los reglamentos de este Establecimiento, el Cliente se compromete asumir todos los costos y obligaciones con el retiro y/o la resolución de cualquier dano(s) causado por la entrega de tal basura inaceptable.



NON-HAZARDOUS WASTE MANIFEST

MANIFEST # 12270

GENERATOR INFORMATION

Generator Name: Tronox LLC

Address: P.O. Box 55

City: Henderson County: Clark

State: NV Zip: 89009

Site Location (if different): 560 W. Lake Mead
Henderson, NV 89015 (702) 592-7727

CUSTOMER/BILLING INFORMATION

Billing Name: NGE LLC c/o Northgate Environment Management

Address: 300 Frank Ogawa Plaza, Ste 510

City: Oakland County: Alameda

State: CA Zip: 94612

Table with 5 columns: Republic Services Approval #, Description of Waste, Volume/Weight, Expiration Date, Container Type. Row 1: 38251011244, Soil for disposal, 36.66, 12-31-2011, Tractor with Dump Trailer(s).

*Attach Additional Sheet if necessary

I hereby certify that the above-described materials are non-hazardous wastes as defined by 40 CFR 261 or any applicable state law. Further, that the above named materials are properly classified, described, packaged, marked and labeled, and are in proper condition for transportation according to the applicable regulations of the Department of Transportation.

Susan Crowley (Signature)
Generator/Authorized Agent Name Signature Date Shipped

TRANSPORTER INFORMATION

Transporter Name: Las Vegas Paving

DOT # 191949

Address: 4420 S. Decatur

Truck Number: 142

Las Vegas, NV 89103

Phone Number: (702) 353-4355

I certify no hazardous waste or other regulated substance was knowingly introduced to the waste while in my custody. The waste transported in this vehicle is the waste identified above, to the best of my knowledge.

(Signature)
Name of Authorized Agent Signature Date Delivered 10-8-10

DISPOSAL SITE INFORMATION

Site Name: Apex Regional Landfill

Phone No. (702) 599-5920

Address: 13550 U.S. Hwy 93 Las Vegas, NV

I hereby acknowledge receipt of the above described materials

JASON CARTER (Signature)
Name (Print or Type) Signature Date Received 10/8/10

81 Environmental Tech
13550 N Highway 93
Las Vegas, NV 89165

Ticket Type: INBOUND INVOICE

Ticket Number: 2190
Date: 10/08/2010
Time In: 6:13 pm
Time Out: 6:19 pm

Customer: 001011 - NGE, LLC c/o Northgate Environ Mgmt

Vehicle/Container: Z009877
Contract: Northgate Env. On Site Soils 3825 11
Comment: 3825 10 11244

Gross Weight: 126,140 LB Manual In
Tare Weight: 53,720 LB Manual Out
Net Weight: 72,420 LB
Net Tons: 36.21

BOL: 12271 12273

48300

Origin	Yards	Material	Billing	Quantity
Not Applicable	0.00 YD	SW CONTAMINATED SOIL	36.21	TN

38.92

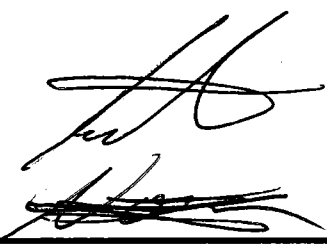
Driver: 

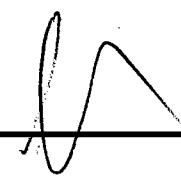
Weighmaster: 
CARTERJ

Indemnification. Customer agrees, by signature above, to indemnify, hold harmless, and defend Republic Services, Inc., its subsidiaries, affiliates, employees, officers and directors from and against any and all liabilities, claims, penalties, forfeitures, suits and the costs and expenses incident thereto, including costs of defense, settlement, and reasonable attorney's fees, which may be incurred, as a result of death or injuries to any person, or damage to any property, contamination of or adverse effects on the environment, caused in whole or in part by the Customer, its employees, or subcontractors in disposing waste at this Facility. In the event Customer delivers Unacceptable Waste (as determined by Republic) Customer agrees to assume all expenses and obligations with the removal and/or resolution of any effects caused by the delivery of such Unacceptable Waste.

Indemnización. Cliente acuerda indemnizar, mantener inmune, y defender Republic Services, Inc., sus subsidiarios, compañías, divisiones, empleados, oficiales y directores contra de cualquiera y de todas responsabilidades, demandas, penas, pérdidas, juicios, pleitos y los costos incidente además, incluyendo costos de defensa, de acuerdo judicial, y de honorarios razonables del abogado, que pueden ser incurridos en, o como resultado de, la muerte o herida personal a cualquier persona, o daños a cualquier característica, propiedad, contaminación de la tierra o efectos ilícitos en esta Facilidad, causado entero o en parte por el cliente, sus empleados, o sus subcontratistas en botar basura en esta Facilidad. En el caso que el Cliente entrega, bota, basura (según lo determinado por Republic) en este Establecimiento basura inaceptable en los reglamentos de este Establecimiento, el Cliente se compromete asumir todos los costos y obligaciones con el retiro y/o la resolución de cualquier dano(s) causado por la entrega de tal basura inaceptable.



NON-HAZARDOUS WASTE MANIFEST

MANIFEST # 12273

GENERATOR INFORMATION

Generator Name: Tronox LLC
Address: P.O. Box 55
City: Henderson County: Clark
State: NV Zip: 89009
Site Location (if different): 560 W. Lake Mead
Henderson, NV 89015 (702) 592-7727

CUSTOMER/BILLING INFORMATION

Billing Name: NGE LLC c/o Northgate Environment Management
Address: 300 Frank Ogawa Plaza, Ste 510
City: Oakland County: Alameda
State: CA Zip: 94612

Table with 5 columns: Republic Services Approval #, Description of Waste, Volume/Weight, Expiration Date, Container Type. Row 1: 38251011244, Soil for disposal, 38.92TN, 12-31-2011, Tractor with Dump Trailer(s)

*Attach Additional Sheet if necessary

I hereby certify that the above-described materials are non-hazardous wastes as defined by 40 CFR 261 or any applicable state law. Further, that the above named materials are properly classified, described, packaged, marked and labeled, and are in proper condition for transportation according to the applicable regulations of the Department of Transportation.

Susan Crowley (Signature)
Generator/Authorized Agent Name Signature Date Shipped

TRANSPORTER INFORMATION

Transporter Name: Las Vegas Paving DOT # 191949
Address: 4420 S. Decatur Truck Number: 2010
Las Vegas, NV 89103 Phone Number: (702) 353-4355

I certify no hazardous waste or other regulated substance was knowingly introduced to the waste while in my custody. The waste transported in this vehicle is the waste identified above, to the best of my knowledge.

(Signature)
Name of Authorized Agent Signature Date Delivered 10.8.10

DISPOSAL SITE INFORMATION

Site Name: Apex Regional Landfill Phone No. (702) 599-5920
Address: 13550 U.S. Hwy 93 Las Vegas, NV

I hereby acknowledge receipt of the above described materials
JASON CARTER (Signature)
Name (Print or Type) Signature Date Received 10/8/10

81 Environmental Tech
13550 N Highway 93
Las Vegas, NV 89165

Ticket Type: INBOUND INVOICE

Ticket Number: 2191
Date: 10/08/2010
Time In: 5:57 pm
Time Out: 6:22 pm

Customer: 001011 - NGE, LLC c/o Northgate Environ Mgmt

Vehicle/Container: 84893P
Contract: Northgate Env. On Site Soils 3825 11
Comment: 3825 10 11244

Gross Weight: 128,880 LB Manual In
Tare Weight: 53,600 LB Manual Out
Net Weight: 75280 LB
Net Tons: 37.64

BOL: 12269

Origin	Yards	Material	Billing Quantity
Not Applicable	0.00 YD	SW CONTAMINATED SOIL	37.64 TN

Driver: _____

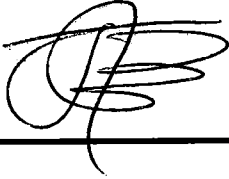

Weighmaster: _____

CARTERJ 

Indemnification. Customer agrees, by signature above, to indemnify, hold harmless, and defend Republic Services, Inc., its subsidiaries, affiliates, employees, officers and directors from and against any and all liabilities, claims, penalties, forfeitures, suits and the costs and expenses incident thereto, including costs of defense, settlement, and reasonable attorney's fees, which may be incurred, as a result of death or injuries to any person, or damage to any property, contamination of or adverse effects on the environment, caused in whole or in part by the Customer, its employees, or subcontractors in disposing waste at this Facility. In the event Customer delivers Unacceptable Waste (as determined by Republic) Customer agrees to assume all expenses and obligations with the removal and/or resolution of any effects caused by the delivery of such Unacceptable Waste.

Indemnización. Cliente acuerda indemnizar, mantener inmune, y defender Republic Services, Inc., sus subsidiarios, compañías, divisiones, empleados, oficiales y directores contra de cualquiera y de todas responsabilidades, demandas, penas, pérdidas, juicios, pleitos y los costos incidente además, incluyendo costos de defensa, de acuerdo judicial, y de honorarios razonables del abogado, que pueden ser incurridos en, o como resultado de, la muerte o herida personal a cualquier persona, o daños a cualquier característica, propiedad, contaminación de la tierra o efectos ilícitos en esta Facilidad, causado entero o en parte por el cliente, sus empleados, o sus subcontratistas en botar basura en esta Facilidad. En el caso que el Cliente entrega, bota, basura (según lo determinado por Republic) en este Establecimiento basura inaceptable en los reglamentos de este Establecimiento, el Cliente se compromete asumir todos los costos y obligaciones con el retiro y/o la resolución de cualquier dano(s) causado por la entrega de tal basura inaceptable.



NON-HAZARDOUS WASTE MANIFEST

MANIFEST # 12269

GENERATOR INFORMATION

Generator Name: Tronox LLC

Address: P.O. Box 55

City: Henderson County: Clark

State: NV Zip: 89009

Site Location (if different): 560 W. Lake Mead

Henderson, NV 89015 (702) 592-7727

CUSTOMER/BILLING INFORMATION

Billing Name: NGE LLC c/o Northgate Environment Management

Address: 300 Frank Ogawa Plaza, Ste 510

City: Oakland County: Alameda

State: CA Zip: 94612

Republic Services Approval #	Description of Waste	Volume/Weight	Expiration Date	Container Type
38251011244	Soil for disposal	37.64TN	12-31-2011	Tractor with Dump Trailer(s)
	RZ- _____ # _____			

*Attach Additional Sheet if necessary

I hereby certify that the above-described materials are non-hazardous wastes as defined by 40 CFR 261 or any applicable state law. Further, that the above named materials are properly classified, described, packaged, marked and labeled, and are in proper condition for transportation according to the applicable regulations of the Department of Transportation.

Susan Crowley
Generator/Authorized Agent Name Signature Date Shipped

TRANSPORTER INFORMATION

Transporter Name: Las Vegas Paving

DOT # 191949

Address: 4420 S. Decatur

Truck Number: 303

Las Vegas, NV 89103

Phone Number: (702) 353-4355

I certify no hazardous waste or other regulated substance was knowingly introduced to the waste while in my custody. The waste transported in this vehicle is the waste identified above, to the best of my knowledge.

Name of Authorized Agent Signature Date Delivered

DISPOSAL SITE INFORMATION

Site Name: Apex Regional Landfill

Phone No. (702) 599-5920

Address: 13550 U.S. Hwy 93 Las Vegas, NV

I hereby acknowledge receipt of the above described materials

Name (Print or Type) Signature Date Received

81 Environmental Tech
13550 N Highway 93
Las Vegas, NV 89165

Ticket Type: INBOUND INVOICE

Ticket Number: 2192
Date: 10/08/2010
Time In: 5:56 pm
Time Out: 6:26 pm

Customer: 001011 - NGE, LLC c/o Northgate Environ Mgmt

Vehicle/Container: 58507P
Contract: Northgate Env. On Site Soils 3825 11
Comment: 3825 10 11244

Gross Weight: 129,100 LB Manual In
Tare Weight: 53,720 LB Manual Out
Net Weight: 75380 LB
Net Tons: 37.69

BOL: 12271

Origin	Yards	Material	Billing Quantity
Not Applicable	0.00 YD	SW CONTAMINATED SOIL	37.69 TN

Driver: _____

Weighmaster: _____

CARTERJ

DRIVER SIGN WRONG TICKET

Indemnification. Customer agrees, by signature above, to indemnify, hold harmless, and defend Republic Services, Inc., its subsidiaries, affiliates, employees, officers and directors from and against any and all liabilities, claims, penalties, forfeitures, suits and the costs and expenses incident thereto, including costs of defense, settlement, and reasonable attorney's fees, which may be incurred, as a result of death or injuries to any person, or damage to any property, contamination of or adverse effects on the environment, caused in whole or in part by the Customer, its employees, or subcontractors in disposing waste at this Facility. In the event Customer delivers Unacceptable Waste (as determined by Republic) Customer agrees to assume all expenses and obligations with the removal and/or resolution of any effects caused by the delivery of such Unacceptable Waste.

Indemnización. Cliente acuerda indemnizar, mantener inmune, y defender Republic Services, Inc., sus subsidiarios, compañías, divisiones, empleados, oficiales y directores contra de cualquiera y de todas responsabilidades, demandas, penas, pérdidas, juicios, pleitos y los costos incidente además, incluyendo costos de defensa, de acuerdo judicial, y de honorarios razonables del abogado, que pueden ser incurridos en, o como resultado de, la muerte o herida personal a cualquier persona, o daños a cualquier característica, propiedad, contaminación de la tierra o efectos ilícitos en esta Facilidad, causado entero o en parte por el cliente, sus empleados, o sus subcontratistas en botar basura en esta Facilidad. En el caso que el Cliente entrega, bota, basura (según lo determinado por Republic) en este Establecimiento basura inaceptable en los reglamentos de este Establecimiento, el Cliente se compromete asumir todos los costos y obligaciones con el retiro y/o la resolución de cualquier dano(s) causado por la entrega de tal basura inaceptable.



NON-HAZARDOUS WASTE MANIFEST

MANIFEST # 12271

GENERATOR INFORMATION

Generator Name: Tronox LLC
Address: P.O. Box 55
City: Henderson County: Clark
State: NV Zip: 89009
Site Location (if different): 560 W. Lake Mead
Henderson, NV 89015 (702) 592-7727

CUSTOMER/BILLING INFORMATION

Billing Name: NGE LLC c/o Northgate Environment Management
Address: 300 Frank Ogawa Plaza, Ste 510
City: Oakland County: Alameda
State: CA Zip: 94612

Table with 5 columns: Republic Services Approval #, Description of Waste, Volume/Weight, Expiration Date, Container Type. Row 1: 38251011244, Soil for disposal, 37.69 TN, 12-31-2011, Tractor with Dump Trailer(s).

*Attach Additional Sheet if necessary

I hereby certify that the above-described materials are non-hazardous wastes as defined by 40 CFR 261 or any applicable state law. Further, that the above named materials are properly classified, described, packaged, marked and labeled, and are in proper condition for transportation according to the applicable regulations of the Department of Transportation.

Susan Crowley
Generator/Authorized Agent Name Signature Date Shipped

TRANSPORTER INFORMATION

Transporter Name: Las Vegas Paving DOT # 191949
Address: 4420 S. Decatur Truck Number: 1020
Las Vegas, NV 89103 Phone Number: (702) 353-4355

I certify no hazardous waste or other regulated substance was knowingly introduced to the waste while in my custody. The waste transported in this vehicle is the waste identified above, to the best of my knowledge.

Name of Authorized Agent Signature Date Delivered

DISPOSAL SITE INFORMATION

Site Name: Apex Regional Landfill Phone No. (702) 599-5920
Address: 13550 U.S. Hwy 93 Las Vegas, NV

I hereby acknowledge receipt of the above described materials
Name (Print or Type) Signature Date Received

81 Environmental Tech
13550 N Highway 93
Las Vegas, NV 89165

Ticket Type: INBOUND INVOICE

Ticket Number: 2193
Date: 10/08/2010
Time In: 6:11 pm
Time Out: 6:40 pm

Customer: 001011 - NGE, LLC c/o Northgate Environ Mgmt

Vehicle/Container: 86680P
Contract: Northgate Env. On Site Soils 3825 11
Comment: 3825 10 11244

Gross Weight: 135,680 LB Manual In
Tare Weight: 55,300 LB Manual Out
Net Weight: 80380 LB
Net Tons: 40.19

BOL: 12272

Origin	Yards	Material	Billing	Quantity
Not Applicable	0.00 YD	SW CONTAMINATED SOIL	40.19	TN

Driver: _____

Weighmaster: _____

CARTERJ

Indemnification. Customer agrees, by signature above, to indemnify, hold harmless, and defend Republic Services, Inc., its subsidiaries, affiliates, employees, officers and directors from and against any and all liabilities, claims, penalties, forfeitures, suits and the costs and expenses incident thereto, including costs of defense, settlement, and reasonable attorney's fees, which may be incurred, as a result of death or injuries to any person, or damage to any property, contamination of or adverse effects on the environment, caused in whole or in part by the Customer, its employees, or subcontractors in disposing waste at this Facility. In the event Customer delivers Unacceptable Waste (as determined by Republic) Customer agrees to assume all expenses and obligations with the removal and/or resolution of any effects caused by the delivery of such Unacceptable Waste.

Indemnización. Cliente acuerda indemnizar, mantener inmune, y defender Republic Services, Inc., sus subsidiarios, compañías, divisiones, empleados, oficiales y directores contra de cualquiera y de todas responsabilidades, demandas, penas, pérdidas, juicios, pleitos y los costos incidente además, incluyendo costos de defensa, de acuerdo judicial, y de honorarios razonables del abogado, que pueden ser incurridos en, o como resultado de, la muerte o herida personal a cualquier persona, o daños a cualquier característica, propiedad, contaminación de la tierra o efectos ilícitos en esta Facilidad, causado entero o en parte por el cliente, sus empleados, o sus subcontratistas en botar basura en esta Facilidad. En el caso que el Cliente entrega, bota, basura (según lo determinado por Republic) en este Establecimiento basura inaceptable en los reglamentos de este Establecimiento, el Cliente se compromete asumir todos los costos y obligaciones con el retiro y/o la resolución de cualquier dano(s) causado por la entrega de tal basura inaceptable.



NON-HAZARDOUS WASTE MANIFEST

MANIFEST # 12272

GENERATOR INFORMATION

Generator Name: Tronox LLC
Address: P.O. Box 55
City: Henderson County: Clark
State: NV Zip: 89009
Site Location (if different): 560 W. Lake Mead
Henderson, NV 89015 (702) 592-7727

CUSTOMER/BILLING INFORMATION

Billing Name: NGE LLC c/o Northgate Environment Management
Address: 300 Frank Ogawa Plaza, Ste 510
City: Oakland County: Alameda
State: CA Zip: 94612

Table with 5 columns: Republic Services Approval #, Description of Waste, Volume/Weight, Expiration Date, Container Type. Row 1: 38251011244, Soil for disposal, 40.19 TN, 12-31-2011, Tractor with Dump Trailer(s)

*Attach Additional Sheet if necessary

I hereby certify that the above-described materials are non-hazardous wastes as defined by 40 CFR 261 or any applicable state law. Further, that the above named materials are properly classified, described, packaged, marked and labeled, and are in proper condition for transportation according to the applicable regulations of the Department of Transportation.

Susan Crowley (Signature)
Generator/Authorized Agent Name Signature Date Shipped

TRANSPORTER INFORMATION

Transporter Name: Las Vegas Paving DOT # 191949
Address: 4420 S. Decatur Truck Number: 58
Las Vegas, NV 89103 Phone Number: (702) 353-4355

I certify no hazardous waste or other regulated substance was knowingly introduced to the waste while in my custody. The waste transported in this vehicle is the waste identified above, to the best of my knowledge.

(Signature)
Name of Authorized Agent Signature Date Delivered 10.8.10

DISPOSAL SITE INFORMATION

Site Name: Apex Regional Landfill Phone No. (702) 599-5920
Address: 13550 U.S. Hwy 93 Las Vegas, NV

I hereby acknowledge receipt of the above described materials
JASON CARTER (Signature)
Name (Print or Type) Signature Date Received 10/8/10

81 Environmental Tech
13550 N Highway 93
Las Vegas, NV 89165

Ticket Type: INBOUND INVOICE

Ticket Number: 2194
Date: 10/08/2010
Time In: 6:21 pm
Time Out: 6:50 pm

Customer: 001011 - NGE, LLC c/o Northgate Environ Mgmt

Vehicle/Container: 86680P
Contract: Northgate Env. On Site Soils 3825 11
Comment: 3825 10 11244

Gross Weight: 128,560 LB Manual In
Tare Weight: 49,920 LB Manual Out
Net Weight: 78640 LB
Net Tons: 39.32

BOL: 12274

Origin	Yards	Material	Billing Quantity
Not Applicable	0.00 YD	SW CONTAMINATED SOIL	39.32 TN

Driver: _____



Weighmaster: _____



CARTERJ

Indemnification. Customer agrees, by signature above, to indemnify, hold harmless, and defend Republic Services, Inc., its subsidiaries, affiliates, employees, officers and directors from and against any and all liabilities, claims, penalties, forfeitures, suits and the costs and expenses incident thereto, including costs of defense, settlement, and reasonable attorney's fees, which may be incurred, as a result of death or injuries to any person, or damage to any property, contamination of or adverse effects on the environment, caused in whole or in part by the Customer, its employees, or subcontractors in disposing waste at this Facility. In the event Customer delivers Unacceptable Waste (as determined by Republic) Customer agrees to assume all expenses and obligations with the removal and/or resolution of any effects caused by the delivery of such Unacceptable Waste.

Indemnización. Cliente acuerda indemnizar, mantener inmune, y defender Republic Services, Inc., sus subsidiarios, compañías, divisiones, empleados, oficiales y directores contra de cualquiera y de todas responsabilidades, demandas, penas, pérdidas, juicios, pleitos y los costos incidente además, incluyendo costos de defensa, de acuerdo judicial, y de honorarios razonables del abogado, que pueden ser incurridos en, o como resultado de, la muerte o herida personal a cualquier persona, o daños a cualquier característica, propiedad, contaminación de la tierra o efectos ilícitos en esta Facilidad, causado entero o en parte por el cliente, sus empleados, o sus subcontratistas en botar basura en esta Facilidad. En el caso que el Cliente entrega, bota, basura (según lo determinado por Republic) en este Establecimiento basura inaceptable en los reglamentos de este Establecimiento, el Cliente se compromete asumir todos los costos y obligaciones con el retiro y/o la resolución de cualquier dano(s) causado por la entrega de tal basura inaceptable.



NON-HAZARDOUS WASTE MANIFEST

MANIFEST # 12274

GENERATOR INFORMATION

Generator Name: Tronox LLC
Address: P.O. Box 55
City: Henderson County: Clark
State: NV Zip: 89009
Site Location (if different): 560 W. Lake Mead
Henderson, NV 89015 (702) 592-7727

CUSTOMER/BILLING INFORMATION

Billing Name: NGE LLC c/o Northgate Environment Management
Address: 300 Frank Ogawa Plaza, Ste 510
City: Oakland County: Alameda
State: CA Zip: 94612

Table with 5 columns: Republic Services Approval #, Description of Waste, Volume/Weight, Expiration Date, Container Type. Row 1: 38251011244, Soil for disposal, 3932, 12-31-2011, Tractor with Dump Trailer(s). Row 2: RZ- #

*Attach Additional Sheet if necessary

I hereby certify that the above-described materials are non-hazardous wastes as defined by 40 CFR 261 or any applicable state law. Further, that the above named materials are properly classified, described, packaged, marked and labeled, and are in proper condition for transportation according to the applicable regulations of the Department of Transportation.

Susan Crowley (Signature)
Generator/Authorized Agent Name Signature Date Shipped

TRANSPORTER INFORMATION

Transporter Name: Las Vegas Paving DOT # 191949
Address: 4420 S. Decatur Truck Number: 110
Las Vegas, NV 89103 Phone Number: (702) 353-4355

I certify no hazardous waste or other regulated substance was knowingly introduced to the waste while in my custody. The waste transported in this vehicle is the waste identified above, to the best of my knowledge.

Name of Authorized Agent Signature Date Delivered 10-8-10

DISPOSAL SITE INFORMATION

Site Name: Apex Regional Landfill Phone No. (702) 599-5920
Address: 13550 U.S. Hwy 93 Las Vegas, NV

I hereby acknowledge receipt of the above described materials
Joe Collins (Signature) Date Received 10-8-10
Name (Print or Type) Signature

REPRINT

81 Environmental Tech
13550 N Highway 93
Las Vegas, NV 89165

Ticket Type: INBOUND INVOICE

Ticket Number: 2195
Date: 10/08/2010
Time In: 7:03 pm
Time Out: 7:27 pm

Customer: 001011 - NGE, LLC c/o Northgate Environ Mgmt

Vehicle/Container: 71893P
Contract: Northgate Env. On Site Soils 3825 10
Comment: 3825 10 11244

Gross Weight: 137,400 LB Manual In
Tare Weight: 53,640 LB Manual Out
Net Weight: 83760 LB
Net Tons: 41.88

BOL: 11275

Origin	Yards	Material	Billing Quantity
Not Applicable	0.00 YD	SW CONTAMINATED SOIL	41.88 TN

Driver: _____

Weighmaster: _____

IN - CARTERJ OUT - SMITHJ

Indemnification. Customer agrees, by signature above, to indemnify, hold harmless, and defend Republic Services, Inc., its subsidiaries, affiliates, employees, officers and directors from and against any and all liabilities, claims, penalties, forfeitures, suits and the costs and expenses incident thereto, including costs of defense, settlement, and reasonable attorney's fees, which may be incurred, as a result of death or injuries to any person, or damage to any property, contamination of or adverse effects on the environment, caused in whole or in part by the Customer, its employees, or subcontractors in disposing waste at this Facility. In the event Customer delivers Unacceptable Waste (as determined by Republic) Customer agrees to assume all expenses and obligations with the removal and/or resolution of any effects caused by the delivery of such Unacceptable Waste.

Indemnización. Cliente acuerda indemnizar, mantener inmune, y defender Republic Services, Inc., sus subsidiarios, compañías, divisiones, empleados, oficiales y directores contra de cualquiera y de todas responsabilidades, demandas, penas, pérdidas, juicios, pleitos y los costos incidente además, incluyendo costos de defensa, de acuerdo judicial, y de honorarios razonables del abogado, que pueden ser incurridos en, o como resultado de, la muerte o herida personal a cualquier persona, o daños a cualquier característica, propiedad, contaminación de la tierra o efectos ilícitos en esta Facilidad, causado entero o en parte por el cliente, sus empleados, o sus subcontratistas en botar basura en esta Facilidad. En el caso que el Cliente entrega, bota, basura (según lo determinado por Republic) en este Establecimiento basura inaceptable en los reglamentos de este Establecimiento, el Cliente se compromete asumir todos los costos y obligaciones con el retiro y/o la resolución de cualquier dano(s) causado por la entrega de tal basura inaceptable.



NON-HAZARDOUS WASTE MANIFEST

MANIFEST # 12275

GENERATOR INFORMATION

Generator Name: Tronox LLC
Address: P.O. Box 55
City: Henderson County: Clark
State: NV Zip: 89009
Site Location (if different): 560 W. Lake Mead
Henderson, NV 89015 (702) 592-7727

CUSTOMER/BILLING INFORMATION

Billing Name: NGE LLC c/o Northgate Environment Management
Address: 300 Frank Ogawa Plaza, Ste 510
City: Oakland County: Alameda
State: CA Zip: 94612

Table with 5 columns: Republic Services Approval #, Description of Waste, Volume/Weight, Expiration Date, Container Type. Row 1: 38251011244, Soil for disposal, 41.88 TN, 12-31-2011, Tractor with Dump Trailer(s).

*Attach Additional Sheet if necessary

I hereby certify that the above-described materials are non-hazardous wastes as defined by 40 CFR 261 or any applicable state law. Further, that the above named materials are properly classified, described, packaged, marked and labeled, and are in proper condition for transportation according to the applicable regulations of the Department of Transportation.

Susan Crowley (Signature)
Generator/Authorized Agent Name Signature Date Shipped

TRANSPORTER INFORMATION

Transporter Name: Las Vegas Paving DOT # 191949
Address: 4420 S. Decatur Truck Number: 07
Las Vegas, NV 89103 Phone Number: (702) 353-4355

I certify no hazardous waste or other regulated substance was knowingly introduced to the waste while in my custody. The waste transported in this vehicle is the waste identified above, to the best of my knowledge.

Name of Authorized Agent Signature Date Delivered 10-8-10

DISPOSAL SITE INFORMATION

Site Name: Apex Regional Landfill Phone No. (702) 599-5920
Address: 13550 U.S. Hwy 93 Las Vegas, NV

I hereby acknowledge receipt of the above described materials
Name (Print or Type) Signature Date Received 10-8-10