

 **KLEINFELDER**

**ENVIRONMENTAL CONDITIONS ASSESSMENT
KERR-MCGEE CHEMICAL CORPORATION
HENDERSON, NEVADA FACILITY**

Prepared by

**KLEINFELDER, INC.
6850 S. Paradise Road
Las Vegas, Nevada 89119**

Prepared for

**KERR-MCGEE CHEMICAL CORPORATION
P.O. Box 55
Henderson, Nevada 89015**

April 1993

**Copyright 1993 Kerr-McGee Chemical Corporation
All Rights Reserved**

**UNAUTHORIZED USE OR COPYING OF THIS DOCUMENT IS STRICTLY
PROHIBITED. PLEASE READ THE "LIMITATIONS" SECTION OF THIS
REPORT.**

A Report Prepared For:

KERR-MCGEE CHEMICAL CORPORATION
P.O. Box 55
Henderson, Nevada 89015

Attention: Mr. Alan Gaddy, Environmental Engineer

Kleinfelder Project No. 31-135909-004

Prepared By:

Todd J. Croft, C.E.M.
Project Geologist
Randolph C. Harris, C.E.M.
Senior Hydrogeologist
Kent E. Zenobia, P.E., C.E.M.
Senior Engineering Consultant

KLEINFELDER, INC.
6850 S. Paradise Road
Las Vegas, Nevada 89119

April 1993

**TABLE OF CONTENTS
ENVIRONMENTAL CONDITIONS ASSESSMENT
KERR-MCGEE CHEMICAL CORPORATION
HENDERSON FACILITY**

<u>Chapter</u>		<u>Page No.</u>
1.0	EXECUTIVE SUMMARY	1-1
2.0	INTRODUCTION	2-1
2.1	Requirements of the Consent Agreement.....	2-1
2.2	Purpose and Scope of the Environmental Conditions Assessment (ECA).....	2-2
2.2.1	Purpose of the ECA	2-2
2.2.2	Scope of the ECA.....	2-3
2.3	Technical Approach to ECA Process.....	2-4
2.3.1	Preliminary Review (PR).....	2-4
2.3.2	Agency Actions After Review of the ECA.....	2-4
2.4	Limitations	2-8
3.0	FACILITY BACKGROUND INFORMATION.....	3-1
3.1	Site History and Overview	3-1
3.1.1	General	3-1
3.1.2	U.S. Government Activities.....	3-4
3.1.3	Other Previous Lessees on KMCC Property	3-6
3.1.4	Previous Operating Companies	3-7
3.1.5	Kerr-McGee Chemical Corporation Activities.....	3-11
3.2	Site and Geologic Conditions	3-15
3.2.1	Location and Climate.....	3-15
3.2.2	Regional Geology.....	3-17
3.2.3	Regional Hydrogeology.....	3-17
3.2.4	Site-Specific Geologic, Hydrogeologic, Topographic and Drainage Conditions.....	3-19
4.0	INDUSTRIAL PROCESSES AND WASTES GENERATED	4-1
4.1	Sodium Chlorate Process	4-2
4.1.1	General Description	4-2
4.1.2	Raw Materials Used	4-5
4.1.3	Production Process Flow Description.....	4-5
4.1.4	Waste Stream Characterization	4-10

Chapter

Page No.

4.2	Potassium Chlorate Process (Unit 4).....	4-14
4.2.1	General Description	4-14
4.2.2	Raw Materials Used	4-15
4.2.3	Production Process Flow Description.....	4-15
4.2.4	Waste Stream Characterization	4-16
4.3	Tumbleaf® Defoliant Process (North of Unit 5)	4-18
4.3.1	General Description	4-18
4.3.2	Raw Materials Used	4-18
4.3.3	Production Process Flow Description.....	4-19
4.3.4	Waste Stream Characterization	4-19
4.4	Sodium Perchlorate Process (Unit 5)	4-20
4.4.1	General Description	4-20
4.4.2	Raw Materials Used	4-21
4.4.3	Production Process flow Description	4-21
4.4.4	Waste Stream Characterization	4-22
4.5	Potassium Perchlorate Process (Unit 4)	4-25
4.5.1	General Description	4-25
4.5.2	Raw Materials Used	4-27
4.5.3	Production Process Flow Description.....	4-27
4.5.4	Waste Stream Characterization	4-28
4.6	Magnesium Perchlorate Process (Unit 5)	4-30
4.6.1	General Description	4-30
4.6.2	Raw Materials Used	4-30
4.6.3	Production Process Flow Description.....	4-31
4.6.4	Waste Stream Characterization	4-31
4.7	Ammonium Perchlorate Process.....	4-34
4.7.1	General Description	4-34
4.7.2	Raw Materials Used	4-36
4.7.3	Production Process Flow Description.....	4-36
4.7.4	Waste Stream Characterization	4-40
4.8	Manganese Dioxide Process (Unit 6)	4-43
4.8.1	General Description	4-43
4.8.2	Raw Materials Used	4-45
4.8.3	Production Process Flow Description.....	4-45
4.8.4	Waste Stream Characterization	4-46

<u>Chapter</u>	<u>Page No.</u>
4.9 Manganese Dioxide Leach Plant Process	4-50
4.9.1 General Description	4-50
4.9.2 Raw Materials Used	4-50
4.9.3 Production Process Flow Description	4-50
4.9.4 Waste Stream Characterization	4-51
4.10 Elemental Boron Process (Unit 5).....	4-56
4.10.1 General Description	4-56
4.10.2 Raw Materials Used	4-56
4.10.3 Production Process Flow Description	4-57
4.10.4 Waste Stream Characterization	4-57
4.11 Boron Trichloride Process (Unit 5)	4-60
4.11.1 General Description	4-60
4.11.2 Raw Materials	4-60
4.11.3 Production Process Flow Description	4-61
4.11.4 Waste Stream Characterization	4-63
4.12 Boron Tribromide Process (Unit 5)	4-65
4.12.1 General Description	4-65
4.12.2 Raw Materials Used	4-66
4.12.3 Production Process Flow Description	4-66
4.12.4 Waste Stream Characterization	4-66
4.13 Steam Plant Process	4-68
4.13.1 General Description	4-68
4.13.2 Raw Materials Used	4-68
4.13.3 Production Process Flow Description	4-69
4.13.4 Waste Steam Characterization	4-70
5.0 WASTE MANAGEMENT UNITS AND AREAS.....	5-1
5.1 "Process Hardware" Storage Area Between Units 1 and 2	5-1
5.1.1 Unit/Area Design and Operational History	5-1
5.1.2 Unit/Area Waste Characteristics.....	5-2
5.1.3 Regulatory Status of Unit.....	5-3
5.1.4 Waste Constituent Migration Pathways.....	5-3
5.1.5 Evidence of Releases and Potential Environmental Impacts.....	5-3
5.1.6 Analysis of Release Prevention or Mitigation Measures	5-3

Chapter

Page No.

5.2	Trash Storage Area North of Units 1 and 2.....	5-3
5.2.1	Unit/Area Design and Operational History	5-3
5.2.2	Unit/Area Waste Characteristics.....	5-4
5.2.3	Regulatory Status of Unit.....	5-4
5.2.4	Waste Constituent Migration Pathways.....	5-5
5.2.5	Evidence of Releases and Potential Environmental Impacts.....	5-5
5.2.6	Analysis of Release Prevention or Mitigation Measures	5-5
5.3	PCB Storage Area - Unit 2.....	5-5
5.3.1	Unit/Area Design and Operational History	5-5
5.3.2	Unit/Area Waste Characteristics.....	5-6
5.3.3	Regulatory Status of Unit.....	5-6
5.3.4	Waste Constituent Migration Pathways.....	5-7
5.3.5	Evidence of Releases and Potential Environmental Impacts.....	5-7
5.3.6	Analysis of Release Prevention or Mitigation Measures	5-7
5.4	Hazardous Waste Storage Area North of Unit 2	5-7
5.4.1	Unit/Area Design and Operational History	5-7
5.4.2	Unit/Area Waste Characteristics.....	5-9
5.4.3	Regulatory Status of Unit.....	5-9
5.4.4	Waste Constituent Migration Pathways.....	5-9
5.4.5	Evidence of Releases and Potential Environmental Impacts.....	5-9
5.4.6	Analysis of Release Prevention or Mitigation Measures	5-9
5.5	Sodium Chlorate Filter Cake Holding Area North of Unit 3.....	5-10
5.5.1	Unit/Area Design and Operational History	5-10
5.5.2	Unit/Area Waste Characteristics.....	5-11
5.5.3	Regulatory Status of Unit.....	5-12
5.5.4	Waste Constituent Migration Pathways.....	5-12
5.5.5	Evidence of Releases and Potential Environmental Impacts.....	5-12
5.5.6	Analysis of Release Prevention or Mitigation Measures	5-12
5.6	Hazardous Waste Storage Area Between Units 3 and 4	5-13
5.6.1	Unit/Area Design and Operational History	5-13
5.6.2	Unit/Area Waste Characteristics.....	5-14
5.6.3	Regulatory Status of Unit.....	5-14
5.6.4	Waste Constituent Migration Pathways.....	5-14
5.6.5	Evidence of Releases and Potential Environmental Impacts.....	5-15
5.6.6	Analysis of Release Prevention or Mitigation Measures	5-15

Chapter

Page No.

5.7	Platinum Drying Unit North of Unit 4	5-15
5.7.1	Unit/Area Design and Operational History	5-15
5.7.2	Unit/Area Waste Characteristics	5-16
5.7.3	Regulatory Status of Unit	5-17
5.7.4	Waste Constituent Migration Pathways	5-17
5.7.5	Evidence of Releases and Potential Environmental Impacts	5-17
5.7.6	Analysis of Release Prevention or Mitigation Measures	5-18
5.8	Solid Waste Dumpsters	5-18
5.8.1	Unit/Area Design and Operational History	5-18
5.8.2	Unit/Area Waste Characteristics	5-19
5.8.3	Regulatory Status of Unit	5-19
5.8.4	Waste Constituent Migration Pathways	5-19
5.8.5	Evidence of Releases and Potential Environmental Impacts	5-19
5.8.6	Analysis of Release Prevention or Mitigation Measures	5-20
5.9	Manganese Tailings Area	5-20
5.9.1	Unit/Area Design and Operational History	5-20
5.9.2	Unit/Area Waste Characteristics	5-21
5.9.3	Regulatory Status of Unit	5-21
5.9.4	Waste Constituent Migration Pathways	5-22
5.9.5	Evidence of Releases and Potential Environmental Impacts	5-22
5.9.6	Analysis of Release Prevention or Mitigation Measures	5-23
5.10	Old P-2 Surface Impoundment	5-23
5.10.1	Unit/Area Design and Operational History	5-23
5.10.2	Unit/Area Waste Characteristics	5-25
5.10.3	Regulatory Status of Unit	5-25
5.10.4	Waste Constituent Migration Pathways	5-26
5.10.5	Evidence of Releases and Potential Environmental Impacts	5-26
5.10.6	Analysis of Release Prevention or Mitigation Measures	5-26
5.11	C-1 Surface Impoundment	5-27
5.11.1	Unit/Area Design and Operational History	5-27
5.11.2	Unit/Area Waste Characteristics	5-28
5.11.3	Regulatory Status of Unit	5-29
5.11.4	Waste Constituent Migration Pathways	5-30
5.11.5	Evidence of Releases and Potential Environmental Impacts	5-30
5.11.6	Analysis of Release Prevention or Mitigation Measures	5-31

Chapter

Page No.

5.12	Mn-1 Surface Impoundment	5-31
	5.12.1 Unit/Area Design and Operational History	5-31
	5.12.2 Unit/Area Waste Characteristics.....	5-32
	5.12.3 Regulatory Status of Unit.....	5-32
	5.12.4 Waste Constituent Migration Pathways.....	5-33
	5.12.5 Evidence of Releases and Potential Environmental Impacts.....	5-33
	5.12.6 Analysis of Release Prevention or Mitigation Measures	5-33
5.13	Hazardous Waste Landfill (Closed).....	5-33
	5.13.1 Unit/Area Design and Operational History	5-33
	5.13.2 Unit/Area Waste Characteristics.....	5-35
	5.13.3 Regulatory Status of Unit.....	5-35
	5.13.4 Waste Constituent Migration Pathways.....	5-36
	5.13.5 Evidence of Releases and Potential Environmental Impacts.....	5-37
	5.13.6 Analysis of Release Prevention or Mitigation Measures	5-37
5.14	Trade Effluent Settling Ponds (U.S. Government Operations)	5-38
	5.14.1 Unit/Area Design and Operational History	5-38
	5.14.2 Unit/Area Waste Characteristics.....	5-40
	5.14.3 Regulatory Status of Unit.....	5-41
	5.14.4 Waste Constituent Migration Pathways.....	5-41
	5.14.5 Evidence of Releases and Potential Environmental Impacts.....	5-41
	5.14.6 Analysis of Release Prevention or Mitigation Measures	5-42
5.15	WC-1 (WC-West) Surface Impoundment	5-42
	5.15.1 Unit/Area Design and Operational History	5-42
	5.15.2 Unit/Area Waste Characteristics.....	5-44
	5.15.3 Regulatory Status of Unit.....	5-45
	5.15.4 Waste Constituent Migration Pathways.....	5-45
	5.15.5 Evidence of Releases and Potential Environmental Impacts.....	5-45
	5.15.6 Analysis of Release Prevention or Mitigation Measures	5-46
5.16	WC-2 (WC-East) Surface Impoundment.....	5-46
	5.16.1 Unit/Area Design and Operational History	5-46
	5.16.2 Unit/Area Waste Characteristics.....	5-47
	5.16.3 Regulatory Status of Unit.....	5-48
	5.16.4 Waste Constituent Migration Pathways.....	5-49
	5.16.5 Evidence of Releases and Potential Environmental Impacts.....	5-49
	5.16.6 Analysis of Release Prevention or Mitigation Measures	5-49

Chapter

Page No.

5.17	Ammonium Perchlorate (AP) Area - Pad 35	5-49
5.17.1	Unit/Area Design and Operational History	5-49
5.17.2	Unit/Area Waste Characteristics.....	5-50
5.17.3	Regulatory Status of Unit.....	5-51
5.17.4	Waste Constituent Migration Pathways.....	5-51
5.17.5	Evidence of Releases and Potential Environmental Impacts.....	5-51
5.17.6	Analysis of Release Prevention or Mitigation Measures	5-51
5.18	Drum Crushing Area.....	5-52
5.18.1	Unit/Area Design and Operational History	5-52
5.18.2	Unit/Area Waste Characteristics.....	5-53
5.18.3	Regulatory Status of Unit.....	5-53
5.18.4	Waste Constituent Migration Pathways.....	5-53
5.18.5	Evidence of Releases and Potential Environmental Impacts.....	5-53
5.18.6	Analysis of Release Prevention or Mitigation Measures	5-53
5.19	Groundwater Remediation Unit.....	5-55
5.19.1	Unit/Area Design and Operational History	5-55
5.19.2	Unit/Area Waste Characteristics.....	5-60
5.19.3	Regulatory Status of Unit.....	5-60
5.19.4	Waste Constituent Migration Pathways.....	5-62
5.19.5	Evidence of Releases and Potential Environmental Impacts.....	5-62
5.19.6	Analysis of Release Prevention or Mitigation Measures	5-63
5.20	The Beta Ditch	5-63
5.20.1	Unit/Area Design and Operational History	5-63
5.20.2	Unit/Area Waste Characteristics.....	5-66
5.20.3	Regulatory Status of Unit.....	5-69
5.20.4	Waste Constituent Migration Pathways.....	5-69
5.20.5	Evidence of Releases and Potential Environmental Impacts.....	5-69
5.20.6	Analysis of Release Prevention or Mitigation Measures	5-70
5.21	Sodium Perchlorate Platinum By-Product Filter - Unit 5.....	5-71
5.21.1	Unit/Area Design and Operational History	5-71
5.21.2	Unit/Area Waste Characteristics.....	5-72
5.21.3	Regulatory Status of Unit.....	5-72
5.21.4	Waste Constituent Migration Pathways.....	5-72
5.21.5	Evidence of Releases and Potential Environmental Impacts.....	5-73
5.21.6	Analysis of Release Prevention or Mitigation Measures	5-73

Chapter

Page No.

5.22	Former Manganese Tailings Area.....	5-73
5.22.1	Unit/Area Design and Operational History	5-73
5.22.2	Unit/Area Waste Characteristics.....	5-75
5.22.3	Regulatory Status of Unit.....	5-75
5.22.4	Waste Constituent Migration Pathways.....	5-76
5.22.5	Evidence of Releases and Potential Environmental Impacts.....	5-76
5.22.6	Analysis of Release Prevention or Mitigation Measures	5-76
5.23	Closed Surface Impoundment S-1	5-77
5.23.1	Unit/Area Design and Operational History	5-77
5.23.2	Unit/Area Waste Characteristics.....	5-78
5.23.3	Regulatory Status of Unit.....	5-79
5.23.4	Waste Constituent Migration Pathways.....	5-79
5.23.5	Evidence of Releases and Potential Environmental Impacts.....	5-80
5.23.6	Analysis of Release Prevention or Mitigation Measures	5-80
5.24	Closed Surface Impoundment P-1.....	5-81
5.24.1	Unit/Area Design and Operational History	5-81
5.24.2	Unit/Area Waste Characteristics.....	5-82
5.24.3	Regulatory Status of Unit.....	5-83
5.24.4	Waste Constituent Migration Pathways.....	5-83
5.24.5	Evidence of Releases and Potential Environmental Impacts.....	5-83
5.24.6	Analysis of Release Prevention or Mitigation Measures	5-84
5.25	Truck Emptying/Dump Site.....	5-84
5.25.1	Unit/Area Design and Operational History	5-84
5.25.2	Unit/Area Waste Characteristics.....	5-85
5.25.3	Regulatory Status of Unit.....	5-85
5.25.4	Waste Constituent Migration Pathways.....	5-85
5.25.5	Evidence of Releases and Potential Environmental Impacts.....	5-85
5.25.6	Analysis of Release Prevention or Mitigation Measures	5-86
5.26	Former Satellite Accumulation Point - Unit 3, Maintenance Shop.....	5-86
5.26.1	Unit/Area Design and Operational History	5-86
5.26.2	Unit/Area Waste Characteristics.....	5-87
5.26.3	Regulatory Status of Unit.....	5-87
5.26.4	Waste Constituent Migration Pathways.....	5-87
5.26.5	Evidence of Releases and Potential Environmental Impacts.....	5-88
5.26.6	Analysis of Release Prevention or Mitigation Measures	5-88

Chapter

Page No.

5.27	Former Satellite Accumulation Point - Unit 6, Maintenance Shop.....	5-88
5.27.1	Unit/Area Design and Operational History	5-88
5.27.2	Unit/Area Waste Characteristics.....	5-88
5.27.3	Regulatory Status of Unit.....	5-89
5.27.4	Waste Constituent Migration Pathways.....	5-89
5.27.5	Evidence of Releases and Potential Environmental Impacts.....	5-89
5.27.6	Analysis of Release Prevention or Mitigation Measures	5-90
5.28	Satellite Accumulation Point-AP Laboratory	5-90
5.28.1	Unit/Area Design and Operational History	5-90
5.28.2	Unit/Area Waste Characteristics.....	5-91
5.28.3	Regulatory Status of Unit.....	5-91
5.28.4	Waste Constituent Migration Pathways.....	5-91
5.28.5	Evidence of Releases and Potential Environmental Impacts.....	5-92
5.28.6	Analysis of Release Prevention or Mitigation Measures	5-92
5.29	Satellite Accumulation Point - AP Maintenance Shop	5-92
5.29.1	Unit/Area Design and Operational History	5-92
5.29.2	Unit/Area Waste Characteristics.....	5-93
5.29.3	Regulatory Status of Unit.....	5-93
5.29.4	Waste Constituent Migration Pathways.....	5-93
5.29.5	Evidence of Releases and Potential Environmental Impacts.....	5-93
5.29.6	Analysis of Release Prevention or Mitigation Measures	5-94
5.30	Storm Sewer System	5-96
5.30.1	Unit/Area Design and Operational History	5-96
5.30.2	Unit/Area Waste Characteristics.....	5-97
5.30.3	Regulatory Status of Unit.....	5-98
5.30.4	Waste Constituent Migration Pathways.....	5-98
5.30.5	Evidence of Releases and Potential Environmental Impacts.....	5-98
5.30.6	Analysis of Release Prevention or Migration Measure.....	5-99
5.31	Acid Drain System	
5.31.1	Unit/Area Design and Operational History	5-99
5.31.2	Unit/Area Waste Characteristics.....	5-100
5.31.3	Regulatory Status of Unit.....	5-101
5.31.4	Waste Constituent Migration Pathways.....	5-102
5.31.5	Evidence of Releases and Potential Environmental Impacts.....	5-102
5.31.6	Analysis of Release Prevention or Mitigation Measures	5-102

6.0	KNOWN OR SUSPECTED RELEASES OR SPILLS	6-1
6.1	PCB Transformers.....	6-1
6.1.1	Description of Spill/Release.....	6-1
6.1.2	Analysis of Response Measures.....	6-2
6.1.3	Contaminant Migration Pathways	6-2
6.1.4	Evidence of Existing Environmental Impacts.....	6-2
6.2	Unit 1 Tenants - Stains.....	6-3
6.2.1	Description of Spill/Release.....	6-3
6.2.2	Analysis of Response Measures.....	6-3
6.2.3	Contaminant Migration Pathways	6-3
6.2.4	Evidence of Existing Environmental Impacts.....	6-3
6.3	Unit 2 Salt Redler	6-4
6.3.1	Description of Spill/Release.....	6-4
6.3.2	Analysis of Response Measures.....	6-4
6.3.3	Contaminant Migration Pathways	6-4
6.3.4	Evidence of Existing Environmental Impacts.....	6-4
6.4	Unit 4 and Unit 5 Basements - Consent Agreement	6-5
6.4.1	Description of Spill/Release.....	6-5
6.4.2	Analysis of Response Measures.....	6-5
6.4.3	Contaminant Migration Pathways	6-6
6.4.4	Evidence of Existing Environmental Impacts.....	6-6
6.5	Unit 6 Basements - Remediation Project	6-6
6.5.1	Description of Spill/Release.....	6-6
6.5.2	Analysis of Response Measures.....	6-7
6.5.3	Contaminant Migration Pathways	6-7
6.5.4	Evidence of Existing Environmental Impacts.....	6-8
6.6	Diesel Storage Tank Area - Stains	6-8
6.6.1	Description of Spill/Release.....	6-8
6.6.2	Analysis of Response Measures.....	6-8
6.6.3	Contaminant Migration Pathways	6-9
6.6.4	Evidence of Existing Environmental Impacts.....	6-9
6.7	Former Old Main Cooling Tower and Recirculation Lines.....	6-9
6.7.1	Description of Spill/Release.....	6-9
6.7.2	Analysis of Response Measures.....	6-11
6.7.3	Contaminant Migration Pathways	6-11
6.7.4	Evidence of Existing Environmental Impacts.....	6-12

Chapter

Page No.

6.8	Leach Plant Area Manganese Ore Piles	6-12
6.8.1	Description of Spill/Release.....	6-12
6.8.2	Analysis of Response Measures.....	6-13
6.8.3	Contaminant Migration Pathways	6-13
6.8.4	Evidence of Existing Environmental Impacts.....	6-13
6.9	Leach Plant Area Anolyte Tanks	6-15
6.9.1	Description of Spill/Release.....	6-15
6.9.2	Analysis of Response Measures.....	6-16
6.9.3	Contaminant Migration Pathways	6-17
6.9.4	Evidence of Existing Environmental Impacts.....	6-17
6.10	Leach Plant Area Sulfuric Acid Storage Tank.....	6-17
6.10.1	Description of Spill/Release.....	6-17
6.10.2	Analysis of Response Measures.....	6-18
6.10.3	Contaminant Migration Pathways	6-18
6.10.4	Evidence of Existing Environmental Impacts.....	6-18
6.11	Leach Plant Area Leach Tanks	6-19
6.11.1	Description of Spill/Release.....	6-19
6.11.2	Analysis of Response Measures.....	6-20
6.11.3	Contaminant Migration Pathways	6-20
6.11.4	Evidence of Existing Environmental Impacts.....	6-20
6.12	Leach Plant Area Transfer Lines To/From Unit 6.....	6-21
6.12.1	Description of Spill/Release.....	6-21
6.12.2	Analysis of Response Measures.....	6-22
6.12.3	Contaminant Migration Pathways	6-22
6.12.4	Evidence of Existing Environmental Impacts.....	6-23
6.13	AP Plant Area Screening Building, Dryer Building, and Associated Sump.....	6-23
6.13.1	Description of Spill/Release.....	6-23
6.13.2	Analysis of Response Measures.....	6-24
6.13.3	Contaminant Migration Pathways	6-24
6.13.4	Evidence of Existing Environmental Impacts.....	6-24
6.14	AP Plant Area Tank Farm.....	6-25
6.14.1	Description of Spill/Release.....	6-25
6.14.2	Analysis of Response Measures.....	6-26
6.14.3	Contaminant Migration Pathways	6-26
6.14.4	Evidence of Existing Environmental Impacts.....	6-26

Chapter

Page No.

6.15	AP Plant Area Change House/Lab Septic Tank.....	6-27
	6.15.1 Description of Spill/Release.....	6-27
	6.15.2 Analysis of Response Measures.....	6-27
	6.15.3 Contaminant Migration Pathways	6-28
	6.15.4 Evidence of Existing Environmental Impacts.....	6-28
6.16	AP Plant Area Storage Pads - Fire.....	6-28
	6.16.1 Description of Spill/Release.....	6-28
	6.16.2 Analysis of Response Measures.....	6-29
	6.16.3 Contaminant Migration Pathways	6-29
	6.16.4 Evidence of Existing Environmental Impacts.....	6-29
6.17	AP Plant Area Old Building D-1 - Wash Down	6-29
	6.17.1 Description of Spill/Release.....	6-29
	6.17.2 Analysis of Response Measures.....	6-30
	6.17.3 Contaminant Migration Pathways	6-30
	6.17.4 Evidence of Existing Environmental Impacts.....	6-30
6.18	AP Plant Area New Building D-1 - Wash Down	6-30
	6.18.1 Description of Spill/Release.....	6-30
	6.18.2 Analysis of Response Measures.....	6-31
	6.18.3 Contaminant Migration Pathways	6-31
	6.18.4 Evidence of Existing Environmental Impacts.....	6-31
6.19	AP Plant SIs and Transfer Lines To/From AP SIs	6-31
	6.19.1 Description of Spill/Release.....	6-31
	6.19.2 Analysis of Response Measures.....	6-33
	6.19.3 Contaminant Migration Pathways	6-33
	6.19.4 Evidence of Existing Environmental Impacts.....	6-34
6.20	AP Plant Transfer Lines to Sodium Chlorate Process.....	6-34
	6.20.1 Description of Spill/Release.....	6-34
	6.20.2 Analysis of Response Measures.....	6-35
	6.20.3 Contaminant Migration Pathways	6-35
	6.20.4 Evidence of Existing Environmental Impacts.....	6-35

Chapter

Page No.

7.0	MISCELLANEOUS ACTIVITIES	7-1
7.1	BMI Common Area Disposal (Upper and Lower BMI Ponds)	7-1
	7.1.1 History and Description of Activity	7-1
	7.1.2 Results and Analysis of Activity	7-5
	7.1.3 Potential or Known Releases or Environmental Impacts Related to Activity	7-6
7.2	BMI Common Area Disposal (BMI Landfill)	7-7
	7.2.1 History and Description of Activity	7-7
	7.2.2 Results and Analysis of Activity	7-9
	7.2.3 Potential or Known Releases or Environmental Impacts Related to Activity	7-10
7.3	Old Sodium Chlorate Plant Decommissioning	7-10
	7.3.1 History and Description of Activity	7-10
	7.3.2 Results and Analysis of Activity	7-11
	7.3.3 Potential or Known Releases or Environmental Impacts Related to Activity	7-11
7.4	State Industries, Inc. (KMCC Tenant)	7-11
	7.4.1 History and Description of Activity	7-11
	7.4.2 Results and Analysis of Activity	7-15
	7.4.3 Potential or Known Releases or Environmental Impacts Related to Activity	7-16
7.5	J.B. Kelley, Inc. Trucking (KMCC Tenant)	7-17
	7.5.1 History and Description of Activity	7-17
	7.5.2 Results and Analysis of Activity	7-19
	7.5.3 Potential or Known Releases or Environmental Impacts Related to Activity	7-20
7.6	Koch Materials Company (KMCC Tenant)	7-21
	7.6.1 History and Description of Activity	7-21
	7.6.2 Results and Analysis of Activity	7-22
	7.6.3 Potential or Known Releases or Environmental Impacts Related to Activity	7-22

Chapter

Page No.

7.7	Nevada Precast Concrete Products (KMCC Tenant)	7-23
7.7.1	History and Description of Activity	7-23
7.7.2	Results and Analysis of Activity	7-23
7.7.3	Potential or Known Releases or Environmental Impacts Related to Activity	7-23
7.8	Green Ventures International (KMCC Tenant)	7-23
7.8.1	History and Description of Activity	7-23
7.8.2	Results and Analysis of Activity	7-24
7.8.3	Potential or Known Releases or Environmental Impacts Related to Activity	7-24
7.9	Buckles Construction Company (KMCC Tenant)	7-24
7.9.1	History and Description of Activity	7-24
7.9.2	Results and Analysis of Activity	7-24
7.9.3	Potential or Known Releases or Environmental Impacts Related to Activity	7-24
7.10	Ebony Construction Company (KMCC Tenant)	7-25
7.10.1	History and Description of Activity	7-25
7.10.2	Results and Analysis of Activity	7-25
7.10.3	Potential or Known Releases or Environmental Impacts Related to Activity	7-25
7.11	Flintkote Company (KMCC Tenant)	7-25
7.11.1	History and Description of Activity	7-25
7.11.2	Results and Analysis of Activity	7-26
7.11.3	Potential or Known Releases or Environmental Impacts Related to Activity	7-26
7.12	Delbert Madsen & Estate of Delbert Madsen (KMCC Tenant)	7-26
7.12.1	History and Description of Activity	7-26
7.12.2	Results and Analysis of Activity	7-26
7.12.3	Potential or Known Releases or Environmental Impacts Related to Activity	7-26
7.13	Southern Nevada Auto Parts (SNAP) Area (KMCC Tenants)	7-27
7.13.1	History and Description of Activity	7-27
7.13.2	Results and Analysis of Activity	7-27
7.13.3	Potential or Known Releases or Environmental Impacts Related to Activity	7-28

Chapter

Page No.

7.14	Dillon Potter (KMCC Tenant).....	7-28
7.14.1	History and Description of Activity.....	7-28
7.14.2	Results and Analysis of Activity.....	7-28
7.14.3	Potential or Known Releases or Environmental Impacts Related to Activity.....	7-28
8.0	RECOMMENDATIONS.....	8-1

Appendices

- A. References
- B. Plates
- C. Index of Wastes
- D. Index of SWMUs and Areas of Known or Suspected Releases or Spills
- E. SWMU Maps and Release/Spill Map
- F. Parcel Description and Ownership Information

Tables

3.1.1	List of Previous Operating Entities at the KMCC Site.....	3-1
3.1.2	Product Summary For WECCO.....	3-8
3.1.3	Summary of Waste Information For WECCO	3-9
3.1.4	Product Summary For AP & CC	3-10
3.1.5	Summary of Waste Information For AP & CC	3-10
3.1.6	Products, Estimated Amounts, and Years Produced at the KMCC Facility	3-11
3.1.7	Summary of Waste Information for KMCC	3-13
4.1.1	Sodium Chlorate Production - Tons	4-3
4.2.1	Potassium Chlorate Production - Tons	4-12
4.3.1	Tumbleleaf® Production - Tons.....	4-16
4.4.1	Sodium Perchlorate Production - Tons.....	4-18
4.5.1	Potassium Perchlorate Production - Tons.....	4-23
4.6.1	Magnesium Perchlorate Production - Tons	4-27
4.7.1	Ammonium Perchlorate Production - Tons.....	4-31
4.8.1	Manganese Dioxide Production - Tons.....	4-39
4.10.1	Elemental Boron Production - Pounds.....	4-51
4.11.1	Boron Trichloride Production - Pounds	4-55
4.12.1	Boron Tribromide Production - Pounds.....	4-60
5.11.1	1989 Annual Waste Stream Analyses.....	5-26
5.15.1	1990 Annual Waste Stream Analyses.....	5-42
5.16.1	1990 Annual Waste Stream Analyses.....	5-46
5.20.1	Average Discharge to the Beta Ditch (Pre 1976)	5-63
7.1.1	Average Discharge to the Beta Ditch (Pre January 1976)	7-4
7.6.1	State Industries, Inc. Estimated Annual Usage of Raw Materials (1980)	7-16
C-1	Index of Wastes.....	C-2

Figures

4.1.1	Sodium Chlorate Recovery Flow Diagram	4-10
4.1.2	Sodium Chlorate Process Flow Diagram.....	4-11
4.2.1	Potassium Chlorate Process Flow Diagram.....	4-15
4.4.1	Sodium Perchlorate Process Flow Diagram	4-21
4.5.1	Potassium Perchlorate Process Flow Diagram	4-26
4.6.1	Magnesium Perchlorate Process Flow Diagram	4-29
4.7.1	Simplified Ammonium Perchlorate Process Flow Diagram.....	4-37
4.8.1	Manganese Dioxide Process (Electrolysis Portion) Flow Diagram	4-42
4.8.2	Manganese Dioxide Process (Processing Portion - Unit 6A) Flow Diagram	4-43
4.8.3	Manganese Dioxide Process (Processing Portion - Unit 6B) Flow Diagram	4-44
4.9.1	Manganese Dioxide Leach Plant Process (Calcining Portion) Flow Diagram	4-48
4.9.2	Manganese Dioxide Leach Plant Process (Leaching Portion) Flow Diagram	4-49
4.9.3	Manganese Dioxide Leach Plant Process (Purification Portion) Flow Diagram ..	4-50
4.10.1	Elemental Boron Process Flow Diagram.....	4-54
4.11.1	Boron Trichloride Process Flow Diagram.....	4-59
4.12.1	Boron Tribromide Process Flow Diagram.....	4-62

Plates

Appendix

2-1	Site Location	B
3-1	BMI Complex Area	B
3-2	Site Plan	B
7-1	Storm Sewer System	B
7-2	Acid Drain System	B
7-3	KMCC Tenants - Southern Portion of Property	B
7-4	KMCC Tenants - Northern Portion of Property	B

I

der@environcorp.com, 29-Dec
18:09



CHAPTER 1.0
SUMMARY

1.0 EXECUTIVE SUMMARY

This Environmental Conditions Assessment (ECA) report was prepared for the Kerr-McGee Chemical Corporation (KMCC), Henderson, Nevada facility by Kleinfelder, Inc. to satisfy the requirements of a consent agreement with the Nevada Division of Environmental Protection (NDEP) (Reference K174). KMCC is one of six companies which entered into this consent agreement with the NDEP to conduct environmental studies to assess site specific environmental conditions which are the result of past and present industrial operations and waste disposal practices.

The six companies conducting the studies are current or former operators of facilities within an area known as the Basic Management, Inc. (BMI) complex. The BMI complex is located in unincorporated Clark County and is surrounded by the City of Henderson, Nevada.

The ECA process, to which this report applies, required the collection and review of extensive quantities of existing and historical documents and information. Documents were obtained from the KMCC Henderson, Nevada facility and approximately thirteen (13) non-company sources including the following:

- o NDEP;
- o Clark County Health District (Environmental Health);
- o Clark County Health District (Air Pollution Control Division);
- o Colorado River Commission;
- o U.S. Bureau of Reclamation (Boulder City, Nevada office);
- o Occupational Safety and Health Division - Nevada (Las Vegas, Nevada office);
- o Environmental Research Center (UNLV office);
- o University of Nevada Las Vegas Library;
- o Gibson Library;
- o U.S. EPA Region IX (San Francisco, California office);
- o Ecology and Environment, Inc. (San Francisco, California office);

- o Desert Research Institute (Las Vegas, Nevada office); and
- o U.S. EPA Environmental Monitoring Systems Laboratory (Las Vegas, Nevada office).

The organization of this draft report closely follows the format approved by the NDEP and presents the information developed from extensive document reviews, interviews and site tours or site reconnaissance of various portions specific to the KMCC facility. This draft report (Rev. 2.7) incorporates revisions based upon NDEP comments dated May 6, 1992. Recommendations have not been formulated at this time. Recommendations will be developed and incorporated at a later date and will be subject to NDEP review and comment.

Site use history from 1941 through current is presented in Section 3.0. This information includes a summary of U. S. Government activities, previous operating companies, and subsequent KMCC activities. The information presented regarding U.S. Government operations is also discussed in the common area study developed by Geraghty & Miller, Inc., which may contain additional materials unknown to KMCC at the time of their review. Local and regional hydrogeologic conditions are also summarized in this section.

Process descriptions for 13 chemical manufacturing activities identified as having occurred in the area now controlled by KMCC are provided in Section 4.0. These descriptions include processes both currently or formerly operated by KMCC and its predecessors.

Descriptions of thirty one (31) solid waste management units (SWMUs) are presented in Section 5.0. These SWMUs include areas on the KMCC site where wastes are known to have been managed by KMCC, other companies, or the U. S. Government.

Areas of known or suspected releases or spills are presented in Section 6.0. Twenty (20) such areas were identified.

Miscellaneous site activities are presented in Section 7.0. These include tenant activities and KMCC disposal to BMI complex common areas. Where overlap occurs concerning information presented in Sections 5.0 and 6.0, it is so referenced.

This report is subject to limitations as presented in Section 2.4 of this report. Unauthorized use or copying of this document is strictly prohibited.

I

der@environcorp.com, 29-Dec
18:09



CHAPTER 2.0
INTRODUCTION



2.0 INTRODUCTION

2.1 Requirements of the Consent Agreement

On April 25, 1991 six companies [including Kerr-McGee Chemical Corporation (KMCC)], which currently or formerly operated a facility at the Basic Management, Inc. (BMI) complex, entered into a Consent Agreement with the Nevada Division of Environmental Protection (NDEP) to complete individual site specific environmental studies (Reference K174). The purpose of the site specific studies is to assess environmental conditions which reflect past and present industrial operations and waste management activities of the individual companies.

The NDEP refers to this study as a "Phase I Environmental Conditions Assessment". The companies (including KMCC) are required to extend their "best efforts to determine, identify, evaluate or otherwise collect documentary information regarding":

- o all past and present industrial processes conducted and the solid waste, hazardous wastes and air pollutants generated by such industrial processes;*
- o all known or suspected, active or inactive, solid waste or hazardous waste treatment, storage, disposal or management units or areas, together with information regarding specific types, volumes and sources of waste placed in such units or areas, regardless of whether such units or areas were active on or after November 19, 1980;*
- o all known or suspected releases or spills (whether or not ongoing and irrespective of the date of occurrence) of any hazardous substance, regulated substance, hazardous constituent, pollutant or contaminant into the environment (as "environment" is defined in section 101(8) of CERCLA, 42 U.S.C. section 9601(8)), which, had any such release or spill occurred on or after the effective date of this Consent Agreement, would trigger the notification or reporting requirements of section 311 of the federal Clean Water Act, 33 U.S.C. section 1321, section 103 of CERCLA, 42 U.S.C. section 9603, sections 304 or 313 of the federal Emergency Planning and Community Right-To-Know Act, 42 U.S.C. sections 11004 or 11023, or regulations promulgated pursuant to section 9003 of RCRA, 42 U.S.C. section 6991b;*
- o where reportable quantities have not been established by the laws cited in Section 2(c) (iii) (Reference K174), all known or suspected releases or spills, whether or not on-going and irrespective of the date of occurrence, of a greater than de minimis quantity (as determined by the division) of such hazardous substance, regulated substance, hazardous constituent, pollutant or contaminant into the environment with respect*

to which any documentation exists in the control or possession of the Companies or Company, as applicable, or is otherwise identified during the Phase I environmental conditions assessments required by this Consent Agreement. A de minimis quantity determination with respect to a specific substance shall be made by the Division within 10 days following the submittal of a written request for such a determination;

- o all current and prior owners or operators of all or any portion of the relevant site or area, all corporate successors to such entities, and the specific dates of such ownership, operation and corporate succession;*
- o all records, data, findings, studies, investigation or inspection reports, or any other indications that the soil, surface water, groundwater or air at or in the vicinity of the BMI complex, any Individual Company Site, any BMI Common Area or any Off-Site Waste Management Area is, was, or may be contaminated with any hazardous substance, regulated substance, hazardous constituent, pollutant or contaminant as a result of any industrial or waste management operations associated with the BMI Complex; and*
- o all measures which have been, or are being, undertaken to monitor, characterize, prevent or mitigate the release into the environment from the relevant site or area of any hazardous substance, regulated substance, hazardous constituent, pollutant or contaminant, including associated design, construction, operation, and maintenance information.*

Pertinent data and information developed to address the above points are to be placed into a report and submitted to the NDEP for review and comments. The NDEP is to provide comments regarding the report and, if deemed necessary, conduct a Visual Site Inspection (VSI). The report is to be revised to address NDEP comments and results of any VSI. The NDEP is to notify KMCC as to whether sampling of certain identified areas is necessary. If sampling is not required, the report is final. In the event that sampling is required, a sampling plan is to be submitted to the NDEP for review and comment.

2.2 Purpose and Scope of the Environmental Conditions Assessment (ECA)

2.2.1 Purpose of the ECA

The purpose of the KMCC ECA is to document KMCC site specific environmental impacts resulting from past or present industrial activities.

The requirements set forth by the NDEP for the ECA generally incorporate elements of the RCRA Facility Assessment (RFA) guidance document. The ECA is comprised of the following three elements:

- o a description of site activities;
- o information on releases at the facility; and
- o information on solid waste management units (SWMUs) and other areas of potential concern for releases to various environmental media.

2.2.2 Scope of the ECA

The scope of the ECA includes activities to provide information on the environmental status of the site area controlled by KMCC. SWMUs and other areas of known or suspected releases, spills, discharges, and contamination are to be identified and assessed concerning their potential for environmental impact. This assessment is to include an evaluation of releases to the following media:

- o soils;
- o surface water;
- o groundwater; and
- o air (if the air release is depositional in nature).

The assessment conducted to date includes the following three stages:

- o a review of documents;
- o interviews; and
- o site visit or reconnaissance.

These three stages were conducted successively to build upon the information developed in each stage. During this evaluation, five general information categories consisting of unit characteristics, waste characteristics, contaminant migration pathways, evidence of release, and exposure potential were reviewed and evaluated (Reference Section 2.3.1 of this report).

Elements of the three stages outlined previously are further described below in the following paragraphs.

Preliminary Review (PR)

The Preliminary Review (PR) is a detailed review of existing site information. This information is collected through a review of KMCC facility files and a review of regulatory agency files.

Interviews

Interviews are conducted as needed to gain, as much as possible, first hand recollection of information. This information is evaluated to:

- o assess facility waste generation processes;
- o locate and assess SWMUs; and;
- o locate and assess other areas of known or suspected releases or spills.

Site Visit or Reconnaissance

Site visits are conducted to observe the operations and waste management practices and locations. This information is used in conjunction with the document review and interviews to develop a description of management activities and waste placement areas sufficient to make evaluations.

SWMUs and areas of known or suspected releases are visited and observations recorded. Photographs may be collected to document the status of SWMUs and other areas of interest.

2.3 Technical Approach to the ECA Process

A workplan, dated June 28, 1991, was prepared by Kleinfelder and submitted to the NDEP in accordance with the consent agreement. The NDEP reviewed the workplan and indicated that the workplan was approved contingent upon inclusion of a list of amendments and clarifying statement (Reference K182). The approved revised workplan outlined the technical approach (methodology) to be followed during preparation of this report (Reference K181). The following paragraphs provide a summary of the ECA methodology.

2.3.1 Preliminary Review (PR)

The Preliminary Review (PR) conducted for this project included three primary components: (1) a document inventory, (2) interviews, and (3) site visits.

Document Inventory

The document inventory process was conducted by Kleinfelder, Kerr-McGee, and Geraghty & Miller, Inc. employees. Reports, documents, and records from company and non-company sources that addressed waste generation and management activities were copied and catalogued. Kleinfelder was provided access to KMCC files relevant to those activities. The reviewed documents included information on the industrial processes, chemicals produced, waste materials, waste disposal practices, remediation programs, and tenants.

Pertinent information was also obtained from several NDEP identified non-company sources. The NDEP and Geraghty & Miller, Inc. contacted each of these proposed information sources for access to their files/records. Kleinfelder and/or Kerr-McGee employees obtained information from the following sources:

- o Clark County Health District (Environmental Health);
- o Clark County Health District (Air Pollution Control Division);
- o Colorado River Commission;
- o U.S. Bureau of Reclamation (Boulder City, Nevada office);
- o Occupational Safety and Health Division - Nevada (Las Vegas, Nevada office); and
- o Environmental Research Center (UNLV office).
- o U.S. EPA Region IX (San Francisco, California office); and
- o Ecology and Environment, Inc. (San Francisco, California office).

Geraghty & Miller, Inc. coordinated the visits to non-company sources permitting file access. Geraghty & Miller, Inc. also conducted a review of the NDEP files, copied and catalogued by company, and shipped these file copies to the KMCC facility. Kleinfelder employees subsequently reviewed the KMCC portion of the NDEP files.

Additional information was also obtained from other sources not specifically identified by the NDEP. These sources included the UNLV Library, Las Vegas, Nevada and the Gibson Library, Henderson, Nevada. Timet and Chemstar also provided relevant copies of documents found during their file review at some of these sources.

Geraghty & Miller, Inc. initiated a "Freedom of Information Act" request to the U.S. EPA Region IX to gain access to U.S. EPA files and their contractor's (Ecology and Environment) files. Documents and information provided to Geraghty & Miller, Inc. by the Desert Research Institute (Las Vegas, Nevada office) and the U.S. EPA Environmental Monitoring Systems Laboratory (Las Vegas, Nevada office) were subsequently distributed to Kleinfelder and KMCC.

Interviews

Interviews were conducted throughout the PR process in an attempt to fill data gaps and augment details of process activities and associated waste generation and disposal. These interviews were conducted during file reviews, site reconnaissance trips, or site tours of the manufacturing processes.

Site Visits

Several site visits were conducted during the ECA process. These visits were termed facility tours or reconnaissance trips.

Tours of the KMCC facility manufacturing process areas were conducted with the KMCC personnel to gain information on the process operations. Information obtained during these tours was used to understand the industrial process and provide background for document review and report preparation.

Site reconnaissance (SR) trips focused on SWMUs, areas of known or suspected releases or spills, and areas where tenant activities have been conducted. Kleinfelder was accompanied by KMCC personnel during the SRs. Visual and verbal information obtained during the SR trips was recorded and used to supplement the information obtained from various documents. The SR information typically included design features, operating procedures, physical condition of the area, visual evidence of releases, and possible migration pathways. Either hand written notes or an audio dictation system was used to record the information for use during report preparation.

Major Review Factors

The five general categories of information reviewed and evaluated during the PR were:

- o Unit Characteristics;
 - type of unit
 - design features
 - past/present operating procedures
 - period of operation
 - age of unit
 - location of unit
 - physical conditions
 - method of unit closure (if closed)
- o Waste Characteristics;
 - type of waste placed in unit
 - physical and chemical characteristics
 - migration and dispersal characteristics
- o Migration Pathways;
 - geological setting
 - hydrogeological setting
 - atmospheric conditions
 - topographic characteristics
- o Evidence of Release;
 - prior inspection reports
 - citizen complaints
 - monitoring data
 - visual evidence
 - physical evidence
 - sampling data
- o Exposure Potential
 - proximity of affected population
 - proximity of sensitive environments
 - migration potential

2.3.2 Agency Actions After Review of the ECA

Visual Site Inspection (VSI)

The NDEP may conduct a VSI, if necessary, after they have reviewed the ECA Report. Any VSIs will be conducted with representatives from the NDEP, KMCC, and Kleinfelder.

Sampling Visit (SV)

The NDEP will notify KMCC if sampling will be required after they have reviewed the ECA Report.

A sampling plan will be prepared and submitted to the NDEP for review and comment if sampling is required as part of the ECA. Sampling and analyses will be conducted as required by the NDEP. The approved sampling plan will be used as a guide for the sampling process.

2.4 Limitations

The following limitations cover this report and appendices in their entirety.

The scope of work for this report is to provide a description of the environmental conditions, as of the date of the work, resulting from past and present activities at the Kerr-McGee Chemical Corporation (KMCC) Henderson, Nevada Site. The scope of this assessment was limited to a qualitative evaluation of information based on the level of effort contained in the consent agreement between KMCC and the State of Nevada, Division of Environmental Protection (NDEP) dated April 25, 1991. The information for this study was obtained from KMCC documents, documents provided by various other sources including several regulatory agencies, interviews, and visual observations made during site visits. This assessment did not include soil, surface water or groundwater sampling.

A detailed review of documentary information was completed during development of this report. This evaluation did not extend to the issue of data quality. Due to the volume of information reviewed, Kleinfelder has not made any independent evaluation of the quality of data used as a basis for this report. Because the information has been generated by different sources over various time periods, it is expected that the data quality varies. For the purposes of this report, however, Kleinfelder has assumed that all data are of equal quality unless otherwise specifically discussed. These data are presented in a narrative that has essentially been organized in the format recommended and approved by the NDEP.

This report is one of seven (7) reports subject to an Environmental Conditions Assessment (ECA) of the BMI Complex. As such, these reports should be reviewed collectively and not used singularly.

The Consent Agreement requires a thorough records review for each Company comprising the BMI Complex, and does not envision or require extensive interviews of current or former employees. As such, those interviews conducted with current employees, were to supplement, with personal knowledge, the facts and circumstances illuminated by the records. Therefore, as a document based almost entirely on the review of historical and public records, this report does not and cannot be represented to contain all potentially relevant information, nor can it be said with certainty that all facts, figures or data presented in this report will, upon future review or scrutiny, be determined to be correct, whether due to error or subsequently discovered information.

KMCC and Kleinfelder conclude that this report represents their best efforts under the circumstances, and taken as a whole, represents the most extensive presentation of information ever assembled regarding the KMCC Henderson, Nevada facility. Moreover, (and recognizing the limitations of this ECA as set forth above) KMCC and Kleinfelder have no current actual knowledge of what may later constitute material misstatements or omissions in this document. Based on the foregoing, KMCC and Kleinfelder reserves the right to subsequently dispute or correct any description, data, or other information presented in this report.

Also, it must be recognized that this report has been prepared for purposes of facilitating the NDEPs assessment of environmental conditions relating to the KMCC site. In preparing this report, KMCC and Kleinfelder interpreted or analyzed information which was often unclear, inconsistent, or incomplete in favor of promoting the public health and environmental quality objectives of the NDEP. Accordingly, this report should be considered in light of these objectives and should not be utilized for any purposes or in other contexts other than the purposes and context for which it was prepared.

This report is intended for sole and explicit use by KMCC, the NDEP, and Kleinfelder, Inc. This report is copyrighted and may be used only by KMCC, the NDEP, and Kleinfelder, Inc. for the purpose stated. Unauthorized use or copying of this document is strictly prohibited. Any party other than KMCC, the NDEP, or Kleinfelder, Inc. who wishes to use this report shall notify KMCC of such intended use. Non-compliance with this copyright requirement will release Kleinfelder, Inc. and KMCC from any liability resulting from the use of this report by any unauthorized party.

Kleinfelder performed this assessment in accordance with generally accepted professional standards of care that existed at the time of this study, in accordance with the current regulatory framework, and in accordance with a work plan dated June 28, 1991 which was reviewed and approved by KMCC and NDEP. Professional judgments leading to any conclusions or recommendations were made based upon the information of source documents provided to us, interviews, and limited site reconnaissance. Kleinfelder does not warrant the accuracy of any of the documents or information on which this report is based.

I

der@environcorp.com, 29-Dec-18:09



CHAPTER 3.0
BACKGROUND



3.0 FACILITY BACKGROUND INFORMATION

3.1 Site History and Overview

3.1.1 General

The Kerr-McGee Chemical Corporation (KMCC) Site is part of the Basic Management Incorporated (BMI) complex. The BMI complex is located in an unincorporated portion of Clark County, Nevada and is completely surrounded by the City of Henderson, Nevada. Originally sited and operated by the United States Government as a magnesium production facility, the BMI complex operated from August 31, 1942 until November 15, 1944 to support the war effort. A portion of the complex was then leased from the U.S. Government by Western Electrochemical Company (WECCO) in 1945. By August 1, 1952, WECCO had purchased various portions of the complex. In 1955, WECCO merged with American Potash and Chemical Company (AP & CC) who operated the site through 1967. In 1962, AP & CC purchased the current ammonium perchlorate plant, sodium perchlorate plant, and 1/2 of the sodium chlorate plant from the U.S. Government. KMCC purchased AP & CC in 1967 and gained control of the property. Table 3.1.1 lists the previous operating entities at the KMCC site (Reference K037, K170, UL001, K262). An operating entity, as used herein, applies to anyone who controlled any portion that now comprises KMCC's segment of the BMI complex. This term is used to distinguish these entities from lessees and tenants.

TABLE 3.1.1

LIST OF PREVIOUS OPERATING ENTITIES AT KMCC SITE

<u>Entity</u>	<u>Operating Years</u>
U.S. Government	1941 to 1962*
WECCO	1945 to 1955
AP & CC	1955 to 1967
KMCC	1967 to Present

(Reference K037, UL001)

Note*: Portions of the U.S. Government operations were transferred to WECCO in 1945 but did not include the aforementioned ammonium perchlorate, sodium perchlorate, and 1/2 of the sodium chlorate plants. These areas were transferred later to AP & CC in 1962.

The original BMI complex was developed for the purpose of producing metallic magnesium for use by the military in World War II. The Defense Plant Corporation (DPC), acting for the U. S. Government, signed a contract with Basic Magnesium Incorporated on July 5, 1941 to construct and operate a magnesium plant. A site was selected between Las Vegas, Nevada and Boulder Dam since the plant needed considerable amounts of power and water (Reference N011). Additionally, this site was selected because a large magnesium ore deposit was within a reasonable distance and an ample supply of salt was procurable at an economical cost (Reference UL013).

Ground breaking for the magnesium plant began on September 15, 1941. On August 31, 1942, the switch was closed placing into operation the first set of electrolytic cells. Six weeks later, the first magnesium ingots were shipped to defense plants in Los Angeles, California for production of airplane parts. Later shipments were sent to airplane factories throughout the United States. All shipments of magnesium ingots occurred by rail and by the time the plant closed on November 15, 1944, roughly 166,322,700 pounds of marketable, refined, or alloyed magnesium ingots had been produced (Reference UL001).

The last production unit (Unit 10) was completed on May 14, 1943. On July 31, 1943, the last switch was closed placing into operation the tenth set of electrolytic cells. On November 15, 1944, the magnesium production portion of the plant was closed after 807 days of continuous operation. However, the supporting electrolytic chlorine and caustic soda portions of the plant remained in operation and in May 1945 were leased to Stauffer Chemical Corporation (Reference UL001, N011).

After the magnesium plant closed on November 15, 1944, the Reconstruction Finance Corporation (RFC) assumed control of the plant from the DPC. The RFC attempted to lease portions of the plant to various tenants. During this time, lease arrangements were made with several companies including Stauffer Chemical Corporation and WECCO. In October 1946, the RFC relinquished custody of the plant to the War Assets Administration (WAA) for liquidation (Reference N011, UL001).

During the next few years, several initiatives were taken to save the plant as a permanent industrial site. On March 27, 1947, the Governor of Nevada signed a bill authorizing the Colorado River Commission (CRC) to act on behalf of the State of

Nevada and negotiate with the U.S. government for purchase of the plant. A letter of intent dated March 17, 1948 and a supplemental letter of March 19, 1948 laid the foundation for CRC's purchase of the plant from the WAA. A letter from the WAA dated March 31, 1948 indicated the purchase terms had been accepted. On June 3, 1949, the BMI holdings were transferred to the CRC (the State of Nevada) by way of a quitclaim deed (Reference N001, N011, UL001, K262).

During the time that the CRC was negotiating with the federal government, a meeting between WAA, CRC, and State of Nevada representatives was held in Henderson, Nevada to discuss management of the property. An agreement was reached to leave the facility in the possession of the State of Nevada. However, a new organization was formed to manage the properties. This organization, Basic Management, Incorporated (BMI) was formed by appointing representatives of each of the primary resident companies. By 1951, the power distribution utilities and facilities common to all the users of the plant were purchased by BMI. The ownership of the main electrical substations was retained by the federal government and are currently managed by the Western Area Power Administration (WAPA) (Reference N001, N011, UL001, "Living Map" in BMI office).

The U. S. Government site facilities which later came under control of KMCC include the following (Reference K164, N009, N011):

- o six metal processing unit buildings (Units 1 through 6) and the attached chlorination buildings, rectifier buildings, motor generator buildings and bridges;
- o a flux plant;
- o peat storage areas;
- o an area with a salt storage building, pulverizer building, tunnel kiln building, rotary kiln building, pellet storage building, and magnesite silos;
- o various other buildings and open storage area; and
- o an area occupied by approximately two and one-fifth of the original four "Trade Effluent" disposal ponds. These on-site ponds were used for management of liquid waste generated by the U.S. Government operations.

Some of these original facilities remain (such as units 1 through 6) and have been renovated and modernized. Other original facilities (such as the peat storage buildings) have been removed and only foundations remain. Still other original facilities (such as the flux plant) have been replaced with newer structures.

3.1.2 U.S. Government Activities

The U.S. Government operated the BMI complex for the production of magnesium metal between August 31, 1942 and November 15, 1944. Magnesium oxide was delivered to the BMI complex from Gabbs, Nevada and stored in several large silos awaiting use (Reference UL001).

The production of magnesium metal began in the proportioning plant with the mixing of raw materials in rotary mixers. The raw materials included magnesia, magnesite, peat, coal, and salts. This mixture was then fed to several pug mills where concentrated magnesium chloride solution was mixed with the dry mass to form a dough-like material. This material was then sent to the preparation building (Reference UL012).

Two similar materials were produced in the preparation plant. The dough-like material from the pug mills was processed and dried to form either pellets or blocks for feed to the chlorinators. This process included the use of a tunnel kiln and rotary kilns (Reference UL012).

The magnesium process occurred in ten large identical buildings (Units 1 through 10). Each unit included a chlorination building, electrolytic cell building, rectifier building, motor generator building, and bridges that connected the units. The pelletized and chunked material formed at the preparation plant was transported to the metal units. The pellets were then charged to chlorinators (furnaces) where they were reacted with chlorine gas at 850°C to form anhydrous magnesium chloride. The molten anhydrous magnesium chloride was collected from the bottom of the chlorinator and fed to an electrolytic cell where unrefined magnesium metal and chlorine were produced. The chlorine was recycled to the chlorinators and the unrefined magnesium metal "cell metal" was cast into ingots (pigs) in a separate area and sent for refining (Reference N001, N009, UL001, UL012).

The impure magnesium pigs were heated, melted, and refined. The refined molten metal was then poured into molds using an automatically controlled tilting frame, crane, and furnace pot. The furnace pot was transferred to a cleaning room to empty the sludge/impurities (Reference UL012).

The concentrated magnesium chloride solution added in the pug mill to prepare the "dough" was prepared by reacting raw materials with chlorination and refining wastes. Exhaust gases from the chlorinators were scrubbed in primary and secondary wash towers. The scrubber solution contained hydrochloric acid and magnesium chloride. This solution was neutralized with calcined magnesite, concentrated by evaporation, and stored ready for use (Reference UL012).

The chlorine and caustic solutions used in the process were manufactured in a plant sited on the western portion of the BMI complex. Once the magnesium production process was well established, only make up chlorine from the plant was needed as the majority was recovered from the electrolysis in the metal units (Reference UL012).

Each of the ten "metal" units contained 88 electrolytic cells. During operation, each cell produced the following daily (Reference N009).

- o 390 pounds of "cell metal";
- o 96 pounds of waste cell melt;
- o 70 pounds of cell mud; and
- o 1,000 pounds of chlorine gas.

Acid and caustic wastes were also generated as a part of the process. Portions of both of these wastes were used in the production of concentrated magnesium chloride solution for use in the pug mill (Reference UL012). However, some quantity of acid and waste caustic liquor was discharged to evaporation ponds (Reference UL020). Initially this waste was discharged to the four on-site "Trade Effluent" disposal ponds and later to the upper and lower BMI ponds. (Reference UL020).

Detailed records describing the quantities of waste produced and the location(s) for disposal during the U.S. Government era were not found during this study. The disposal methods and location of any unrecycled waste cell melt and cell mud materials is not known. From the materials on hand, the following summary of waste management practice was pieced together:

- o Liquid wastes were discharged to four "Trade Effluent" disposal ponds (two and one-fifth of which are present on KMCC property) (Reference K164). The liquid wastes were comprised of acid effluent and waste caustic liquor (Reference UL020).
- o Wastewater originating from site processes was discharged to a storm sewer system which emptied into unlined drainage ditches (the Beta Ditch). The unlined drainage ditches (the Beta Ditch) routed wastewater to a system of unlined ponds currently known as the upper and lower BMI ponds (Reference K164, UL020).
- o Solid materials (possibly wastes) were placed in an open area due south of the "Trade Effluent" disposal ponds and north of the caustic settling ponds. The material was placed in an area which currently is owned by KMCC, Pioneer, and BMI (Reference K164).

3.1.3 Other Previous Lessees On KMCC Property

Between November, 1944 and June, 1949 several companies leased portions of the BMI complex from either the RFC or the WAA. The actual locations leased and operations conducted by these companies are not well documented. The following descriptions are for lessees which are known to have occupied property which later became part of the KMCC site. This information is not based on title reviews or legal descriptions, but rather from a review of the cited publicly available documentation, and is included solely for the purpose of compiling information on industrial processes and wastes generated.

Valite Industries, Inc.

Valite Industries, Inc. (Valite) was listed in an April 21, 1947 Las Vegas Review-Journal article as a new lessee (Reference GL002). Valite proposed to lease the south half of the flux plant including one-half of the crusher building, one-half of the conveyor ramp, one-half of the proportioning bins, the barrel storage building, and one room in the central laboratory (Reference N008). The laboratory was located west of Unit 1 which is currently Pioneer property. The remaining leased facilities were located north of Units 5 and 6 in the current KMCC manganese leach plant area (Reference N009). Valite operation involved building materials and plastics (Reference GL002). Further documentary information that would provide more detail was not found.

Hardesty Chemical Company

Hardesty Chemical Company (Hardesty) signed a letter of intent on December 10, 1945 for a five-year lease (Reference N009). Hardesty began operations on September 1, 1946 and occupied eight buildings including Unit 2 (Reference N008, N007). By early 1948, Hardesty was purchased by AMECCO Chemicals, Inc. (Reference UL002). Hardesty (and/or AMECCO) produced synthetic detergents, various chlorinated organics, chemicals for fireproofing paints, insecticides, and chlorinated solvents (Reference UL002). Chlorobenzol was also produced (Reference N008). Products listed for proposed production included muriatic acid, synthetic hydrochloric acid, monochlorobenzene, paradichlorobenzene, orthodichlorobenzene, and DDT (Reference N008, N009). Further documentary information that would provide more production process detail was not found.

3.1.4 Previous Operating Companies

Western Electrochemical Company

Western Electrochemical Company (WECCO) was the first privately owned company to operate on the future KMCC site within the original BMI complex after magnesium production stopped on November 15, 1944. WECCO operated the site from approximately 1945 through 1955. During this time the original BMI was renamed Basic Management Incorporated. WECCO produced chemicals including Sodium Chlorate, Potassium Chlorate, Potassium Perchlorate, Ammonium Perchlorate, and Manganese Dioxide (Reference K037, N001).

In May, 1945 WECCO entered into a contract with the Defense Plant Corporation (DPC) for the production of perchlorates at the Henderson industrial facility. The plant was designed and operated for the Department of the Navy. One of the ten existing "Units" was rehabilitated for the production of perchlorates to support the World War II effort. The conversion involved the removal of magnesium cell lines and installation of Schumacher type chlorate and perchlorate cells along with other related equipment. By June or July 1945, the plant was operating even before the conversion was complete. However, the plant only operated for approximately one month as production was stopped the day after V-J day. A clean-up program was initiated and the equipment was placed in stand-by condition (Reference N001, N007, N011).

Six months later, WECCO negotiated a lease with Reconstruction Financing Corporation (RFC), which had dissolved DPC. WECCO resumed operations in February 1946 for the production of chlorates and perchlorates for the commercial market. The areas included in this lease comprised (Reference N001, N011):

- o Unit 4;
- o the salt storage area;
- o the acid neutralization area; and
- o miscellaneous office and storage areas.

In 1950, WECCO expanded its operations to include production of manganese dioxide. A large pilot plant was constructed in November, 1950 and placed in operation in February 1951. In May 1953, a ten ton per day plant was completed to replace the pilot plant for the production of synthetic, battery-grade electrolytic manganese dioxide. In June, 1953, WECCO started production of high purity manganese metal on a developmental basis (Reference N001).

During WECCO's tenure, the entire Basic Magnesium Project (BMP) was turned over from the RFC to the Colorado River Commission (CRC) for management and disposition. On May 20, 1952, a bill of sale recorded the purchase of portions of the BMP complex by WECCO from the CRC (Reference N001). The bill of sale included the following inventory of the property purchased by WECCO (Reference N011):

- o Units 1 through 6
- o the preparation area;
- o the neutralization plant area;
- o the flux plant area; and
- o numerous various storage buildings, shops, substations, etc.

A list of products, estimated amounts produced and years of production for WECCO are summarized in Table 3.1.2.

TABLE 3.1.2
PRODUCT SUMMARY FOR WECCO

<u>Product</u>	<u>Estimated Amounts Produced</u> (tons)	<u>Years Produced</u>
Sodium Chlorate	33,153	1945 to 1955
Potassium Chlorate	12,599	1945 to 1955
Potassium Perchlorate	10,402	1945 to 1955
Ammonium Perchlorate	7,142	1951 to 1955
Manganese Dioxide	6,226	1951 to 1955

(Reference K037, K176, K179)

WECCO disposed an estimated 104,000 cubic feet of chlorate process wastes (i.e. graphite, calcium carbonate and calcium sulfate) in the Upper and Lower BMI ponds between 1945 and 1955 (Reference K037). WECCO also disposed perchlorate process solids in the BMI ponds during the years 1951 to 1955. Perchlorate solids were not measurable in the liquid waste streams (because they were soluble), therefore, reliable numbers for the amount of solid waste disposed to the BMI ponds are not available (Reference K037). The specific pond(s) that received these wastes (upper or lower BMI ponds) are not documented (Reference K056).

WECCO disposed an estimated 95,000 cubic feet of manganese dioxide process wastes (i.e., manganese ore, heavy metal sulfides, diatomaceous earth and paraffin wax) in the on-site "company ponds" between 1951 and 1955 (Reference K037). The term on-site "company ponds" refers to the leach beds located beneath the current manganese tailings pile area. Table 3.1.3 provides a summary of the waste information for WECCO.

TABLE 3.1.3

SUMMARY OF WASTE INFORMATION FOR WECCO

<u>Process Waste</u>	<u>Years</u>	<u>Volume cu. ft.</u>	<u>Disposal Site</u>
Chlorates	1945-1955	104,000	BMI Ponds
Manganese Dioxide	1951-1955	95,000	Company Ponds ⁽¹⁾
Perchlorate Solids	1951-1955	Not Measurable	BMI Ponds

(Reference K037)

⁽¹⁾Company Ponds refers to leach beds on the KMCC site.

American Potash and Chemical Corporation

American Potash and Chemical Corporation (AP & CC) operated the site from 1955 to 1967 (Reference K037). AP & CC acquired the site in 1955 through a merger agreement with WECCO (Reference K262). AP & CC produced similar chemicals and wastes to those produced by WECCO (Reference K037). Production accounting procedures use 1955 as the end date of WECCO production and 1956 as the start of AP&CC production. Table 3.1.4 provides a summary of the chemicals produced and Table 3.1.5 provides a summary of the waste produced by AP & CC.

TABLE 3.1.4

PRODUCT SUMMARY FOR AP & CC

<u>Product</u>	<u>Estimated Amount Produced (tons)</u>	<u>Years Produced</u>
Sodium Chlorate	149,419	1956 to 1967
Potassium Chlorate	23,046	1956 to 1967
Potassium Perchlorate	3,142	1956 to 1967
Ammonium Perchlorate	83,240	1956 to 1967
Manganese Dioxide	41,432	1956 to 1967

(Reference K037, K176)

AP & CC disposed an estimated 162,000 cubic feet of chlorate process wastes in the BMI ponds during the years 1956 to 1967 (Reference K037). AP & CC also disposed perchlorate process solids in the BMI ponds during the years 1956 to 1967. Perchlorate solids were not measurable in the liquid waste streams (because they were soluble), therefore, reliable numbers for the amount of solid waste disposed to the BMI ponds are not available (Reference K037). The specific pond(s) that received these wastes (upper or lower BMI ponds) are not documented (Reference K056).

AP & CC disposed an estimated 426,000 cubic feet of manganese dioxide process wastes in the on-site "company ponds" during the years 1956 to 1967 (Reference K037).

TABLE 3.1.5

SUMMARY OF WASTE INFORMATION FOR AP & CC

<u>Process Waste</u>	<u>Years</u>	<u>Volume Cu.Ft.</u>	<u>Disposal Site</u>
Chlorates	1956 - 1967	162,000	BMI Ponds
Manganese Dioxide	1956 - 1967	426,000	Company Ponds ⁽¹⁾
Perchlorate Solids	1956 - 1967	Not Measurable	BMI Ponds

(Reference K037)

Note:

⁽¹⁾Company Ponds refers to leach beds on the KMCC site.

3.1.5 Kerr-McGee Chemical Corporation Activities

Kerr-McGee Chemical Corporation (KMCC) is the current site owner/operator and obtained the facility from AP & CC in 1967 through a merger. Plate 3-1 depicts the current KMCC property boundary (Reference "Living Map" in BMI office).

KMCC has produced a variety of products at the Henderson, Nevada facility since 1967. Besides manufacturing the same chemical products that WECCO and AP & CC produced at the facility, KMCC introduced the following six new chemical products to their production processes: sodium perchlorate, magnesium perchlorate, boron

trichloride, boron tribromide, elemental boron, and a sodium chlorate based bleaching agent called Tumbleaf Defoliant®. Sodium perchlorate was produced by WECCO and AP&CC, as an intermediate product, whereas KMCC marketed this product commercially. Table 3.1.6 lists these products, estimated amounts produced, and years of production.

TABLE 3.1.6
PRODUCTS, ESTIMATED AMOUNTS, AND YEARS PRODUCED
AT THE KMCC FACILITY

<u>Product</u> ⁽¹⁾	<u>Estimated Amounts Produced (tons)</u>	<u>Years Produced</u> ⁽²⁾
Sodium Chlorate	374,066	1967 to current
Sodium Perchlorate	14,819	1968 to current
Potassium Chlorate	5,103	1967 to 1975
Potassium Perchlorate	8,762	1967 to 1982
Ammonium Perchlorate	214,776	1967 to current
Manganese Dioxide	219,470	1967 to current
Magnesium Perchlorate	744	1969 to 1976
Boron Trichloride	4,346	1973 to current
Boron Tribromide	62	1973 to current
Elemental Boron	112	1972 to current
Tumbleaf Defoliant® (Reference K037, K095, K176)	3,798	1975 to 1985

Notes:

- (1) Other inorganic chemicals were also produced at various times for a limited time period on an experimental basis (Reference K037). These included bench or pilot tests which produced small quantities of chemicals similar to those used or produced at the facility.
- (2) Current indicates the time this report was being prepared; fall of 1991.

Descriptions of KMCC's chemical processes, waste streams and waste management practices for the above listed products are provided in Sections 4.0 through 7.0 of this report.

Production and recovery of chlorates (sodium chlorate and potassium chlorate) has occurred historically in Units 3, 4, and 5 (Reference Plate 3-2). The sodium chlorate

process was renovated in 1989 and the new process began production in January 1990. The new electrolytic and recovery processes occur solely in Unit 3 (Reference Sections 4.1 and 4.2 of this report).

The production of perchlorates (excluding ammonium perchlorate) has occurred historically in Units 4 and 5 (Reference Plate 3-2). Currently, sodium perchlorate is produced within the eastern portion of Unit 5 (Reference Section 4.4, 4.5, and 4.6 of this report).

Production of ammonium perchlorate (AP) on-site was initiated by WECCO in 1951. The AP process occurs in several buildings located in the central portion of the facility (Reference Plate 3-2; Section 4.7 of this report).

The beneficiation of manganese dioxide ore to produce high purity, battery active manganese dioxide occurs on-site in two areas. The ore is prepared and leached in the Manganese Dioxide Leach Plant area north of Units 5 and 6. The resulting manganese sulfate solution is fed to electrolytic cells in Unit 6 (Reference Plate 3-2; Sections 4.8 and 4.9 of this report).

Production of boron products was initiated by KMCC in 1972. Elemental boron, boron trichloride, and boron tribromide are produced in Unit 5 (Reference Plate 3-2; Sections 4.10, 4.11, and 4.12 of this report).

Tables 3.1.7 (below) and C-1 (Appendix C) provide summaries of waste information for KMCC and this facility.

TABLE 3.1.7

SUMMARY OF WASTE INFORMATION FOR KMCC

<u>Waste</u>	<u>Years Produced</u>	<u>Disposal Site</u>
Chlorate Wastes	1968 to 1974	BMI Ponds
Perchlorate Wastes	1967 to 1974	BMI Ponds
Liquid Wastes	1968 to 1976	BMI Ponds
Elemental Boron Wastes	1972 to 1976	BMI Ponds
Perchlorate Wastes	1975 to Present	Lined Ponds(1)
Liquid Wastes	1975 to Present	Lined Ponds(1)
Elemental Boron Wastes	1976 to Present	Lined Ponds(1)
Chlorate Wastes	1975 to 1980	BMI Dump
Boron Compounds Wastes	1972 to 1979	BMI Dump
Boron Compounds Wastes	1979 to Present	Sanitary Landfill(2)
Chlorate Wastes	1980 to 1983	On-Site H.W. Landfill(3)
Chlorate Wastes	1983 to Present	Commercial H.W. Landfill(4)
Manganese Dioxide Wastes	1967 to 1975	On-Site Leachbeds
Manganese Dioxide Wastes	1975 to Present	On-Site Nonhazardous Pile

Notes:

(1) Lined ponds are the single- and double-lined surface impoundments constructed on the KMCC site.

(2) Sanitary Landfill refers to the sanitary landfill operated by Silver State Disposal Company. Material disposed is nonhazardous solid industrial waste.

(3) On-site H.W. Landfill refers to the hazardous waste landfill located on the KMCC site. This landfill was closed in accordance with applicable regulations.

(4) Commercial H.W. Landfill refers to the hazardous waste landfill in Beatty, Nevada currently operated by U.S. Ecology, Inc.

(Reference K037, K039, K095)

In January 1976, KMCC achieved "zero discharge" status for industrial wastewater (Reference K347). From 1971 to 1976, KMCC achieved this zero discharge status by altering operations and constructing lined ponds (surface impoundments) on their site for recycle and evaporation.

Between 1971 and 1976, while working towards achieving "zero discharge" status, KMCC undertook several steps including the following:

- o modification of the manganese dioxide process in 1975 through installation of filters to provide a semi-dry filter cake waste to replace the former sluiced (slurried) waste (Reference K003, K013, UE030);
- o modification of the sodium chlorate process in 1975 through installation of additional filters to provide a semi-dry filter cake waste to replace the former sluiced (slurried) waste (Reference K003, K013, UE030);
- o modification of the ammonium perchlorate process. The process modifications were completed by May 1, 1974 (Reference K003, K013, UE030);
- o construction of on-site lined surface impoundments (SIs) for management of chlorate process liquids and ammonium perchlorate (AP) process liquids. SI S-1 was completed in October 1974 for management of chlorate process liquids. Three AP SIs were completed by May 8, 1974 for management of AP liquids (Reference K003, K013, UE030); and
- o construction of on-site lined SIs for management of various process liquids and wastes. SI C-1 was completed by December 1974 for management of nonhazardous wastes including cooling tower liquids. SIs P-1 and P-2 were constructed in May through September 1972 for management of potassium bearing process fluids (Reference K003, K013, UE030).

Additional modifications to both process and waste management practices continue through the present time. These modifications include closure of outdated SIs, construction of several on-site lined process specific SIs, and initiation of procedures to reduce potential environmental impacts.

3.2 Site and Geologic Conditions

3.2.1 Location and Climate

Location

The BMI complex (excluding the upper and lower BMI ponds) is surrounded by the community of Henderson, Nevada. The KMCC site is located within the central portion of the BMI complex. Henderson, and the facility, are built upon an alluvial fan approximately mid distance between Boulder Dam and downtown Las Vegas, Nevada. Las Vegas, Nevada is approximately 10 miles northwest of the BMI complex.

Climate

The Las Vegas Valley climate is arid to semi-arid. This area is one of the driest and warmest areas in the United States. The climate consists of hot summers, mild winters, a moderately wide diurnal temperature range, and wide fluctuations in seasonal rainfall. Cloudless skies are normal (Reference UB003, K170).

The Las Vegas Valley receives an average annual precipitation of 4.62 inches. Precipitation generally occurs during two clearly defined rainy seasons. During the winter months (December through March) cyclonic storms usually release the most rainfall. These frontal storms produce low intensity rainfall over large areas. Some frontal storms also occur during the summer, but most rainfall during the summer and early fall results from violent thundershowers which form quickly and deliver their rain in sudden showers, causing occasional local floods and erosion. Over one-third of the annual average rainfall at Las Vegas' McCarran Airport (2,162 feet elevation) occurs as short term, high intensity rainfall during these violent thunderstorms. Most documented floods in Las Vegas occur during July and August (Reference K167, OT002).

Temperatures occasionally rise to 120^o F in the lower valleys in summer, but may fall below 20^o F on the higher mountains in winter. The mean daily maximum temperature at Las Vegas' McCarran Airport ranges from 55.4^o F in January to 113^o F in July. The mean daily minimum temperature for the same months ranges from 32.9^o F to 76.1^o F. (Reference K167, OT004).

The "potential annual evaporation" from lake and reservoir surfaces ranges from 60 to 82 inches, or roughly 15 to 20 times the annual precipitation (Reference K167). The high evaporation is the result of high annual temperatures, low precipitation, frequent wind, and commonly low humidity (Reference UB003, K170).

The average relative humidity is approximately 20 percent. Less than 10 percent relative humidity is common during the summer months (Reference UB003).

Winds frequently blow from the southwest or northwest and are strongly influenced by the mountain topography. The mean wind velocity is 9 miles per hour (mph), but

velocities in excess of 50 mph are experienced several times a year during the passage of major frontal systems. During high winds, ground surface material becomes airborne, and the blowing dust and sand may travel many miles (Reference UB003).

3.2.2 Regional Geology

The Las Vegas Valley is a prominent topographic depression trending northwest and extending approximately 55 miles from Railroad Pass to near Indian Springs. Frenchman Mountain and Sunrise Mountain bound the Valley to the east. The Las Vegas Range, Sheep Range and Desert Range bound the Valley to the north. The Spring Mountains bound the Valley to the west and the McCullough Range and River Mountains bound the Valley to the south and southeast respectively. The mountains/mountain ranges bounding the east, north and west sides of the Valley consist primarily of Paleozoic and Mesozoic sedimentary rocks (limestones, sandstones, siltstones, and fanglomerates). The mountains on the south and southeast side of the Valley consist primarily of Tertiary volcanic rocks (basalts, rhyolites, andesites and related rocks) that lie directly on Precambrian metamorphic and granitic rocks (Reference OT003).

The Las Vegas Valley is filled with Quaternary and Tertiary aged unconsolidated deposits. The valley floor consists of alluvial and playa deposits surrounded by more steeply sloping alluvial aprons derived from erosion of the surrounding mountains. Generally, the deposits grade finer with increasing distance from the source area and with decreasing elevation. The alluvial and playa deposits can be several hundred feet thick in several areas within the Las Vegas Valley (Reference OT001).

The structure within the Quaternary and Tertiary aged basin fill is characterized by a series of generally north-south trending step-like topographic features known as "compaction faults" [faulting attributed to differential compaction of deposits (i.e. a process in which highly compressible fine-grained deposits consolidate, or compact, to a greater degree than less compressible coarse-grained deposits)] (Reference OT003).

3.2.3 Regional Hydrogeology

Historically, nearly all of the groundwater supply in the Las Vegas Valley has come from the "Valley-fill Groundwater Reservoir". The reservoir consists of the Muddy

Creek Formation and all of the relatively unconsolidated deposits that comprise the valley fill (Reference OT003).

The aquifer system was originally subdivided into two major components by Maxey and Jameson (1948): (1) the near-surface aquifer and (2) the confined water aquifer (Reference OT003). The confined water was further divided into three zones - shallow, middle, and deep. The confined water aquifer, as defined by Maxey and Jameson, is recognizable only in the central part of the Basin and does not allow for correlation to other parts of the Basin. Harrill therefore, prefers to use the terms: (1) "Near-Surface" reservoir and (2) "Principal Aquifers", where the "Principal Aquifers" includes the original subdivisions by Maxey and Jameson as well as other recognized zones (Reference K167).

The Near-Surface Reservoir (Maxey and Jameson's Near-Surface Aquifer) is the first water encountered upon drilling. It occurs under both unconfined (water table) and confined (artesian) conditions. Under natural pre-pumping conditions, the water in this reservoir was derived mostly from upward leakage from the primary artesian system. Infiltration of sanitation process, industrial process, and irrigation waters have now become the main source of recharge to the near-surface reservoir. Discharge is almost entirely through evapo-transpiration (Reference OT003).

The principal aquifers underlie the near-surface reservoir and have confined and semi-confined groundwater conditions. In the central portions of the Las Vegas Valley, the Principal Aquifers can be subdivided into Maxey and Jameson's three zones: (1) Shallow Zone; (2) Middle Zone; and (3) Deep Zone (Reference OT003).

The shallow zone is entered immediately below the Near-Surface Reservoir at depths of as much as 300 feet, and it is underlain by the "blue-clay horizon" (Reference OT003).

The middle zone lies between the blue-clay horizon and the base of the Plio-Pleistocene (Tertiary-Quaternary) basin fill sequence. Together, with the shallow zone, these two zones are the main sources of groundwater within the Las Vegas Valley (Reference OT003).

The deep zone (believed to be in the Muddy Creek Formation) lies between 700 and 1000 feet below ground surface. Throughout most of the basin, this zone does not

readily yield groundwater due to low transmissivity values. However, a few deep wells have tapped gravelly horizons and as a result, the zone has been termed the Deep Zone (Reference OT003).

Aquifers in the Las Vegas Valley are separated by thick sequences of fine grained deposits which exhibit a low permeability. Interconnection between these aquifers in the valley occurs through upward leakage along fault zones and through semi-confining layers (Reference K167).

Recharge to the Near-Surface Reservoir (aquifer) is generally through over irrigation and other forms of artificial water use to the land surface as well as "upward leakage" through fault zones and semi-confining layers (Reference OT003).

Recharge to the Principal Reservoirs (Aquifers) is primarily through the artesian flow system and run-off from precipitation occurring in the surrounding mountains which infiltrates the alluvium along the valley margins. Locally some secondary recharge may be derived from downward percolation of excess surface water (Reference OT003, K167).

3.2.4 Site-Specific Geologic, Hydrogeologic, Topographic and Drainage Conditions

Geology of the KMCC Site

The KMCC facility rests on alluvial sediments derived from erosion of the McCullough range that form northwest sloping coalescing alluvial fans. The site specific geological conditions of the KMCC site are similar to the regional geologic conditions (Reference K170). The geologic units include the upper 200 feet of the Muddy Creek formation and overlying alluvial fan sediments (Reference K167, K170).

The Pleistocene Muddy Creek formation underlies the surficial alluvial deposits at the KMCC site. This formation primarily consists of brown to reddish-brown silty clay and clayey silt. In addition, thin discontinuous lenses of fine sand and silt may be present locally (Reference K170, K167).

The alluvial fan sediments were deposited on the older erosional surface of the Muddy Creek formation during infrequent flood runoff periods. The thickness of these

deposits varies locally depending upon the erosional configuration of the Muddy Creek surface. Generally, these alluvial deposits thicken from south to north beneath the facility. These deposits are thickest over the erosional channels and thinnest over intervening interfluvial areas. The thickness of the alluvial deposits range from approximately 19 to 62 feet beneath the KMCC facility (Reference K167, K170).

The lithology of alluvial deposits consists primarily of a reddish-brown, heterogeneous, poorly-sorted mixture of sand and gravel with lesser amounts of silt and clay. Boulders and cobbles are common. Due to their mode of deposition, no distinct beds or units are continuous over the area. Distinct layers are only present in the form of gravel beds cemented with caliche (calcium carbonate) in the northwest corner of the site (Reference K170).

A major feature of these alluvial deposits is the stream deposited sands and gravels that were laid down within the old channels developed on the surface of the Muddy Creek formation. These deposits conform to the old channel boundaries which were characteristically linear and narrow in configuration. These "channel fill" deposits are typically uniform sands and gravels and show higher permeability than the adjacent poorly-sorted alluvial deposits. Once the old erosional channels were filled with the "channel fill" deposits, they were encased by the poorly sorted alluvial fan deposits. The importance of these "channel fill" deposits is that they greatly affect and control the occurrence and movement of groundwater in this portion of the Las Vegas Valley (Reference K167, K170).

A distinct formation change between the Muddy Creek formation and alluvial sediments does not exist. A 5-foot thick transitional zone typically occurs above the Muddy Creek formation where small white clayey silt lenses are interbedded with sand and gravel (Reference K167, K170).

Hydrogeology of the KMCC Site

The following subsection is a summary of information presented in Kerr-McGee's hydrogeological investigation of 1985 (Reference K167).

The site is located near the southern edge of the Las Vegas Valley. Geologic units important to the site include the upper portions of the Muddy Creek formation and the

overlying alluvial fan deposits. These geologic units comprise the Near-Surface Aquifer. The deep Principal Aquifer is several hundreds of feet deep and is separated from the Near-Surface Aquifer by fine grained deposits of low permeability. Therefore, the potential impact to the deep Principal Aquifer by near surface discharges is unlikely. As a result, the hydrogeology of the deep Principal Aquifer is not discussed within this report. The following is a summary of the hydrogeological environments of the two geologic units of the Near-Surface Aquifer, the alluvial fan deposits and the upper portions of the Muddy Creek formation.

Alluvial fan deposits are present over the entire site and unconformably overlie the Muddy Creek Formation. The alluvial fan deposits are unsaturated (do not contain groundwater) in the southern and west-central portion of the site. In this area, the unconfined groundwater lies within the Muddy Creek Formation. Conversely, the alluvial fan deposits are saturated in the northern and east-central portion of the site.

Generally, the larger zones of saturation occur over buried "channel fill" deposits developed on top of the Muddy Creek Formation. The smaller zones of saturation occur over the interfluvial areas that separate these old channel systems. Typically, these "channel fill" deposits (which are found in the old buried stream channels developed on top of the Muddy Creek Formation) are much more permeable than the deposits in the interfluvial areas that separate the buried channel systems.

Groundwater within the Near-Surface Aquifer (alluvial fan deposits) generally exists beneath the northern and east-central portions of the site at depths ranging between less than 5 feet below ground surface (near the northeast corner of the site) to approximately 35 feet below ground surface (near the southern and west-central portions of the site).

The on-site groundwater velocity of the alluvial fan deposits was calculated to be between 0.5 and 16 feet/day. A groundwater velocity of 16 feet/day occurred within the "channel fill" deposits. The lowest groundwater velocity of 0.5 feet/day was from an interfluvial area.

The transmissivity of the on-site alluvial deposits ranged from 231 gallons per day per foot (gpd/ft) in an interfluvial area to 23,786 gpd/ft in "channel fill" deposits.

The hydraulic conductivity varied from 50 gpd/ft² to 1,496 gpd/ft² in interfluvial and "channel fill" deposits respectively. The storage coefficient averages 0.053.

Because of the variability in alluvial fan deposition and saturated thickness of the alluvial deposits, no specific or average permeability has been used to describe the on-site groundwater flow in these deposits.

Water table fluctuations are noted in several wells completed within the alluvial deposits at the site. Maximum water level fluctuations in any one well from the period June, 1983 to June, 1985 varied from 1.54 to 3.08 feet and averaged 2.16 feet. These groundwater fluctuations are the result of seasonal climatic changes with groundwater at its lowest level during the spring months and at its highest level during the fall.

Groundwater occurs within the upper portions of the Muddy Creek Formation (Near-Surface Aquifer). Groundwater is typically found within the Muddy Creek silts and clays over the west-central portions of the site at depths ranging between 35 and 55 feet below ground surface. In general, groundwater moves in a north-northwesterly direction beneath the site and changes to a north-northeasterly direction, toward the Las Vegas Wash, near the northern end of the site.

An average flow velocity of 0.53 feet/day was calculated for groundwater flowing through the Muddy Creek Formation. The relatively high value was attributed to thin sand and silt stringers which account for most of the Muddy Creek's permeability.

Transmissivity values in the Muddy Creek Formation varied from 45.2 to 180 gpd/ft and averaged 89.2 gpd/ft.

Permeability tests at four on-site wells completed in the Muddy Creek formation indicate that the Muddy Creek formation has a horizontal permeability or hydraulic conductivity ranging from 6.5 gpd/ft² to 54.5 gpd/ft² with an average of 29.1 gpd/ft². The average hydraulic gradient over areas where the groundwater occurs within the Muddy Creek formation is 0.027 feet/foot. The average storage coefficient was 0.053.

Water level data collected between June, 1983 to June, 1985 from selected wells within the Muddy Creek formation show small groundwater fluctuations ranging between 1.2 and 1.68 feet and appear to be a result of seasonal climatic changes. The groundwater is typically at its lowest levels during the spring months and at its highest levels during early to late fall.

Topography of the KMCC site

The KMCC Henderson Facility is located at the south-eastern edge of the Las Vegas Valley. The facility rests upon alluvial fan sediments originating from Black Mountain within the McCullough Range located south of the site. This alluvial fan slopes gradually to the north-northwest beneath the site. (Reference K167).

Topographic features of the site and site area are shown on Plates 3-1 and 3-2. The elevation ranges from approximately 1,875 feet above mean sea level (msl) in the southeastern portion of the site to approximately 1,675 feet msl in the northeastern portion of the site (Reference K161, K167).

The topography varies gradually throughout the majority of the southern and northern portions of the site. The central portion of the facility displays the most significant topographic changes. These changes are primarily associated with man-made features including drainages, surface impoundments, dikes, and the manganese tailings pile (Reference K161, SR, August 19 & 20, 1991).

Stormwater Drainage of the KMCC Site

Stormwater drainage of the KMCC site is accomplished by natural and manmade features. The manmade features include various subsurface drains and surface ditches.

Stormwater drainage from the KMCC site is accomplished by two primary drainage ditches. The Beta Ditch crosses the central portion of the site and flows to the east onto Timet property. The second unnamed drainage originates near the Beta Ditch and crosses the northern portion of the site (Reference K164, K167).

The Beta Ditch is more fully described in Sections 5.20 of this report. Historically, the Beta Ditch received flows from the storm sewer system (including process effluent) and

acid drain system. After approximately January 1976, when KMCC became a "zero industrial wastewater discharge" facility, subsequent flows to the Beta Ditch were routinely from stormwater and once through cooling water.

The unnamed drainage, mentioned above, historically lead to the Las Vegas Wash (Reference K164). Prior to 1971, some wastes may have been transmitted through this drainage, however, this drainage was designed for stormwater management. By 1979, this drainage emptied into an off-site gravel pit near the northwestern site boundary (Reference K164). This drainage currently conveys stormwater run-off (Reference K167).

Other drainage systems installed on-site by the U.S. Government during facility construction were primarily related to industrial and sanitary waste management. These systems included (Reference UL020):

- o sanitary sewer;
- o storm sewer;
- o acid drains;
- o caustic drains;
- o absorber tower drains; and
- o recirculating drains.

The sanitary sewer services the portion of the facility which was constructed by the U.S. Government (Reference K160). The sanitary sewer drains to a sewage disposal plant currently operated by the City of Henderson. This drain system was constructed of vitrified clay sewer pipe (Reference K160)

The storm sewer system is more fully described in Section 7.3 of this report. The storm sewer system was installed to collect stormwater and convey this to the Beta Ditch (Reference K178). This system was also used by various companies between 1945 and 1975 to convey various wastes to the Beta Ditch and on to the BMI ponds.

The acid drain system is more fully described in Section 7.4 of this report. This system was originally designed to convey acid effluent to a neutralization plant (Reference K163). This system was also used by various companies between 1945 and 1975 to convey wastes to the Beta Ditch and on to the BMI ponds.

The function of the caustic drain system is not well documented. This system conveyed excess cell liquor from "cell buildings" to two caustic evaporation ponds through 8-inch cast iron pipes (Reference UL020). The location of the drain system is not known. The caustic ponds are located on property currently owned by Pioneer (Reference K178; "Living Map" in BMI office).

The absorber tower drain system was installed after the magnesium plant was operating. This system was used to remove the last traces of chlorine and hydrochloric acid from the chlorinator waste gases previously scrubbed by the primary and secondary chlorinator wash towers. Waste caustic liquor from the chlorine plant was used for this purpose. After passing through the absorber tower, this waste was conveyed through vitrified clay pipe drains to the "Trade Effluent" settling ponds at the same point where the acid drains discharged (Reference UL020).

A recirculating drain system serviced the chlorine plant and discharged to cooling tower in that portion of the complex. A second recirculating drain system serviced the rest of the facility and discharged to the main cooling tower. Cooling water from bearings and heat exchangers was conveyed through this system. The system was comprised of cast iron, steel, and vitrified clay pipe (Reference UL020).

der@environcorp.com, 29-Dec-18:10

CHAPTER 4.0
PROCESS

4.0 INDUSTRIAL PROCESSES AND WASTES GENERATED

Industrial Process Overview

The industrial activities at the KMCC Henderson site are separated into three production categories:

- o chlorate/perchlorate based compounds;
- o electrolytic manganese dioxide; and
- o boron and halogenated boron products.

The following paragraphs provide a brief overview of these three categories. Details of the process flow and waste stream characterization for individual processes follow in Subsections 4.1 through 4.13. There are three types of air pollutant emission sources of a depositional nature associated with KMCC's current processes. These particulate emission sources are related to the manufacture of manganese dioxide, ammonium perchlorate, and sodium chlorate. These sources were permitted in 1962 via the CCHD/APCD permit programs and include pollution control devices.

Off-specification products from the various processes were redissolved and/or reprocessed to the maximum extent possible (Reference K357).

Chlorate/Perchlorate Based Compounds

Sodium chloride, common table salt, is dissolved in water to form a brine and is then converted to sodium chlorate in an electrolytic cell. The sodium chlorate is purified and separated from the brine solution by crystallization. The sodium chlorate is either bagged as a finished product, or employed as a precursor for the on-site production of other chlorates and perchlorates. From 1975 to 1985, sodium chlorate was also blended with dry materials and marketed as Tumbleaf Defoliant® (Reference K117, K176, K253).

The bulk of the sodium chlorate product remains at the facility and is redissolved forming the feedstock to make sodium perchlorate in another electrolytic cell circuit. Most of the sodium perchlorate is used in the production of ammonium perchlorate (Reference K117, K176, K253).

From 1945 to 1975, some sodium chlorate was reacted with potassium chloride to form potassium chlorate. The same equipment was also used to make potassium perchlorate from sodium perchlorate (Reference K176, K253).

From 1969 to 1976, some ammonium perchlorate was also reacted with magnesium carbonate to make magnesium perchlorate (Reference K176, K255). These perchlorates were crystallized and sold as a solid.

Electrolytic Manganese Dioxide

This operation processes manganese dioxide ore to produce a high purity manganese dioxide for use in dry cell batteries. The ore is leached to form a manganese sulfate solution which is then converted to manganese dioxide in an electrolytic cell (Reference K117, K253).

Elemental Boron and Halogenated Boron Products

Magnesium metal is oxidized with anhydrous boric acid in an argon atmosphere to produce elemental boron. Boron carbide is heated in an induction reactor in the presence of either chlorine or bromine gas to form boron trichloride or boron tribromide (Reference K117, K257, K258).

4.1 Sodium Chlorate Process

4.1.1 General Description

Sodium chlorate has been a main chemical produced at the KMCC Henderson, Nevada site. It is a precursor for the production of potassium chlorate and all the perchlorates that have been produced at the site. Sodium chlorate production was started in 1945, when approximately 1,300 Schumacher electrolytic cells were installed at the Henderson site. The facility had a maximum production rate of approximately 32,000 tons of sodium chlorate per year.

In 1989, the Schumacher cells were shut down and replaced with 24 "Krebs" electrolytic cells. The Krebs cells have a maximum production rate of approximately 14,000 tons of sodium chlorate per year (Reference K117, K253, K357).

Table 4.1.1 summarizes the sodium chlorate production from 1951 through 1990.

TABLE 4.1.1
SODIUM CHLORATE PRODUCTION - TONS
 (Reference K176)

<u>Year</u>	<u>NaClO₃ Recovered</u>	<u>NaClO₃ Finished</u>
1951	16,326	7,671
1952	18,172	7,678
1953	18,545	8,574
1954	16,528	9,230
1955	18,228	12,136
1956	24,644	16,989
1957	24,346	19,141
1958	24,232	14,228
1959	27,232	13,814
1960	20,228	12,731
1961	25,597	10,776
1962	23,110	11,562
1963	20,088	6,965
1964	17,881	7,986
1965	12,938	7,003
1966	24,246	16,088
1967	24,130	13,783
1968	24,806	17,608
1969	30,366	23,438
1970	29,515	20,904
1971	29,021	24,247
1972	29,023	20,112
1973	32,074	23,726
1974	31,757	24,862
1975	29,805	24,131
1976	30,219	23,823
1977	30,538	22,382
1978	27,984	21,312
1979	27,927	18,364
1980	27,892	19,009
1981	28,305	19,162
1982	26,004	16,066
1983	21,436	10,969
1984	22,906	8,192
1985	21,665	5,849
1986	23,401	6,658
1987	22,757	6,368
1988	15,799	1,537
1989	9,112	1,016
1990	13,764	548

Note: The production amount between 1945 and 1950 is not known. "Recovered" production is the total amount produced. "Finished" production is product ready for off-site sales. The recovered product that is not "Finished" is used as feed for other processes at the Henderson facility.

The Schumacher electrolytic cells were located in Units 4 and 5. The new Krebs electrolytic cells, which started production in January, 1990, were installed in Unit 3.

The sodium chlorate recovery equipment has historically been located in Unit 3 where sodium chlorate and impurities are separated from the mother liquor; hence waste streams also originate at that point.

Because the Krebs cells required a more pure mother liquor, the recovery and purification systems were modified accordingly.

4.1.2 Raw Materials Used

The following raw materials are used in the production of sodium chlorate (Reference K037, K253, CA017):

- o sodium chloride (NaCl);
- o sodium dichromate (Na₂Cr₂O₇);
- o hydrochloric acid (HCl);
- o sodium hydroxide (NaOH);
- o urea (CO(NH₂)₂);
- o water;
- o soda ash (Na₂CO₃);
- o strontium carbonate;
- o silica (anti-caking agent);
- o diatomaceous earth;
- o filter aid; and
- o graphite (historically).

4.1.3 Production Process Flow Description

Process Description for Schumacher Cells

The chlorate process consists of the electrolytic cells, external holding tanks, chlorate

recovery system, and brine dissolving system. The electrolytic cells are fed from large brine holding tanks and the cell overflow is returned and cycled. The chemical reactions involved in the electrolysis results in the conversion of sodium chloride to sodium chlorate. A bleed stream of cell liquor is fed to the sodium chlorate recovery process. Salt-saturated mother liquor from the recovery process, hydrochloric acid (to control pH), and sodium dichromate (a necessary constituent in the electrolyte) are added to the sodium chlorate recovery process (Reference K253).

Solution is continuously bled from the electrolytic cell recirculating system to the chlorate recovery process. Figure 4.1.1 depicts the sodium chlorate recovery operation. The solution is treated with urea and caustic, and air-agitated. After preparation and treatment, the chlorate solution is pumped to recovery where sodium chloride (salt) is added to depress the solubility of sodium chlorate. Sodium chlorate is crystallized from solution by cooling (Reference K253).

The sodium chlorate crystals are centrifuged, washed, and dried. The finished product is conveyed to storage for external use, or conveyed to a dissolving tank for internal plant use in the manufacture of other chemicals, e.g. perchlorates (Reference K253).

A description of the process begins with the mother liquor from the chlorate crystallizer passing to dissolving tanks for salt addition. Water is added only to replace the amount consumed by the electrolysis reaction. From the salt dissolvers, the salt-saturated solution is pumped to the cell recirculation system with intermittent treatment made for calcium removal (Reference K253).

Before the electrolytic cell product can be sent to the chlorate recovery process, various treatments must be performed. Residual hypochlorite must be decomposed by treatment with urea and the solution made alkaline to minimize equipment corrosion throughout the recovery system. The reaction of urea with sodium hypochlorite is represented as:



Filter aid is added to assist removal of particulate carbon from electrode decrepitation. At certain intervals, depending on concentration, sulfate impurity is also removed by

precipitation and pressure leaf filtration. These handling operations are all done prior to pumping the cell effluent to the recovery system salt dissolvers (Reference K253).

The salt used in the sodium chlorate salt dissolving process is of high purity to greatly reduce the need for solution purification treatment (Reference K253).

The salt is conveyed from hopper cars to silo storage, from which it is fed to the salt dissolvers as needed. Three agitator vessels in series serve as the dissolving system (Reference K253).

The filtered salt saturated solution is combined in the crystallizer feed tank with a recycle slurry stream returning from the second stage crystallizer operation. The resulting solution or slurry is fed to crystallizers (Reference K253).

Crystallization of sodium chlorate takes place in two crystallizers in series flow. The crystal slurry in each stage is cooled by circulation through an external shell-and-tube heat exchanger. Cooling in the first stage heat exchanger utilizes cold mother liquor where cooling in the second stage heat exchanger is by direct ammonia expansion on the shell side of the heat exchanger. The crystals are removed by cyclones and advanced to a centrifuge for washing. The centrifuge wash water returns to the process system as make-up water (Reference K253).

The saturated salt filtration system mentioned earlier functions to remove carbon during normal cycle and solid calcium sulfate during treatment cycle. The filter cake is sluiced to a cone bottom recovery tank where the mud is washed and settled to recover chlorate. The chlorate solution and washwater is brought back into process, and the washed mud is discharged as a waste (Reference K253).

Sulfate impurity is controlled in the recovery system by reaction with calcium chloride:



After the sulfate is removed, the excess calcium must be controlled. Removal of calcium is done by precipitation of calcium carbonate through addition of soda ash, according to the reaction:

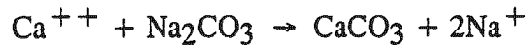

The above reaction is carried out by adding the solid soda ash and filter aid to a surge tank which is then pumped to a pressure-leaf filter where the solids are removed. The solids are discharged from the filter to a sludge tank from which the major portion of the sodium chlorate values are recovered from the sludge before it is discharged to the storm water system as filter slurry. The filtered mother liquor is returned to the salt dissolvers (Reference K253).

Very little water enters the circuit directly without being used first to recover chlorate values from the various washing operations within the production area. Only the water that is lost by electrolysis in the cells needs to be replaced (Reference K253).

The washed sodium chlorate crystals from the centrifuge are fed to a dryer. The drying of crystals is presently accomplished by flow of hot air. Exhaust dust from the dryer is passed through a wet-type dust collector (CCHD/APCD Permit Number A09506) (Reference K372). The water used to remove and dissolve the sodium chlorate dust is recycled to the crystal centrifuge (Reference K253).

Dry sodium chlorate crystals discharge from the hot end of the rotary dryer and are conveyed to storage. The finished product may be stored, conveyed directly to handling for shipment, or used directly for solution preparation for internal plant operations in the production of other chlorates or perchlorates (Reference K253).

Off-specification sodium chlorate was redissolved and returned to the production flow for reprocessing (Reference K357).

Process Description for Krebs Cell

Sodium chlorate production using Krebs electrolytic cells started in January 1990. The Krebs electrolytic cells use titanium anodes rather than sacrificial graphite anodes as were used with the Schumacher cells. Although the chemical reactions are the same, there is a change in the sequencing of the process (Reference K259, K357).

The fresh brine is combined with the mother liquor before the mother liquor is sent to the electrolytic cells. Figure 4.1.2 is a flow diagram for the Krebs electrolytic cell process.

The brine dissolving step for both the Schumacher and Krebs systems is similar but extra purification steps have been added for the Krebs system. A portion of mother liquor from the crystallizer is treated with CaCl_2 to generate a sulfate precipitate cake before it is used to dissolve sodium chloride. The process is reconfigured slightly allowing the brine to be filtered before it is combined with the mother liquor (Reference K357). The moist brine cake and dry sulfate cake are combined for management as a sodium chlorate filter cake.

Some of the major differences between the Schumacher and Krebs systems are in waste generation. The Krebs electrolytic cell waste does not contain graphite. Also, because most of the salt comes from the ammonium perchlorate plant, there is less impurity and, therefore, less waste generated per ton of chlorate produced.

As in the Shumaker process, off-specification sodium chlorate was redissolved and returned to the production flow for reprocessing (Reference K357).

Solutions from the sodium chlorate production process have been sent to the on-site ponds for management since early 1975 (Reference K031, K056, K117, K158A, UE030). A brief description of the ponds (surface impoundments) and associated process fluids and wastes follows.

Old P-2 Pond

This surface impoundment received three process streams from May of 1975 to April of 1990 from the sodium chlorate production process: 1) washdown water, 2) process area storm water, and 3) excess sodium chlorate solutions from process vessels containing too much liquid. These solutions consisted of sodium chlorate solution containing small amounts of hexavalent chromium (Reference K031, K037, K161, K170; SR, August 20, 1991). Old P-2 Pond is designated SWMU KMCC-010, and is discussed in Section 5.10.

P-3 Pond

From May 1978 to 1990 this surface impoundment received sodium chlorate solution containing small amounts of chromium from washdown activity in the process area,

process area storm water, and excess solution from process vessels containing too much liquid (Reference K031, K117, K158A).

New P-2 Pond

The new P-2 pond replaces the P-3 and old P-2 ponds described above. The process streams received by the New P-2 pond remained the same (Reference K158A).

4.1.4 Waste Stream Characterization

The physical characteristics of sodium chlorate production process effluent changed with the introduction of different process filters in February 1975 and the introduction of the new Krebs electrolytic cells in 1990. Therefore, the discussion of effluent is discussed for two periods; prior to 1990 and after 1990.

Waste Characteristics Prior to 1990

Sodium chlorate production process effluent from 1945 to February 1975 were generated from sluice discharging filters, process area washdown, and storm water. From February 1975 to 1990, process effluent were generated from the following steps: sparkler filter cakes, pressure leaf filter, filter aid, process washdown, and storm water (Reference K056, K117, K278, K253, UE030).

The first waste streams generated at the filters consisted of cakes containing chiefly diatomaceous earth with small amounts of carbon, Na_2CO_3 , CaSO_4 , NaCl , NaClO_3 , CaCO_3 , and 0.05 to 1.00 percent hexavalent chromium (Reference K037, K056, K219, K253, K278, CA017). From 1945 to 1974, these filter cake wastes were sluiced to the upper and lower BMI ponds (Reference K037, K056). Process modifications were completed by February 1975 replacing sluice discharging filters with filters that discharged a moist cake (Reference K056, UE030). Between early 1975 and February 1980, KMCC disposed of these solid wastes in the BMI landfill (Reference K037, K056). In February 1980 the BMI landfill was closed and KMCC then disposed of these wastes in an on-site hazardous waste landfill from February 1980 to January 1983 (Reference K056, K095, K108, K128, K130). The on-site hazardous waste landfill was closed in January 1983 (Reference K130, K138). From February 1983 to present, KMCC has disposed of this waste off-site in a U.S. Ecology disposal facility located in

Beatty, Nevada (Reference K095). The changes and modifications to the sodium chlorate production process reduced the quantity of waste generated, but the waste's chemical characterization remained generally unchanged until the 1990 introduction of the Krebs cell process.

Sodium dichromate was used in the old electrolytic process and in the new Krebs cell processes. The sodium dichromate supports the reaction of converting sodium chloride to sodium chlorate. Small amounts of sodium dichromate are added to the recycle water in order to maintain a certain concentration. The brine solution is filtered after the electrolytic cell process to remove sodium chloride crystals. This filter cake stream contains some hexavalent chromium entrained with the moisture (Reference K170, K253).

Scrap carbon (graphite anodes) from the sodium chlorate process was periodically sold to off-site companies (Reference K325).

Waste Characteristics after 1990

The Krebs electrolytic process started operation in January, 1990. Waste streams from this process are generated at the following filtration operations: mud filter, brine filter, polishing filter, and sulfate filter (Reference K259, K357).

The solids (cakes or muds) resulting from these process filtration steps are dewatered at SWMU KMCC-005 prior to storage at SWMU KMCC-006. These wastes consist chiefly of diatomaceous earth and containing small amounts of sodium chlorate, sodium carbonate, calcium sulfate, sodium chloride, hexavalent chromium and calcium carbonate, and (Reference K037, K278, CA017). These wastes do not contain carbon since graphite electrodes are not used in the Krebs electrolytic cells (Reference K259). The filtrate liquid is recycled to the process and the solids are shipped off-site for disposal at a U.S. Ecology disposal facility in Beatty, Nevada (Reference K179).

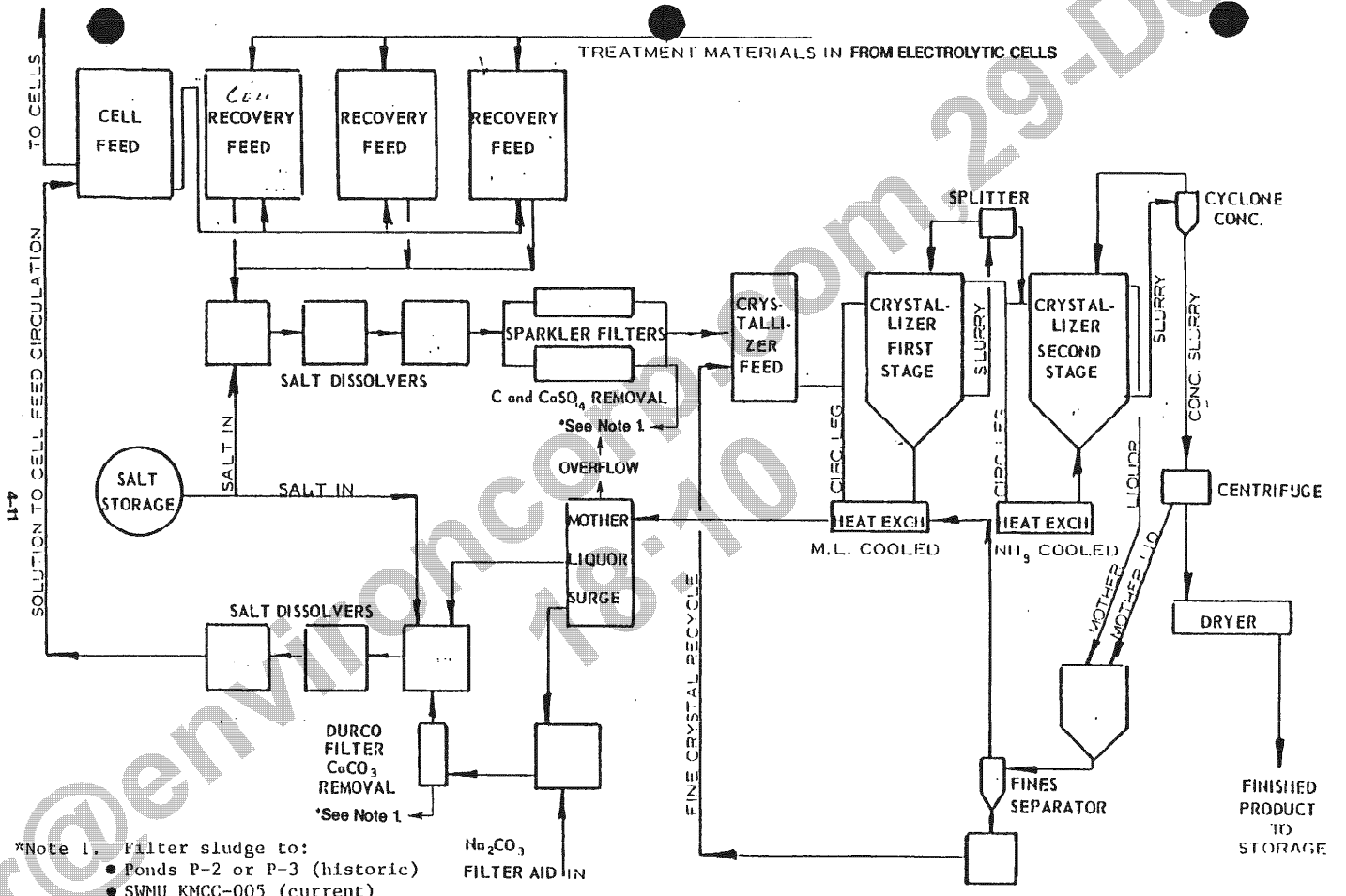

*Note 1. Filter sludge to:

- Ponds P-2 or P-3 (historic)
- SWNU KMCC-005 (current)

Modified after flow diagram provided by KMCC. Reference DOC. #K253; K117, K170.

31-135909-004

KMCC DR
04-0008501

L

A-12

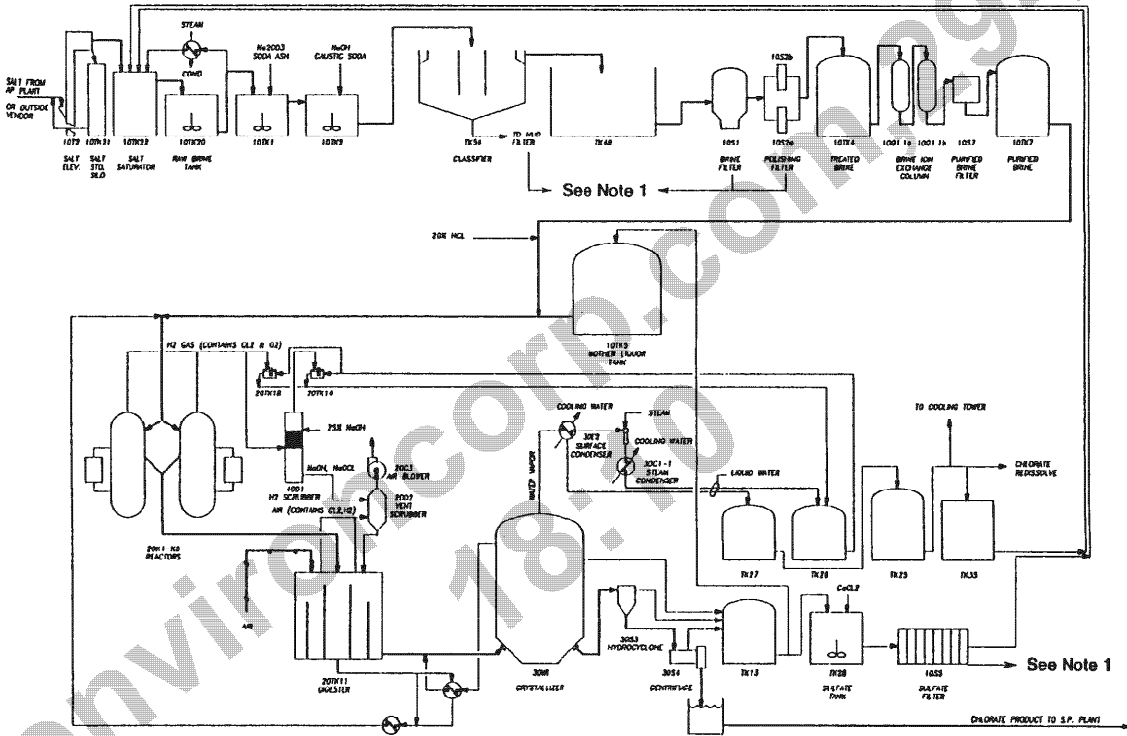

KERR-McGEE CHEMICAL CORP.		P.O. BOX 95 NEHEMBOLE, N.V. ROAD, OUST	ATE No.	JOB No.
APPROVED FOR CONSTRUCTION		DATE	DESIGN	DATE
SAFETY	BY	PROCESS	SCALE	DATE
ENVIRONMENTAL	DATE	PRODUCT	PROJ. NO.	DATE
OPERATIONAL	DATE	PLANT	SCALE	DATE
PRODUCTION	DATE	PLANT	SCALE	DATE
RELIABILITY	DATE	PLANT	SCALE	DATE

**SODIUM CHLORATE
PROCESS FLOW DIAGRAM**

Drawing No. **A-13-1-42**

Note 1. Filter sludge to SWMU KMCC-005.

Modified after flow diagram provided by KMCC. Reference DOC #K259; personal communication KMCC Environmental Engineer.

31-135909-004

KMC DR
04-0008502

4.2 Potassium Chlorate Process (Unit 4)

4.2.1 General Description

Potassium chlorate was produced at the KMCC Henderson site between 1945 and 1975 in Unit 4. Table 4.2.1 summarizes the amount of finished potassium chlorate produced between 1951 and 1975.

TABLE 4.2.1

POTASSIUM CHLORATE PRODUCTION - TONS
(Reference K176)

<u>Year</u>	<u>KClO₃</u>
1951	4,498
1952	2,798
1953	2,973
1954	2,330
1955	2,198
1956	2,211
1957	1,853
1958	2,132
1959	1,846
1960	2,077
1961	2,338
1962	1,582
1963	1,439
1964	1,468
1965	2,264
1966	1,638
1967	1,624
1968	1,528
1969	861
1970	271
1971	302
1972	216
1973	154
1974	137
1975	10

Note: The production amount between 1945 and 1950 is not known.

4.2.2 Raw Materials Used

The manufacture of potassium chlorate utilized sodium chlorate produced at the KMCC Henderson facility and potassium chloride as raw materials (Reference K037, K253).

4.2.3 Production Process Flow Description

Potassium chlorate was produced by KMCC and its predecessors between 1945 and 1975 by the double decomposition of sodium chlorate and potassium chloride. The reaction employed was:



The batch process is shown in Figure 4.2.1. Dry potassium chloride was mixed with water in a dissolving tank and heated. The hot potassium chloride solution was filtered and added to a crystallizer tank containing sodium chlorate solution. Crystallization of potassium chlorate occurred immediately upon mixing. The batch was cooled with ammonia cooled rotators and readied for recovery (Reference K253).

Potassium chlorate crystals were recovered from a slurry on a centrifuge and washed. The centrifuge mother liquor was discharged to the storm sewer and the Beta Ditch or to on-site ponds and represented a loss of KClO_3 , KCl , NaClO_3 , and NaCl (Reference K253).

Crystals from the centrifuge were re-slurried and separated again on a second centrifuge. The secondary centrifuge cake was fed to a counter-current, gas-fired rotary dryer and the dried product proceeded to storage. From storage the product was ground, screened, and packed to customer specification (Reference K253).

Fines were recovered from the dryer exhaust air stream in the wet scrubber (CCHD/APCD Permit Number A09506). Water was fed to the scrubber to dissolve the fines and the resulting solution was stored for potassium chloride dissolving. Spills and recoverable solution were also stored and used for potassium chloride dissolving (Reference K253). Off-specification product is redissolved and returned to the potassium chlorate production flow for reprocessing (Reference K357).

A synopsis of known on-site ponds used for management of process streams associated with the potassium chlorate production follows. For detailed discussions of these surface impoundments, refer to Section 5.0 of this report.

Lined surface impoundments S-1 and P-1 began receiving filter cake sludges and process vessel overflow solutions (occurring from upset conditions) from the time when the facility was in the process of achieving "zero industrial wastewater discharge" from 1972 to 1974 until the production of potassium chlorate ceased in 1975. Prior to the mid-1970s, these wastes were discharged to the upper or lower BMI ponds via the Beta Ditch (Reference K170, K179).

4.2.4 Waste Stream Characterization

Wastes generated from the potassium chlorate process included process solution in the form of mother liquor (extracted by a constant process bleed stream), and cake from filters. Between 1945 and 1974, this waste stream was disposed as part of the plant's wastewater which was discharged to the Beta Ditch and conveyed to the unlined BMI ponds (Reference K037, K056).

After use of the BMI ponds ceased, wastes from this process were discharged to the lined on-site S-1 or P-1 surface impoundments from 1974 to 1975 (Reference K037, K056). Waste streams from potassium chlorate production contained NaCl, KCl NaClO₃, and KClO₃ (Reference K037, K039).

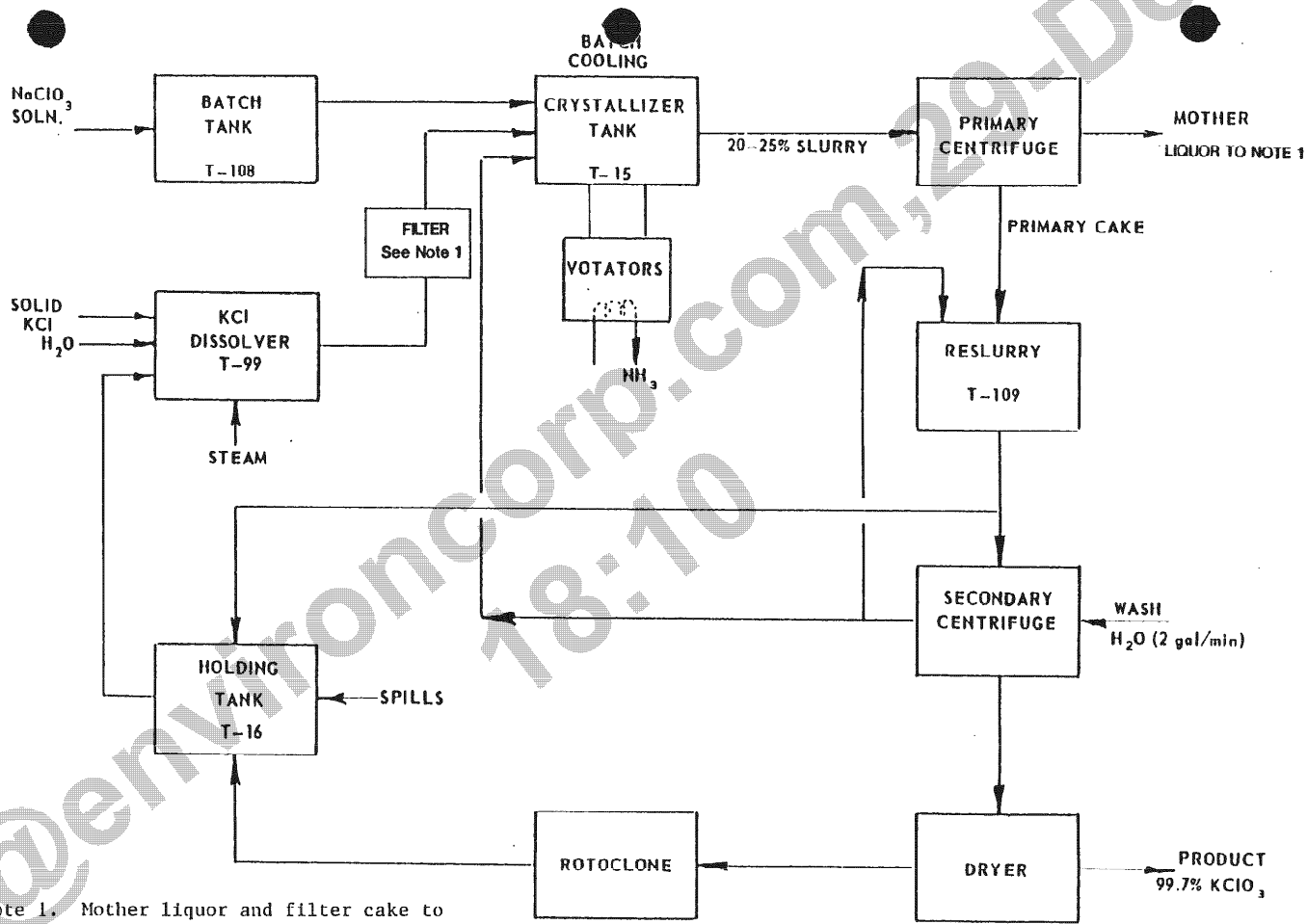

Note 1. Mother liquor and filter cake to Ponds S-1 and P-1 historically.

Modified after flow diagram provided by KMCC. Reference DOC #K253.

31-135909-004

KMC DR
 04-0008506

⊥

4.3 Tumbleaf Defoliant® Process (North of Unit 5)

4.3.1 General Description

Tumbleaf Defoliant® was a dry blended product that was produced at the KMCC Henderson, Nevada site between 1975 and 1985 in an area north of Unit 5 (Reference K357). This type of defoliant, typically used in the cotton industry, utilizes the bleaching action of sodium chlorate. Upon application, the sodium chlorate bleaches the leaves making them incapable of collecting sunlight thus causing the leaves to fall from the plant making harvesting of cotton easier. Table 4.3.1 summarizes production rates for Tumbleaf.

TABLE 4.3.1
TUMBLEAF PRODUCTION - TONS
(Reference K176)

<u>Year</u>	<u>Tumbleaf</u>
1975	384
1976	179
1977	290
1978	676
1979	211
1980	642
1981	523
1982	508
1983	(5)(*)
1984	248
1985	132

Note: (*) Negative number: accounting procedure to adjust finished product tonnage which is less than production figures indicate was manufactured over eight years of production.

4.3.2 Raw Materials Used

The following raw materials were used in the production of the Tumbleaf Defoliant® (Reference K256, CA017):

- o Na ClO₃ (Sodium Chlorate);

- o Na_2CO_3 (Soda Ash);
- o $\text{CO}(\text{NH}_2)_2$ (Urea); and
- o Sodium Alpha Olefin Sulfonate.

4.3.3 Production Process Flow Description

All the materials used in the production of Tumbleaf Defoliant® were dry granulated or flaked solids. The material was added to a dry blender in a prescribed ratio and blended until it was homogeneous (Reference K256).

4.3.4 Waste Stream Characterization

The process apparently did not produce a waste stream (Reference CA017).

4.4 Sodium Perchlorate Process (Unit 5)

4.4.1 General Description

Sodium perchlorate production at the KMCC Henderson, Nevada site started in approximately 1945 and was conducted in the east side of Unit 5.

Sodium perchlorate has been used chiefly as a feed for the ammonium perchlorate and potassium perchlorate processes at the facility. From 1968 until 1990, sodium perchlorate was also sold as a finished product. The amount of finished sodium perchlorate produced between 1968 and 1990 is summarized in Table 4.4.1.

TABLE 4.4.1
 SODIUM PERCHLORATE PRODUCTION - TONS
 (Reference K176)

<u>Year</u>	<u>NaClO₄ Finished</u>
1968	113
1969	71
1970	375
1971	142
1972	61
1973	75
1974	62
1975	41
1976	142
1977	416
1978	333
1979	804
1980	1,383
1981	1,567
1982	942
1983	841
1984	1,366
1985	1,878
1986	1,259
1987	1,061
1988	1,346
1989	262
1990	279

Note: Sodium perchlorate produced between 1945 and 1967 was consumed in the production of ammonium perchlorate and/or potassium perchlorate.

4.4.2 Raw Materials Used

The raw materials used in the electrolytic production of sodium perchlorate include the following (Reference K253, CA017):

- o sodium chlorate;
- o water;
- o hydrochloric acid;
- o soda ash;
- o cellulose filter aid;
- o diatomaceous earth; and
- o sodium dichromate.

4.4.3 Production Process Flow Description

The process equipment for the production of sodium perchlorate consists of electrolytic cells and external holding tanks. Figure 4.4.1 is a process block flow diagram depicting the sodium perchlorate production process. This is a batch process.

The sodium perchlorate is formed by the oxidation of sodium chlorate:



The anode is platinum and the electrolyte contains small quantities of sodium dichromate. The sodium dichromate is used to inhibit cathodic reduction of the chlorate or perchlorate (Reference K253).

Off-specification sodium perchlorate was redissolved and returned to the production flow for reprocessing (Reference K353).

From 1951 to prior to January 1976, some process liquids from the sodium perchlorate process were discharged to the BMI ponds via the Beta Ditch (Reference K037, K039, K056, K347). Lined SIs S-1 and P-1 were constructed between fall 1972 and spring 1974. They received these process liquids intermittently during the operation's

modification period between fall 1972 and January 1976. From January 1976 to 1983, these same process liquids were discharged to the lined on-site surface impoundments S-1 and P-1 (Reference K037, K039, K095, K124, K347). Section 5.0 of this report provides further descriptions on the S-1 and P-1 surface impoundments.

4.4.4 Waste Stream Characterization

Wastes and recyclable materials associated with the sodium perchlorate process consist of filter cakes and cell bottoms (Reference K278). The cell bottoms and filter cake material are washed to recover perchlorate prior to recycling for platinum recovery (derived from the anodes). The recyclable material contains diatomaceous earth, platinum, chromium, sodium chloride, sodium perchlorate, sodium carbonate, and calcium carbonate (Reference K275, K278).

The cell bottoms and filter cake material are from two different parts of the same process train. The platinum present in both sources is derived from the anodes in the sodium perchlorate cells. The cell bottoms contain platinum, chromium, sodium chloride, sodium perchlorate, sodium carbonate, and calcium carbonate. The filter cake, which results from filtering the process solution, contains the same constituents plus the diatomaceous earth (pre-coat) filter medium (Reference K275, K278).

In approximately 1964, process modifications occurred and platinum bearing material was recovered for recycling (Reference K361). Prior to initiation of these modifications, the solids (cell bottoms and filter washings) were sluiced with process liquid wastes to the BMI ponds via the Beta Ditch (Reference K037, K056, K347).

Since 1964, the cell bottoms and filter cake materials have been recycled in one of three manners. Between approximately 1964 and 1970, the moist filter cake and cell bottoms were shipped off-site for platinum recovery. Between approximately 1970 and 1983, the filter cake was burned (on-site) in electric ovens near Unit 5 before being shipped off-site for platinum recovery. This was done to destroy the sodium perchlorate and obtain a higher recycling value. Since 1983, the cell bottoms and filter cake have been washed and either drummed directly or sent to SWMU (KMCC-007)

platinum recycling unit to be dried prior to being drummed and shipped off-site to a third party company for precious metal recovery of platinum (Reference K335, K336, K357, K361, K366).

Prior to January 1976, the liquid wastes were routed to the BMI ponds via the Beta Ditch (Reference K037, K056, K347). This liquid waste consisted of a brine rinse and washwater from water softeners (Reference K277). Sodium perchlorate process wastes were discharged to lined on-site surface impoundments S-1 and P-1 from the mid-1970s to prior to January 1983 (Reference K037, K039, K095, K124). After January 1983, liquid effluent from sodium perchlorate operations were recycled back to the process (Reference K357).

4-23

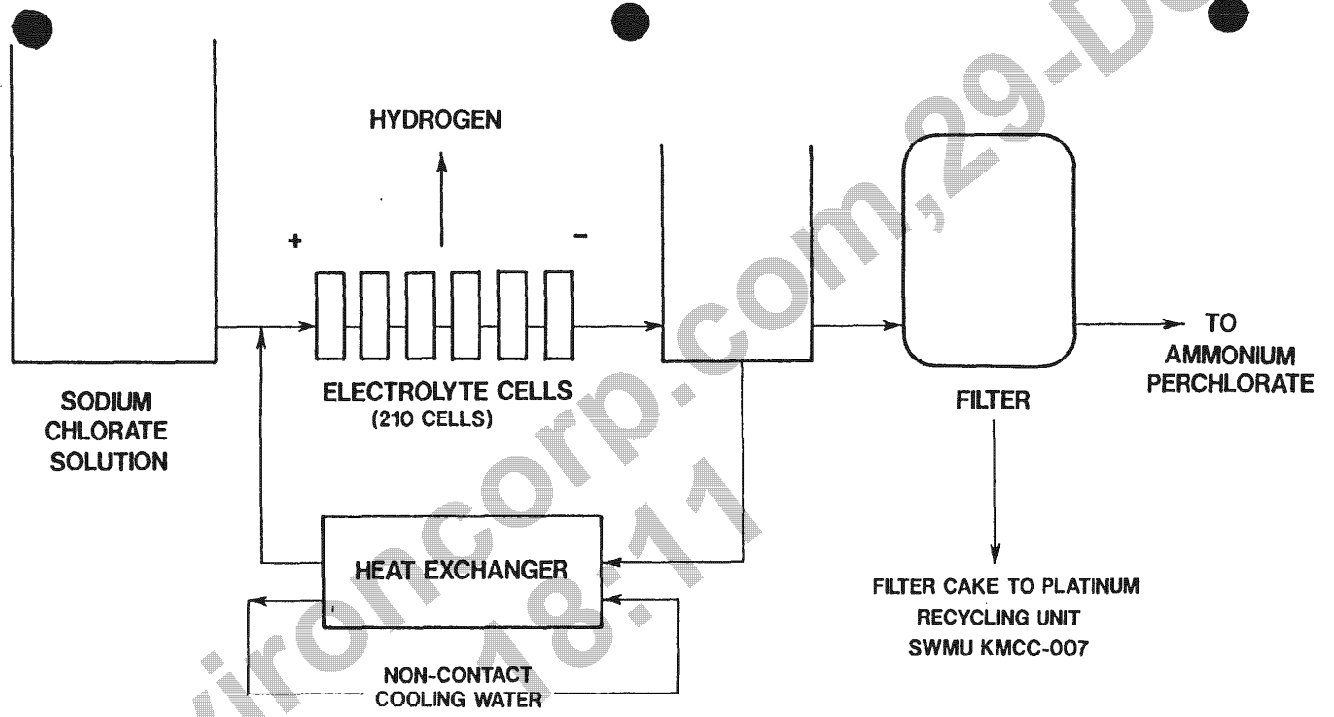

Modified after flow diagram provided by KMCC. Reference DOC #K117.

FIGURE 4.4.1
SODIUM PERCHLORATE PROCESS

31-135909-004

KMC DR
04-0008513

└

4.5 Potassium Perchlorate Process (Unit 4)

4.5.1 General Description

Potassium perchlorate was produced at the KMCC Henderson, Nevada site from 1945 until 1983 in Unit 4. Potassium perchlorate production used the same equipment as potassium chlorate production. Table 4.5.1 summarizes the amount of potassium perchlorate produced as a finished product.

TABLE 4.5.1
POTASSIUM PERCHLORATE PRODUCTION - TONS
(Reference K176)

<u>Year</u>	<u>KClO₄ Finished</u>
1951	3,077
1952	3,605
1953	3,562
1954	158
1955	651
1956	490
1957	336
1958	309
1959	378
1960	150
1961	122
1962	206
1963	117
1964	222
1965	0
1966	161
1967	304
1968	465
1969	535
1970	516
1971	344
1972	463
1973	526
1974	768
1975	266
1976	763
1977	949
1978	762
1979	830
1980	524
1981	386
1982	359
1983	(2) (*)

Note: The production amounts between 1945 and 1950 are not known.

(*) Negative number: Accounting procedure to adjust finished product tonnage which is less than production records indicate was manufactured over total years of production.

4.5.2 Raw Materials Used

The raw materials used in the production of potassium perchlorate included sodium perchlorate and potassium chloride (Reference K037, K253, CA017).

4.5.3 Production Process Flow Description

Potassium perchlorate was produced by KMCC and its predecessors between 1945 and 1983 following the same general double decomposition process as potassium chlorate, with a few modifications resulting from different physical and chemical properties.

The reaction employed was:



The very low solubility of potassium perchlorate in cold aqueous solution permitted almost complete recovery of perchlorate values from the mother liquor by refrigeration (Reference K253).

Dry potassium chloride was mixed with water in a dissolving tank and heated. The hot potassium chloride solution was filtered and added to a crystallizer tank containing sodium perchlorate solution. Crystallization of potassium perchlorate occurred immediately upon mixing. The batch was cooled with ammonia cooled rotators and readied for recovery (Reference K253).

Potassium perchlorate crystals were recovered from a slurry in a primary centrifuge and washed. The centrifuge mother liquor was discharged to the Beta Ditch via the storm sewer or to on-site ponds S-1 and P-1 via piping and represented a loss of KClO_4 , KCl , NaClO_4 and NaCl (Reference K253).

Crystals from the centrifuge were re-slurried and filtered again in a second centrifuge. The second centrifuge cake was fed to a counter-current, gas-fired rotary dryer and the dried product proceeded to storage. From storage the product was ground, screened, and packed to customer specification. Fines produced during this later process were collected in a wet scrubber control device (CCHD/APCD permit number A09506) and recycled back to the production process at the crystallizer (Reference K357).

Off-specification potassium perchlorate was redissolved and returned to the process flow for reprocessing (Reference K357). From 1945 to prior to January 1976, liquid and solid wastes from the potassium perchlorate process were discharged to the BMI ponds via the Beta Ditch (Reference K037, K056, K347). From January 1976 to 1983, these liquid and solid waste streams were discharged to the lined on-site surface impoundments S-1 and P-1. A period of operations modification for compliance with "zero discharge" occurred between 1972 and January 1976. During that time, product and waste liquids were alternately discharged to the SIs and BMI ponds as operations required (Reference K031, K037, K039, K095, K124, K366). Potassium perchlorate production ceased at the KMCC facility in September 1982 (Reference K095, K124). Section 5.0 of this report provides further information on S-1 and P-1 surface impoundments.

4.5.4 Waste Stream Characterization

Potassium perchlorate process wastes consisted of sluiced filter cakes. This material is comprised chiefly of a colloidal suspension of diatomaceous earth in a aqueous solution of potassium perchlorate mother liquor, sodium chloride, potassium chloride, potassium chlorate, sodium perchlorate, sodium carbonate, calcium carbonate, and chromium (Reference K083, K278, CA017). This solid and liquid waste was conveyed to the discharge point as a single stream. The different discharge receptacles are described in Section 4.5.3.

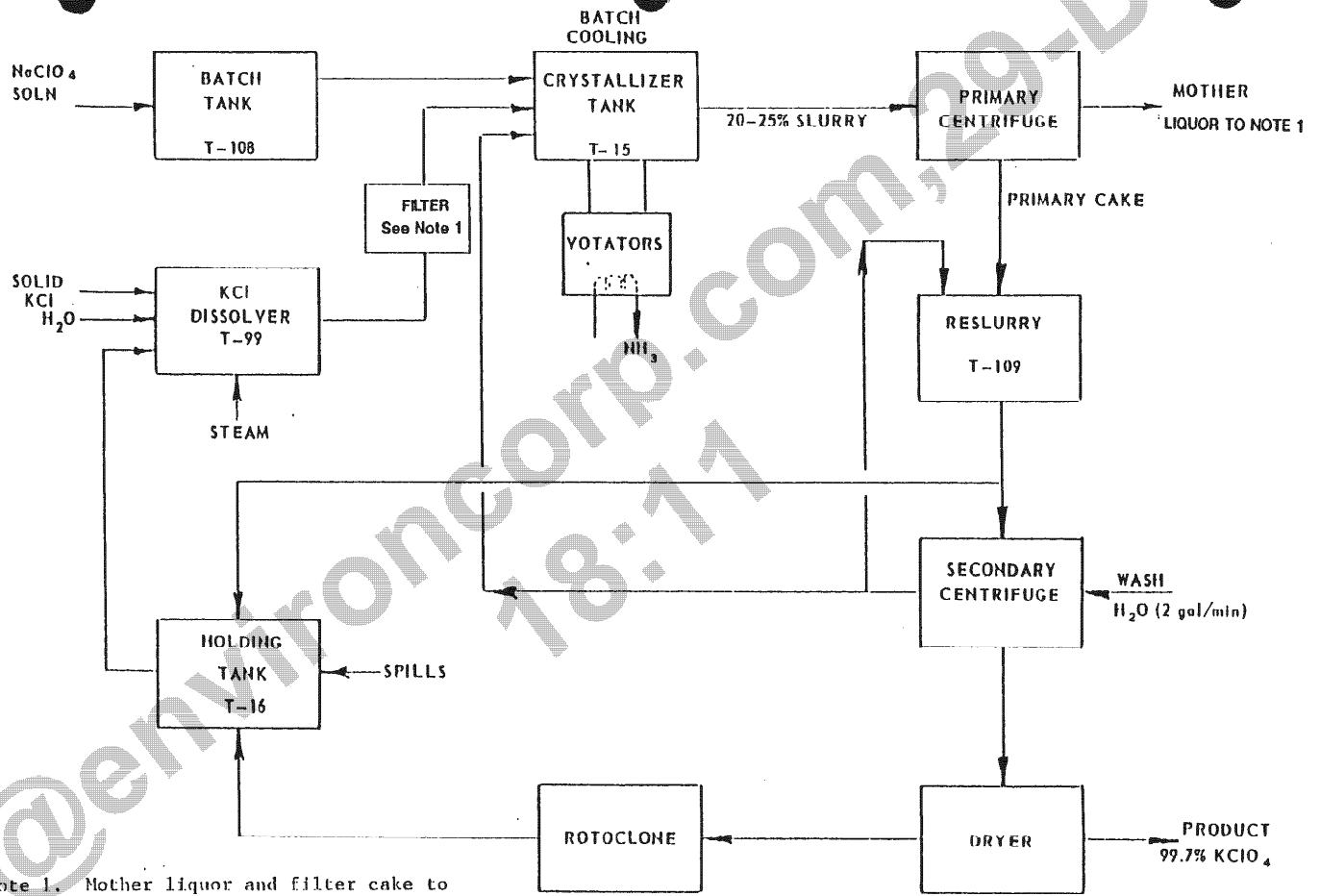

4-28

Note 1. Mother liquor and filter cake to Ponds S-1 and P-1 historically.

Modified after flow diagram provided by KMCC. Reference DOC #K253.

31-135909-004

KMC DR
 04-0008518

⌊

4.6 Magnesium Perchlorate Process (Unit 5)

4.6.1 General Description

Magnesium perchlorate was produced at the KMCC Henderson, Nevada site between 1969 and 1976 and marketed as a solution. The equipment was located in the northeast end of Unit 5. Table 4.6.1 summarizes the amount of magnesium perchlorate produced as a finished product.

TABLE 4.6.1
MAGNESIUM PERCHLORATE PRODUCTION - TONS
(Reference K176)

<u>Year</u>	<u>Mg(ClO₄)₂ Finished</u>
1969	12
1970	6
1971	0
1972	180
1973	247
1974	249
1975	42
1976	(8)(*)

Note:

(*) Negative number: accounting procedure to adjust finished product tonnage which is less than production figures indicate should have been manufactured over total years of production.

4.6.2 Raw Materials Used

The following raw materials were used in the production of magnesium perchlorate (Reference K037, K255):

- o magnesium carbonate;
- o ammonium perchlorate;
- o water;
- o hydrochloric acid; and
- o barium hydroxide.

4.6.3 Production Process Flow Description

Magnesium perchlorate solution was prepared by the reaction of magnesium carbonate and ammonium perchlorate, with steam condensate as the liquid carrier. Magnesium carbonate is only slightly soluble and reacted only as the ammonia and carbon dioxide were removed by a slow process of steam distillation. The ammonia given off was absorbed in a counter-current packed tower scrubber, using neutral to slightly acidic ammonium salt solution as the recirculating liquor. After the reaction was completed, the magnesium perchlorate batch was concentrated. Air and steam were turned off and the batch was allowed to settle before draining from reactor tank to a settling/storage tank. Figure 4.6.1 depicts the magnesium perchlorate process (Reference K255).

Sulfate impurity was removed by adding barium hydroxide. Chloride and chlorate impurities were removed by electrolysis of the concentrated magnesium perchlorate solution. Magnesium carbonate was added as necessary for pH control (Reference K255).

After settling and pH adjustment in storage tanks, the purified solution was filtered through a horizontal plate filter and packaged or bulk loaded for shipment (Reference K255).

Off-specification magnesium perchlorate solution was returned to the production flow for reprocessing (Reference K357).

From 1969 to prior to January 1976, liquid wastes from the magnesium perchlorate process were discharged to the BMI ponds via the Beta Ditch (Reference K037, K056, K347). These liquid wastes were discharged to on-site surface impoundments S-1 and P-1 during the mid 1970's until production of magnesium perchlorate ceased at the KMCC facility in 1976 (Reference K037, K039, K176, K255). Section 5.0 of this report provides further descriptions on the S-1 and P-1 surface impoundments.

4.6.4 Waste Stream Characterization

Magnesium perchlorate process wastes resulted from filter cakes and process area washdowns. The liquid stream was composed of magnesium carbonate, ammonium perchlorate, magnesium perchlorate and water. These wastes were often co-mingled as "perchlorate" wastes generated from the various simultaneously ongoing perchlorate

production processes occurring at the facility between 1945 and the mid-1970s. Between 1945 and January 1976, wastes produced by the perchlorate processes were discharged to the BMI ponds (Reference K037, K056, K347). Perchlorate wastes, including magnesium perchlorate production wastes, were discharged to the lined on-site surface impoundments S-1 and P-1 during the mid 1970s (Reference K037, K039). It was during this same time (1976) that magnesium perchlorate production ceased at the KMCC facility (Reference K037, K176, K255).

4-32

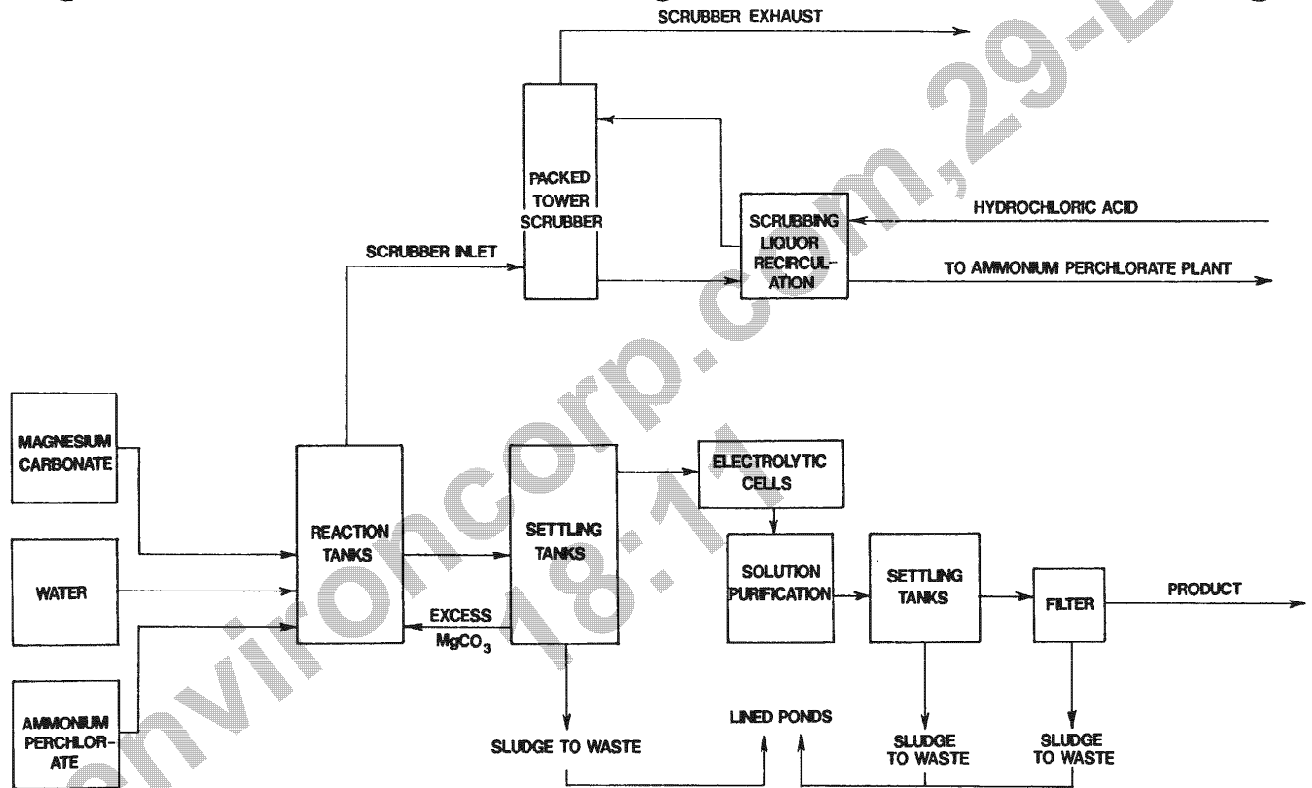

Modified after flow diagram provided by KMCC. Referenced DOC #K255; K170, K179.

**FIGURE 4.6.1
MAGNESIUM PERCHLORATE PROCESS
FLOW DIAGRAM**

31-135909-004

KMCC DR
04-0008522

└

4.7 Ammonium Perchlorate Process

4.7.1 General Description

The major portion of the sodium chlorate produced at the KMCC Henderson, Nevada site is used to produce ammonium perchlorate (AP). Ammonium perchlorate has been produced on-site since 1951 in a separate part of the facility near the central portion of the site.

Table 4.7.1 summarizes the amount of ammonium perchlorate produced as a finished product. From 1969 to 1976, some ammonium perchlorate was also used to produce magnesium perchlorate (Reference K176).

TABLE 4.7.1

AMMONIUM PERCHLORATE PRODUCTION - TONS
(Reference K176)

<u>Year</u>	<u>NH₄ ClO₄ Finished</u>
1951	379
1952	1,218
1953	1,571
1954	3,974
1955	3,239
1956	3,738
1957	3,427
1958	6,746
1959	10,888
1960	5,600
1961	10,279
1962	8,511
1963	11,220
1964	9,240
1965	3,841
1966	6,511
1967	8,456
1968	5,893
1969	6,001
1970	7,692
1971	3,835
1972	7,576
1973	6,781
1974	6,163
1975	4,443
1976	5,152
1977	5,857
1978	5,151
1979	6,542
1980	6,282
1981	6,174
1982	7,075
1983	8,531
1984	12,366
1985	14,116
1986	14,758
1987	14,053
1988	15,368
1989	18,033
1990	18,478

4.7.2 Raw Materials Used

The following raw materials are used in the production of ammonium perchlorate (Reference K037, K253, CA017).

- o sodium perchlorate;
- o anhydrous ammonia;
- o hydrochloric acid;
- o soda ash;
- o caustic soda;
- o cellulose filter aid;
- o diatomaceous earth;
- o tricalcium phosphate (anti-caking agent); and
- o sulfur dioxide.

4.7.3 Production Process Flow Description

The main AP production process is presented first, followed by a section on the AP process evaporation ponds, also known as AP surface impoundments. Figure 4.7.1 is a simplified process flow diagram of the ammonium perchlorate production process.

Ammonium perchlorate is produced from the double decomposition reaction:

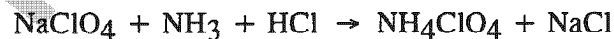

This reaction occurs in the symbol labeled "Reactor" on Figure 4.7.1. Sodium chloride produced in this process is cycled back to the sodium chlorate process.

The acid and ammonia used in this reaction are of high purity and need no treatment before introduction to the process. However, the feed sodium perchlorate must be treated and "purified" before it can be used (Reference K253).

This sodium perchlorate purification process step is not shown on Figure 4.7.1. Recycled sodium perchlorate in the AP production scheme is treated in the area labeled "Purification" on Figure 4.7.1.

The impurities in the sodium perchlorate solution include sodium chlorate, calcium anions, and sodium dichromate. The chromate impurity is completely removed from the sodium perchlorate solution before entering the process by reduction with sulfur dioxide and is removed from treated solution by filtration (Reference K253).

Soda ash is also used in this purification step to precipitate calcium impurity from the perchlorate solution. The cakes generated in this purification process at filters AY-7 and AY-13 contain chromic hydroxide and calcium carbonate. This filter cake is routed to AP surface impoundments AP-1 and AP-2 (Reference K031, K039, K158A).

Another impurity to be removed from the sodium perchlorate solution is sodium chlorate. The chlorate destruction process occurs in one of the first vessels in a series of reaction vessels located near the crystallizer building. Chromate free sodium perchlorate solution is mixed with hydrochloric acid and ammonia, to decompose the chlorate impurity (Reference K253). The equipment is not shown on Figure 4.7.1.

Prior to approximately January 1976, the chlorate destruction vapors were historically passed through a lime scrubber tower (chlorine gas scrubber CCHD/APCD Permit Number A09503) in which chlorine, chlorine derivatives, and hydrochloric acid were absorbed. This waste stream was then discharged to the Beta Ditch, co-mingled with other liquid waste streams, and discharged to the BMI ponds (Reference K037, K253).

After 1976, solution from the chlorine gas scrubber was recycled to the sodium chlorate operations.

The particulate air emissions control devices consist of Rotoclones (CCHD/APCD Permit Numbers A09512 and A09516) (Reference K372). KMCC utilizes type "N" Rotoclones. Type N Rotoclone cleans the air by the combined action of centrifugal force and a thorough intermixing of water and dust-laden air. The dust is separated from the air by means of a water curtain, created by the flow of air through a partially submerged stationary impeller. Air flowing through the impeller at a high velocity

conveys water with it in a very turbulent sheet. Submersion is accomplished by the centrifugal force exerted by rapid changes in direction of air flow which causes the dust particles to penetrate the water film and become permanently trapped.

Entrained moisture in the cleaned air is removed by specially designed, wide-space chevron eliminators or curved entrainment baffles.

The water in the reservoir is continually reused and since the water curtain is produced by the air flow, no pumps or nozzles are required. The water level is maintained by the overflow weir in a control box as long as a small amount of fresh water is supplied through the make-up water connection or by electrical controls that automatically add water, as required, to compensate for evaporation and water lost as the collected dust is removed from the unit.

The sodium chloride slurry is pumped from the crystallizer to a centrifuge. The crystal is separated from the mother liquor with the liquor recycled to the reactor system (Reference K253).

The sodium chloride crystal is washed with water to remove surface mother liquor, then drops to a conveyor feeding the sodium chloride calciner. The sodium chloride crystal washwater is routed to AP process surface impoundment AP-4 for reconcentration and eventual recycle back into the process. In the calciner, sodium chloride is heated above the decomposition temperature of ammonium perchlorate to remove the last small amounts of ammonium perchlorate in the salt. The perchlorate-free sodium chloride is conveyed to hopper cars for recycling to the sodium chlorate plant, while the dust from the calciner operation is used for water softener regeneration at the crystallizer building (Reference K158A, K253).

The handling of the ammonium perchlorate crystals recovered at the " NH_4ClO_4 centrifuge", as labeled on Figure 4.7.1, is presented in the following paragraphs. The ammonium perchlorate crystal from the centrifuge is re-slurried and pumped to a concentrator and centrifuge in the dryer building. The mother liquor from the re-slurry

loop is returned to the crystallizer building. The ammonium perchlorate is dried and passed to the screening equipment (Reference K253).

The ammonium perchlorate from the screening operation passes into double cone blenders from which it is packed into lots. Anti-caking agents may be added to the blended lots to customer specification (Reference K253).

Nearly all of the ammonium perchlorate shipped has been cross blended to produce homogeneous, blended lots. All cross blended material can be packed, stored, and shipped in either drums or bins (Reference K253).

Off-specification ammonium perchlorate is redissolved and returned to the production flow for reprocessing (Reference K357).

KMCC operates five (5) lined on-site process surface impoundments (SIs) related to the manufacturing of ammonium perchlorate. The SIs are designated AP-1 through AP-5. These SIs are used to temporarily store solutions from the production process and AP plant cooling towers for recycling to the process. A brief summary of each follows.

AP-1 and AP-2

The AP-1 SI is equipped with a double liner system. The bottom liner consists of a 40 mil. high density polyethylene (HDPE) membrane, the side underliner is comprised of 400 gm/m² weight polypropylene geotextile, and the top liner consists of 60 mil. HDPE. This SI has an approximate surface area of 14,000 square feet and an approximate volume of 370,000 gallons (Reference K158A).

The AP-2 SI is a single lined impoundment. The bottom liner consists of polyvinyl chloride (PVC) and the side underliner is comprised of reinforced butyl rubber. The SI has an approximate surface area of 14,000 square feet and an approximate volume of 400,000 gallons (Reference K158A).

Process solutions from sodium perchlorate purification and filter wash liquor from ammonium perchlorate purification are temporarily stored in these SIs. SIs AP-1 and AP-2 serve the same purpose with only one SI being active at any given time

(Reference K031, K039, K158A). Both SIs have recently had the sludge removed from them. This sludge removal occurred in October and December in 1989. The sludge was disposed off-site at U.S. Ecology in Betty, Nevada (Reference K371) (see Table C-1).

AP-3

SI AP-3 is equipped with a double liner system. The bottom liner consists of a 40 mil. HDPE membrane, the side underliner is comprised of polypropylene geotextile with a weight of 400 gm/m², and the top liner consists of 60 mil. HDPE. The SI has an approximate surface area of 2,000 square feet and an approximate volume of 65,000 gallons (Reference K158A).

This SI is used as a pump basin for liquids stored in SIs AP-1 and AP-2 from filter wash liquor of sodium perchlorate/ammonium perchlorate purification. The process solutions stored in AP-3 are the same as described above for surface impoundments AP-1 and AP-2 (Reference K031, K039, K158A). The sludge was recently removed from this SI and disposed off-site at U.S. Ecology (Reference K253).

AP-4

The AP-4 SI is equipped with a double liner system. The bottom liner consists of a 40 mil. HDPE membrane, the side underliner is comprised of polypropylene geotextile with a weight of 400 gm/m², and the top liner consists of 60 mil. HDPE. The SI has an approximate surface area of 20,000 square feet and an approximate volume of 720,000 gallons (Reference K158A).

This SI functions as a surge basin to store unusual flows from the ammonium perchlorate cooling towers. Additionally, salt crystallizer washout and minor flows from the ammonium perchlorate process are routed to this SI. Liquor from this SI is used to make up for evaporation losses in SIs AP-1 and AP-2, thereby being returned to the process (Reference K031, K039, K158A).

AP-5

SI AP-5 is equipped with a double liner system. The bottom liner consists of a 40 mil. HDPE membrane, the side underliner is comprised of polypropylene geotextile with a

weight of 400 gm/m^2 , and the top liner consists of 60 mil. HDPE. The SI has an approximate surface area of 35,000 square feet and an approximate volume of 1,817,000 gallons (Reference K158A).

This SI also functions to contain flows from the ammonium perchlorate cooling tower (Reference K158A).

KMCC files document that prior to January 1976, the dissolving tank, dryer feed screw and cyclone dust (Rotoclone) generating streams were slurried to the BMI ponds via the Beta Ditch. The combined stream carried about two to three tons per day of salt (Reference K278, K347). Other discharges were associated with AP Plant filters AY-7 and AY-13. These discharges contained NH_4ClO_4 , NaCl , NaClO_4 , $\text{Cr}(\text{OH})_3$, and $\text{Fe}(\text{OH})_3$ (Reference K278).

4.7.4 Waste Stream Characterization

From 1951 to 1974, the ammonium perchlorate filter cake from AP plant filters AY-7 and/or AY-13; and the dissolving tank, dryer feed screw, and cyclone dust (Rotoclone) generating stream were slurried via the Beta Ditch to the BMI ponds. As noted previously, this combined stream contained NH_4ClO_4 , NaCl , NaClO_4 , $\text{Cr}(\text{OH})_3$, and $\text{Fe}(\text{OH})_3$. In May 1974, process modifications were completed to change this waste stream to a recycled product stream. Consequently, three surface impoundments were constructed. Ammonium perchlorate filter wash liquor and filter cake from the sodium perchlorate filtration and purification process, and the aforementioned dissolving tank, dryer feed screw, and cyclone dust (Rotoclone) generating streams are currently routed to surface impoundments AP-1, AP-2 and AP-3. The solution in these lined on-site impoundments is concentrated by evaporation and recycled back to the process (Reference K031, K039, K158A, UE030).

These three AP process surface impoundments (AP-1, AP-2, and AP-3) were placed into service in May 1974. Solids were removed from some of the SIs (pre-1980) and in 1983, 1989, and 1990. The solids were washed, filtered and dried, then sent to an

off-site disposal facility as nonhazardous wastes. The solids consisted of CaCO_3 , CaSO_4 , MgSO_4 , $\text{Cr}(\text{OH})_3$ and diatomaceous earth (Reference K210, K214, K305, K320, UE030).

Currently, sodium chloride calciner scrubber liquid is recycled back to the AP process. This liquid contains ammonium chloride, neutralized carbonic acid, and neutralized dilute hydrochloric acid (Reference K253).

Caustic scrubber solution (NaOH) from the AP process is recycled to sodium chlorate production through Pond New P-2 or directly to chlorate operations. This effluent was formerly discharged to Pond Old P-2 formerly discharged to Pond Old P-2 (Reference K357).

The AP cooling tower overflows historically drained via the Beta Ditch to the BMI ponds. Currently the overflow is routed through an underground line to surface impoundments AP-4 and AP-5. The overflow solution consists of ammonium perchlorate and sodium chloride (Reference K357).

Crystals from the "NaCl Crystallizer", " NH_4ClO_4 Crystallizer" and the "AP Centrifuge" are separately washed with water. The resulting washwater is routed to SI AP-4. The liquor is concentrated by evaporation and is eventually recycled back to the AP production process (Reference K039, K253).

Emission control devices (Rotoclones-CCHD/APCD Permit Numbers A09512 and A09516) (Reference K372) capture the dust generated during NH_4ClO_4 drying, screening, and packaging. The Rotoclones are water bath emission control devices. Ammonium perchlorate particulates are dissolved in the water bath and recycled to the product process.

Discharges from the lime scrubber tower (chlorine gas scrubber) emission control device are currently permitted under CCHD/APCD Permit Number A09503. Emissions from this scrubber are non-depositional.

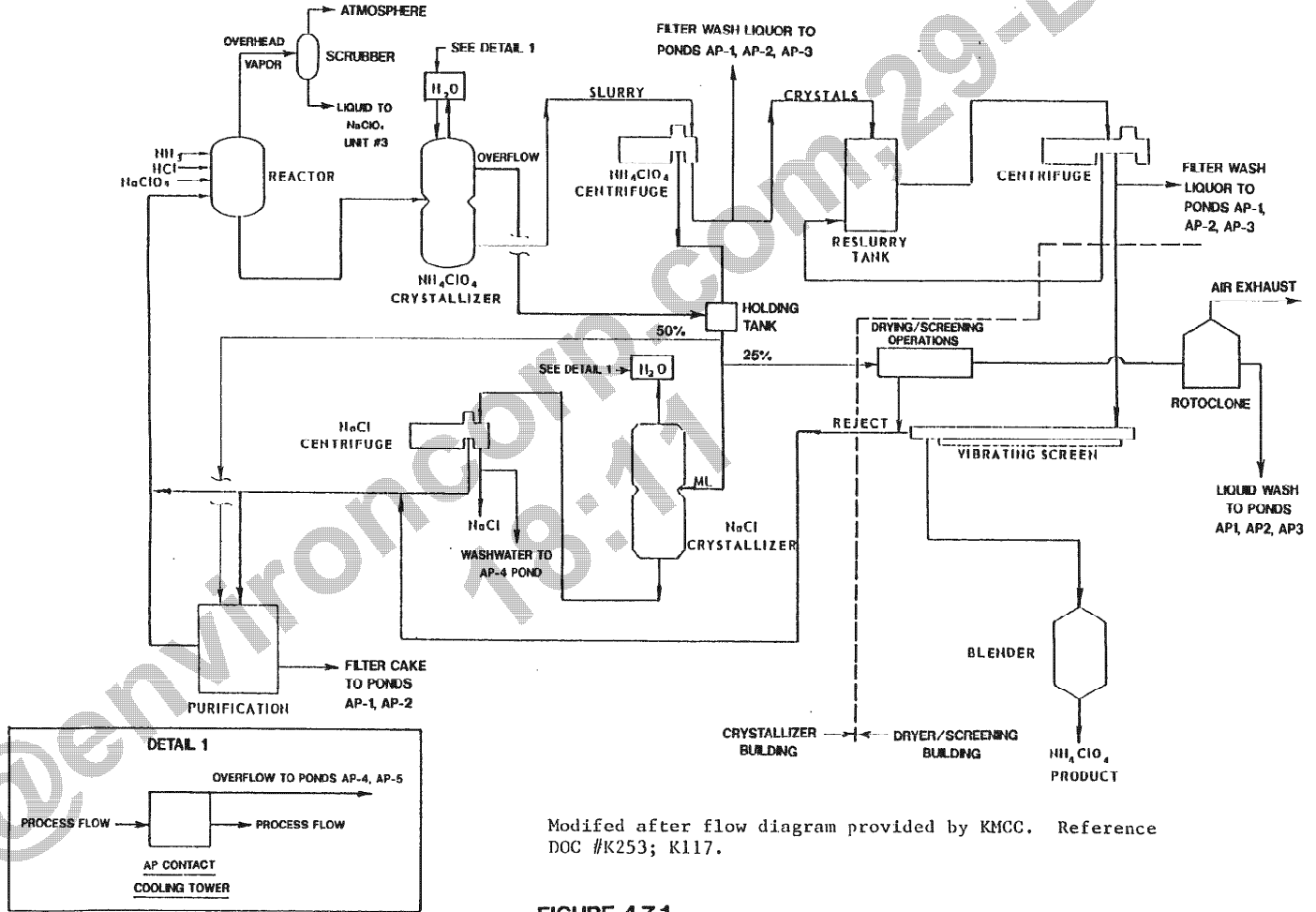

Modified after flow diagram provided by KMCC. Reference DOC #K253; K117.

FIGURE 4.7.1

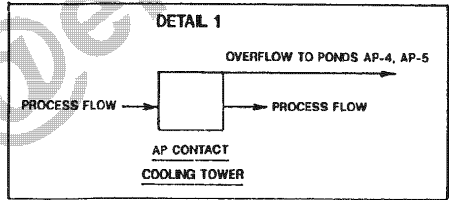

31-135909-004

KMC DR
04-0008532

4.8 Manganese Dioxide Process (Unit 6)

4.8.1 General Description

Manganese dioxide ore is reduced, leached, and the leachate purified to produce a concentrated manganese sulfate solution at the manganese dioxide leach plant (Please reference Section 4.9 of this report for a description of the manganese dioxide leach plant process). This solution is then fed to the electrolytic cells in Unit 6 where high purity manganese dioxide is plated out of solution. This high purity, battery active manganese dioxide is used in the manufacture of high quality dry cell batteries. Table 4.8.1 summarizes manganese dioxide production from 1951 through 1990 (Reference K176, K253).

TABLE 4.8.1

MANGANESE DIOXIDE PRODUCTION - TONS
(Reference K176)

<u>Year</u>	<u>MnO₂ Finished</u>
1951	251
1952	590
1953	2,355
1954	3,030
1955	3,576
1956	4,052
1957	4,385
1958	3,548
1959	819
1960	1,825
1961	2,935
1962	2,590
1963	4,440
1964	4,018
1965	3,960
1966	5,284
1967	5,922
1968	6,419
1969	6,059
1970	4,670
1971	5,631
1972	7,257
1973	8,516
1974	8,689
1975	7,573
1976	8,831
1977	11,283
1978	11,783
1979	12,131
1980	11,761
1981	11,647
1982	8,768
1983	6,062
1984	7,384
1985	6,091
1986	9,279
1987	11,921
1988	10,924
1989	15,054
1990	15,815

4.8.2 Raw Materials Used

The materials used in the production of high purity manganese dioxide in Unit 6 include manganese sulfate solution from the leach plant and paraffin wax (Reference K117, K253).

4.8.3 Production Process Flow Description

Figures 4.8.1, 4.8.2, and 4.8.3 provide simplified process block flow diagrams for electrolysis of MnO₂, classifying finished MnO₂ product, and packaging of finished MnO₂ product (Reference K253).

A relatively pure manganese sulfate solution is fed to the electrolytic cells where the manganese dioxide is plated out:



The cell solution is recycled back to the leach plant for reuse. Figure 4.8.1 is a flow diagram of the manganese dioxide electrolysis process (Reference K253). The electrolytic cell process is permitted by CCHD/APCD Permit Number A09520Z (Reference K372).

The pure manganese dioxide is stripped from the anode, crushed to pass through a U.S. Standard sieve and washed to remove residual manganese sulfate and sulfuric acid. The powdered manganese dioxide is then filtered, dried, and bagged for shipment. The exhaust from the drier passes through a cyclone to a baghouse. The baghouse is permitted by CCHD/APCD Permit Number A09521 (Reference K372). Figure 4.8.2 and 4.8.3 are flow diagrams of manganese dioxide handling systems (Reference K253).

Historically, the electrolytic cell was configured to use graphite anodes. A distinct and separate cathode was not needed in the manganese dioxide cells. The spent graphite anodes were crushed along with the manganese dioxide, and then r anodes were cru

mechanical jig. Scrap and spent graphite anodes were sold to steel mills and foundries between 1960 through November 1981. The graphite anodes have since been replaced with titanium anodes (Reference K322, K323, K324).

In 1974 the system was modified with copper cathodes. These cathodes required washing. Manganese dioxide cathode wash solution has been discharged to lined on-site surface impoundments C-1 or MN-1 since 1975. Since 1989, the cathode wash solution has been discharged to SI MN-1. The wash solution consists of water, sodium hexametaphosphate, calcium, magnesium, manganese from cathode scale, and tank mud (Reference K117, K158A, K269). Descriptions of surface impoundments C-1 and MN-1 are provided in Sections 5.11 and 5.12, respectively. Prior to 1975, this solution did not exist.

Off-specification manganese dioxide is returned to the production process for reprocessing (Reference K357).

Manganese dioxide product wash water was discharged to the City of Henderson sanitary sewer system prior to May 1989. This flow was diverted to on-site wastewater collection ponds WC-1 and WC-2 in May 1989 (Reference K158A, K356).

4.8.4 Waste Stream Characterization

Wastes from this process are collected and disposed of on-site or recycled back to the leach plant.

The cathode wash waste is a sodium hexametaphosphate solution used to clean the electrodes (Reference K253). The wash solution consists of water, hexametaphosphate, calcium, magnesium, manganese (from cathode scale), and tank mud (manganese dioxide). Prior to January 1976, this waste had been discharged to the lined on-site surface impoundments MN-1 and C-1 (Reference K117, K158A, K347). This solution was discharged to surface impoundment C-1 (circa 1980) in batches of approximately 5,000 gallons, once or twice a week (Reference ND004). After 1989, and continuing to present, this solution has been discharged to SI MN-1.

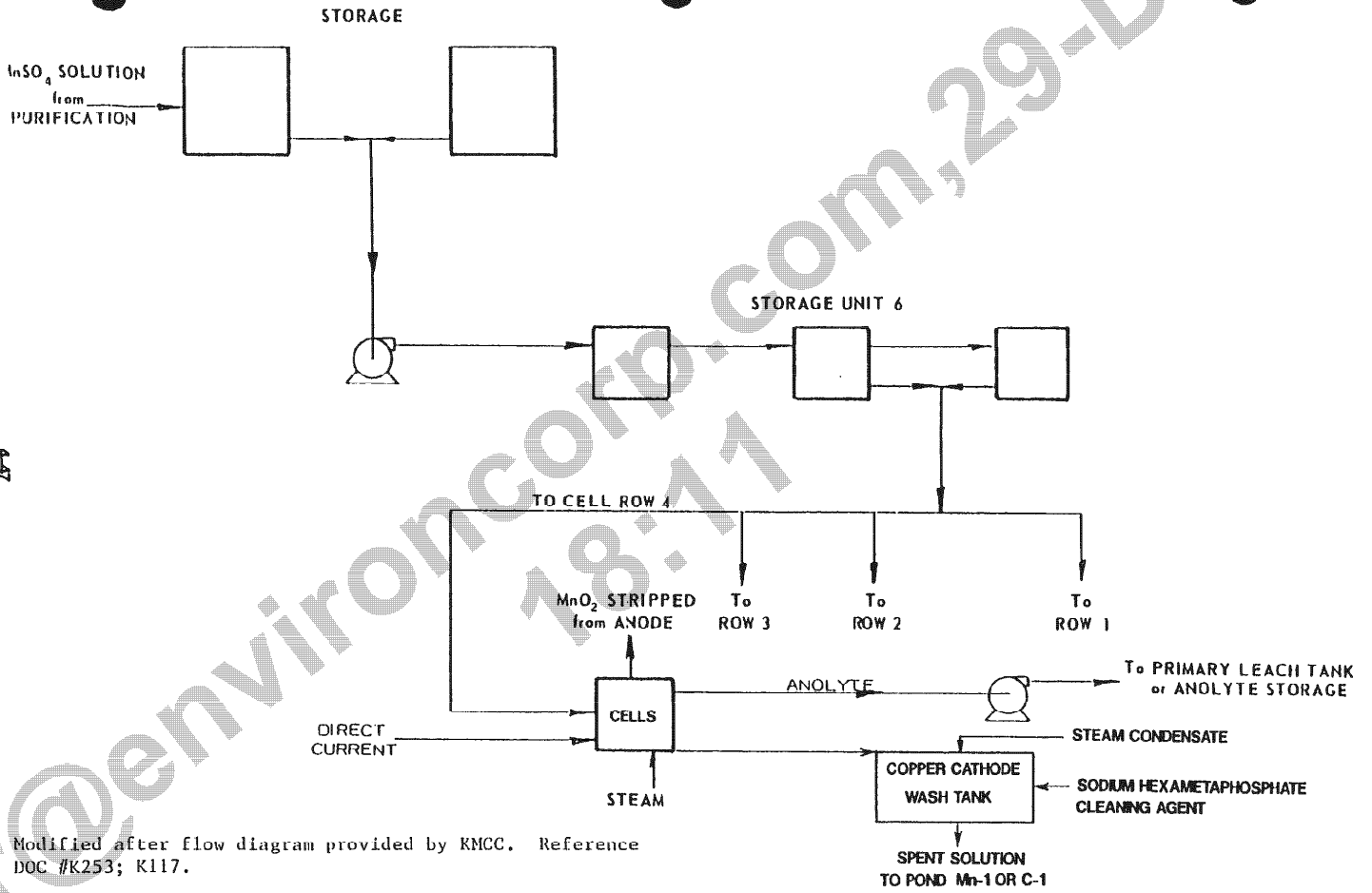
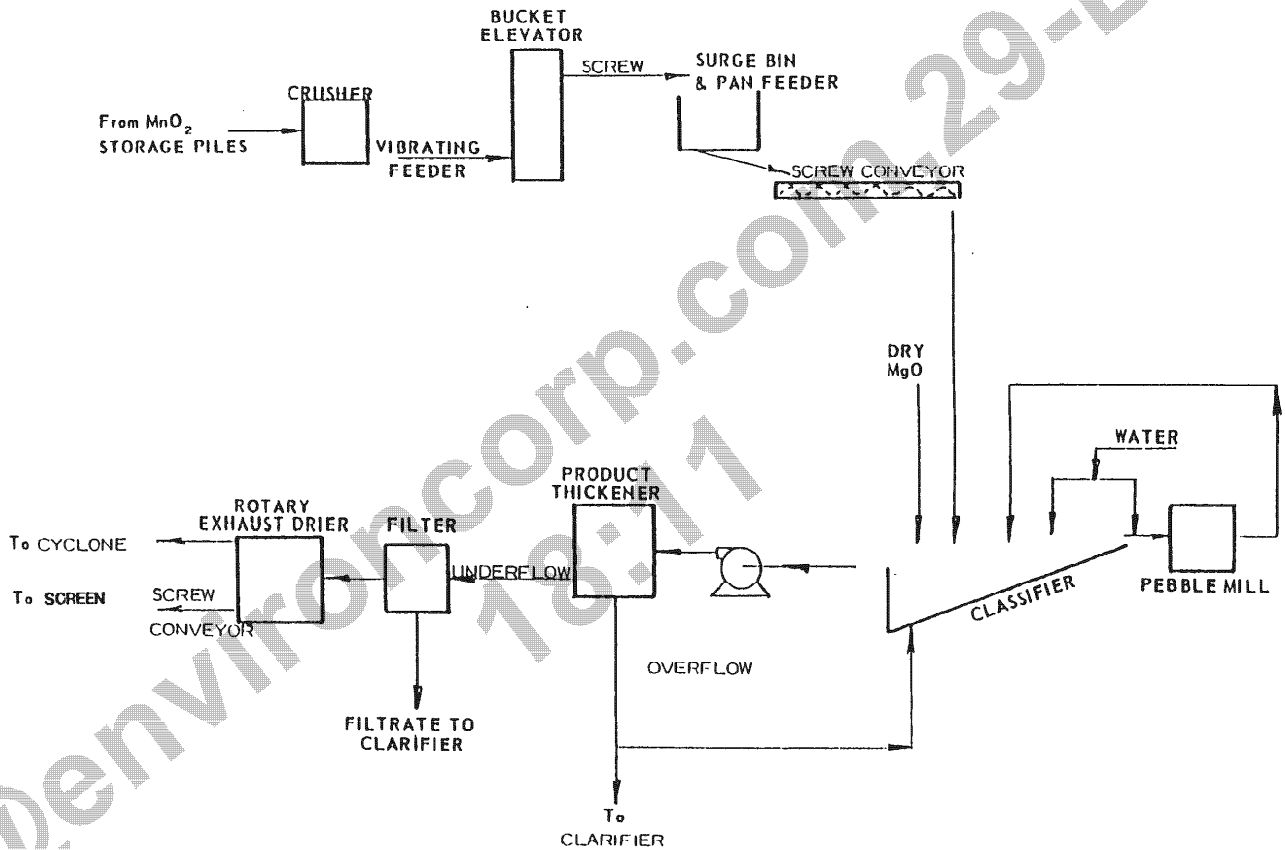

FIGURE 4.8.1
MANGANESE DIOXIDE PROCESS

31-135909-004

KMC DR
04-0008537

⌋



Flow diagram provided by KNCC. Reference DOC #K253.

FIGURE 4.8.2
MANGANESE DIOXIDE PROCESS

31-135909-004

KMC DR
04-0008538

⌋

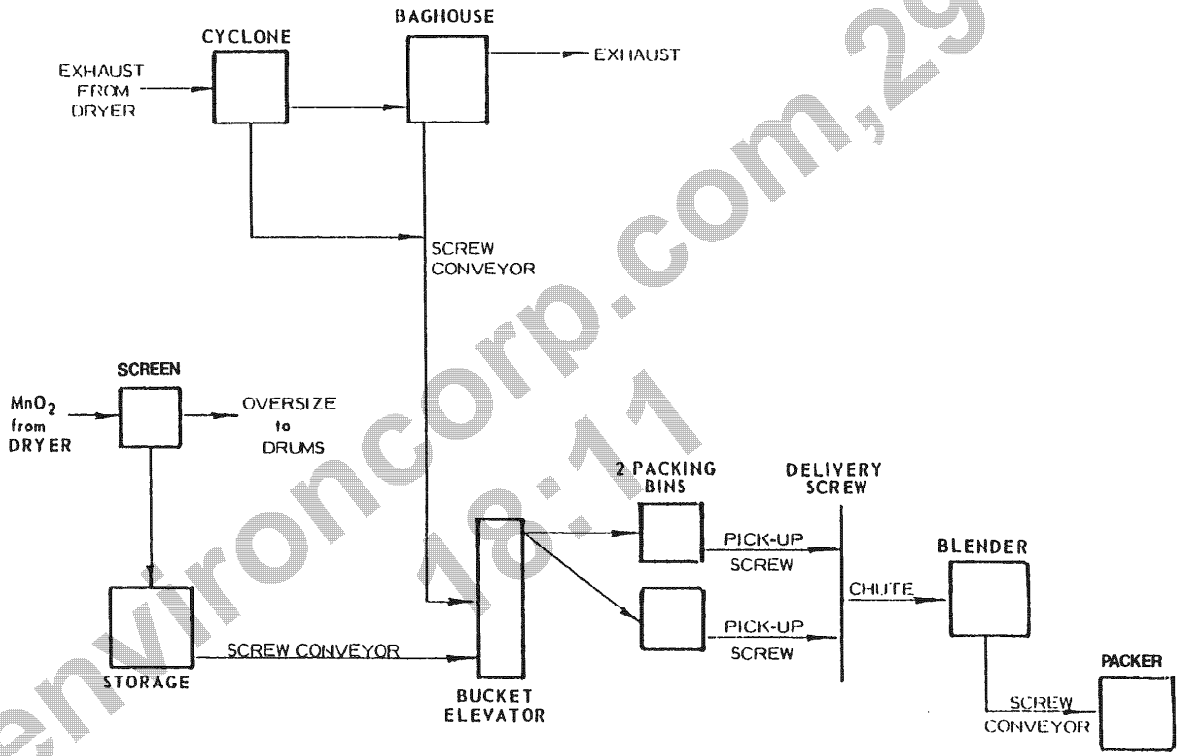

Flow diagram provided by KMCC. Reference DOC #K253.

**FIGURE 4.8.3
MANGANESE DIOXIDE PROCESS**

31-135909-004

KMC DR
 04-0008539

⌊

4.9 Manganese Dioxide Leach Plant

4.9.1 General Description

The manganese dioxide leach plant starts with manganese dioxide ore and produces a concentrated manganese sulfate solution. The solution is sent to electrolysis where high purity manganese dioxide is plated out of solution in Unit 6 (Please reference Section 4.8 for the description of the manganese dioxide process). The manganese dioxide leach plant is located north of Unit 6.

4.9.2 Raw Materials Used

The following raw materials are used in the leach plant area related processes (Reference K037, K253, CA017):

- o manganese dioxide ore (20 to 75 percent by weight manganese dioxide);
- o coal, coke or natural gas;
- o sulfuric acid;
- o barium sulfide;
- o diatomaceous earth;
- o lime (dolomitic);
- o hydrogen sulfide; and
- o flocculent.

4.9.3 Production Process Flow Description

Figures 4.9.1, 4.9.2, and 4.9.3 are simplified process block flow drawings of the manganese dioxide calcining, leaching, and purifying processes that occur in the leach plant area of the facility (Reference K253).

Figure 4.9.1 is a flow diagram of the calcining process. Ground manganese ore is calcined on open hearths. These open hearths are operated under CCHD/APCD Permit Number A09516Z (Reference K372). During the calcining process, the insoluble

manganese dioxide is reduced to soluble manganese oxide. The calcined ore is slurried into a thickener with the underflow of solids from the thickener fed to the leach tanks. From approximately 1983 through September 1989, calcine belt filter washwater was used to rinse the manganese ore to remove potassium. This washwater was sent to surface impoundment Mn-1. The wastewater stream contained potassium, potassium phosphate, manganese, and other naturally occurring trace constituents. The calcine filter washwater was eliminated in September 1989 (Reference K117, K253, K334). The air exhaust from the hearths is directed toward a baghouse which controls particulate matter emissions. This device operates under CCHD/APCD Permit Number A09515Z (Reference K372).

Figure 4.9.2 is a flow diagram for the leaching process. Anolyte from the electrolysis cells and sulfuric acid are mixed with the ore slurry in the leach tanks and pumped to an acid thickener. The overflow from the thickener is used to slurry the calcined ore. The underflow from acid thickener is filtered and returned to the thickener. Prior to 1975, the filter sludge was not dewatered but discharged directly to leach beds in what is currently the permitted, nonhazardous tailings area (Reference K056, K253).

Currently, the filter cake (tailings) generated in the leaching step is washed and sent to the permitted, on-site nonhazardous tailings area (Reference K037, K039, K056).

Figure 4.9.3 is a flow diagram for the purification process. In the purification section either hydrogen sulfide or barium sulfide is/was added to the concentrated manganese sulfate solution to precipitate zinc, copper, cobalt, lead, and nickel. These metals are precipitated as sulfides, filtered, and sent to the permitted, on-site nonhazardous tailings landfill. Barium sulfide was historically used to precipitate sulfide solids from approximately 1951 to the mid-1970s. The use of hydrogen sulfide began in mid-1970. This conversion to hydrogen sulfide (a gas) accomplished two objectives: 1) it provided a faster reaction, and 2) it reduced the volume of precipitated solids that required handling. The overflow from the purification section thickeners is filtered and stored in the manganese dioxide plant (Reference K253, K275, K357, K366).

4.9.4 Waste Stream Characterization

The manganese dioxide leach plant area generates leach acid thickener underflow sludge consisting of undigested manganese dioxide ore, insoluble silica and alumina (Reference K037, K158A, K253, K357). This underflow sludge goes to a filter wash to remove the last soluble manganese, resulting in filter cake and liquid. The waste stream from this process includes:

- o cake from the product filter generates a sludge consisting of sulfides of zinc, copper, lead, and nickel;
- o the discontinued barium sulfide purification waste stream consisting of the sulfides of zinc, copper, lead, nickel, and barium; and
- o the (historic) calcine belt filter wash containing potassium and potassium phosphate, manganese, and other naturally occurring trace constituents.

Prior to February 1975, the sludges were not filtered or dewatered before being discharged to the tailings area but were sluiced directly into on-site leach beds (Reference K037, K039, K056). By February 1975, KMCC had installed process filters (Reference K056, UE030) and filtered sludges are now sent to the on-site, nonhazardous tailings area (Reference K056). The liquid from the filters is recycled to the leach plant (Reference K253).

The sludge generated from the manganese dioxide cathode washdown activity has been sent to surface impoundment C-1 since October 1975. From 1989 to present, some of this manganese dioxide cathode washdown has been infrequently disposed of into surface impoundment MN-1 (Reference SWMU KMCC-012).

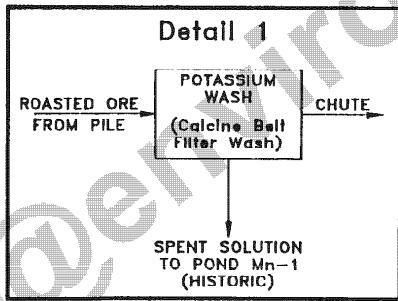
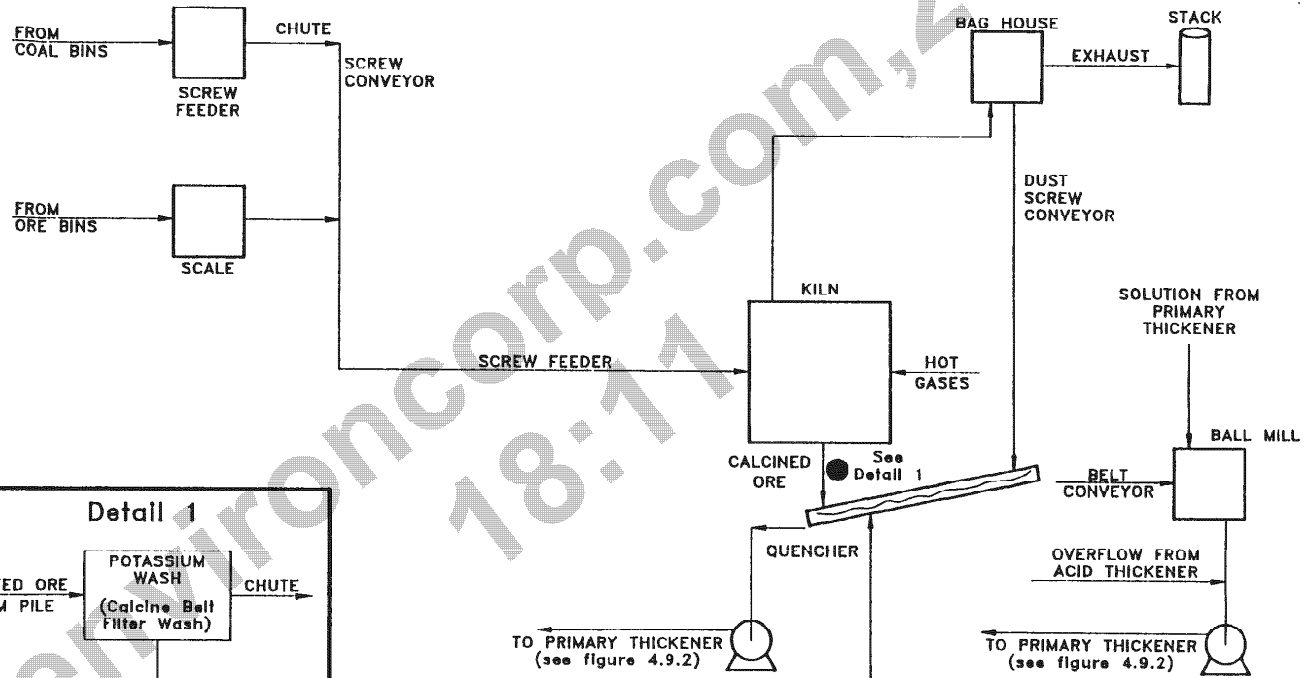

FIGURE 4.9.1
MANGANESE DIOXIDE LEACH PLANT PROCESS
(CALCINING PORTION)

Modified after flow diagram provided by KMCC. Reference DOC #K253; K117.

4-53

31-135909-004

KMCC DR
04-0008543

L

4-54

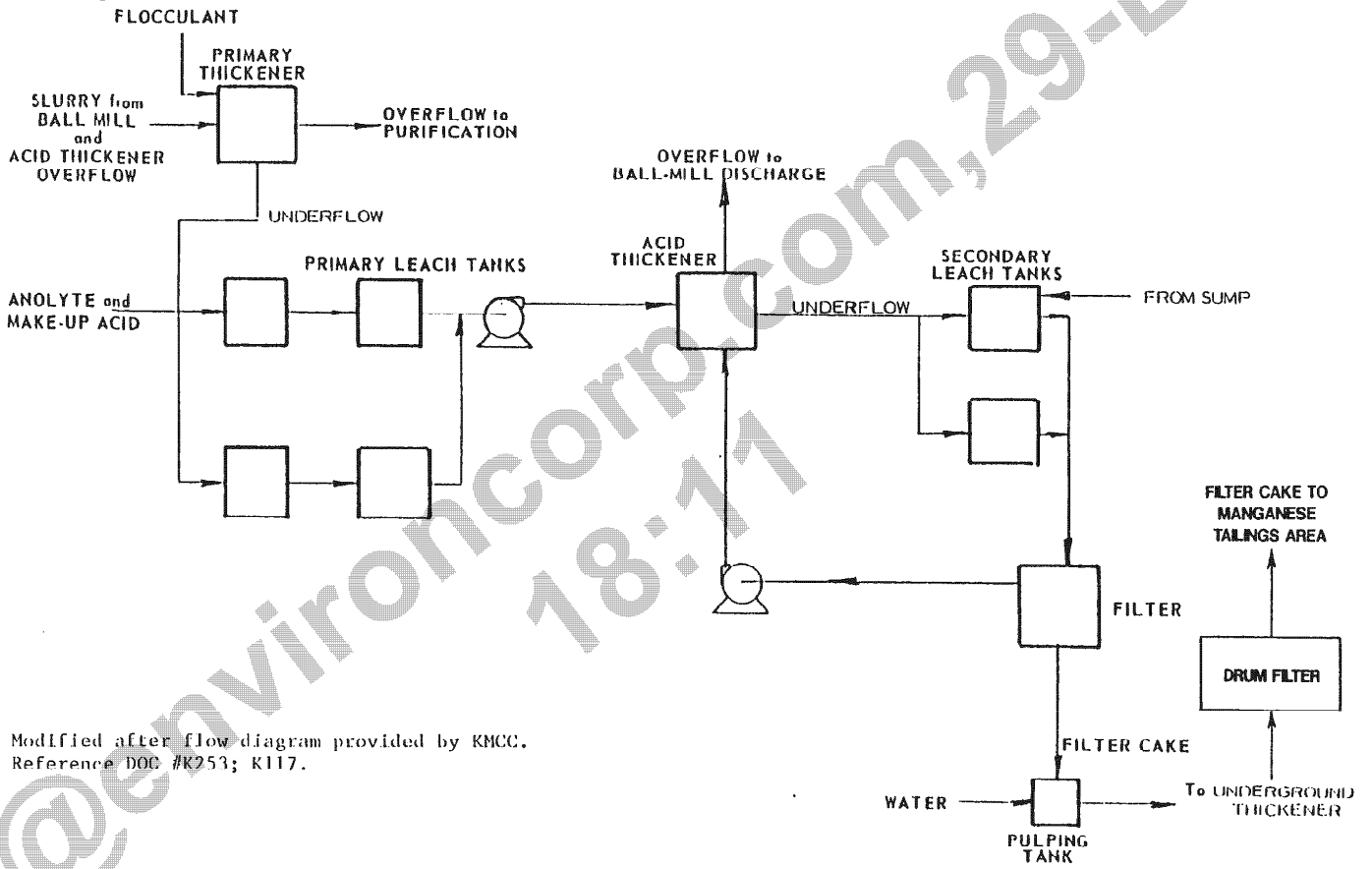

Modified after flow diagram provided by KMCC.
Reference DOC #K253; K117.

FIGURE 4.9.2
MANGANESE DIOXIDE LEACH PLANT PROCESS
(LEACHING PORTION)

31-135909-004

KMC DR
04-0008544

T

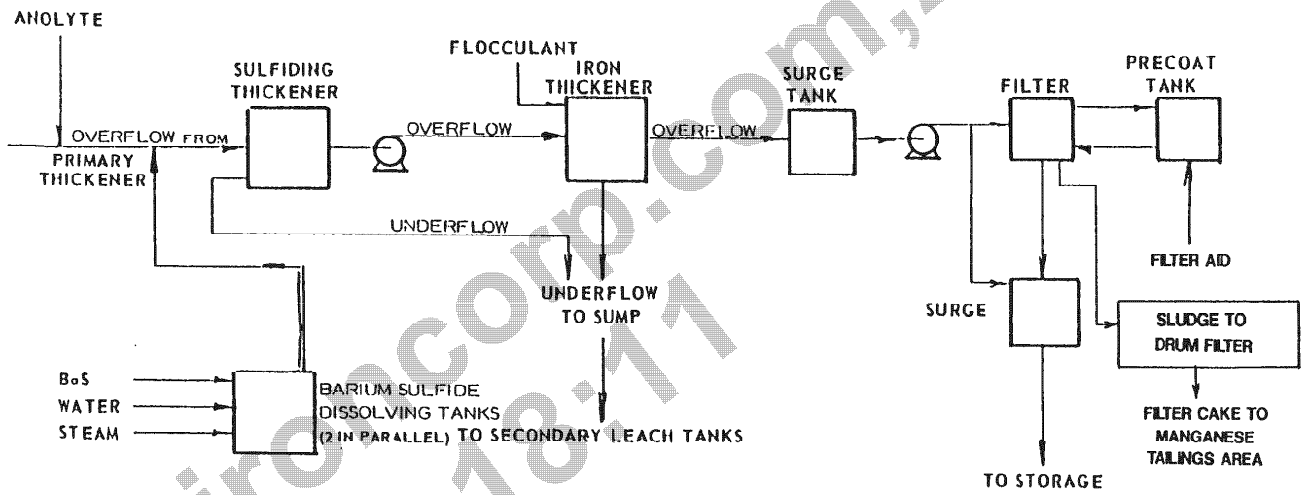

Modified after flow diagram provided by KMCC. Reference DOC #K253.

FIGURE 4.9.3
MANGANESE DIOXIDE LEACH PLANT PROCESS
(PURIFICATION PORTION)
FLOW DIAGRAM

31-135909-004

KMC DR
04-0008545

4.10 Elemental Boron Process (Unit 5)

4.10.1 General Description

Elemental boron production was begun at the KMCC Henderson, Nevada site in 1972. Table 4.10.1 summarizes the amount of elemental boron produced as a finished product between 1972 and 1990.

TABLE 4.10.1

ELEMENTAL BORON PRODUCTION - POUNDS
(Reference K176)

<u>Year</u>	<u>Boron</u>
1972	1,841
1973	11,141
1974	10,049
1975	8,888
1976	8,288
1977	9,454
1978	14,108
1979	12,904
1980	21,303
1981	15,027
1982	14,547
1983	14,369
1984	11,263
1985	12,874
1986	8,646
1987	19,089
1988	11,865
1989	8,084
1990	9,983

4.10.2 Raw Materials Used

The raw materials used in the elemental boron process include the following (Reference K037, K258, CA017):

- o boric acid;
- o magnesium metal;
- o argon;

- o sulfuric acid, (98 percent);
- o steam; and
- o soda ash.

4.10.3 Production Process Flow Description

Figure 4.10.1 shows the flow diagram for the elemental boron process.

Anhydrous boric acid and magnesium metal are combined in a blender constituting a batch. The batch is blended and loaded into trays and ignited within a reaction chamber. When the reaction is complete, the product is ground in a crusher and prepared for leaching. The crushed product is transferred into a leaching tank containing water and sulfuric acid where magnesium oxide is leached from the elemental boron as magnesium sulfate (Reference K258).

After leaching, the contents of the leach tank are pumped to a filter where the boron cake is removed on filter plates. The filtrate is discharged to a neutralization tank, neutralized with soda ash, and then discharged to an evaporation pond (SI C-1). The boron cake is washed, dried, and milled in preparation for shipment (Reference K258).

Off-specification boron is returned to the production flow for reprocessing (Reference K357).

Between 1972 and January 1976, liquid wastes from the boron operations were discharged to the BMI ponds via the Beta Ditch (Reference K039, K347). Between January 1976 and January 1983, these wastes were discharged to lined on-site surface impoundments S-1 and P-1 (Reference K031, K037, K039, K347).

Surface Impoundment C-1 is an evaporation pond which began operation in October 1975. This lined on-site surface impoundment has received boron process neutralization tank waste solution from 1975 to present (Reference K158A).

4.10.4 Waste Stream Characterization

The waste stream generated in the production of elemental boron is a solution from the neutralization tank and is referenced as the "boron process neutralization tank waste

solution" (formerly called "boron leach liquor"). This liquid waste is generated as boron solids are filtered from the leach solution. This filtrate is acidic in nature and since 1975 has been sent to the neutralization tank where it is neutralized with soda ash prior to discharge to the C-1 surface impoundment. This neutralized waste stream is a slurry consisting of sodium carbonate, magnesium sulfate, sodium borate (Na_3BO_3) and sodium sulfate (Na_2SO_4) (Reference CA017).

Boron process neutralization tank waste solution from the elemental boron production leach tank was disposed from January 1976 to January 1983 to surface impoundments S-1 and P-1. SI C-1 has received this waste stream since 1975 (Reference K031, K083, K347). A review of Figure 4.10.1 reveals that the waste stream consisted of boron, magnesium sulfate (MgSO_4), neutralized sulfuric acid, neutralized boric acid, and water (Reference K117, K258).

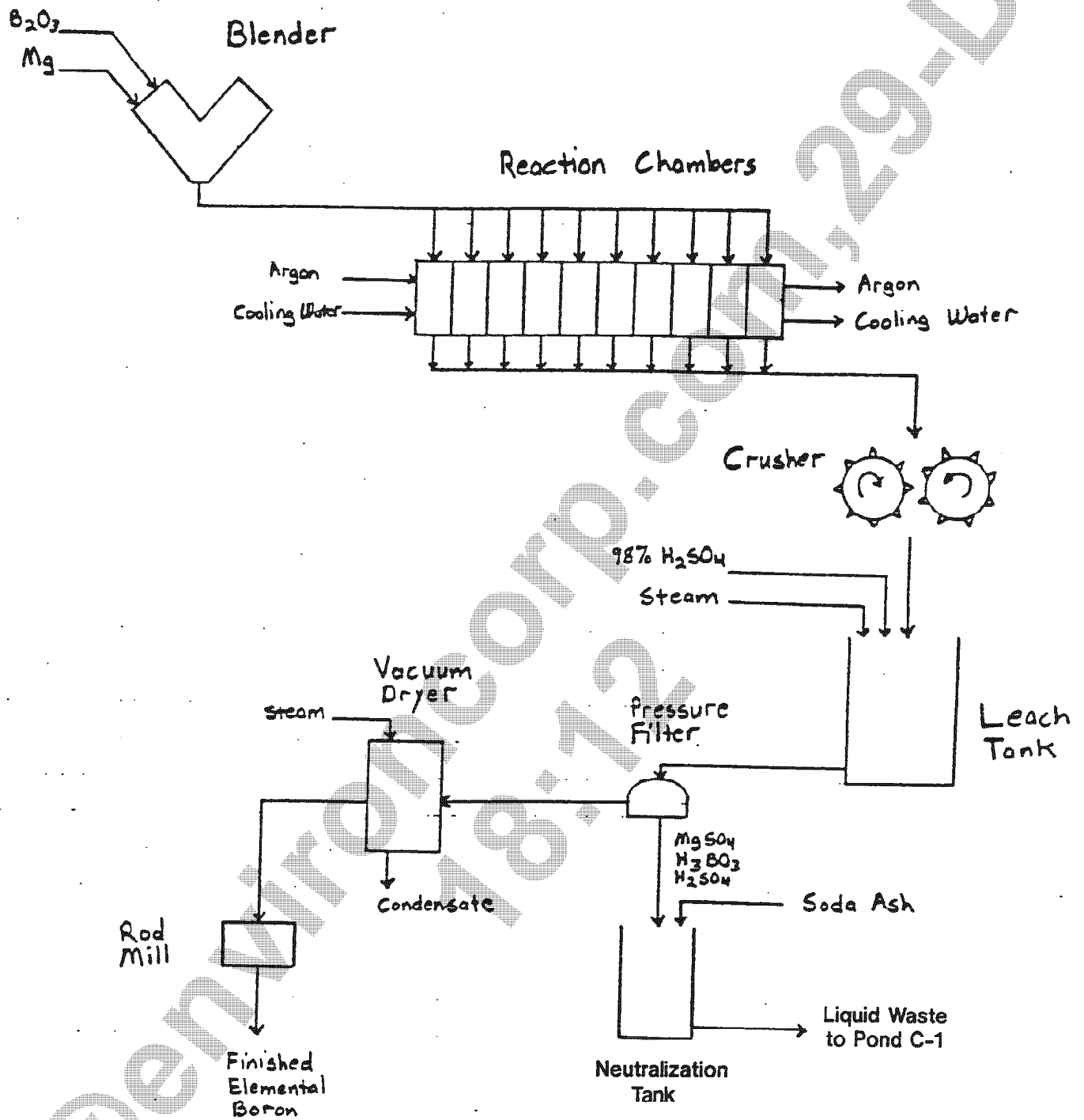

Modified after flow diagram provided by KMCC. Reference DOC #K258; K117.

FIGURE 4.10.1
ELEMENTAL BORON PROCESS
FLOW DIAGRAM

4.11 Boron Trichloride Process (Unit 5)

4.11.1 General Description

Boron trichloride has been produced at the KMCC Henderson, Nevada site since 1972/1973 in Unit 5. Boron trichloride is a gas at ambient conditions and is typically handled as a liquid in pressurized containers. Table 4.11.1 summarizes the amount of boron trichloride produced as a finished product.

TABLE 4.11.1
BORON TRICHLORIDE PRODUCTION - POUNDS
(Reference K176)

<u>Year</u>	<u>Boron Trichloride</u>
1972	0
1973	342,257
1974	424,189
1975	449,575
1976	398,758
1977	668,399
1978	437,657
1979	476,939
1980	403,138
1981	437,658
1982	362,204
1983	472,363
1984	492,989
1985	539,319
1986	574,643
1987	482,152
1988	575,075
1989	629,316
1990	526,131

4.11.2 Raw Materials Used

The raw materials used in the production of boron trichloride include boron carbide (B₄C) and chlorine gas (Cl₂) (Reference K037, K117, K257).

4.11.3 Production Process Flow Description

The boron trichloride (BCl_3) process is shown in Figure 4.11.1.

The boron carbide is loaded into a reactor made of mild steel and an inner crucible of graphite. The boron carbide is heated when chlorine gas is introduced to the bottom of the reactor. The chemical reaction is exothermic and the reaction temperature is controlled by the chlorine feed rate. Once the reaction is completed, spent boron carbide ash (spent carbon residual) is removed by gravity flow through the bottom of the reactor. During the reaction, boron trichloride gas is continuously removed from the reactor to a condenser. The condenser is air cooled to condense metal halides and oxychlorides. Boron trichloride exits the condenser through a screen filter designed to capture entrained solids. The condenser is periodically cleaned by scraping the solid contaminants from the inner walls (Reference K257).

The boron trichloride gas is then fed to the crude distillation column to remove unreacted/reacted chlorine gas and non-condensable gases. The chlorine is recycled for later use in the boron carbide reactor. Boron trichloride gas is condensed to a liquid state at the condenser, and falls through the column to the crude reboiler. The reboiler vaporizes the boron trichloride liquid, and the vapor re-enters the crude distillation column. The condensation and vaporization of boron trichloride is repeated continuously to purify the boron trichloride. A portion of the boron trichloride is removed from the bottom of the distillation column and is fed to the refined reboiler and distillation column (Reference K257).

The refined distillation column removes silicon from the boron trichloride. Silicon is removed as silicon tetrachloride. Silicon tetrachloride (SiCl_4) has a higher boiling point than boron trichloride, and is accumulated in the refined reboiler. The boron trichloride is condensed and removed from the top of the second distillation column with a portion of the boron trichloride transferred to the boron trichloride product receiver. The remainder is sent back to the top of the refined distillation column to be reused (Reference K257).

Boron trichloride is temporarily stored in the product receiver and then transferred to a portable storage tank. Shipping cylinders are then filled with boron trichloride and shipped to customers (Reference K257).

Excess boron trichloride from the reactor and the refined distillation column is sent to a wet scrubber. The wet scrubber consists of a blower in combination with a water mist chamber which pick up the BCl_3 vapor and pass it through a water mist. The resulting water and HCl stream is recycled to the Unit 5 cooling tower for pH adjustment (Reference K357).

Off-specification boron trichloride is returned to the distillation column for reprocessing (Reference K357).

The BMI dump was used from 1972 to 1979 for disposal of the spent carbon (Reference K039). Between 1979 to present, the spent carbon waste has been sent off-site for disposal as a nonhazardous solid industrial waste (Reference K039).

Several surface impoundments were used for disposal of wastes throughout the history of the boron trichloride production. The waste streams from the boron trichloride production process result from the scrubber bottoms and spent carbon from the boron carbide reactor. This stream was discharged to the BMI ponds from 1972 to prior to January 1976. After use of the BMI ponds ceased in early January 1976, this liquid waste stream was discharged to the lined, on-site KMCC ponds, including surface impoundments S-1 and P-1. Scrubber bottom liquid wastes are currently sent to the Unit 5 cooling tower as pH control solutions for the tower (Reference K039, K056, K117, K170, K179, K347, K357).

Cooling tower blowdown and reboiler wastes were discharged to the BMI ponds from 1972 to prior to January 1976. From prior to January 1976 to present, these wastes have been discharged to the lined on-site ponds: first to P-1, then to S-1, and currently to C-1 (Reference K039, K056, K117, K170, K179, K257, K347). Discharge to S-1 and P-1 ceased prior to 1983 (Reference K357). The reviewed documents did not indicate precise dates of use for these ponds P-1, S-1, and C-1 for these discharges. Section 5.0 of this report provides further descriptions on these surface impoundments.

Halide wall solid waste and the screen filter waste are periodically scraped from the walls of the respective vessels and sluiced to Pond C-1 since 1983. Between 1983 and 1976, these wastes were sluiced to SIs P-1 and S-1. Prior to January 1976, the wastes were sluiced to the BMI ponds.

4.11.4 Waste Stream Characterization

Ash from the carbide reactor (spent carbon residue) is air classified to separate the carbon from the unreacted boron carbide. The carbide is recycled back to the reactor. From 1972 to 1979, the carbon was disposed of in the BMI dump. From 1979 to present, the carbon has been disposed of as a nonhazardous solid industrial waste in a sanitary landfill operated by Silver State Disposal in Clark County (Reference K039, K117).

High boiling compounds, mainly silicon tetrachloride, that collect in the reboilers are removed monthly and flushed to surface impoundment C-1. C-1 pond has received this material since the mid-1970s.

Scrubber liquid which contains dissolved chlorine and chlorine gas (as HC1) is stripped in the boron unit's cooling tower where it has been sent since 1972. The cooling tower blowdown and the reboiler waste streams were discharged to the BMI ponds from 1972 until prior to January 1976. Since January 1976, these wastes have been discharged to the lined, on-site surface impoundments: first to P-1, then to S-1. Discharge to SI C-1 began in 1983 and continues to the present (SWMU KMCC-011). These liquid waste streams contain sodium hexametaphosphate, neutralized sulfuric acid, manganese, sodium, sulfite and borate ions. The KMCC file documents report wastes from this area as "boron compounds" and include waste streams generated by the elemental boron, boron trichloride and boron tribromide production processes (Reference K039, K056, K117, K170, K179, K257, K347).

The halide wall solid waste and the screen filter waste are chiefly a solid silicate scale suspended in water used to sluice the suspension to SI C-1.

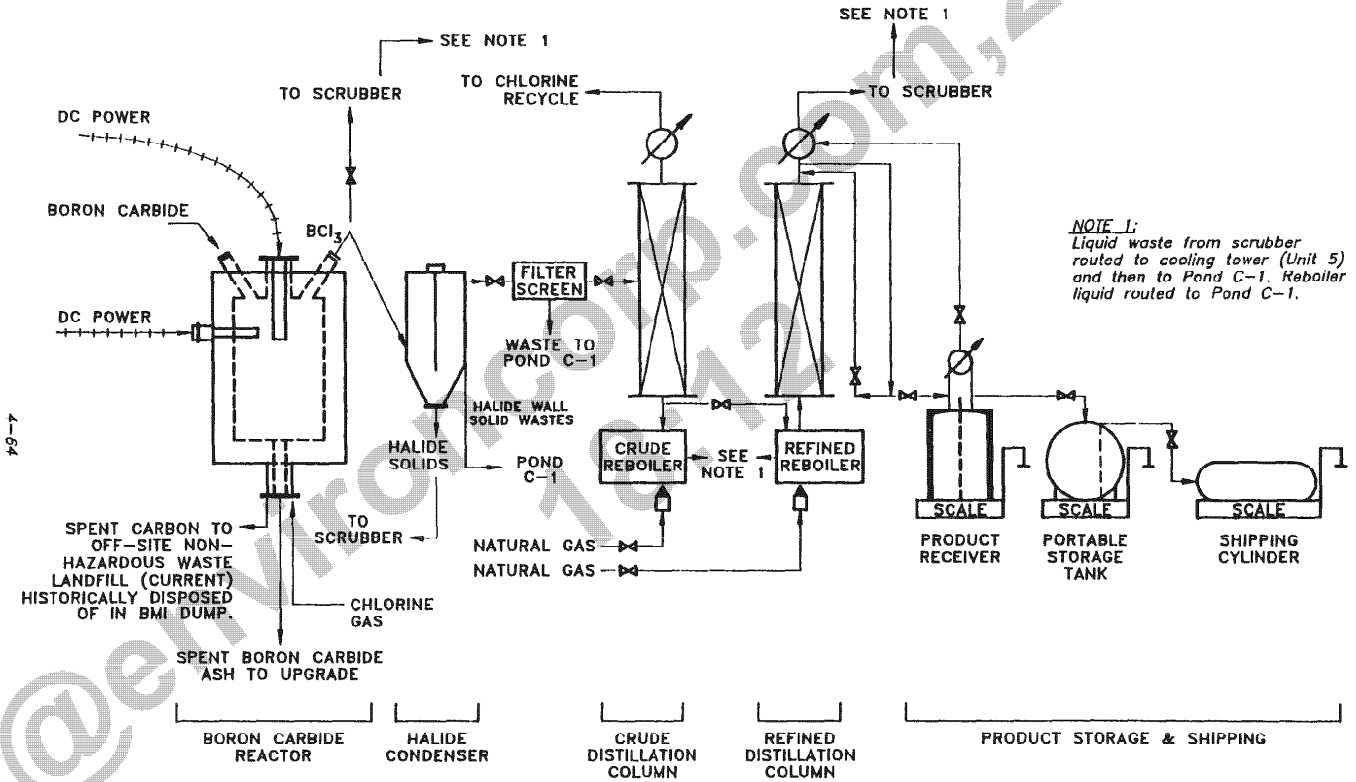

NOTE 1:
Liquid waste from scrubber routed to cooling tower (Unit 5) and then to Pond C-1. Reboiler liquid routed to Pond C-1.

FIGURE 4.11.1
BORON TRICHLORIDE PROCESS
FLOW DIAGRAM

Modified after flow diagram provided by KMCC. Reference DOC #K257, K39, K117.

4-64

31-135909-004

KMC DR
04-008554

4.12 Boron Tribromide Process (Unit 5)

4.12.1 General Description

Boron tribromide has been produced at the KMCC Henderson, Nevada site since 1972/1973 in Unit 5. Boron tribromide is a gas at ambient conditions and is typically handled as a liquid in pressurized containers. Table 4.12.1 summarizes the amount of boron tribromide produced as a finished product.

TABLE 4.12.1
BORON TRIBROMIDE PRODUCTION - POUNDS
(Reference K176)

<u>Year</u>	<u>Boron Tribromide</u>
1972	0
1973	2,303
1974	1,014
1975	224
1976	(30) ^(*)
1977	(15) ^(*)
1978	1,830
1979	10,436
1980	11,092
1981	6,393
1982	21,164
1983	25,105
1984	22,788
1985	9,245
1986	71
1987	6,619
1988	4,432
1989	329
1990	(203) ^(*)

Note:

(*) Negative number: an accounting procedure to adjust the total finished amount of product which is less than the cumulative quantity production records indicate was manufactured during previous years of production.

4.12.2 Raw Materials Used

The raw materials used in the production of boron tribromide include boron carbide (B₄C), and bromine gas (Br₂) (Reference K037, K117, K257).

4.12.3 Production Process Flow Description

The boron tribromide (BBr_3) process is shown on Figure 4.12.1. The same equipment used for the production of boron trichloride is used for boron tribromide production. The process flow description is identical with the replacement of bromine gas (Br_2) in the boron tribromide process wherever chlorine gas (Cl_2) occurs in the boron trichloride process.

4.12.4 Waste Stream Characterization

The waste streams for the boron tribromide process are very similar to those described in Section 4.11.4 for the boron trichloride process. The primary difference is the formation of silicon tetrabromide rather than silicon tetrachloride. The KMCC file document reports wastes from this area as "boron compounds" and include waste streams generated by the elemental boron, boron trichloride, and boron tribromide production processes (Reference K039, K117, K170, K179, K257).

4-67

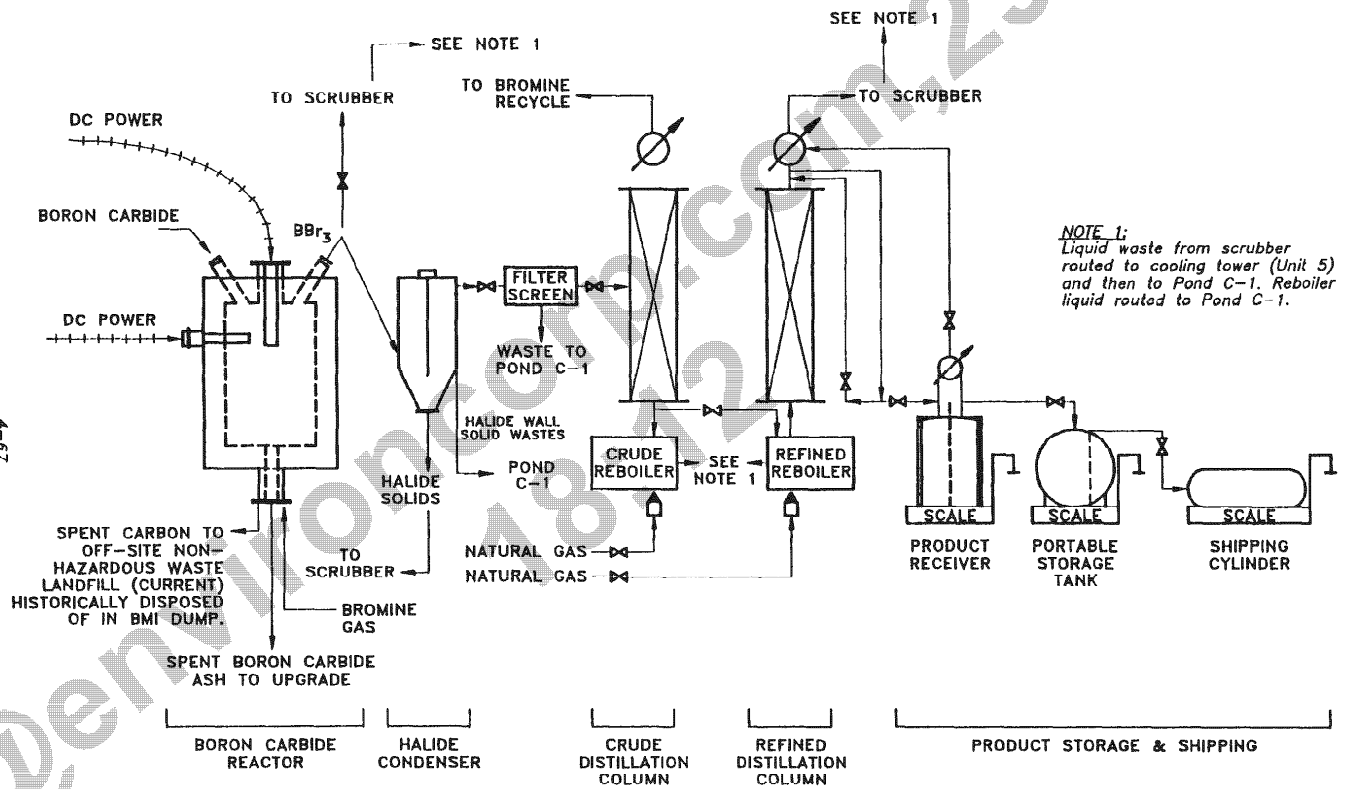

NOTE 1:
Liquid waste from scrubber routed to cooling tower (Unit 5) and then to Pond C-1. Reboiler liquid routed to Pond C-1.

FIGURE 4.12.1
BORON TRIBROMIDE PROCESS
FLOW DIAGRAM

Modified after flow diagram provided by KMCC. Reference DOC #K257, K39, K117.

31-135909-004

KMCC DR
04-008557

4.13 Steam Plant Process

4.13.1 General Description

The steam plant is located approximately 1320 feet north of Unit 4. The steam plant provides steam to the entire KMCC Henderson Complex. The users of this steam are the Chlorate, Electrolytic Manganese Dioxide (EMD), Boron, Wastewater Treatment (Vapor Recompression Unit), Ammonium Perchlorate and Steam Plants. The steam is used mainly for process heating and vacuum ejectors. The boiler feed water pumps in the steam plant are driven by steam turbines (Reference K338).

Steam is distributed through two (2) branch headers off the main steam header. One branch feeds the Chlorate, Manganese, Boron, and Wastewater Treatment Plants and the other branch feeds the Ammonium Perchlorate Plant area. The largest steam users are the Electrolyte Manganese Dioxide (EMD) and Ammonium Perchlorate Plants, which normally consume approximately 86 percent of the entire steam demand. The Steam Plant uses approximately 6 to 7 percent of the total steam internally for its own process. The branch header feeding the Chlorate, Manganese, Boron, and Wastewater Treatment Plants (Vapor Recompression Unit) is cross-tied with a feed header from the Pioneer Chlor Alkali Steam Plant. This cross-tie allows these areas to operate when steam is not available from the KMCC Steam Plant (Reference K338).

4.13.2 Raw Materials Used

The following raw materials are used at the steam plant to condition the water, remove impurities, and/or produce steam (Reference K338, CA017):

- o water;
- o natural gas;
- o fuel oil;
- o lime or NaOH;
- o caustic;
- o coagulant;
- o sodium sulfite (Nalco 1720);
- o a chelant (Nalco 1745); and
- o anti-foam (Nalco 750).

4.13.3 Production Process Flow Description

The Steam Plant has five process areas. These are the Water Softening, Chemical Treatment, Steam Generation, Effluents Collection, and Utilities areas. These areas are described below.

Steam Generation Area

Three boilers are used to generate steam in the Steam Plant. They receive feed water from a common header and discharge steam into a common header. Boilers No. 1 and 2 are set up to burn either natural gas or fuel oil whereas Boiler No. 3 burns natural gas only (Reference K338).

Effluent Collection Area

Effluents from the Steam Plant are processed through the Wastewater Treatment Plant (Vapor Recompression Unit). The effluents involved are the boiler blowdowns, the backwash and regeneration water from the secondary and A.P. water softeners, the sludge bed blowdown from the hot process softener, and miscellaneous pump seal flushes. These are collected in the Effluents Tank and pumped into the wastewater feed header which is routed to the wastewater surge/settling ponds (WC-1 and WC-2). From there, wastewaters are pumped up to the Vapor Recompression Unit for water recovery. Total effluents from the Wastewater Treatment Plant (Vapor Recompression Unit) average 5-10 gallons per minute which is discharged back to WC-1 and WC-2 (Reference K338).

Utilities Areas

Air is supplied to the plant from a compressor that also provides air to the A.P. Plant. Electrical power is supplied from two separate feeder lines. This allows a switch over if one feeder is lost to keep the plant generating. Natural gas is supplied from a Southwest Gas header. Feed water comes from three sources. The main source comes in from the facility raw water loop. Water is also obtained from the return of condensed steam and from distillate from the Vapor Recompression Unit. Condensate return is usually about 50 percent of the feed water requirement (Reference K338).

Water Softening Area

The boiler feed water must be de-aerated to remove dissolved oxygen and must be softened to remove dissolved constituents such as calcium and magnesium (Reference K338).

Softening is accomplished in two stages. The first is hot process softening which is conducted in a single vessel. In its upper section, steam heats the feed water and a caustic and coagulant are added. The resulting changes in temperature and alkalinity cause calcium and magnesium solids to precipitate out. The coagulant added helps the solids agglomerate thus aiding settling and stabilizing of the bed solids. The bed solids act as seed particles helping more solids to precipitate. After the water exits the bed, it is scrubbed with steam in a de-aerator section to remove dissolved oxygen. The de-aerated water then flows on to the second stage of treatment (Reference K338).

Following the hot process softener is a zeolite secondary softener which further removes dissolved constituents by absorption on an ion exchange resin bed. This softener typically reduces the total hardness to less than 1 ppm (Reference K338).

Chemical Treatment Area

Some chemical treatment is also required beyond softening and deoxygenation. Sodium sulfite (Nalco 1720) is added to the feed water as it leaves the hot process softener to remove the last traces of oxygen. A chelant (Nalco 1745) is also added to serve as a dispersant which ties up the remaining solids so they cannot deposit as scale in the steam drum. The dispersant is added along with an anti-foam (Nalco 750) just after the Zeolite Softeners. A small bleed stream is blown down off the boilers to keep the solids within a range for which the treatment chemicals will remain effective (Reference K338).

4.13.4 Waste Stream Characterization

Wastes associated with the steam plant operations result from the following activities (Reference K031, K117, K338):

- o boiler blowdowns;
- o backwash and regeneration water from the secondary and A.P. softeners;

- o sludge bed blowdown from the hot process softener;
- o brine from vapor recompression unit; and
- o miscellaneous pump seal flushes.

These wastewater streams were historically routed to surface impoundment C-1 (Reference K031, K117, K158A). The wastewater contains elevated concentrations of sodium, calcium, and magnesium (Reference K158A, K338). Since approximately 1989, this wastewater has been routed to surface impoundments WC-1 and/or WC-2. This wastewater is then processed through a Vapor Recompression Unit to produce clean water for cooling and process use (Reference K305, K320).

Order@enviroincorp.com, 29-Dec-18, 12



5.0 WASTE MANAGEMENT UNITS AND AREAS

General

This section addresses Solid Waste Management Units (SWMUs) identified during document review and site reconnaissance activities. Thirty-one (31) SWMUs were identified and their characteristics are presented in the following subsections. Each subsection provides the following information:

- o unit/area design and operational history;
- o unit/area waste characteristics;
- o regulatory status of unit;
- o waste constituent migration pathways;
- o evidence of releases and potential environmental impacts; and
- o analysis of release prevention or mitigation measures.

An index (listing) of the 31 SWMUs identified during this assessment is provided in Appendix D.

5.1 "Process Hardware" Storage Area Between Units 1 and 2

5.1.1 Unit/Area Design and Operational History

The process hardware storage area (SWMU KMCC-001) is located on the east side of the asphalt and concrete paved area between Units 1 and 2. This storage area abuts the west side of Unit 2 and extends from a line approximately even with the southerly building boundary to the building wall north of the area (Reference Map 1). The area is approximately 210 feet long (north-south) by 50 feet wide (east-west) and is within the fenced and guarded KMCC facility (Reference K161). The area is flat, with a slight drainage gradient to the west and south towards a storm drain in the center of Sixth Street.

This area has been used to store process hardware since November 1989. Use of SWMU KMCC-001 probably began in approximately 1980, when Kerr-McGee began

to review its material disposal options in relation to appropriate solid waste requirements. Specific area use was not documented prior to 1989 (Reference K357). The process "hardware" delivered to this storage area consists of scrap metal parts and equipment from the decommissioning of the former sodium chlorate process in Units 4 and 5. Parts, tanks, and other equipment destined for this area are rinsed or otherwise decontaminated prior to delivery. The parts are temporarily stored in this area until sold as scrap metal (Reference K357).

This SWMU was reviewed during a site reconnaissance (SR) on August 19, 1991. On that day, only one titanium tank was present and the storage area exhibited signs of good housekeeping practices. Both the stored tank and the storage area did not appear to have residual process materials. The asphalt and concrete surfaces appeared weathered and showed signs of cracking and deterioration associated with age. The following features were noted within this SWMU:

- o seams were present between the asphalt and concrete and within the concrete area;
- o a soil-filled metal frame was present flush with surface grade and located approximately 12 feet west of the west wall of Unit 2 and 10 feet south of the northern edge of the concrete. This feature may represent a former drain or sump;
- o a diamond plate covered feature was observed flush with surface grade due east of the soil-filled metal frame and against the west wall of Unit 2;
- o a diamond plate covered feature was observed flush with surface grade approximately 12 feet north of the northern edge of the concrete pad and in the corner against the Unit 2 wall; and
- o a relatively small amount of sodium chloride had overflowed from a Unit 2 door onto the storage area surface. Sodium chloride is a raw material used in the chlorate process and is stored within Unit 2.

5.1.2 Unit/Area Waste Characteristics

The specific waste at this location is cleaned scrap equipment comprised of steel, titanium, brass, copper, stainless steel, and/or other various common metals. The scrap is classified as nonhazardous solid industrial waste destined for recycling.

5.1.3 Regulatory Status of Unit

Kleinfelder did not find documentation regarding any special regulatory status for this area. This SWMU appeared to be operated in conformance with appropriate operating practices for nonhazardous solid waste destined for recycling.

5.1.4 Waste Constituent Migration Pathways

The scrap equipment is rinsed or otherwise decontaminated prior to delivery to this storage area; therefore, the possibility for residual hazardous constituents to migrate and impact the surrounding environment is unlikely.

5.1.5 Evidence of Releases and Potential Environmental Impacts

Indications of releases from this SWMU were not evident during the August 19, 1991 SR. Documentation of historic releases from this SWMU was not found during this study.

5.1.6 Analysis of Release Prevention or Mitigation Measures

Because the scrap equipment is rinsed or otherwise decontaminated prior to delivery to this storage area, the concentration of residual hazardous constituents would be low, if detectable. Releases of residual hazardous constituents from cleaned scrap equipment should not have a measurable environmental impact.

5.2 Trash Storage Area North of Units 1 and 2

5.2.1 Unit/Area Design and Operational History

The trash storage area north of Units 1 and 2 (SWMU KMCC-002) is comprised of two asphalt surfaced areas separated by Sixth Street, a 20-foot-wide asphalt road (Reference Map 2). The eastern storage area is approximately 65 by 100 feet and the western storage area is approximately 65 by 50 feet. These storage areas are located within the fenced and guarded KMCC facility and appear capable of holding more than 2,000 drums (Reference SR, August 19, 1991).

This SWMU has been in use since approximately March 1980 following closure of the BMI Landfill. Common trash from the sodium chlorate and sodium perchlorate

process areas are segregated, delivered to this storage area in 55-gallon drums, and inspected prior to disposal. The drums are sealed, labeled as nonhazardous waste, and shipped to the U.S. Ecology, Inc. Landfill in Beatty, Nevada. Disposal in the Beatty landfill is precautionary because a fire hazard may occur if the common trash is contaminated with sufficient chlorates or perchlorates from the production area (Reference K357).

An SR was conducted on August 19, 1991. On this day, only the eastern storage area was being utilized. Thirty-three, 55-gallon drums were neatly arranged on the eastern storage pad. Several drums were placed on the soil adjacent to the asphalt. Thirty of the drums had lids securely in place. One closed bag of Tyveks was observed on the asphalt adjacent to the drums.

The asphalt surfaces appeared weathered and showed signs of cracking and deterioration associated with age. Neither of these storage areas were equipped with berms or other run-on/run-off control features. Surface water run-on to this SWMU could occur from the very slightly elevated soils in the area to the east of the two storage areas. Run-off from this SWMU would flow into a storm drain to the north of this area in the center of Sixth Street and ultimately drain to the Beta Ditch through NPDES monitoring equipment (Reference K178).

5.2.2 Unit/Area Waste Characteristics

The stored wastes are composed of domestic trash such as paper, Tyveks, gloves and other items which may have been contaminated with chlorates or perchlorates from within process areas. These wastes are received and stored in sealable 55-gallon drums.

5.2.3 Regulatory Status of Unit

Kleinfelder did not find documentation regarding any special regulatory status for this area. This SWMU appeared to be operated in conformance with good operating practices for the nonhazardous industrial solid waste.

5.2.4 Waste Constituent Migration Pathways

Good housekeeping practices were observed at this SWMU during an August 19, 1991 SR. Because only trace concentrations of residual process materials might be present, these would be insufficient to provide a source for environmental impact.

5.2.5 Evidence of Releases and Potential Environmental Impacts

Indications of releases from this SWMU were not evident during the August 19, 1991 SR.

5.2.6 Analysis of Release Prevention or Mitigation Measures

The method of release prevention used by KMCC is the containerization of trash before delivery to this storage area. The present good housekeeping practices reduce the possibility for trace amounts of chlorates and perchlorates to accumulate on the asphalt surface or migrate into the environment.

5.3 PCB Storage Area - Unit 2

5.3.1 Unit/Area Design and Operational History

The polychlorinated biphenyl (PCB) storage area (SWMU KMCC-003) is located within the northern portions of Unit 2 within the fenced and guarded KMCC facility (Reference Map 3). This storage area consists of three, approximately 12 foot by 15 foot vaults with floors that are approximately 12 inches lower than the surrounding area. The concrete vault walls are approximately 8 inches thick. The concrete vault floors are covered with black, 6 mil. plastic sheeting to reduce the possibility of PCB oil spills reaching the concrete floor. Warning signs indicating a PCB storage area are posted outside the door of the vaults and other warning signs are posted on the drums and transformers containing PCB materials when these are present (Reference SR, August 19, 1991).

This vault area had been reserved as a PCB storage area since 1978. Documents reflect use of this area for PCB storage since 1980. Transformers containing PCB cooling oils are occasionally transferred to the vaults where the used oil may be drained from the transformers and transferred to 55-gallon drums. Additionally, other wastes containing

PCBs are stored in 55-gallon drums in this area. These wastes include rags, oil sorb, and concrete from maintenance and clean up of PCB containing transformers. The used PCB containing oil and other PCB containing wastes are stored in the vaults until shipped for disposal (Reference K357, K260, K261).

An SR was conducted on August 19, 1991. On the day of the SR, there were no transformers stored in the vaults. Used PCB containing oil and other wastes containing PCBs were stored in drums in the two westernmost vaults. Indications of spills or leaks of oil on the concrete floor or plastic sheeting were not evident. PCB warning signs were observed posted on the outside of the door and on the drums.

Surface run-on to this SWMU is unlikely as the area is indoors and the entrance way floor is slightly elevated compared to the outside surface. Run-off from within the vaults is unlikely due to the location of the SWMU within a building and the sunken floor design.

5.3.2 Unit/Area Waste Characteristics

The specific materials handled in this area are transformers containing polychlorinated biphenyl (PCB) cooling oil, drums of PCB containing waste oil from transformer servicing, and drums of solid waste from maintenance activities (i.e. PCB contaminated rags, oil sorb, and concrete).

The migration and dispersal characteristics of transformer cooling fluid is similar to that of high temperature hydraulic oil. Dispersion of the oil would be by spillage to the surface of the concrete; the migration mechanism would be capillary action.

5.3.3 Regulatory Status of Unit

This SWMU is regulated under 40 CFR Part 761 regarding PCB material generation, inspections, removals, and liquid disposal (Reference K260). KMCC submits annual PCB Inspection Reports to the U.S. EPA and NDEP. Inspection reports were reviewed for the years 1978, 1980, 1988, 1989, and 1990 (Reference K260, K261, UE016, UE021).

The U.S. EPA conducted a TSCA Section 6 PCB inspection on January 24, 1989. With regard to the PCB storage area, the inspection report indicated "*the drums were*

properly stored in an area conforming to the permanent storage requirements. Monthly inspections of all in-service and equipment stored for reuse had been conducted since 1981 (Attachment 5)...Annual documents had been maintained since 1978. They appeared to be in order (Attachment 8)." (Reference UE016).

5.3.4 Waste Constituent Migration Pathways

The potential migration pathway in this area is limited by the plastic sheeting and underlying concrete vault floors and walls. The pathway is restricted to the surface of the concrete except in areas where cracks or open seams may be present. If cracks or open seams are present and PCB containing oil migrated through these openings, migration to soil could occur by capillary action.

5.3.5 Evidence of Releases and Potential Environmental Impacts

Obvious indications of releases from this SWMU were not evident during the August 19, 1991 SR. (Documentation of historic releases from this SWMU was not found during this study.)

5.3.6 Analysis of Release Prevention or Mitigation Measures

The heavy duty concrete construction and the sunken floor design of the vault provides an effective means for containment and control of potential releases to the environment. The use of plastic sheeting as a liner on the surface of the concrete vault floor provides for additional control of potential releases of PCB containing oil. Should a spill occur within the containment area, the plastic sheeting is easily removed and properly disposed, thus limiting impacts to the concrete surfaces.

This SWMU appeared to be operated in accordance with good operating practices and applicable requirements of 40 CFR, Part 761 (Reference UE016; SR, August 19, 1981).

5.4 Hazardous Waste Storage Area North of Unit 2

5.4.1 Unit/Area Design and Operational History

This hazardous waste storage area (SWMU KMCC-004) consists of four segregated storage areas on concrete pads located approximately 40 feet north of Unit 2 and 40

feet west of Seventh Street within the fenced and guarded KMCC facility (Reference Map 4). The overall size of the SWMU is approximately 65 feet by 15 feet. Three of the concrete storage areas are equipped with four-inch high by five-inch thick concrete containment berms. The fourth storage area, located at the northern end of this SWMU, is unbermed and used to store empty drums on pallets. The southern three bermed storage areas are posted with advisory signs designating the type of wastes stored in each area. The waste types stored in these areas are: (1) waste oil and miscellaneous compatible wastes, (2) flammable and miscellaneous compatible wastes, (3) bases and miscellaneous compatible wastes, and (4) acids and miscellaneous compatible wastes. The wastes are delivered to the SWMU in drums and placed in the appropriate area for that type of waste (Reference SR, August 19, 1991).

This storage area was constructed specifically for RCRA compliance, and was in use by 1983. Since the material managed was in drums, construction was believed to be a concrete pad on a crushed rock base. Documents regarding or detailing engineering or construction considerations were not found (Reference K357).

This storage area was observed during an August 19, 1991 SR. At that time, drums were stored within the four storage areas. Waste designation signs were in place and the stored wastes were in the appropriate areas.

The concrete berms and floors of the containment areas had some minor hairline cracks. One seam was observed in the concrete floor of the center bermed unit. This appears to be the seam between the two sections of concrete pad that comprise the overall SWMU. The berms appeared to be poured-in-place and to be an integral part of the floor. The concrete floor generally appeared to be intact, however, pitting was obvious in some areas and some etching of the concrete floor was observed in the area where acid wastes were stored. The SWMU is surrounded by a gravel surface.

Surface water run-on and run-off is controlled by the berms. In the event that more than four inches of storm water would accumulate, run-off from this SWMU would flow to the northeast toward the storm drain at the intersection of Avenue G and Seventh Street. However, this storm drain is bermed by four-inch high berms to reduce the possibility of water-dispersed wastes entering the system. Surface water

run-off entering the storm drain system in this portion of the facility would drain to the Beta Ditch through NPDES monitoring equipment (Reference K178).

5.4.2 Unit/Area Waste Characteristics

The wastes handled at this SWMU consist of used oil, flammable wastes, bases, acids, and miscellaneous compatible wastes. These wastes are stored in 55-gallon drums.

5.4.3 Regulatory Status of Unit

This SWMU would be regulated under 40 CFR Part 265 Subpart I - Use and Management of Containers and Part 262 Subpart C - Pre-Transport Requirements.

During the August 19, 1991 SR, the drums present at this SWMU were observed to be physically segregated from incompatible wastes, and labeled as "hazardous waste". The drums appeared to be in good condition.

5.4.4 Waste Constituent Migration Pathways

If a spill occurred, the potential pathway is the concrete surface within a bermed area. Spill volumes within the bermed area typically would be limited to drum quantities and be contained within the bermed area. If spills occurred and were left uncollected, migration may occur through cracks in the concrete containment pad. Migration to the underlying soil would be possible by capillary action. Spills outside this SWMU would disperse to the gravel and underlying soil (Reference SR, August 19, 1991).

5.4.5 Evidence of Releases and Potential Environmental Impacts

The only observed evidence of releases outside of the bermed area was a small oil stained area (measuring approximately one foot in diameter) south of the waste oil storage area. Other evidence of spills or releases potentially attributable to this SWMU was not observed (Reference SR, August 19, 1991). Documentation of historic releases from this SWMU was not found during this study.

5.4.6 Analysis of Release Prevention or Mitigation Measures

The release prevention methods employed include the containerization of wastes in drums and the storage of these drums within the concrete bermed storage areas. The

containment areas appeared adequate for the number of drums handled by this SWMU. From the orderly manner in which the drums were observed to be stored and the generally good housekeeping of this SWMU, it appears that the release prevention methods are satisfactory.

5.5 Sodium Chlorate Filter Cake Holding Area North of Unit 3

5.5.1 Unit/Area Design and Operational History

This SWMU is a designated hazardous waste drying and storage area (SWMU KMCC-005) located approximately 30 feet north of Unit 3 and 20 feet west of Eighth Street, within the fenced and guarded KMCC facility (Reference Map 5). This SWMU was constructed in June 1991 and replaces a bermed concrete pad which was used for the same purpose since approximately late 1982 (Reference K345). The new drying and storage area was built over the same location as the former drying pad (Reference SR, August 19, 1991). Demolition debris associated with the original concrete pad was disposed of at U.S. Ecology in Beatty, Nevada. The debris consisted of concrete and minor amounts of sub-base and soil and constituted approximately 42 tons of material (Reference K345, K373).

This SWMU is approximately 36 feet long (north-south) and 18 feet wide (east-west) and is constructed of concrete. The concrete floor of the holding area is approximately 18 inches above the surrounding asphalt paved area and slopes toward the rear wall. The three vertical walls of the holding area are constructed of concrete and vary between approximately one and one-half to three feet in height above the holding area floor. Access to the elevated holding area is up a concrete ramp which is the same width as the holding area. The concrete ramp is approximately 20 feet long (Reference K345).

Liquids which drain from the filter cakes held in this SWMU flow to the lower southwest corner and exit the holding area through a pipe and a valve into a 12-inch deep portable plastic containment bin. This containment bin is positioned within a sunken ramped and bermed concrete secondary containment area. A separate ramp

allows access by forklift to remove the portable bin when it is full and recycle the solution to the process (Reference K345; SR, August 19, 1991).

The concrete holding/drying area and the concrete secondary containment area are underlain by an HDPE liner and a leak detection system. The leak detection system consists of a four-inch diameter PVC monitoring pipe which extends to the low point of the liner. The monitoring pipe has a perforated cap at the low end to allow detection and measurement of liquids trapped by the liner (Reference K345; SR, August 19, 1991).

The operating practices in this area consist of transporting damp to wet process filter cakes from the sodium chlorate operations to this SWMU for drying. The entrained solutions in the process filter cakes contain hexavalent chromium. The cakes are placed in this holding area where they are allowed to dry. When the material is dry, it is taken by front-end loader to the hazardous waste storage area between Units 3 and 4 (SWMU KMCC-006) awaiting off-site disposal (Reference SR, August 19, 1991).

An SR was conducted on August 19, 1991. On that day, there was a small amount of filter cake in the holding area. Signs of significant deterioration or cracks were not observed. The holding area appeared adequate in size and appropriately managed for the anticipated amount of filter cake to be stored. A sign and several labels were posted at this SWMU reflecting hazardous waste storage.

Run-off from the unit is controlled by the floor sloping to the back southwest corner where precipitation run-off, as well as liquids from the cakes, flow through a pipe and valve system into a plastic containment bin. Additionally, storm drains in this general area have been retrofitted with four-inch high protective berms to reduce the possibility of water-dispersed wastes entering the system. Surface water run-on is prevented by the elevated design of the holding area. Ponding may occur against the outside concrete walls of the storage area and may enter the secondary containment area because the ramp to this area slopes down toward the plastic containment bin. Water would have to overtop the plastic containment bin and/or exceed the containment capacity to cause a release of solution from the secondary containment area.

5.5.2 Unit/Area Waste Characteristics

The material held in this area is comprised of filter cakes from the sodium chlorate operations. This material contains total chromium, a mixture of hexavalent and trivalent chromium, at concentrations that potentially could be greater than 5.0 mg/L if this material were evaluated by EP Toxicity (EP TOX) testing criteria (Reference K219, UE022). KMCC's manufacturing experience has shown that the filter cake may, at times, contain hexavalent chromium concentrations which would be expected to exceed the RCRA criteria of 5 mg/L (TCLP). KMCC has, therefore, chosen to manage the material as a hazardous waste, and dispose of it accordingly, rather than instituting a testing program for every load to assess the hexavalent chromium concentration. Since January 1990, the filter cakes originate from the mud filter, brine filter, polishing filter, and sulfate filter (Reference K259). Prior to 1990, the filter cakes originated from Sparkler and Durco filters (Reference K253). Documentation was not found regarding testing of this waste by the Toxicity Characteristic Leaching Procedure (TCLP) or EP TOX methods.

5.5.3 Regulatory Status of Unit

KMCC is proceeding with certification of this drying and storage area as a tank system for storage or treatment of hazardous waste in accordance with the facility's generator status. Upon certification and receipt of NDEP concurrence, this SWMU will be managed per 40 CFR Part 265 Subpart J - Tank Systems.

5.5.4 Waste Constituent Migration Pathways

The migration pathways are the concrete surface within the SWMU and the underlying foundation material between the concrete and the HDPE liner which serves as a part of the leak detection system. In the event of the waste spillage outside of the containment area, the migration pathway would be the asphalt and underlying soil which surrounds this area. Surface water run-off is controlled by the sloping design of the concrete floor and the berms surrounding storm drains in this area.

5.5.5 Evidence of Releases and Potential Environmental Impacts

Documentation of historic releases from this area was not found during this study.

During the August 19, 1991 SR, several minor releases of waste material (approximately one inch in diameter) were observed on the asphalt adjacent to the western side of the holding area. The asphalt surrounding this SWMU appeared well maintained and other evidence of releases were not observed.

5.5.6 Analysis of Release Prevention or Mitigation Measures

The release prevention methods employed at this SWMU include the concrete primary and the HDPE secondary containment systems. The leak detection system is monitored on a regular basis and records are maintained at the KMCC offices (Reference K357). The present good housekeeping practices further aid in reducing the possibility of releases of measurable amounts of sodium chlorate filter cake outside of the holding area.

5.6 Hazardous Waste Storage Area Between Units 3 and 4

5.6.1 Unit/Area Design and Operational History

This SWMU (KMCC-006) is a hazardous waste storage area, consisting of an eight-wheeled, semi-dump trailer. This dump trailer receives solid waste from the sodium chlorate process area (including filter cake directly from the sodium chlorate filter press when the moisture content is sufficiently low) and the sodium chlorate filter cake holding area (SWMU KMCC-005). The trailer is located within the fenced and guarded KMCC facility approximately 6 feet west of the western wall and 20 feet south of the northern wall of Unit 4 in the process area between Units 3 and 4 (Reference Map 6). This area is within the sodium chlorate production containment area which is bermed on both the north and south ends. The berms are positioned to retain fluids and solid waste within the production area. These fluids drain to a central sump system and are recycled into the process (Reference; SR, August 19, 1991).

This SWMU has been operating since early 1983 and is presently in use. Solid waste is typically delivered to the trailer by front-end loader. The trailer is hauled off-site to a

commercial hazardous waste disposal site such as U.S. Ecology, Inc. Beatty, Nevada facility (Reference K268; SR, August 19, 1991).

An SR was conducted on August 19, 1991. On that day, the trailer was unlined and contained asphalt rubble which had been removed from a demolition project in the production area. The rubble was being managed as potentially contaminated and was placed in the trailer for disposal as a hazardous waste. The area surrounding the trailer appeared well maintained.

The asphalt surface appeared intact and cracks were not noted in the vicinity of the trailer. Berms were intact and it appeared that water and waste spilled in this area would flow toward the recovery sump where liquids accumulate for recycling into the process. Surface water run-on into this area may occur from either the north or the south if the water is sufficiently deep to overtop the berms. However, run-on would be recovered by the sump system and recycled into the process stream. The containment berms appeared adequate and housekeeping conditions appeared good.

5.6.2 Unit/Area Waste Characteristics

The solid waste managed in this area is comprised of filter cakes from the sodium chlorate operations. This waste contains total chromium, a mixture of hexavalent and trivalent chromium, at concentrations that could be greater than 5.0 ppm if this material were evaluated by EP Toxicity or Toxicity Characteristic Leaching Procedure (TCLP) testing criteria (Reference K219, UE022). KMCC's manufacturing experience has shown that the filter cake may contain hexavalent chromium concentrations in excess of 5 mg/L. KMCC has, therefore, chosen to manage the material as a hazardous waste, and dispose of it accordingly, rather than instituting a testing program for every load to assess the hexavalent chromium concentration. Since January 1990, the filter cakes originate from the mud filter, brine filter, polishing filter, and sulfate filter (Reference K259). Prior to 1990, the filter cakes originated from Sparkler and Durco filters (Reference K253). Documentation was not found regarding testing of this waste by TCLP or EP TOX methods.

Containment of this waste in the lined and covered dump trailer limits the potential for

dispersion. The recycling of washdown water from within the containment area back into the process stream limits the dispersion and migration of waste accidentally spilled in this area.

5.6.3 Regulatory Status of Unit

This SWMU would be regulated under 40 CFR Part 265 Subpart I - Use and Management of Containers and Part 262 Subpart C - Pre-Transport Requirements.

5.6.4 Waste Constituent Migration Pathways

Potential pathways for migration of waste are spillage onto the asphalt surface during transport or loading to the trailer. Spillage in this area would be washed down with water, collected by the process area sump, and recycled into the process stream.

Also, filter cake waste potentially may be spilled outside of the production area during transport to and from the drying area (SWMU KMCC-005). If this type of spillage occurred, the waste would fall on the asphalt area between the two SWMUs and would be cleaned up.

5.6.5 Evidence of Releases and Potential Environmental Impacts

During the August 19, 1991 SR, several small marks of filter cake were noted on the asphalt surface adjacent to the dump trailer and within the containment area. These marks were approximately two to four inches in diameter and appeared dry.

Documentation of historic releases from this SWMU was not found during this study.

5.6.6 Analysis of Release Prevention or Mitigation Measures

The release prevention methods employed at this SWMU include the containerization of solid waste in the lined truck trailer, the secondary containment provided by the bermed and paved production area, and the recycling system. Filter cake which spills outside of the trailer during loading would fall within the containment area where it would be managed by washdown and recycling practices.

Two methods are employed to manage spillage of sodium chlorate solids during transfer to SWMU KMCC-006 from SWMU KMCC-005. First, the operator of the front-end loader does not fill the bucket completely. Second, filter cake which may spill from the bucket is swept up and placed in SWMU KMCC-006, or the spilled material is washed to the area collection sump (and recycled to the process) at the conclusion of the transfer operation (Reference K357).

5.7 Platinum Drying Unit North of Unit 4

5.7.1 Unit/Area Design and Operational History

This SWMU (KMCC-007) is a drying unit for platinum bearing by-product material. The drying unit is located approximately 80 feet north of Unit 4, within the fenced and guarded KMCC facility (Reference Map 7), and consists of an approximate 20 by 32 foot concrete-floored and concrete-bermed containment pad. The berms are approximately seven inches high and six inches thick. The bermed volume of this drying unit is approximately 14 cubic yards. The area is surrounded by metal stanchions and chains to keep traffic out. The area is surrounded by soil on the north, east, south and southwest sides and by concrete on the west and northwest sides.

This drying unit has been in use since 1983 to produce a material suitable for off-site shipment for platinum recovery and recycling. The operating practices consist of delivery of a damp process by-product material from the sodium perchlorate operations to this drying unit prior to off-site recycling. This material originates from sodium perchlorate cell bottoms and the sodium perchlorate filter press. Perchlorate cells are removed from the process line and transported to the SWMU by fork-lift. The cell "bottom" is then washed into the SWMU.

Occasionally, a moist filter cake is generated from the perchlorate filter press and is transported in a filter press hopper by fork-lift to the SWMU (Reference Doc. K347). However, typically, this filter cake is not moist and is placed directly into drums and temporarily stored prior to off-site transport.

After drying, the material is placed into drums, temporarily stored in a covered storage area located under a roof along the south side of the north wall of Unit 4. The drums are shipped as a recyclable material to an off-site precious metal recovery company for recovery of platinum (Reference K335, K336, K337).

This drying unit was in operation during an August 19, 1991 SR. On that date, the drying unit was full of material. The berms appeared intact as did portions of the floor which were exposed by scraping away the sludge. The material had several trenches cut through it to facilitate liquid drainage which aids in the drying process. The soil surrounding this drying unit showed some staining with a white crystalline substance similar to the white crystalline material within the drying unit.

There are no apparent surface water drains within the immediate area of this drying unit. Surface water would enter the surrounding area from the east, flow into or around the drying unit, and flow toward an adjacent topographically lower welding area to the southwest. Surface water entering the welding area may either pond or eventually flow into the adjacent process area (if it overtopped the containment berms) where it would be recovered. There is a storm drain in the middle of Avenue G approximately 80 feet from the drying unit, but it is bermed to prevent water from entering it.

5.7.2 Unit/Area Waste Characteristics

The specific material managed in this drying unit is a sodium perchlorate process by-product which contains recoverable amounts of platinum. This material is classed as a "recyclable material" (Reference UE006). The material contains diatomaceous earth filter media with trace amounts of platinum, chromium, sodium chloride, sodium perchlorate, sodium carbonate, and calcium carbonate (Reference K275, K278). The material is delivered to this drying unit in a semi-wet condition. As the material dries, a crystalline crust forms. This crust is occasionally broken to improve the drying process.

Since 1983, the dried material has been shipped as a hazardous waste or hazardous material due to the presence of sodium perchlorate, an oxidizer (Reference K336,

K337). Prior to 1983, the semi-wet material was burned on-site in enclosed electric drying ovens before being shipped for off-site platinum recovery (Reference K357).

5.7.3 Regulatory Status of Unit

The material is managed following the requirements of 40 CFR, Part 266, Subpart F-Recyclable Material Utilized For Precious Metal Recovery (Reference UE006).

5.7.4 Waste Constituent Migration Pathways

The potential migration pathways include liquids from the material overflowing onto adjacent surface soils and subsequent surface water transport if the unit is overtopped and spills material onto surface soil. The dominant pathway appears to be liquid overflow onto surface soils. Migration to shallow groundwater is unlikely without a continual source of liquid available to transport the waste to groundwater. Migration within the soil and into groundwater would be retarded by adsorption to the soil particles and cation exchange with clay particles.

The operating management practices for this recycling unit are such that measurable amounts of airborne migration are not likely due to the crust which forms during drying. The evaporative drying process causes chloride/chlorate/perchlorate crystalline crust to form on the sludge. This crust reduces the potential for airborne particle dispersion.

5.7.5 Evidence of Releases and Potential Environmental Impacts

Areas of white crystalline staining similar in appearance to those within the containment area were evident on the adjacent soil and concrete to the north, south, and west of the containment area on the day of the SR. The chemical constituents and characteristics of this white material were not evaluated, but the material is suspected to be sodium chloride, sodium chlorate, sodium perchlorate or a mixture of these compounds.

Documentation of historic releases from this SWMU was not found during this PR.

5.7.6 Analysis of Release Prevention or Mitigation Measures

The concrete berms and the concrete floor are the release prevention methods for this drying unit and the material containing valuable platinum. The concrete drying area may not be of adequate size or design for the current use.

5.8 Solid Waste Dumpsters

5.8.1 Unit/Area Design and Operational History

This SWMU (KMCC-008) is a trash and scrap metal collection area. The design features consist of open metal dumpsters placed on sloped, concrete paved surfaces which are separated by areas of gravel covered soil. This SWMU consists of three separate collection areas within the overall SWMU and is located approximately 200 feet east of the entrance guardhouse and just south of the southern limit of Avenue H within the fenced and guarded KMCC facility. The overall area is approximately 220 feet east-west by 70 feet north-south (Reference Map 8). Three different types of waste are handled within the SWMU: the westernmost area is for collection of recyclable scrap steel; the central area is for collection of common paper trash; and the easternmost area is for collection of recyclable stainless steel and non-ferrous metals (Reference SR, August 19, 1991).

This SWMU has been in use since February 29, 1980, and is presently in use. Prior to February 1980, paper trash wastes were burned or buried at the BMI dump (Reference K056). The elevated ramp for the scrap steel area was built in 1984. Operating practices presently in operation remain consistent with those of the past. Scrap steel and metal are washed and rinsed at their area of origin prior to transport to this SWMU. The common waste paper (trash) is periodically wet down to prevent wind dispersion and to reduce fire hazard in the event that some of the paper is contaminated with trace amounts of chlorates or perchlorates (Reference K357).

Observations during the SR on August 19, 1991 indicate good housekeeping and management practices in the area.

5.8.2 Unit/Area Waste Characteristics

The specific wastes delivered to this SWMU are scrap metals, both ferrous and non-ferrous, and common paper trash. Ferrous metals consist of steel and stainless steel, and non-ferrous metals typically consist of copper, brass, and insulated copper wire. The metals originate from various parts of the plant and are washed and rinsed before storage at this SWMU prior to disposal by a metal recycler. The common waste paper originates from the administration building and other areas where such trash is produced. These wastes are classified as nonhazardous solid waste.

Because the scrap material is washed prior to delivery to this SWMU, the concentration of hazardous chemical constituents on scrap steel and scrap metal are low, if present at all. The migration and dispersal potential of the scrap materials is low. The potential for wind dispersal of paper trash is reduced through application of preventive measures including periodic wetting.

5.8.3 Regulatory Status of Unit

Kleinfelder did not find documentation regarding any special regulatory status for this area. This SWMU appeared to be operated in conformance with good operating practices for nonhazardous solid waste.

5.8.4 Waste Constituent Migration Pathways

The potential migration pathways are the air for wind-borne paper trash and the concrete or soil surface for the scrap metal. The potential for migration and dispersal of scrap steel, scrap metal and common waste paper from this area is considered low.

5.8.5 Evidence of Releases and Potential Environmental Impacts

Kleinfelder did not observe releases of contaminants at the site. The pads and surrounding soil were generally free of solid waste or litter (Reference SR, August 19, 1991). Documentation of historic releases from this SWMU was not found during this study.

5.8.6 Analysis of Release Prevention or Mitigation Measures

Due to the nature of the waste handled here, releases would not have a measurable environmental impact. Possible release of paper trash from the common trash dumpster is mitigated by periodically wetting the trash down with water. This also has the advantage of reducing the risk of fire due to possible contamination by flammable substances.

5.9 Manganese Tailings Area .

5.9.1 Unit/Area Design and Operational History

The manganese tailings area (SWMU KMCC-009) is located near the eastern central portion of the KMCC property, directly north of the manganese dioxide leach plant and adjacent to the eastern property line (reference Map 9). This area is within the fenced and guarded KMCC facility and includes both the generation area (the tailings filter) and the disposal area (the nonhazardous manganese tailings pile). Manganese tailings have been placed in this area since beneficiation of manganese dioxide ore was initiated by WECCO in 1951 (Reference K037, K039).

Prior to 1975, tailings from the beneficiation of manganese dioxide ores were sluiced to unlined surface impoundments/leach beds at the current location of the tailings pile (Reference K037, K039, K056). The sluicing water either evaporated or percolated leaving the solids behind. Filtering of the manganese tailings began in February 1975 and yielded a semi-dry, solid filter cake waste (Reference K056, UE030). Since February 1975, this filter cake (referred to as manganese tailings material) has been landfilled on top of the same area previously used as leach beds (Reference K037, K039).

The manganese tailings are dewatered by a rotating drum filter that processes material from the Leach Plant operation. The dewatered tailings drop onto a concrete pad below the filter. Once enough material has accumulated on the pad, the tailings are transported (typically by front-end loader) to the nearby manganese tailings pile area for disposal (Reference SR, August 19, 1991).

The manganese tailings pile is periodically graded to allow for directed drainage of storm water. The tailings pile is highest along the north-central portion and slopes gently to moderately to the east, south, and west. The northern limit of the tailings pile is marked by an abrupt slope to the north. A storm water run-off diversion ditch is present at the base of the northern limit of the tailings pile. This drainage originates mid-distance along the eastern extent of the tailings pile and extends along the base of the northern limit of the tailings pile to an NPDES monitoring point (outfall #003) near the northwest corner of the tailings area. Another drainage along the western extent of the tailings area meets the aforementioned diversion drainage at this NPDES monitoring point (Reference SR, August 19, 1991).

An SR of the SWMU was conducted on August 19, 1991. On that day, the tailings pile appeared recently graded and the area appeared well maintained.

5.9.2 Unit/Area Waste Characteristics

The manganese tailings deposited in this area arrive as a semi-dry solid filter cake. This cake contains manganese dioxide ore tailings which are acid insoluble, and also contain trace heavy metal sulfides, silica, paraffin wax and calcium sulfate (Reference K037, K137). The tailings were analyzed by EP Toxicity testing procedures in 1979 and 1985 and by TCLP methods in 1990. Analytical results from both methods reveal nonhazardous concentrations of the eight heavy metals evaluated by these tests. KMCC has classified this beneficiation waste material as nonhazardous (Reference K147, K179, K264, K319, UE065).

Dispersion characteristics of the tailings material are controlled chiefly by moisture content. If the tailings become sufficiently dry, winds can transport this material. If the tailings become sufficiently wet, either by precipitation or surface water run-on to this area, the tailings material can be dispersed along the drainage channels. Leachate generation and migration to the underlying soils and eventually to the near surface groundwater may occur with sufficient precipitation or surface water run-on and time.

5.9.3 Regulatory Status of Unit

Disposal of manganese tailing is regulated by the NDEP. KMCC operates the manganese tailings pile under a May 15, 1985 authorization from the NDEP (Reference

K147, K343). This authorization approved the opening of the manganese dioxide solid waste landfill. The approval was based on Kerr-McGee's requests of September 24, 1984 and March 7, 1985 (Reference K111) which detailed the proposed location, materials to be landfilled, and included an EP TOX analysis of manganese dioxide tailings. The NDEP authorization for this waste pile allows the co-disposal of some demolition debris from the KMCC facility (Reference K111). Discharge of surface water run-off is regulated by KMCC's NPDES permit issued by the NDEP in 1988 (Reference K158A). No citations or violations pertaining to the manganese dioxide waste pile were found during this study.

5.9.4 Waste Constituent Migration Pathways

The migration pathways for manganese tailings includes the air and surface water. Additionally, leachate could form and migrate through soil to groundwater.

Migration via the air pathway occurs by airborne transport of dried particulate matter due to wind. Surface water run-off, as a result of precipitation or surface water run-on, would be intercepted by a diversion ditch on the north and east sides of the landfill, drain through an NPDES monitoring station (Outfall #003), and eventually exit the site via the Beta Ditch. Water which percolates through the tailings area may carry soluble constituents into the underlying soil. Sufficient infiltration, available water, and time would be required to complete the migration pathway to the shallow groundwater. The manganese dioxide tailings have been analyzed by both EP Tox and TCLP methods. Both analyses have demonstrated the nonhazardous nature and low leachability potential of the waste stream. Qualitative evaluation of the total waste stream indicates that calcium sulfate is the only potentially water soluble constituent in appreciable quantities. However, the water solubility of calcium sulfate is rather low. Additionally, neither calcium nor sulfate are hazardous substances.

Disposal of manganese dioxide slurry to leach beds in the same area prior to 1975 depended upon evaporation and percolation for dewatering. In the present system the tails are filtered to remove liquid. Since the tailing's composition is essentially the same then as now, it is assumed the low leaching potential was equivalent and therefore constituents of the tailings pile did not leach with the percolating water.

5.9.5 Evidence of Releases and Potential Environmental Impacts

Dark stained soils north, south, east, and west of this SWMU suggests wind-blown dispersion has occurred. The dark stained soils are apparent for several hundreds of feet north, south, and west of the tailings pile and appear to extend a short distance to the east of the KMCC/Timet property line. Airborne tailing material was observed during an August 19, 1991 SR.

Kleinfelder did not find documentation reflecting groundwater impacts which could be attributed to disposal or leaching of the manganese tailings materials either from the present process or from the previous slurry operation.

5.9.6 Analysis of Release Prevention or Mitigation Measures

Prior to February 1975, the manganese tailings were slurried to leach beds and the water either evaporated or percolated into the soil (Reference K056). The conversion to a dewatered tailings material in February 1975 represents a mitigative measure that would reduce the potential for impacts to groundwater.

Airborne dispersion of particulate matter is somewhat reduced by placing and grading the tailings while moisture content is sufficiently high to reduce dust. Dispersion by surface water run-off is controlled by diversion ditches on the north, east, and west sides of the tailings area. Drainage in this area of the facility is directed away from the tailings area to reduce surface water run-on and divert this around the tailings area. Surface water that exits this SWMU via these diversion ditches would discharge through an NPDES monitoring point just northwest of the tailings area (Reference K158A; SR, August 19, 1991).

A site specific groundwater monitoring system is not in place for the manganese tailings area. Monitoring wells present north and downgradient of this area are used to monitor surface impoundment C-1. The current groundwater monitoring program for SI C-1 and other portions of this facility does not include analyses of heavy metals and other parameters which could be used to evaluate this SWMU.

5.10 Old P-2 Surface Impoundment

5.10.1 Unit/Area Design and Operational History

This pond (SWMU KMCC-010) was a lined process surface impoundment (SI) located approximately 300 feet southwest of the steam plant and within the fenced and guarded KMCC facility (Reference Map 10). This pond had a 12,000 square foot surface area and a 350,000 gallon capacity (Reference K031, UE024). The old P-2 SI was originally constructed in the fall of 1972 with a single layer of polyvinyl chloride (PVC) on the bottom joined to chlorinated polyethylene (CPE) on the side walls (Reference K003, K220, UE024, UE030). Prior to June 1980, the PVC/CPE liner was replaced because these materials were apparently incompatible when in contact with each other and leaks had developed along the seams (Reference UE024). The PVC/CPE single liner was replaced with a nylon reinforced butyl rubber single liner (Reference UE024).

The old P-2 SI was again relined sometime between June 1982 and August 1984 utilizing a double liner system with a surface area of 13,000 square feet and a capacity of 675,000 gallons (Reference K031, K064, K117, K158A, K223, UE024). The bottom was lined with a 30 mil. unreinforced PVC membrane, the side underliner was a polypropylene geotextile with a weight of 400 gm/m², and the upper liner was a 36 mil. Polyester reinforced Hypalon membrane (Reference K117, K158A, K167, K223). A second top liner consisting of 60 mil. high density polyethylene (HDPE) was installed between August 1984 and July 1985 because part of the former double liner system had failed (Reference K117, K158A, K167, K223). The old P-2 SI continued to operate until April 1990 when decommissioning was initiated (Reference K220).

The old P-2 SI received sodium chlorate solution from process washdown, excess solution above the handling capacity of the process vessels, storm water from within the process area, caustic scrubber solution from the ammonium perchlorate plant, and solution from cooling tower leaks (Reference K031, K158A, K167, UE024). These solutions were concentrated in the SI through evaporation and then returned to the process where residual sodium chlorate was recovered (Reference K220, UE024).

The old P-2 SI is in the process of clean closure per 40 CFR Part 265, Subpart K. The liner, the solid contents, and adjacent and underlying soil were removed and disposed off-site at the U.S. Ecology, Inc., Beatty, Nevada facility during late June and early July 1990 (Reference K220, K354).

During an August 20, 1991 SR, the former location of the old P-2 SI was observed. The liner system had been removed and the area surrounding the former SI location consisted of exposed soil. Dark colored soil was noted in the western wall of the old P-2 excavation and exhibited stratification indicating the likely presence of manganese tailings from past area use activities (for a discussion of these manganese tailings area, please see Section 5.22). The soil around the SI exhibited a white crusty discoloration. Light colored soils were also observed as patches in the bottom of the excavation at approximately four to five feet below grade.

The amount of surface water run-on that may flow into the excavation is limited because there is a run-on control ditch approximately 15 feet south of and parallel to the southern edge of the SI excavation. This ditch is directly north of the diesel storage frontage road which also parallels the southern portion of this SWMU. There is a drainage ditch to the east of New P-2 access road east of this SWMU which receives or diverts most of the surface water run-off from the surrounding areas.

5.10.2 Unit/Area Waste Characteristics

The former old P-2 SI received chlorate process liquids which contained hexavalent chromium, sodium chloride, sodium chlorate, and sodium perchlorate (Reference K031, K037, K039, CA017, UE024). The latter compound was from the caustic scrubber solution generated at the ammonium perchlorate plant (Reference K031). The soils adjacent to and underlying the former old P-2 SI are potentially contaminated with hexavalent chromium as a result of historic liner leaks (Reference K223, UE024).

5.10.3 Regulatory Status of Unit

Old P-2 SI was one of several process ponds regulated by the NDEP in conjunction with KMCC's NPDES Permit (NV0000078) (Reference K158A). Old Pond P-2 did not receive hazardous waste as classified by RCRA, therefore the SI was not a RCRA

regulated storage facility. This SI is currently undergoing closure in accordance with applicable solid waste rules. The liner and adjacent/underlying soils have been removed and disposed off-site at U.S. Ecology, Inc.'s, Beatty, Nevada facility (Reference K354).

5.10.4 Waste Constituent Migration Pathways

The migration pathways include historic releases of hexavalent chromium bearing liquids to soil and percolation through the soil to potentially impact the shallow groundwater.

5.10.5 Evidence of Releases and Potential Environmental Impacts

A review of documents revealed that the old P-2 SI leaked an unknown quantity of solution on more than one occasion. The original single liner was replaced with a different single liner prior to June 1980 because leaks had developed (Reference UE024). In June 1982, this second single liner failed and approximately 50,000 gallons of solution leaked (Reference K064). This single liner was subsequently replaced with a double liner system sometime between June 1982 and August 1984 (Reference K031, K064, K158A, K223, UE024). A second upper liner was added sometime between August 1984 and July 1985 because part of the original double liner system failed (Reference K117, K158A, K223).

A review of the 1985 Hydrogeological Investigation report prepared by KMCC reveals shallow groundwater north (downgradient) of the old P-2 area (which also included other SIs) exhibited elevated chromium and conductivity values (Reference K167). The 1985 report indicated that the observed impacts in the area were from a major plume that extended north from Units 4 and 5 (Reference K167). The observed groundwater impacts may also be partially related to historic leaks from this SI.

The surficial soils in the vicinity of the old P-2 SI, on the floor of the former SI and around the base of a nearby P-2 pump station exhibited white crystalline discoloration during an August 20, 1991 SR. The chemical constituents comprising this discoloration were not evaluated. Sampling and analyses will be conducted during closure activities to evaluate potential environmental impacts.

5.10.6 Analysis of Release Prevention or Mitigation Measures

The release prevention methods employed at this SWMU included the use of single followed by double liner systems, control of discharge to the SI to avoid overtopping, and periodic pond solution level monitoring to assess potential leaks (Reference K031, K158A, UE024, UE030). Once leaks were indicated through the pond monitoring program or when observation showed the liner was unserviceable, repairs were made or the liner was replaced (Reference K220, K223, UE024).

Removal of the liner and soil from the sides and from beneath the former old P-2 SI are the mitigative measures employed to date for the historic releases. Sampling and analyses during closure will provide additional information which can be used to evaluate the existence and extent of potential impacts created by historic releases.

5.11 C-1 Surface Impoundment

5.11.1 Unit/Area Design and Operational History

This single-lined process wastewater surface impoundment (SWMU KMCC-011) is located near the eastern property boundary, approximately 400 feet north of the manganese tailings pile area, and within the fenced and guarded KMCC facility (Reference Map 11). This SI was constructed in October 1974 using a single layer of PVC on the bottom and reinforced butyl rubber sides (Reference K003, K013, K031, UE024, UE030). The liner fabric is reported to be 60 mil. thick. The C-1 SI has a surface area of 69,000 square feet and an approximate capacity of 3,125,000 gallons (Reference K031, K158A). This SI is used to hold nonhazardous industrial liquid waste for evaporation and is not equipped to recycle the liquids back to the processes (Reference K031, K147, UE024, UE030). Four groundwater monitoring wells monitor the C-1 SI area per an NDEP approved leak detection program (Reference UE057).

The operating practices at this SI consist of receipt of wastewaters from the following activities (Reference K031, K117, K158A, K305):

- o boiler plant blowdown - 2.8 to 8.9 gallons per minute (gpm);
- o boiler plant washdown - episodic;

- o manganese dioxide cathode wash solution - 1.2 to 8.1 gpm;
- o boron neutralization solutions - 0.9 to 1.9 gallons per minute; and
- o hot process water softener solutions - 2.0 gallons per minute.

Historically, the C-1 SI also received approximately 15,000 gallons per day of main cooling tower blow down and filter wash (Reference K031).

The waste stream amount to the C-1 SI has been reduced considerably by the installation of vapor recompression units as part of steam plant modifications in 1989 (Reference K331, K334, K338). Consequently, the water level in the SI has been reduced and there is approximately an additional four feet of freeboard available (Reference K334).

The C-1 SI was observed during an August 20, 1991 SR. The C-1 SI contained a float and sprinkler system used for increasing the evaporation rate. On the day of the SR (August 20, 1991) the sprinkler was not operating because the water level in the SI was so low the intake pumps would take in sludge from the bottom of the SI and plug the system. The C-1 SI was receiving wastewater from the boiler/steam plant blowdown line and the boron neutralization line.

The SI freeboard appeared adequate for the present waste stream inflow and the area was well maintained. The SI side berm tops were flat, approximately 30 feet wide, and well graded allowing access on all sides of the SI.

The four area monitoring wells were observed on August 20, 1991: one is located to the south-southwest (upgradient); one is located directly east (which is lateral-gradient and also used for monitoring the quality of groundwater at the KMCC/Timet property line); and two are located downgradient of the C-1 SI, one directly north of the north side of the SI and one further west.

Surface water run-on may flow into the SI from the surrounding bermed area because the berm grades slightly towards the SI. Because the top of the berm is elevated above the surrounding area on the east, north, and west sides, surface water flowing toward the SI would be diverted around the bermed area to the east and west and into channels that are tributary to the Beta Ditch.

5.11.2 Unit/Area Waste Characteristics

The C-1 SI receives nonhazardous liquid wastes from the activities listed in Section 5.11.1 (Reference K147, K158A). Sampling and analysis of the facilities waste streams are reported to the NDEP annually per the KMCC NPDES permit (Reference K158A). A typical chemical composition for each of the waste streams is listed below in Table 5.11.1.

TABLE 5.11.1
1989 ANNUAL WASTE STREAM ANALYSIS

	Pond C-1						
	<u>pH</u>	<u>Na</u>	<u>TDS</u>	<u>Ca</u>	<u>Mg</u>	<u>Mn</u>	<u>K</u>
Cathode Wash	5.9	na	14.4	2.2	.368	.00014	na
Neutral Boron	7.8	19.2	179.0	.047	20	na	na
Steam Plant Blowdown	10.2	.195	4.1	.0028	.0010	na	.0051

Units = pH in S.U.; All other units in g/l; "na" indicates no analysis. (Reference K158A)

Constituents in the various waste streams discharged to the C-1 SI are sodium hexametaphosphate, neutralized sulfuric acid, calcium and magnesium hydroxide, and boron neutralization wastewater (Reference K170, K179, UE024). The sodium hexametaphosphate contained in this wastewater is a dispersant and wetting agent. Documentation was not found regarding testing of pond solids by TCLP or EP TOX methods.

5.11.3 Regulatory Status of Unit

This SI is a nonhazardous wastewater holding/evaporation pond which is regulated by the NDEP in conjunction with KMCC's NPDES Discharge Permit (NV0000078) (Reference K020, K158A). KMCC has been monitoring their ponds since the summer

of 1974 (Reference K020) and has monitored the C-1 SI since it was placed in service in late 1974 or 1975 (Reference K158A, UE024, UE030). The NDEP anticipated this SI would be removed from service in 1991 (Reference K158A). KMCC has informed the NDEP that closure of this SI is now planned for 1993 (Reference UE057).

The pond leakage monitoring plan (Reference K060) was approved by the U.S. EPA and became effective August 30, 1975 (Reference K020). Groundwater monitoring is conducted monthly to assess the integrity (check whether the SI has leaked or not) of single-lined SIs. KMCC monitors groundwater in selected groundwater monitoring wells for discrete parameters and constituents. Groundwater analytical results, and a chemical makeup of the process streams and waste streams received by each SI, are reported in monitoring reports submitted to the NDEP (Reference K017, K054, K057, K064, K069, K158A, K305, K320, UE032 through UE057). The results of liquid levels and visual observations are routinely recorded and maintained at KMCC for NDEP review (K357).

The groundwater monitoring program for the C-1 SI includes measurement of pH, conductivity, and sodium chloride (Reference UE057). The current monitoring network consists of monitoring wells M-19, M-22, M-35, M-39 (Reference UE057). Prior to January 1990, the monitoring network consisted of monitoring wells M-18, M-19, and M-22 (Reference UE032 through UE037).

5.11.4 Waste Constituent Migration Pathways

The migration pathways are to immediately surrounding surface soils from surface spills, subsurface soils from a leak in the SI liner, and potentially to shallow groundwater.

5.11.5 Evidence of Releases and Potential Environmental Impacts

Indications of a release from the SI were not observed on the day of the SR. However, the liner exhibited some signs of deterioration. Evidence of a release to the SI was observed during the SR from a pressure relief hole in the steam plant blowdown line.

A small erosion channel had formed and extended from the pressure relief hole to the SI. The point of discharge from the pressure relief hole may be outside of the margin of the C-1 SI liner.

The graphical presentations of groundwater monitoring results for sodium chloride and conductivity in the C-1 monitoring well network were reviewed for the period of August 1985 through December 1989 and July 1990 through November 1991. The sodium chloride and particularly the conductivity graphs showed a trend for the data obtained from MW-22, a monitoring well positioned downgradient and northwest of the C-1 SI. Review of the conductivity values revealed a generalized conductivity trend from approximately 6,000 umhos/cm in 1985 and 1986; through approximately 1,000 umhos/cm in December 1987; to approximately 12,000 to 14,000 umhos/cm in 1990 and 1991. This data indicates a possible source of groundwater impact upgradient of MW-22. However, the source location is difficult to evaluate based on this spatially limited data and the existence of several possible sources/upgradient of this monitoring well at locations on both KMCC and Timet property (Reference K167, K305, UE057).

Between February 23, 1979 and March 5, 1979, approximately 840,000 gallons of wastewater were discharged from the C-1 SI to the Beta Ditch and on to the BMI ponds. This action was conducted to prevent damage to the C-1 SI and was reported to the NDEP (Reference K032).

5.11.6 Analysis of Release Prevention or Mitigation Measures

Release prevention relies on the integrity of the liner and control of discharge to the SI. Groundwater monitoring using the monitoring well network in the vicinity of this SI serves to assess liner integrity. The revised monitoring network approved by the NDEP in July 1990 appears to be improved compared to the former monitoring well network (Reference K158A).

5.12 Mn-1 Surface Impoundment

5.12.1 Unit/Area Design and Operational History

This double-lined wastewater surface impoundment (SWMU KMCC-012) is located near the eastern property boundary, approximately 200 feet north of the manganese

tailings pile area, and within the fenced and guarded KMCC facility (Reference Map 12). The Mn-1 SI was placed into operation in May 1983 (Reference K357). The double liner system is comprised of a bottom liner constructed of four to six inches of compacted bentonite clay with a permeability of 10^{-8} centimeters per second; a side underliner of polypropylene geotextile with a weight of 400 gm/m^2 ; and a top liner of 60 mil. HDPE (Reference K117, K147, K158A). A leak detection piping system is in place between the two liners. The Mn-1 SI has a surface area of 53,000 square feet and a capacity of 3,500,000 gallons (Reference K117, K147, K158A). This SI is used to hold nonhazardous liquid waste for evaporation and is not equipped to recycle the liquids back to the process (Reference K117, K147, K158A).

The present operating practices consist of receipt of nonhazardous wastewater piped from the manganese dioxide process area in Unit 6 (Reference K147). The wastewater is comprised of manganese dioxide cell feed filter waste and potassium phosphate cathode wash solution (Reference K117, K147, K158A).

Historically, this SI also received calcine belt filter washwater from the manganese dioxide leach plant where KMCC used to rinse and leach manganese ore to remove soluble potassium. That process was discontinued in September 1989 (Reference K334).

During an August 20, 1991 SR, the Mn-1 SI was receiving water from the cathode wash process line. The SI appeared adequate for the waste stream flow and the area was well maintained. The exposed portion of the liner did not appear to have tears, or other obvious indications of compromise of integrity. Evidence of liquid discharge from the SI was not observed.

The SI side berms were flat, approximately 30 feet wide, graded level, and the tops were approximately six feet above grade. These berms were well graded, provide access to all four sides of the SI, and provided effective surface water run-on control. Surface water run-on toward the SI would be diverted around the bermed area to the east and west and into channels that are tributary to the Beta Ditch.

5.12.2 Unit/Area Waste Characteristics

The nonhazardous liquid wastes received by the Mn-1 SI include manganese dioxide cell feed filter waste and potassium phosphate cathode washwater. This cathode wash waste stream contains calcium, magnesium, manganese from cathode scale, tank mud, cell sludge, sodium hexametaphosphate (a dispersant and wetting agent), and other naturally occurring constituents as described in Section 4.8 (Reference K117, K158A, K269). The wastewater held in this SI contains high TDS resulting in deposition of solids in the SI bottom as solutions evaporate (Reference K146A). Documentation was not found regarding testing of these solids by TCLP or EP TOX methods.

5.12.3 Regulatory Status Unit

This SI is a nonhazardous wastewater holding/evaporation pond regulated in conjunction with KMCC's NPDES Discharge Permit (NV0000078) (Reference K020, K158A). The pond leakage monitoring plan (Reference K060) was approved by the U.S. EPA and became effective August 30, 1975 (Reference K020).

In accordance with the requirements of the permit, KMCC conducts routine visual inspections to assess the status of double-lined SIs. The general chemical analysis of waste streams received by each SI are reported in annual monitoring reports submitted to the NDEP (Reference K158A, K305, K320). Records of routine liquid level checks, leak detection system checks, and visual observations are maintained at KMCC for review by NDEP (K357).

5.12.4 Waste Constituent Migration Pathways

The potential migration pathways are to immediately surrounding surface soils from surface spills, and to subsurface soils from leaks through the secondary liner.

5.12.5 Evidence of Releases and Potential Environmental Impacts

Indications of releases of Mn-1 SI liquids were not observed on the date of the SR. Granules of white crystalline material (possibly salts) were observed scattered on the northern SI berm.

The discharge monitoring reports (DMRs) reviewed by Kleinfelder included monthly DMRs from June 1990 through November 1991. These DMRs indicated no fluid was detected between the Mn-1 SI liners (Reference UE041 through UE057). Other documentation of historic releases from this SWMU was not found during this study.

5.12.6 Analysis of Release Prevention or Mitigation Measures

The release prevention methods include a double-liner system and control of discharge to the Mn-1 SI to avoid subsurface releases and overflowing of the SI, respectively. The leak detection monitoring system, positioned between the two liners, serves as early warning of a release through the primary (top) liner.

5.13 Hazardous Waste Landfill (Closed)

5.13.1 Unit/Area Design and Operational History

The KMCC hazardous waste landfill (SWMU KMCC-013) consists of one unlined subsurface cell with a maximum capacity of approximately 332,000 cubic feet. The hazardous waste landfill is located within the fenced and guarded KMCC facility near the west central portion of the KMCC property (Reference Map 13). The landfill cell measures approximately 410 feet long by 45 feet wide by 20 feet deep (Reference K108, K147, UE108).

The hazardous waste landfill was constructed in a portion of the area formerly used by the U. S. Government between 1941/1942 and 1944/1945 as one of four "Trade Effluent" settling ponds (Reference Section 5.14 of this report). A review of aerial photography also revealed that this area received material of unknown origin from prior to November 1960 to at least August 1979 (Reference K164).

The hazardous waste landfill operated between February 1980 and January 23, 1983 (Reference K056, K095, K108, K128, K130, K147). This landfill was subsequently closed and capped and is currently under post-closure care as required by a closure/post-closure plan approved by the NDEP on April 16, 1985 (Reference K108, K112, K128, K138, K147).

During operation, wastes were placed in this landfill in truckload size increments (approximately 20 cubic yards) and mixed with equal volumes of soil to solidify. Each lift was compacted to minimize later subsidence. The upper fill was comprised of soil originating from the closure of SI S-1 (Reference K071, K108, K147).

Capping of the hazardous waste landfill occurred between September 6, 1985 and October 17, 1985. A multi-layered cover system was installed by Espy Brothers and Serrot Corporation. The cover extends approximately five feet laterally beyond the boundary of waste placement and was comprised of: (1) A 1-1/2 to 4 foot thick compacted clay layer (with less than 10^{-7} centimeters/second permeability), (2) a 40-mil. HDPE membrane, (3) a six-inch thick clay layer, and (4) a one-foot thick drainage layer of compacted granular soil. Three settlement monuments were set in the cover and their locations and elevations recorded on October 17, 1985. Observations and field testing were provided by J. H. Kleinfelder and Associates (Reference K128).

This hazardous waste landfill was observed during an August 20, 1991 SR. On that day, the landfill cap was free of obstructions, vehicles, or other objects. The eastern side of the landfill was protected from drive-on traffic by a low berm that extended the length of the landfill. The western side of the landfill was bordered by an access road which paralleled the western property boundary. The area appeared to have been recently graded and was well maintained. Survey monuments for measurement of settlement were in place. Three caution signs were observed at both the north and the south ends of the landfill. The signs displayed: "Authorized Personnel Only", "Hazardous Waste Landfill", and "Do Not Drive on or Disturb Cap".

The surface is graded with a slope towards the east to facilitate drainage and direct surface water run-off away from the landfill area.

5.13.2 Unit/Area Waste Characteristics

The wastes disposed of in the hazardous waste landfill contained chromium in the sodium chlorate and potassium perchlorate process solids (Reference K108). These wastes were placed in the hazardous waste landfill between February 1980 and January 23, 1983 (Reference K056, K095, K108, K130). Waste disposed of in the hazardous waste landfill included the following (Reference K108, K147):

- o approximately 3,000 cubic yards of sodium chlorate filter cakes originating from the sodium chlorate process; and
- o materials from the closure of SI S-1 which included the liners, an unknown quantity of solids (the solid contents of the SI), and approximately 2,900 cubic yards of chromium contaminated soil.

The sodium chlorate filter cakes consisted chiefly of diatomaceous earth with carbon; calcium sulfate; sodium carbonate; calcium carbonate; soluble salts including NaCl and NaClO₃; and 0.05 to 1 percent hexavalent chromium. Materials containing hexavalent chromium were managed as hazardous waste (Reference K037, K056, K219, K278, CA017) (Reference K147)

5.13.3 Regulatory Status of Unit

KMCC submitted a closure plan for the hazardous waste landfill to the NDEP on January 21, 1983 (Reference K071). Following incorporation of comments at the request of the NDEP, a revised closure plan was submitted on October 26, 1984 (Reference K108, K130). The revised closure plan was approved by the NDEP in a letter dated April 16, 1985 following the public comment period (Reference K112).

Closure of the hazardous waste landfill was conducted under 40 CFR Part 265 interim status standards and the approval of the NDEP (Reference UE131). Closure included installation of a multi-layered cover system comprised of low permeability compacted clay, a synthetic membrane, and compacted granular soil (Reference Section 5.13.1 of this report). J. H. Kleinfelder and Associates provided observation and field testing services during cover construction. Closure groundwater monitoring requirements included monthly recording of groundwater levels and analysis for chromium, as well as semi-annual analysis for pH, EC, TOC, TOH, chromium, chloride, sodium, sulfate, iron, manganese, and phenols. Based on the information provided by KMCC, field observations, and field testing, a professional opinion was rendered that the hazardous waste landfill was closed in conformance with the intent of the approved closure/post closure plan (Reference K128). The NDEP subsequently acknowledged closure of the hazardous waste landfill in a letter dated January 17, 1986 (Reference K138).

Because closure entailed in-place capping of hazardous wastes, this landfill remains under the interim status standards of 40 CFR Part 265 (Reference UE131). As such,

the NDEP requested KMCC initiate and continue post-closure activities in accordance with the approved closure/post-closure plan (Reference K138). The required post-closure activities include periodic inspection and maintenance of the cap, annual elevation check of the settlement benchmarks, and periodic groundwater monitoring (Reference K108, K128, K147). The groundwater monitoring parameters required for the post closure period were reduced to: pH, EC, TOC, TOH, and Cr and groundwater level (Reference Doc. # K108).

Quarterly groundwater monitoring of the shallow groundwater was initiated in October, 1982 using the four monitoring wells surrounding the hazardous waste landfill (i.e. M-5, M-6, M-7, and H-28). In December 1988, the NDEP approved reduction in sampling frequency to an annual basis because chromium, the constituent of concern, had not been detected (Reference K179).

5.13.4 Waste Constituent Migration Pathways

During the operational life of this landfill the waste migration pathways would have included the air, soil, surface water, and groundwater. Dry soil and/or solids could have become airborne during mixing and landfilling operations. Additionally, wastes could have migrated into the underlying and adjacent soil as a result of infiltration from precipitation events.

The migration pathways have been reduced significantly through installation of the multi-layered cover in September and October 1985. The cover limits migration of waste to the air and surface water and also serves as a barrier to infiltration of precipitation.

5.13.5 Evidence of Releases and Potential Environmental Impacts

Kleinfelder did not find documentation of releases occurring during the operational life of the hazardous waste landfill (February 1980 through January 23, 1983) or during the closure/post-closure period. Evidence of releases from this landfill were not observed during the August 20, 1991 SR.

Groundwater monitoring of four monitoring wells in the vicinity of the hazardous waste landfill has been conducted since October 1982. The results of this monitoring has not

detected the presence of chromium in shallow groundwater at concentrations greater than the detection limits (Reference K058, K066, K068, K077, K092, K106, K126, K146B, K153, K155, K158, K169, K179).

5.13.6 Analysis of Release Prevention or Mitigation Measures

Methods of release prevention employed during the operational life of the hazardous waste landfill included (Reference K108):

- o mixing of wastes (which were routinely in the form of a damp filter cake) with equal volumes of soil to solidify; and
- o compacting the stabilized material in lifts.

After waste placement ceased (prior to January 23, 1983) and the closure plan was approved, an engineered cover system was installed in September and October 1985 (Reference K128). This multi-layered cover was designed to serve as the primary method of release prevention and prevent storm water infiltration. The cover appears to function adequately for directing water from the area thus reducing surface water infiltration, and significantly reducing the potential for releases. Groundwater monitoring conducted in the vicinity of the hazardous waste landfill has not detected chromium in shallow groundwater downgradient of this SWMU (Reference K058, K066, K068, K077, K092, K106, K126, K146B, K153, K155, K158, K169, K179).

5.14 Trade Effluent Settling Ponds (U.S. Government Operations)

5.14.1 Unit/Area Design and Operational History

The following paragraphs present information related to U.S. Government operation of four "Trade Effluent" settling ponds. These ponds extend onto both the BMI common areas and KMCC property. Information presented here regards use of the portions of this area which occur on KMCC property and are designated as SWMU KMCC-014.

The historic "Trade Effluent" settling ponds are located near the north central portion of the BMI complex. The original system was termed "Trade Effluent" disposal system and was comprised of four surface impoundments and a distribution pipeline. Each settling pond had an area of approximately 20 acres and an average liquid level depth of 7-1/2 feet (Reference UL020).

The settling ponds were formed by construction of earthen dikes around the northern, eastern, and western sides. A dike was not necessary along the southern side because the impoundments were constructed on an alluvial fan which slopes to the north. A french drain system was also incorporated into the design (Reference K161, GM001, GM002).

Wastes were conveyed by the acid drain system and absorber drain system to an acid neutralization plant (Reference K163, K164, UL020, N009). The distribution pipeline then conveyed these wastes from the acid effluent neutralization plant to the settling ponds (Reference K163, GM001). Initially, the acid waste was neutralized with waste caustic liquor prior to discharge to the settling ponds (Reference UL020). This neutralization practice was abandoned when the caustic line disintegrated (Reference UL020).

The actual dates of Trade Effluent settling pond operations are not known. Based on the reviewed literature, these ponds probably began receiving wastes when operations started in the fall of 1942 and may have been used until the magnesium plant was closed on November 15, 1944 (Reference UL001). Use of these ponds for management of liquid waste after November 15, 1944 is not known.

SWMU KMCC-014 is defined as the portion of the Trade Effluent settling ponds which occur on KMCC property (Reference Map 14). This SWMU extends from the northern limits of the french drain system located north of the northern settling pond containment dike/berm to the limit of waste placement along the south side; and from the western KMCC property boundary to the easternmost containment dike/berm (Reference K056, K161, K164). Therefore, approximately two and one fifth of the original four settling ponds are located within the fenced and guarded KMCC property.

After use of these settling ponds by the U.S. Government operations ceased, SWMU-014 also received facility solid materials/wastes at various times between 1945 and 1979. A review of 1950, 1960, 1969, and 1979 aerial photography confirmed that portions of this area received solid materials/wastes (Reference K164). Portions of the southern extent of the former settling ponds were converted to AP storage areas by approximately 1953 (Reference aerial photograph at the BMI office). It is possible that the solid materials/wastes observed in the 1960 photography were either fill, or excavated wastes or soils which were relocated during construction of the AP storage areas.

The majority of this SWMU apparently remained relatively inactive until the 1980s. Between February 1980 and January 1983, the KMCC hazardous waste landfill was constructed and operated in the western portion of this area (Reference K056, K108, K147, K164; SWMU KMCC-013). This landfill was closed and a multi-layered cover system was subsequently constructed over this landfill in September and October 1985 (Reference K128). In approximately October 1988, surface impoundments WC-1 and WC-2 were constructed in the northeastern portion of this area (Reference K342; SWMU KMCC-015 and -016). Additionally, material was borrowed from portions of this SWMU area between August 1979 and July 1987 (Reference K161, K164).

Descriptions of SWMU KMCC -013, -015, and -016 are provided in Sections 5.13, 5.15, and 5.16 of this report.

Portions of SWMU (KMCC-014) were observed during an August 20, 1991 SR. During the SR, activity was not observed in the unoccupied portions of this SWMU. The area was clear of litter, equipment, and other materials indicative of present or recent use for storage. Portions of the historic dikes were present and appeared to help

restrict access to this SWMU. The soil appeared to have been graded or excavated at some areas within this SWMU. At these locations, gray colored soil or waste was exposed. This material appeared to be an indicator of the historic waste disposal operations (Reference K164).

Surface water run-on would flow into this SWMU from the east, south and west. This area would act as a retention basin. Due to the presence of berms on the north and east, run-off from this SWMU would not occur.

5.14.2 Unit/Area Waste Characteristics

The chemical composition of the liquid waste discharged to the Trade Effluent settling ponds during U.S. Government operations is unknown. This waste included both acid and caustic process liquors (Reference UL020). The acid liquor was comprised of hydrochloric acid generated from primary and secondary scrubbing towers which washed chlorinator exhaust gases in the chlorination portion of the "metal units" (Reference UL020). The caustic waste was generated from absorber towers installed to remove the last traces of chlorine and hydrochloric acid passing the primary and secondary scrubbing towers. The absorber towers used waste caustic liquor from the chlorine plant for this purpose (Reference UL020). The waste caustic solution is presumed to be sodium hydroxide (Reference K037).

The nature of solid materials/wastes placed within this area at various times between 1945 and 1979 is unknown. This material may have been solids generated during neutralization of wastes discharged to these ponds or fill added to adjust the grade of the area.

Portions of exposed parts of the former settling ponds exhibited a light colored surface in the 1960, 1969, and 1979 aerial photography (Reference K164). Additionally, darker gray colored material was observed during the SR in a shallow excavation on the western portion of this SWMU. Kleinfelder did not find documentation regarding the chemical characteristics of this material.

Prior to construction of WC-1 and WC-2 within the former Trade Effluent settling pond area, soil samples were collected from two areas and analyzed by EP Toxicity procedures. Two near surface soil samples were analyzed for the presence of six

organic compounds. Nine soil samples, collected between one and sixteen feet below grade, were analyzed for the presence of eight RCRA metals. Each analyte (except barium) was reported at non-detectable concentrations in each sample. Barium was reported at concentrations ranging between 0.1 and 1.0 mg/L. The soil pH was reported to range between 6.5 and 8.4 units (Reference K 353).

5.14.3 Regulatory Status of Unit

Kleinfelder did not find documentation regarding any special regulatory status for this area. The liquid effluent discharges to this area during U.S. Government operations were probably not specifically regulated.

The regulatory status of other SWMUs located in this area (SWMU KMCC -013, -015, and -016) are presented in applicable sections of this report.

5.14.4 Waste Constituent Migration Pathways

During the operational life of these settling ponds, the migration pathways would have included air, soil, and groundwater. These pathways could have been involved with waste migration after 1945 especially when the surficial material was disturbed or a significant precipitation event occurred.

Air releases could have occurred if contaminated particles became airborne. Airborne releases most likely occurred when heavy equipment operated in this area for:

- o the construction of the AP storage area in the early 1950s;
- o the construction, use and closure of the hazardous waste landfill between February 1980 and late 1985; and
- o the construction of WC-1 and WC-2 in late 1988.

Air releases can continue to occur in areas where the waste is exposed at the surface.

Releases to the soil occurred historically because the settling ponds were not lined. Liquid wastes discharged to these ponds percolated into the underlying soil and groundwater.

5.14.5 Evidence of Releases and Potential Environmental Impacts

Kleinfelder did not find documentation that releases to the air occurred during the operational life of these settling ponds or since their use was terminated.

Historic releases to the soil occurred based on the fact that the settling ponds were not lined. Additionally, review of the April 18, 1943 aerial photography revealed that seepage had occurred along the base of the northern containment dike (Reference K164).

Historic releases to the groundwater occurred because these settling ponds were not lined and wastewater seeped into the near surface coarse alluvium. Residents of Pittman were confronted with rising groundwater conditions which caused flooding of basements and cesspools in 1943 and 1944. The shallow groundwater table near the center of Pittman dropped approximately 11 feet within 2 years after two of these settling ponds were abandoned (Reference UB003).

5.14.6 Analysis of Release Prevention or Mitigation Measures

Historic surface release prevention measures associated with the Trade Effluent settling ponds appear to be limited to the construction of containment dikes to confine disposal to a defined area. Because the settling ponds were constructed without liners, liquid wastes discharged to these ponds percolated into the underlying soil and probably into groundwater. Additionally, air releases could have occurred after use of the settling ponds was terminated and the residual wastes dried.

Construction of the AP storage area over a portion of the southern part of this SWMU, the hazardous waste landfill along the western portion of this area, and WC-1 and WC-2 SIs near the eastern portion of this area have altered the site layout. Due to the presence of these features, potential releases of former settling pond wastes to the air, soil and groundwater are somewhat reduced.

5.15 WC-1 (WC-West) Surface Impoundment

5.15.1 Unit/Area Design and Operational History

This double-lined wastewater surface impoundment (SWMU KMCC-015) was constructed within the former Trade Effluent settling pond area and is located near the central portion of the fenced and guarded KMCC facility (Reference Map 15). The

double liner system is comprised of a bottom liner constructed of a 40 mil. HDPE membrane; a side liner constructed of a 105 mil. polypropylene geotextile, HDPE drainage netting, and a 40 mil. HDPE membrane; and an upper liner consisting of a 60 mil. HDPE membrane. The SI has a leak detection system between the top and bottom liners. The WC-1 SI has a surface area of 67,600 square feet and a capacity of 12,515,200 gallons. This SI was constructed with soil berms which stand approximately 10 to 12 feet above the surrounding area. The berm area around the SI is approximately 25 feet wide, flat, and relatively level (Reference K158A, K320; SR, August 20, 1991).

The leak detection system is comprised of monitoring pipes and conductivity detectors. Two, four-inch diameter PVC monitoring pipes allow access to the low point of the secondary containment liner. These pipes are equipped with detectors to monitor for leaks through the top liner (Reference K357).

The WC-1 SI was constructed in late 1988, placed into operation in March 1989, and presently is in use (Reference K342; SR, August 20, 1991). This SI receives a composite liquid waste stream from Units 3, 5, and 6 and the steam plant (Reference K158A). The solutions flowing to this SI are from the following sources (Reference K158A):

- o process water softeners;
- o steam generation blowdown;
- o cooling tower blowdown from Units 3 and 5;
- o manganese dioxide product wash solution from Unit 6;
- o manganese dioxide cathode wash solution;
- o process seal water/filter flush; and
- o concentrated brine from the vapor recompression units.

Solution from this SI is then processed through vapor recompression units to reclaim water for cooling and process use (Reference K158A). The concentrated brine effluent from the vapor recompression unit is discharged to either the WC-1 or WC-2 SI.

This SI was observed during an August 20, 1991 SR. On that date, the WC-1 SI had approximately five feet of freeboard. The SI was surrounded by a flat and relatively level berm approximately 25 feet wide and 10 to 12 feet higher than the surrounding

area. The rolled edge of the liner appeared to act as a small berm to reduce run-on into the SI. Precipitation may cause minimal inflow from the top of the berms or the liner surface. Surface water run-on from the south would be diverted around the SI by the berms. Surface water run-off should be minimal from the top of the berms.

5.15.2 Unit/Area Waste Characteristics

This SWMU receives wastewater from Units 3, 5, and 6 and the steam plant (Reference K158A). This wastewater originates from the following sources: process water softeners; steam generation blowdown; cooling tower blowdown from Units 3 and 5; manganese dioxide product wash solution from the clarifier in Unit 6; process seal water/filter flush; and concentrated brine from the vapor recompression units (Reference K158A).

Sampling and analysis of the facilities waste streams are reported to the NDEP annually per the KMCC NPDES permit (Reference K158A). The chemical composition and average flow rate for waste streams directed to the WC-1 SI for 1990 are listed below in Table 5.15.1.

Table 5.15.1

1990 Annual Waste Stream Analysis

	<u>pH</u>	<u>Na</u>	<u>TDS</u>	<u>Ca</u>	<u>Mg</u>	<u>Mn</u>	<u>K</u>	<u>Average Flow</u>
Steam Plant Blowdown	9.9	0.36	1.24	0.030	0.018	n/a	0.011	8.9
RCC Composite	7.1	44	134.6	1.0	1.92	0.61	3.46	1.8

Units = pH in S.U., Average Flow in gpm, All other units in g/l, "n/a" indicates no analysis (Reference K305).

This composite waste stream exhibits a pH of approximately 7.1 to 10.2 (Reference K158A, K305, K320).

Prior to construction of WC-1 and WC-2 within the former Trade Effluent settling pond area, soil samples were collected from two areas and analyzed by EP Toxicity procedures. Two near surface soil samples were analyzed for the presence of six

organic compounds. Nine soil samples collected, between one and sixteen feet below grade, were analyzed for the presence of eight RCRA metals. Each analyte (except barium) was reported at non-detectable concentrations in each sample. Barium was reported at concentrations ranging between 0.1 and 1.0 mg/L. The soil pH was reported to range between 6.5 and 8.4 units (Reference K 353).

5.15.3 Regulatory Status of Unit

This SI is a wastewater holding pond which is regulated by the NDEP in conjunction with KMCC's NPDES Discharge Permit (NV0000078) (Reference K020, K158A). KMCC has been monitoring the WC-1 SI since it was placed into operation in March 1989 (Reference K342, UE041-UE057).

In accordance with the requirements of the discharge permit, KMCC conducts a series of visual inspections to assess the status of double-lined SIs. The general chemical analyses of waste streams and a description of the waste streams received by each SI are reported in annual monitoring reports submitted to the NDEP (Reference K158A, K305, K320). Records of routine liquid level and visual observations are maintained at KMCC for review by NDEP (Reference K357).

5.15.4 Waste Constituent Migration Pathways

The migration pathways are the surface soils in the event of a surface spill, the material between the liners from a leak in the top liner, the subsurface soils from a leak through the secondary liner, and possibly shallow groundwater.

5.15.5 Evidence of Releases and Potential Environmental Impacts

Indications of releases of liquids from the WC-1 SI were not observed during the SR. Indications of small releases were noted adjacent to the east corner of a pump unit which services this SI and the adjacent SI (i.e. WC-2). An area of soil measuring approximately 5 feet by 10 feet appeared white and crusty adjacent to the pump unit. This impact was probably due to pump packing/seal leaks.

The Discharge Monitoring Reports (DMRs) reviewed by Kleinfelder included monthly DMRs from June 1990 through November 1991. These DMRs indicated no fluid was detected between the WC-1 liners (Reference UE041-UE057).

Additional documentation of historic releases from this SWMU was not found during this study.

5.15.6 Analysis of Release Prevention or Mitigation Measures

The release prevention methods include a double-liner system equipped with a leak detection monitoring system and control of discharge to the WC-1 SI to avoid subsurface releases and overfilling of the SI, respectively. The leak detection monitoring system, positioned between the two liners, serves as early warning of a release through the primary (top) liner.

5.16 WC-2 (WC-East) Surface Impoundment

5.16.1 Unit/Area Design and Operational History

This triple-lined wastewater surface impoundment (SWMU KMCC-016) was constructed within the former Trade Effluent settling pond area and is located near the east central portion of the fenced and guarded KMCC facility. The triple-liner system is comprised of a bottom liner constructed of a 40 mil. HDPE membrane; a side liner constructed of a 105 mil. polypropylene geotextile, HDPE drainage netting, and a 40 mil. HDPE membrane; a middle liner consisting of a 60 mil. HDPE membrane; and a top liner consisting of a 40 mil. HDPE membrane. The second top liner was installed as an ultraviolet (UV) protective liner because the original top liner (now the middle liner) did not meet KMCC's design specifications. That material was found to contain less than the specified carbon content after installation. The WC-2 SI has a surface area of 88,580 square feet and a capacity of 19,658,500 gallons. This SI was constructed with soil berms which stand approximately 10 to 12 feet above the surrounding area. This berm is approximately 25 feet wide, flat, and relatively level (Reference K158A, K320; SR, August 20, 1991).

This SI has a leak detection system between the bottom and middle liners. The leak detection system is comprised of monitoring pipes and conductivity detectors. Two,

four-inch diameter PVC monitoring pipes allow access to the low point in the bottom liner. These pipes are equipped with detectors to monitor for leaks through the top two liners (Reference K357).

The WC-2 SI was constructed in late 1988, placed into operation in December 1988, and is presently in use (Reference K334, K342; SR, August 20, 1991). The operating practices at this SI are similar to those for WC-1 and consists of receipt of a composite liquid waste stream from Units 3, 5, and 6 and the steam plant (Reference K158A). The solutions discharged to this SI are from the following sources (Reference K158A):

- o process water softeners;
- o steam generation blowdown;
- o cooling tower blowdown from Units 3 and 5;
- o manganese dioxide product wash solution from Unit 6;
- o process seal water/filter flush; and
- o concentrated brine from the vapor recompression units.

Solution from this SI is processed through vapor recompression units to reclaim water for cooling and process use (Reference K158A). The concentrated brine effluent is discharged to either the WC-1 or WC-2 SI.

This SI was observed during an August 20, 1991 SR. On that date, the SI had approximately six feet of freeboard. The SI was surrounded by a flat and relatively level berm approximately 25 feet wide and 10 to 12 feet higher than the surrounding area. Surface water run-off should be minimal from the top of the berms. Surface water run-on from the south would be diverted around the SI berms. Precipitation may cause minimal inflow from the top of the berms or the liner surface.

5.16.2 Unit/Area Waste Characteristics

This SWMU receives wastewater from Units 3, 5, and 6 and the steam plant (Reference K158A). This wastewater originates from the following sources: process water softeners; steam generation blowdown; cooling tower blowdown from Units 3 and 5; manganese dioxide product wash solution from the clarifier in Unit 6; process seal water/filter flush; and concentrated brine from the vapor recompression units (Reference K158A).

Sampling and analysis of the applicable waste streams are reported to the NDEP annually per the KMCC NPDES permit (Reference K158A). The chemical composition and average flow rate for waste streams directed to the WC-2 SI for 1990 are listed below in Table 5.16.1.

Table 5.16.1
1990 Annual Waste Stream Analysis

	<u>pH</u>	<u>Na</u>	<u>TDS</u>	<u>Ca</u>	<u>Mg</u>	<u>Mn</u>	<u>K</u>	<u>Average Flow</u>
Steam Plant Blowdown	9.9	0.36	1.24	0.030	0.018	n/a	0.011	8.9
RCC Composite	7.1	44	134.6	1.0	1.92	0.61	3.46	1.8

Units = pH in S.U., Average Flow in gpm, All other units in g/l, "n/a" indicates no analysis (Reference K305).

This composite waste stream exhibits a pH of approximately 7.1 to 10.2 (Reference K158A, K305, K320).

Prior to construction of WC-1 and WC-2 within the former Trade Effluent settling pond area, soil samples were collected from two areas and analyzed by EP Toxicity procedures. Two near surface soil samples were analyzed for the presence of six organic compounds. Nine soil samples, collected between one and sixteen feet below grade, were analyzed for the presence of eight RCRA metals. Each analyte (except barium) was reported at non-detectable concentrations in each sample. Barium was reported at concentrations ranging between 0.1 and 1.0 mg/L. The soil pH was reported to range between 6.5 and 8.4 units (Reference K353).

5.16.3 Regulatory Status of Unit

This SI is a wastewater holding pond which is regulated by the NDEP in conjunction with KMCC's NPDES Discharge Permit (NV0000078) (Reference K020, K158A). KMCC has been monitoring the WC-2 SI since it was placed into operation in December 1988 (Reference K342, UE041-UE057).

In accordance with the requirements of the NPDES permit, KMCC conducts a series of visual inspections to assess the status of SIs constructed with multiple liners. The general chemical analyses of waste streams and a description of the waste streams received by each SI are reported in annual monitoring reports submitted to the NDEP (Reference K158A, K305, K320). Records of routine liquid level and visual observations are maintained at KMCC for review by NDEP (Reference K357).

5.16.4 Waste Constituent Migration Pathways

The potential migration pathways are the surface soils in the event of a surface spill, the material between the liners from a leak through the top two liners, the subsurface soils from a leak through the secondary liner, and possibly shallow groundwater.

5.16.5 Evidence of Releases and Potential Environmental Impacts

Indications of releases of liquids from the WC-2 SI were not observed during the SR. Indications of small releases were noted adjacent to the east corner of a pump unit which services this SI and the adjacent SI (i.e. WC-1). An area of soil measuring approximately 5 feet by 10 feet appeared white and crusty adjacent to the pump unit. These localized impacts are probably due to pump packing/seal leaks.

The Discharge Monitoring Reports (DMRs) reviewed by Kleinfelder included monthly DMRs from June 1990 through November 1991. These DMRs indicated fluid was not detected between the WC-2 liners (Reference UE041-UE057).

5.16.6 Analysis of Release Prevention or Mitigation Measures

The release prevention methods include a triple-liner system equipped with a leak detection monitoring system and control of discharge to the WC-2 SI to avoid subsurface releases and overfilling of the SI, respectively. The leak detection monitoring system, positioned between the top two liners and the bottom liner, serves as early warning of a release through the primary (top two) liners.

5.17 Ammonium Perchlorate (AP) Area - Pad 35

5.17.1 Unit/Area Design and Operational History

Pad 35 (SWMU KMCC-017) is an accumulation point for drummed, nonhazardous, solid, industrial waste. This pad is located in the central portion of the fenced and guarded KMCC facility, approximately 20 feet south of the building known as Old D-1 (Reference Map 17). The construction features of this accumulation point consist of an "L" shaped concrete pad approximately 30 feet long by 12 feet wide. The "foot" of the "L" shaped pad is in the southwestern corner and comprises an additional approximately six by ten foot area. Lines are painted on the pad and stenciled names are present denoting the type of waste to be placed in each area. The pad is not equipped with berms and is surrounded on all sides by soil (Reference K161; SR, August 20, 1991).

This pad has been in use since 1989. Between 1980 and 1989, the common trash from the AP, chlorate, and perchlorate process areas were transported to the trash storage area north of Units 1 and 2 (i.e. SWMU KMCC-002). In 1989, this area (Pad 35) was designated as a separate accumulation area for: (1) common trash potentially contaminated with AP, and (2) other industrial wastes (Reference K357).

An SR was conducted on August 20, 1991. On that date, the painted lines delineating the various storage areas and the stenciled signs for AP trash, iron oxide, and desiccant bags were clearly legible. Cracks and other signs of deterioration of the concrete pad were observed. Numerous sealed drums were positioned on the pad. Several drums were positioned on the soil surface to the south of the concrete pad. The drums positioned off the pad were labeled "Cooling Tower Sludge", "Calcined Packing Material", and "Iron Oxide Sludge".

This SWMU appeared adequate in size for storage of several drums. However, many of the drums present in this area were not stored on the pad. Surface water run-on to the pad would be from the southeast and southwest. Run-off from this SWMU would be toward the soil on the north side of this area.

5.17.2 Unit/Area Waste Characteristics

The specific wastes temporarily accumulated at this SWMU consist of drummed, nonhazardous, solid industrial waste. This waste is comprised of common trash and desiccant bags potentially contaminated with ammonium perchlorate; iron oxide sludge generated at the groundwater remediation unit (SWMU KMCC-019); cooling tower sludge; and calcined packing insulation. The waste originating from the ammonium perchlorate process area, although not hazardous waste, is drummed, sealed, labeled, and shipped off-site to the U.S. Ecology, Inc. landfill in Beatty, Nevada for disposal as a precaution because of a potential fire hazard (Reference SR, August 20, 1991; K357).

Solid samples of the iron oxide sludge from the groundwater remediation unit were analyzed in March 1990 for concentrations of total soluble chromium by both the TCLP and EP TOX methods. The analytical results indicate this material contains less than 5.0 mg/L total soluble chromium (Reference K318). However, KMCC utilizes the Beatty, Nevada facility for disposal of this material as a precautionary measure.

5.17.3 Regulatory Status and of Unit

KMCC has designated this area for storage of nonhazardous, solid industrial waste. Kleinfelder did not find documentation regarding any special regulatory status for this area.

5.17.4 Waste Constituent Migration Pathways

The migration pathways at this SWMU include spillage/leakage of waste from the drums to the surface of the concrete pad and adjacent soil. The amount of hazardous constituents or wastes from these sources is minimal and impacts are not expected to be detectable.

5.17.5 Evidence of Releases and Potential Environmental Impacts

Crystalline material was observed at a few small areas on the concrete pad. This material possibly consists of ammonium perchlorate or sodium chloride. Crystalline material was also observed as a growth around the sealed top of one drum positioned on the soil adjacent to the southwestern portion of the pad and was also observed on the soil at the base of this drum. These drums were labeled "Calcined Packing Insulation".

Some of these crystals have a decided reddish tint, probably due to the iron oxide derived from the drum surface. The salt crystals on the pad appeared to be similar to those on the drum (Reference SR, August 20, 1991).

Documentation of historic releases from this SWMU was not found during this study.

5.17.6 Analysis of Release Prevention or Mitigation Measures

The wastes routinely stored at this SWMU are typically contained in drums. The release prevention methods employed at this SWMU include: the containerization of waste prior to delivery to the site; the segregation of the waste into separate handling areas; and securely sealing the stored drums. The overall appearance of this SWMU suggests relatively good housekeeping practices are employed. However, the drums which were observed to be temporarily stored on the soil surface adjacent the southern side of this SWMU should be stored on the concrete surface.

5.18 Drum Crushing Area

5.18.1 Unit/Area Design and Operational History

The drum crushing and recycling area (SWMU KMCC-018) is located within the fenced and guarded KMCC facility approximately 160 feet east of Building Old D-1 and approximately 40 feet north of the toe of the berm surrounding the AP-5 SI (Reference Map 18). This SWMU consists of a hydraulic drum crusher positioned on a concrete pad. The pad is approximately 18 feet long by 18 feet wide, covered by a roof, and open on four sides. The concrete pad is not equipped with run-on/run-off control berms (Reference SR, August 20, 1991).

The AP drum crusher has been in operation since 1984. The drums are typically rinsed in the AP process areas, after they have been emptied of product. The empty steel drums are delivered to this area and temporarily stored on the soil surface adjacent to the crusher. After crushing, the drums are recycled as scrap metal (Reference K357).

It is believed that prior to approximately 1973, the drums were disposed of in the BMI landfill (Reference K357). Drums and portions of drums began to be recycled as scrap steel through off-site companies in approximately 1973.

An SR of this area was conducted on August 20, 1991. On that day, approximately 300 drums were observed temporarily stored on the soil in the vicinity of the crusher,

waiting to be crushed, and approximately 50 crushed drums were stored immediately north of the crusher. A cursory review of some of the drums revealed that most were free of product and only a few contained some small amounts of crystalline residue. Evidence of product was not noted on the concrete pad.

Surface water run-on could flow onto and around the concrete pad from the south. Run-off would flow to the north through the drum storage area, continue for a short distance, and then exit this area to the east along an adjacent asphalt surfaced road.

5.18.2 Unit/Area Waste Characteristics

The specific wastes managed at this SWMU are empty, metal 55-gallon DOT 17-H drums which originate in the AP process area. The drums are classified as nonhazardous solid waste destined for recycling.

Some drums may contain small quantities of residual chlorates/perchlorates which are soluble in water.

5.18.3 Regulatory Status of Unit

Kleinfelder did not find documentation regarding any special regulatory status for this area. However, this SWMU appeared to be operated in conformance with operating practices for nonhazardous solid waste destined for recycling.

5.18.4 Waste Constituent Migration Pathways

Because the drums are typically rinsed prior to delivery to this area, the possibility of residual constituents to migrate and impact the surrounding environment is reduced.

5.18.5 Evidence of Releases and Potential Environmental Impacts

Small quantities of white crystalline deposits were observed on the soil slightly north west of the crushing area and adjacent to an asphalt road. This material did not appear

to be associated with this SWMU and is likely ammonium perchlorate, salt, or another product spilled during other material transfer operations in the area (Reference SR, August 20, 1991). Documentation of historic releases from this SWMU was not found during this study.

5.18.6 Analysis of Release Prevention or Mitigation Measures

The release prevention method related to this SWMU is the rinsing of the drums in the AP process areas prior to delivery to this area.

This SWMU appeared adequate in design for the crushing of drums. The operating practices could be modified to further reduce the possibility of release to the environment. Management inspection of drums prior to delivery to this unit is one method which may reduce the possibility of release to the environment.

5.19 Groundwater Remediation Unit

5.19.1 Unit/Area Design and Operational History

SWMU KMCC-019 is a groundwater remediation unit which intercepts and treats a plume of chromium contaminated shallow groundwater from beneath the KMCC property. This area is located in the central portion of the fenced and guarded KMCC property, approximately 2,400 feet north and downgradient of process areas in the Unit 1 through 6 buildings (Reference Map 19).

This SWMU has been in operation since September 1987 and occupies an area approximately 1,200 feet long east-west by 650 feet wide north-south. This SWMU consists of a line of 11 groundwater interceptor wells approximately 900 feet long, two downgradient groundwater recharge trenches for management of treated groundwater, numerous monitoring wells, and a groundwater treatment unit. The groundwater treatment unit electrolytically reduces chromium and other heavy metals and precipitates them as iron oxide sludge. This treatment system is designated with a sign and comprises an electrolysis unit, tanks, pumps, filter presses, a clarifier, a sump, and other equipment which are situated on a concrete pad. This concrete pad is approximately 60 feet long east-west by 20 feet wide north-south and is located in the western portion of this SWMU. The pad has concrete berms on the north, east, and west sides and is open to the south side. The concrete berms are approximately eight inches thick and range from four to eight inches high. The pad is sloped to a sump in the northeast corner and away from the unbermed side (Reference K304; SR, August 20, 1991).

The following paragraphs provide background information regarding why this groundwater remediation system was constructed, the design criteria, and how it has been operated.

The production of sodium chlorate occurred in Units 4 and 5 from 1945 to November 1989 (Reference Plate 3-2). Additionally, the eastern portion of Unit 5 has been used to produce sodium perchlorate from 1945 to present. The sodium chlorate and sodium perchlorate processes utilize sodium dichromate (hexavalent chromium) in the process solutions to aid the electrolytic process (Reference CA017).

Process liquors, spillage, and washwater from the sodium chlorate and sodium perchlorate processes were caught in the basements of Units 4 and 5 and were subsequently pumped and removed from the basements. These materials were either returned to the process or managed as effluent. Deterioration and cracking of the concrete basement floors resulted in release of chromium bearing chlorate process liquids to the underlying soils and groundwater. Consequently, the shallow groundwater beneath portions of the site has been contaminated with chromium (Reference K091).

As a result, identification and clean up of the chromium contaminated groundwater was initiated by KMCC based on a September 9, 1986 NDEP Consent Order (Reference K304). KMCC has operated a chromium remediation system since September 1987 in compliance with the September 9, 1986 Consent Order (Reference ND006). The following paragraphs provide background on this remediation system.

A series of groundwater monitoring wells were installed on the KMCC site in 1981 and 1982 to monitor RCRA "regulated units", SI S-1, SI P-1 and the hazardous waste landfill. These units are now certified closed by NDEP (Reference K079, K084, K167). Groundwater monitoring results indicated chromium was present in the shallow groundwater beneath portions of the site (Reference K084). Several additional groundwater monitoring wells were installed and the source and extent of the chromium contamination was traced to the basements of Units 4 and 5 (Reference K091).

In 1985, KMCC completed a "Hydrogeological Investigation" (Reference K167) which provided the basis for an evaluation of the location and design of a groundwater intercept, treatment, and recharge system (Reference K304). The 1985 hydrogeological report revealed that Units 4 and 5 were identified as the source areas of chromium impact to the "Near-Surface" groundwater and that actions had been taken to eliminate further leakage (Reference K167). These initial actions included concrete sealing and repair in the basements and initial pumping of groundwater from monitoring well M-3 in 1983 and 1984 (Reference K091, K092, K105, ND049). Additionally, the 1985 hydrogeological report indicated that the chromium plume had migrated at least 4,000 feet downgradient (to the north) from the point of leakage.

This plume was further described as "typically narrow" because migration was occurring primarily through a narrow, buried stream "channel fill" deposit (Reference K167).

On September 9, 1986 KMCC entered into a Consent Order with the NDEP to remediate chromium contamination in the groundwater beneath the site (Reference K304). The Consent Order required KMCC to:

- o design, construct and operate a groundwater intercept system;
- o monitor the effectiveness of the intercept system;
- o install a chromium treatment system;
- o design, construct and operate an underground disposal system (recharge system); and
- o provide monitoring wells to measure the impact of the recharge system on groundwater levels and groundwater quality.

The groundwater interceptor system installed by KMCC is located approximately 600 feet north and downgradient of the AP surface impoundments. The basis for installing the recovery system in this area was to intercept shallow groundwater with high chromium concentrations in an area which exhibits favorable hydrogeological properties. This system is designed to intercept groundwater having chromium concentrations greater than 5.0 mg/L (Reference K304).

The interceptor system is comprised of 11 groundwater intercept wells; identified as I-A through I-K. The intercept system is approximately 1,600 feet long, trends in an east-west direction, and was designed to cross the width of the chromium plume (Reference K304).

KMCC also installed approximately 9 groundwater monitoring wells (within the area of the trough of depression created by operation of the intercept system) to monitor the effectiveness of the intercept system. Groundwater level readings obtained from these wells are used to evaluate the effectiveness of the intercept system (Reference K304).

An electrochemical reduction process was chosen as the method for removal of chromium from the groundwater. The electrochemical process reduces hexavalent

chrome to trivalent chrome. The process generates ferrous ions from the use of iron electrodes thus producing an iron oxide precipitate containing reduced heavy metals. The system was designed to meet the NDEP required effluent requirements (hexavalent chrome concentration of <0.05 mg/L and total chrome concentrations of <1.7 mg/L) with the following maximum feed quantities/characteristics (Reference K304):

- o hexavalent chrome 10 mg/L;
- o total chrome 10 mg/L;
- o pH 7 - 8; and
- o flow 100 gallons per minute.

The treated groundwater recharge system constructed by KMCC is located approximately 250 feet downgradient (north) of the interceptor line. The recharge system consists of two parallel, roughly east-west trending, recharge trenches. The trenches are located approximately 75 feet apart from one another. The southern trench (primary recharge trench) is approximately 1,100 feet long whereas the northern trench (auxiliary trench) is approximately 800 feet long (Reference K303, K304).

Groundwater monitoring wells used to evaluate the impact of the recharge system on groundwater levels consists of a series of wells located: (1) upgradient of the recharge system, (2) within the immediate vicinity of the recharge system, and (3) downgradient of the recharge system. Groundwater level changes in the wells located in the vicinity of the recharge system represent maximum impact to groundwater elevation. Groundwater level changes in the downgradient wells are compared to groundwater level changes in the upgradient wells. Corresponding rises or declines are attributable to a regional rise or decline in groundwater elevation. Differences in elevation change represent the impact of the recharge system on groundwater elevations (Reference K304).

KMCC chose five monitoring wells to sample periodically and analyze for chromium concentrations as a means to monitor the groundwater quality. The five wells (termed Appendix J wells) are located along the center line of the chromium plume, and extend from near the chromium contaminations source (Units 4 and 5) to near a northeast

corner of the KMCC property boundary (approximately 600 feet north of WC-1 surface impoundment). Evaluation of the chromium concentration in groundwater samples collected from these monitoring wells enables KMCC to evaluate the effectiveness of the groundwater clean-up program (Reference K304).

The effectiveness of the chromium groundwater remediation program is evaluated through periodic monitoring and analysis of groundwater at specific groundwater monitoring wells (identified in the September 9, 1986 Consent Order) and effluent from the chromium treatment system. The data obtained is summarized in performance reports which are distributed to the NDEP on a quarterly or semi-annual basis (Reference K303, K304).

During the first quarter of 1988, physical modifications to the groundwater treatment plant were made to increase its efficiency and reliability. An additional electrolytic cell was added to the treatment plant to preclude extended shutdown during cleaning and replacement of electrodes (Reference ND010).

In general, by the first quarter of 1989, the rate of decline in the groundwater level throughout the Consent Order monitoring area (which had been dropping each quarter) had essentially stabilized (Reference ND002). By the fourth quarter of 1989, the groundwater level within the majority of the interceptor wells was at or below the surface of the Muddy Creek Formation (Reference ND039).

An SR of the groundwater treatment unit was conducted on August 20, 1991. On that date, the area of the SWMU was clear of debris and well maintained. Cracks, cold joints, and other types of deterioration of the concrete containment pad and berms were not observed. The area surrounding the concrete pad was comprised of soil. On the day of the SR, sludge was present on the concrete floor of the SWMU beneath the degassing unit. This one time cleanout of nonhazardous filter cake from the degassing unit consisted of opening the unit and allowing the filter cake to fall to the floor. The water drains from the filter cake into the containment recovery sump. This water is recycled into the treatment system. The filter cake is allowed to dry and is then shoveled into drums. The drums are closed and placed with other nonhazardous filter cake material for transport to SWMU KMCC-017 and eventual off-site disposal.

Iron oxide from the filter press was stored in drums in the southeastern corner of the treatment unit. Small quantities of the iron oxide had spilled onto the soil surface adjacent to the south side of the pad. Some of the iron oxide sludge had also spilled over the berms on the north side of the containment pad and onto the adjacent soil surfaces. The iron oxide has been tested using EP Toxicity methods and shown to have nonhazardous concentrations of total chromium.

Stormwater would flow toward the SWMU from the south and be diverted around the unit to the east or west, therefore, there would be no run-on. The concrete pad slopes gently toward the north allowing water which falls onto the pad, or water generated from equipment washdown, to be collected in the sump along the north berm and recycled back into the treatment system.

5.19.2 Unit/Area Waste Characteristics

The specific waste generated at the SWMU is iron oxide sludge and filter cake which contains chromium. Solid samples of the iron oxide filter cake (sludge) were analyzed in March 1990 for concentrations of soluble chromium by both the EP Toxicity and TCLP test methods. The results of these analyses indicated a concentration of 0.94 mg/L by EP TOX and 2.5 mg/L by TCLP methods. These analytical results showed this material leached significantly less than the regulatory standard (40 CFR 261.24) of 5.0 mg/L total chromium (Reference K318). KMCC manages this material as nonhazardous waste. The iron oxide is containerized in drums and transported to SWMU KMCC-017 where they await off-site disposal (Reference K357; SR, August 20, 1991).

5.19.3 Regulatory Status of Unit

This SWMU is regulated under a consent agreement between KMCC and NDEP dated September 9, 1986 (Reference K304). Results of the system's performance and the chemical analyses of treated groundwater are reported to the NDEP in semi-annual performance reports (such as Reference K303).

The "Chromium Mitigation Program" has been in effect for approximately 4 years. KMCC concluded the following in a recent performance report, dated July 26, 1991 (Reference K303):

- o effective groundwater interception and treatment are being attained;*
- o the effect of changing the pumping rates of the interceptor wells will continue to be monitored, and appropriate responses (i.e.-future pump rate adjustments) will be taken to assure optimal drawdown and plume interception;*
- o discharge chromium concentrations for the treatment facility are below established requirements;*
- o groundwater samples obtained from monitoring wells downgradient of the recharge trenches show that groundwater is being remediated; and*
- o no adverse impacts to downgradient groundwater levels have been observed as a result of returning treated groundwater to the near-surface aquifer via the recharge trenches.*

Analysis of the activities and conclusions included within the July 26, 1991 performance report reveal the following (Reference K303):

- o groundwater within the interceptor wells has been drawn down to levels at or below the base of the Muddy Creek Formation. However, the cones of depression are steep and overlapping drawdown cones are not indicated throughout the entire length of the intercept line (Reference Figure B-4, Interception Areas I-B through I-C, I-E through I-F, and I-H through I-K). Therefore, it appears that some chromium contaminated groundwater is not captured by the interceptor wells;*
- o appendix J well M-72 (one of five wells in which groundwater samples are designated to be analyzed for chromium according to the September 9, 1986 Consent Order), is located downgradient of the interceptor system and upgradient of the recharge system. This well has shown an increase in total chromium concentrations between December 1988 and June 1991;*
- o in May 1990 KMCC began to monitor wells M-71 and M-73 for chromium contamination. These wells are located downgradient of the interceptor system and upgradient of the recharge trenches. From May 1990 to June 1991, these wells have shown an increase in total chromium concentrations; and*
- o in May 1990 KMCC also began to monitor wells M-84 and M-88 for chromium contamination. These wells are located downgradient/oblique gradient of the recharge system respectively. From May 1990 to June 1991, monitoring well M-84 revealed decreasing concentrations of total chromium and monitoring well M-88 showed a slight increase in total chromium concentrations. This data appears to show that the groundwater interceptor and treatment systems are reducing chromium concentrations in groundwater to concentrations less than the discharge criteria.*

In general, data obtained as part of the chromium remediation program indicates the intercept system is capturing much of the chromium contaminated groundwater and the treatment system is effectively reducing chromium concentrations to below established requirements for total chromium (Reference K303).

Prior to the implementation of the chromium groundwater remediation program, chromium concentrations in groundwater ranged from approximately 90 mg/L near the source at Units 4 and 5 to less than 1.0 mg/L near a northeast corner of the property boundary (approximately 600 feet north of WC-1 surface impoundment). The chromium plume had migrated approximately 4,000 feet downgradient from its source at Units 4 and 5 (Reference K167).

The chromium groundwater remediation system was implemented in 1987. Concentrations downgradient of the remediation system appear to be decreasing and environmental impacts to the groundwater downgradient of the recharge system appear to be low (Reference K303).

5.19.4 Waste Constituent Migration Pathways

Shallow groundwater contaminated with chromium is intercepted and treated by the installed system. 1991 analysis of the treated water recharged to the shallow groundwater downgradient of the interceptor system indicates that total chromium concentrations in this water are less than the established consent order requirements (Reference K303).

The iron oxide sludge and filter cake generated by the groundwater treatment unit may migrate to the surface soils if a spill occurs outside of the containment berms.

5.19.5 Evidence of Releases and Potential Environmental Impacts

In a July 1991 performance report, KMCC concluded that effective groundwater interception and treatment are being attained. Although the water level in the interceptor wells is drawn down to levels below the base of the Muddy Creek Formation, full overlap of the cones of depression may not be complete. Therefore, it appears that some chromium contaminated groundwater may not be captured by the system. Leakage through the interceptor system, however, would be diluted at the recharge trenches and the NDEP requirements for chromium concentration downgradient of the remediation system would be met (Reference K303).

A small quantity of iron oxide sludge was noted outside the bermed area on the soil north of the groundwater treatment unit and a small quantity of iron oxide filter cake was observed spilled onto the soil south of the groundwater treatment unit. This waste, however, is insoluble and contains nonhazardous concentrations of chromium (Reference K318).

5.19.6 Analysis of Release Prevention or Mitigation Measures

A series of groundwater monitoring wells are included in this SWMU as a monitoring system to evaluate the effectiveness of the chromium remediation program.

In general, data obtained as part of the chromium remediation program indicates the intercept system is capturing much of the chromium contaminated groundwater and the treatment system is effectively reducing chromium concentrations to below established requirements for total chromium (Reference K303, K304).

5.20 The Beta Ditch

5.20.1 Unit/Area Design and Operational History

The Beta Ditch is an unlined east-west drainage which extends through KMCC, Timet, and BMI property. The following paragraphs present information related to the entire course of the Beta Ditch. However, for the purpose of defining the Beta Ditch as a KMCC SWMU, only the portion which occurs on KMCC property has been considered as KMCC SWMU-020. Remaining portions of the Beta Ditch are more appropriately addressed by the applicable landowners.

The Beta Ditch was constructed in approximately 1941 or 1942 during construction of the BMI complex by the U.S. Government. This unlined ditch originated at a storm sewer outfall located just northwest of the current KMCC AP maintenance shop (Reference Map 20). From this point, the Beta Ditch extended to the east (beyond the current KMCC property boundary) to a siphon location currently controlled by Timet. This drainage ditch was extended westward in 1970 to allow Stauffer and Montrose wastes to be transmitted through the Beta Ditch. The siphon transmitted flows under Boulder Highway to another unlined open surface ditch (The "Acid Ditch") which paralleled the southern margin of the upper BMI ponds. Flows were then routed to ponds within the upper or lower BMI pond system via a distribution ditch within the pond system (Reference K056, K061, K161, K164, UE104).

The Beta Ditch has been used for two primary purposes:

- o pre-1976: management (transfer) of a variety of liquid and slurried wastes originating from U.S. Government operations, the various operating companies and lessees between 1941/1942 and 1976. These wastes and stormwater run-off were transmitted to the upper and lower BMI ponds; and
- o post-1976: management of non-contact cooling water and stormwater run-off periodically between January 1976 and present. These non-industrial effluents have been transmitted to the Las Vegas Wash by the Alpha Ditch or Pittman bypass pipeline (Reference K158A, UE060).

The flows periodically transmitted through the KMCC portion of the Beta Ditch prior to January 1976 included the following:

- o magnesium related waste streams from the production of magnesium by the U. S. Government between 1941/1942 and 1944 (Reference K164);
- o chlorate, perchlorate, and boron process wastes and related waste streams from cooling tower blowdown, boiler blowdown, and housekeeping washings generated by KMCC (and its predecessors) and their tenants between 1947 and 1976 (Reference K037, K039, K056);
- o stormwater run-off from throughout much of the southern portion of the BMI complex between 1941/1942 and 1976 (Reference K056, K178, K265);
- o Stauffer and Montrose waste streams from 1970 to April 1, 1976 (Reference UE091, UE104);
- o effluent from the U.S. Lime and Flintkote facility (now owned and operated by Chemstar) (Reference K265, UE072); and
- o waste streams from the State Industries lease area from approximately 1969/1970 through 1974 and area stormwater run-off from 1969 through present (Reference K263, K265, K302, UE103, UE114).

Between 1971 and January 1976, KMCC progressed through institution of a "zero discharge" industrial wastewater effluent program (Reference K347). From January 1976 to present, the KMCC portion of the Beta Ditch has been used to transmit the following materials to the Las Vegas Wash:

- o stormwater run-off from throughout the southern portions of the KMCC property including various lease areas (Reference K178, K158A);

- o once through, non-contact cooling water from KMCC operations (Reference K056, K158A);
- o periodic discharges from the old main cooling tower (between January 1976 and October 1989) resulting from recirculation water upsets (Reference K034, ND048, UE033);
- o effluent from the Flintkote facility (now owned and operated by Chemstar) until a reclaim tank was installed in 1979 (Reference UE072; and
- o Stauffer and Montrose waste streams prior to April 1, 1976 when these companies also attained "zero discharge" for industrial wastewater (Reference UE091, UE104); and
- o periodic stormwater run-off from throughout the Stauffer (now Pioneer) portion of the BMI facility (Reference UE060, UE063, UE076).

An SR of the Beta Ditch was conducted on September 20, 1991. On the day of the SR, the Beta Ditch was generally clear of debris and well maintained. The "Stauffer extension" of the Beta Ditch which extends the ditch approximately 800 feet from KMCC's western property boundary to the point of confluence with the Beta Ditch was also clear of debris.

On the eastern portion of the property, the Beta Ditch is joined by a small diversion ditch just northwest of the corner of surface impoundment C-1 (Reference Map 20). This diversion ditch, also considered part of the Beta Ditch system, receives stormwater run-off from the manganese tailings area (SWMU KMCC-009) and historically received water from the old cooling tower upsets until the cooling tower was removed from service in September 1989. The SR of this diversion ditch was performed on August 20, 1991. The diversion ditch was lined with broken concrete and metal parts of cells (rip-rap) to reduce bank erosion.

The average width of the Beta Ditch was approximately 6 to 7 feet. The banks were sloped at approximately 1-1/2: 1 horizontal to vertical. The average depth of the Beta Ditch varied from 3-1/2 to 4-1/2 feet on the western portion of the property to 2 to 3-1/2 feet on the topographically lower eastern portion of the property before convergence with the diversion ditch northwest of surface impoundment C-1. East of this convergence point, the northern bank of the Beta Ditch was approximately 2-1/2

feet high whereas the southern bank was approximately 7 to 8 feet high. The diversion ditch was approximately 1 to 1-1/2 feet deep, had irregular bank heights and slopes, and averaged approximately 5 feet of bed width in most places.

Evidence of flows through the ditch were characterized by scour marks and light colored sediment and salt-like deposits throughout the majority of the Beta Ditch. Evidence of overtopping or other flooding of the Beta Ditch system was not observed.

5.20.2 Unit/Area Waste Characteristics

The Beta Ditch has been used since 1941/1942 for the transmission of various waste streams and storm water run-off. Between 1941/1942 and present, use of this drainage and the types of waste conveyed have changed as noted previously. The following is a summary of known waste streams conveyed through the KMCC portion of the Beta Ditch.

U.S. Government Operations - 1941/1942 to 1944

Kleinfelder did not find documentation describing the chemical composition of waste conveyed through the Beta Ditch during the U.S. Government operations era. This drainage was used to convey "Trade Effluent" wastes to the upper and lower BMI ponds. This waste included both acid effluent and waste caustic liquor which was formerly disposed of in the Trade Effluent evaporation/settling ponds (Reference Doc. K164; UL020).

KMCC (and Predecessors) 1945 to 1976

From 1945 to January 1976, the Beta Ditch was used as the primary means to convey aqueous process wastes to the upper and lower BMI ponds (Reference K056). The aqueous waste did not contain manganese dioxide process wastes; however, it did contain waste effluents from the following processes (Reference K037):

- o sodium chlorate (1945-1974/1976)
- o potassium chlorate (1945-1974/1976)
- o sodium perchlorate (1945-1974/1976)
- o potassium perchlorate (1945-1974/1976)

- o manganese perchlorate (1969-1974/1976)
- o ammonium perchlorate (1951-1974/1976)
- o boron processes (1972-1974/1976)

Prior to January 1976, the average combined volume of effluent from the above processes that was discharged to the Beta Ditch (based on a 1970 NPDES report) was approximately 600,000 gallons per day (Reference K037). The average content of this combined effluent, estimated by mass balance methods, is shown on the following table.

**TABLE 5.20.1
 AVERAGE DISCHARGE TO BETA DITCH (Pre 1976)
 (Reference K037)**

<u>Parameter</u>	<u>Mass Flow</u>	
Total Dissolved Solids	19,100	pounds/day
Total Solids	20,200	pounds/day
Suspended Solids	1,080	pounds/day
C.O.D.	110	pounds/day
NH ₃	35	pounds/day
Calcium	2,000	pounds/day
Iron	1,100	pounds/day
Potassium	1,200	pounds/day
Sodium	5,000	pounds/day
Magnesium	150	pounds/day
Zinc	130	pounds/day
Manganese	1,800	pounds/day
Nickel	8	pounds/day
Lead	4	pounds/day
Copper	4	pounds/day
Cobalt	1.5	pounds/day
Chromium	0.3	pounds/day
Phosphorous	0.4	pounds/day

In addition to the process effluents, the Beta Ditch flows also included liquids from cooling tower blowdown, boiler blowdown, housekeeping washings, storm drains, (See Section 5.30) acid drains (See Section 5.31) and once through cooling water (Reference K056). Housekeeping washings not returned to the process were discharged to the storm drains or acid drains. These units are designed SWMUs KMCC-030 and -031, respectively. They are discussed in Section 5.30 and 5.31.

In January 1976, KMCC achieved a "zero discharge" industrial wastewater effluent status wherein the Beta Ditch was no longer used to routinely convey industrial wastes (Reference K347).

Other Operating Companies and Tenants 1945 to 1976

This drainage also conveyed waste streams from Stauffer and Montrose operations between 1970 and April 1976 (Reference UE091, UE104). U.S. Lime or Flintkote (operating at the facility now owned and operated by Chemstar) also contributed to flows to the Beta Ditch prior to 1979 (Reference K265, UE072). Detailed documentation regarding the composition of their wastes was not found during this study.

This drainage also conveyed waste streams from some of KMCC's lessees including State Industries. Between June 1970 and September 1972, State Industries discharged approximately 35,000 gallons of liquid process waste per month to the Beta Ditch through the acid drain system (Reference UE103). This material consisted of approximately 2,500 gallons of spent sulfuric acid, 300 pounds of borax, 500 pounds of soda ash, and 4,000 pounds of phosphate chemicals each month (Reference UE103). State Industries also discharged process waste to the acid drain system on three occasions between June 7 and December 10, 1974 during surface impoundment repairs (Reference K298, K300, K301). Additionally, State Industries discharged neutralized and un-neutralized cyanide solutions (containing approximately 176 pounds of cyanide) to the Beta Ditch through the acid drain system between June 1970 and October 1971 (Reference UE103, UE114). Normally, this waste was mixed with a calcium hypochlorite solution prior to discharge (Reference K302).

KMCC 1976 to Present

Following achievement of the "zero discharge" industrial wastewater effluent status by KMCC in January 1976, the Beta Ditch has been used primarily to routinely convey only storm water run-off and once through, non-contact cooling water to the Las Vegas Wash (Reference K056, K158A, K178, K347). Between January 1976 and October 1989, periodic upsets associated with the old main cooling tower were also discharged to the Beta Ditch. Discharges from the cooling tower would contain elevated concentrations of salts naturally present in the feed water (Reference K326, K327, K329, K330, K331, K347, UE033).

Other Operating Companies and Tenants 1976 to Present

Following initiation of a "zero discharge" effluent program by Stauffer and Montrose on April 1, 1976, the Beta Ditch routinely received storm water run-off from these areas of the BMI facility (Reference UE063, UE080, UE091).

5.20.3 Regulatory Status of Unit

Early discharges to the Beta Ditch were unregulated. The NDEP began to regulate discharges to this drainage when the NPDES program was initiated in the early 1970s.

Lined surface impoundments were constructed on-site by KMCC and used for the management of process and waste fluids from 1972 to present (Reference K003, K013, UE030). Routine industrial waste discharges to the Beta Ditch were ceased by KMCC by January 1976 with diversion of these discharges to lined on-site surface impoundments (Reference K347). Current discharges to the Beta Ditch are regulated by the NDEP through NPDES permits including KMCC's (NV0000078) and are reported to the NDEP in monthly discharge monitoring reports (Reference K158A).

5.20.4 Waste Constituent Migration Pathways

Each of the migration pathways (air, soil, surface water, and groundwater) could have been involved with the Beta Ditch.

Air releases could occur (or could have occurred historically) if contaminated particles become airborne when the channel surface dried (Reference K170).

Releases to the soil have historically occurred based on the fact that the Beta Ditch is not lined. Waste stream constituents would have percolated into the soil and to groundwater. Migration of constituents to groundwater could still occur as the Beta Ditch is used to transmit stormwater run-off and once through cooling water (Reference K170).

5.20.5 Evidence of Releases and Potential Environmental Impacts

Releases to the soil are evident along the Beta Ditch. Based on the average content of the combined effluent waste stream as reported to EPA by KMCC (Reference Table

5.20.1), effluent percolating into the adjacent soils contained high concentrations of dissolved solids including various heavy metals such as chromium and lead (Reference K037). A water balance calculated by KMCC in 1982, using information provided by the U.S. Bureau of Reclamation and using 1981 as the base year, suggested that seepage from the Beta Ditch was approximately 100,000 gallons each day of use or roughly 3.5 percent of the solution transmitted (Reference K061).

Based upon this seepage capability, it is quite likely that infiltrating effluent reached groundwater.

Historic releases to the air may have occurred. Soil sampling conducted by Ecology and Environment (E & E) around the perimeter of the BMI complex indicated the presence of chromium above background concentrations in three off-site soil samples (Reference K179). The concentration of total chromium in two soil samples was reported at 12 and 17 ppm compared to a background concentration of 8 ppm (Reference K179). The location of these two samples was adjacent to the Boulder highway and within approximately 1/4 mile of the Beta Ditch. Based on the proximity of these locations to the Beta Ditch, it can be postulated that the presence of chromium at these locations may have come from facility activities.

Historic and future releases to surface water (the Las Vegas Wash) are possible. Residual contaminants, chiefly soluble salts, present in the Beta Ditch can be mobilized.

Review of the August 2, 1979 aerial photography revealed the presence of a yellow liquid effluent discharging from the western storm sewer outfall into the Beta Ditch and being conveyed to Las Vegas Wash (Reference K164). The source, nature and duration of this effluent discharge is not known.

5.20.6 Analysis of Release Prevention or Mitigation Measures

There are no historic or current release prevention measures associated with the Beta Ditch. The Beta Ditch remains unlined and stormwater run-off conveyed through this drainage can percolate into underlying soils. Additionally, releases to the air can occur when soils lining the Beta Ditch dry and winds mobilize this material.

The Beta Ditch flows are monitored for volume, pH and constituents as part of the various facility NPDES programs. The NPDES monitoring program appears to be adequate for documenting the quantity and quality of flows through the portion of the Beta Ditch controlled by KMCC during storm or release periods (Reference K158A).

5.21 Sodium Perchlorate Platinum By-Product Filter - Unit 5

5.21.1 Unit/Area Design and Operational History

This SWMU (KMCC-021) is a generation point for a platinum bearing filter cake which is a by-product from the sodium perchlorate process. This SWMU is located within the fenced and guarded KMCC facility and consists of a filter located adjacent to the southeast corner of Unit 5 and the adjacent drum storage area (Reference Map 21).

The design features of this area include a raised concrete pad, approximately 75 feet wide by 100 feet long, surrounded on four sides by 8-inch thick by 8-inch high concrete berms. The tops of the berms are approximately 2 to 2-1/2 feet above the surrounding asphalt paved area. The filter press, appurtenances, tanks and drum are located within this concrete bermed containment area. The sump is composed of concrete and was formed during the pouring of the entire containment pad. The sump is approximately 2 1/2 feet by 2-1/2 feet by 2 feet deep with a capacity of approximately 94 gallons. Liquid is lifted from the sump by a centrifugal pump with the inlet pipe positioned near the floor of the sump. A sump is located in the northeast corner of the containment area. Process liquids and washdown water accumulate in the sump and are returned by a pump system to the process. The filter containment area is within the process area which is further contained by berms at the north and south ends (Reference SR, August 20, 1991).

This filter press has been in operation since 1968. The operating practices in this area consist of filtering sodium perchlorate process solution before it is routed to the ammonium perchlorate plant. The filtering operation uses diatomaceous earth to filter solids from the sodium perchlorate solution. The filter cake, a process by-product, drops from the filter press into a hopper. This material is then loaded directly into drums within the containment area, or the filter hopper is transported by forklift to SWMU KMCC-007 for drying if damp or wet. The material is shipped in drums to an off-site precious metal recovery company because of the recoverable quantities of platinum contained in this by-product (Reference K335, K336, K337, K357).

An SR of this SWMU was conducted on August 20, 1991. On that date, the filter press was finished with a filtering run and a small quantity of filter cake was in the hopper beneath the filter press. Liquid was present on the pad and in the sump in the northeast corner of the containment area. The concrete floor had several former cracks which had been sealed. However, the sealant was in need of repair in a few of the cracks. The concrete berms appeared in good condition except for one seam in the vicinity of the sump which was weeping a small quantity of fluid onto the asphalt area outside of the SWMU.

Process liquids, washdown water, and precipitation which occurs within the bermed area would flow to the sump located in the northeast corner and be recycled into the process. Precipitation which occurs within the process area would be collected by another sump. Surface water run-on is prevented by the elevated design of this containment pad.

5.21.2 Unit/Area Waste Characteristics

The by-product resulting from the filtering operations in this area contains chiefly diatomaceous earth with traces of sodium chloride, sodium carbonate, calcium carbonate, some sodium perchlorate solids, chromium, and platinum (Reference K275, K278). A white crystalline crust forms on the outside of the filter cake material as it dries.

This material is classified as a "recyclable material" (Reference UE006).

5.21.3 Regulatory Status of Unit

The filter cake by-product containing recoverable quantities of platinum is managed as a "recyclable material" under 40 CFR Part 266, Subpart F.

5.21.4 Waste Constituent Migration Pathways

The potential migration pathways are the air, surface (concrete and asphalt), and surface water. The migration pathway appears to be spillage to the concrete or asphalt surface outside the unit but within the bermed process area. Leakage through the seams and cracks in the concrete pad or asphalt area and berm may migrate to the subsurface soil.

5.21.5 Evidence of Releases and Potential Environmental Impacts

A 1 foot by 2 foot area of fluid was observed resulting from seepage from the SWMU containment area to the process area. This leakage originated from a weeping seam in the concrete berm. This release was contained within the bermed process area where it would be recycled via the process area sump.

Several areas were also observed within the concrete containment area where small quantities of filter cake had dropped to the concrete floor. This material would be recycled back to the process by washdown activities.

Documentation of historic releases from this SWMU was not found during this study.

5.21.6 Analysis of Release Prevention or Mitigation Measures

The release prevention methods employed at this SWMU include the containerization of by-product material into drums at the point of generation or use of a hopper for transport to SWMU KMCC-007 for drying. The raised pad and berms also serve as part of the containment system for this SWMU. Mitigation of leaks through cracks and seams in the concrete containment structure appear to have been undertaken by caulking and/or sealing these features. Additional housekeeping activities will be needed because some of the seam seals were in need of repair as evidenced by the one weeping seam.

5.22 Former Manganese Tailings Areas

5.22.1 Unit/Area Design and Operational History

SWMU KMCC-022 comprises the former tailings areas previously used in conjunction with the manganese dioxide beneficiation process. Based on review of several years of aerial photography, solid materials were placed in these areas sometime between 1950 and 1979 (Reference K164). These areas are located near the east central portion of the fenced and guarded KMCC facility. This SWMU is comprised of two areas: (1) the western portion is immediately west of the current manganese tailings pile (SWMU KMCC-009) and directly north of the Chemstar operation; and (2) the eastern portion is approximately 300 feet south of KMCC-009, north of Unit 6, and on the west side of Eleventh Street (Reference Map 22; SR, August 20, 1991).

Some of the manganese dioxide tailings material placed within the "western" area of SWMU-022 appears to have been removed to facilitate construction of Surface Impoundments P-1 and S-1 in 1972 and 1974. Additionally, manganese tailings were removed from the southern portion of the "western" area and relocated to KMCC-009 in approximately 1989 (Reference K357; SR, August 20, 1991).

The "eastern" area history is obscure. Use of this area is indicated in a few documents (K059, K065, K158A), but cannot be clearly demarcated on the aerial photography (Reference K164). Manganese ore has also been stored in this general area.

An SR of the "western" area was conducted on August 19, 1991. At that time, the "western" area was clear of litter, equipment, and other materials. Tailing piles or mounds were not visibly present in this area. Evidence of their former presence was indicated by dark colored soils and yellow-brown material resembling tailings which were visible in the side walls of SIs S-1, P-1 and Old P-2. The soils in the west side wall of the P-1 SI and on the floor and west wall of the old P-2 SI were stratified with a yellow-brown material resembling manganese dioxide tailings material.

Due to the variable topography within the "western" portion of SWMU-022, surface water run-on would generally flow into this area and not form run-off.

On September 20, 1991, the "eastern" area of the SWMU was observed clear of debris and appeared well maintained. Concrete foundation mats for three tanks were being constructed in this former tailings area northwest of the intersection of Eleventh Street and Avenue G. One manganese dioxide ore pile was also located within this area.

The presence of prior manganese tailings placement was evidenced by dark stained soil in a recent north facing cut slope adjacent to Eleventh Street. Other evidence of the former storage area has been obscured by subsequent plant activities.

Surface water run-on would flow onto the area from the south and east and run-off would flow toward the north.

5.22.2 Unit/Area Waste Characteristics

The manganese tailings disposed of in this SWMU were from the manganese dioxide beneficiation process. These tailings consist of processed manganese dioxide ore which is acid insoluble. The tailings also contain trace heavy metal sulfides, silica, paraffin cake, and calcium sulfate (Reference K037, K137).

Kleinfelder did not find laboratory analyses indicating the composition of the tailings material during the time of placement in this area. However, KMCC believes the composition was probably similar to current tailings material when dewatered. Analyses of the tailings material disposed of at the current tailings site (SWMU KMCC-009) were conducted using EP toxicity testing procedures in 1979 and 1985 and by TCLP methods in 1990 (Reference Table 5.22.2 below). Analytical results from this testing reveals nonhazardous concentrations of the eight heavy metals evaluated by these tests (Reference K111, K147, K179, K264, K319, UE065).

**TABLE 5.22.2
MANGANESE TAILINGS ANALYSES**

<u>Constituents</u>	<u>Units</u>	<u>1979 EP Toxicity</u>	<u>1985 EP Toxicity</u>	<u>1990 TCLP</u>
Arsenic	mg/L	0.007	<0.5	<0.3
Barium	mg/L	0.021	<0.5	<0.5
Cadmium	mg/L	0.049	<0.1	0.45
Chromium	mg/L	0.002	<0.02	0.14
Silver	mg/L	0.012	<0.1	0.09
Selenium	mg/L	<.001	<0.1	<0.3
Lead	mg/L	0.002	<0.5	<0.3
Mercury	mg/L	<.0001	<0.0002	<0.0002

5.22.3 Regulatory Status of Unit

Kleinfelder did not find documentation regarding any special regulatory status for this area. Manganese tailings disposal at the nearby manganese tailings pile (SWMU KMCC-009) is regulated by the NDEP under a May 15, 1985 authorization (Reference K147, K343).

5.22.4 Waste Constituent Migration Pathways

During the operational life of this SWMU, the constituents of the waste could have migrated by air, surface water, soil, or groundwater. Currently, little waste appears to be present and the pathways appear to be reduced to air and soil.

Migration via the air pathway could occur by airborne transport of dried particulate matter due to wind. Surface water run-on, as a result of precipitation in the "western" area, would likely drain into the former P-1, S-1, and Old P-2 surface impoundment depressions. Water which percolated through the tailings may form leachate and migrate into the underlying soil and groundwater.

The constituents in the tailings slurry solution prior to 1975 were chiefly manganese and sulfate. As the solution percolated, these constituents may have migrated through the soils and possibly to groundwater.

5.22.5 Evidence of Releases and Potential Environmental Impacts

Release prevention and mitigative measures instituted by KMCC occurred after this area stopped receiving manganese tailings material. These measures included removal of much of the manganese tailings material which had been placed here.

Small amounts of manganese tailings remain in the soil as evidenced in the side walls of former SIs P-1, S-1 and Old P-2 (Reference SR, August 20, 1991). The tailings are acid insoluble and analyses by EP toxicity and TCLP testing for KMCC indicate they are nonhazardous (Reference K111, K147, K179, K264, K319, UE065). Documentation of historic releases from this SWMU was not found during this study.

5.22.6 Analysis of Release Prevention or Mitigation Measures

There are no known historic release prevention measures associated with this SWMU during its operational life. Release prevention and mitigative measures instituted by KMCC occurred after this area stopped receiving manganese tailings. These measures included removal of much of the manganese waste which had been placed here.

5.23 Closed Surface Impoundment S-1

5.23.1 Unit/Area Design and Operational History

Pond S-1 (SWMU KMCC-023) was a single-lined wastewater surface impoundment located approximately 60 feet south of the steam plant within the fenced and guarded KMCC facility (Reference Map 23). This SI was constructed in October 1974 using a single liner of 20-mil. PVC on the bottom and 30-mil. CPE on the sides (Reference K003, K013, K105, UE024). The S-1 SI had an approximate surface area of 47,500 square feet and an approximate capacity of 2,000,000 gallons (Reference K105, UE024). This SI was constructed as an evaporation pond and was not equipped to recycle material back to the process (Reference K039, UE024).

SI S-1 was constructed in the same area that had been used previously for deposition of solid materials including manganese dioxide process tailings (Reference Section 5.22 of this report). Based on a review of aerial photography, SWMU KMCC-022 (the former manganese tailings areas) existed from prior to 1960 to post 1969 (Reference K164).

The S-1 SI was originally constructed to manage liquid wastes from the sodium chlorate and sodium perchlorate processes (Reference K003, K013, UE030). Liquid wastes from the potassium chlorate, potassium perchlorate, sodium perchlorate, and boron manufacturing processes were routed to, and stored in, SI S-1 through the fall of 1982 (Reference K039, K095, K105). Cooling tower and reboiler wastes from the boron trichloride process were also discharged to SI S-1 during these same dates (Reference K170). The production of potassium perchlorate was terminated in September 1982 (Reference K105). Chromium containing wastes were not placed in SI S-1 after August 1982 (Reference K130). This SI began decommissioning in the fall of 1982 and was closed in January 1983 [(Reference K105)]. A closure plan and final closure were approved by NDEP on April 16, 1985 and December 5, 1985, respectively (Reference K112, K131).

Decommissioning of SI S-1 was initiated in the fall of 1982 when the production of potassium perchlorate was terminated. The liquids were removed by solar evaporation and pumping to nearby SI P-1. During closure, the solid contents (dewatered solids

containing approximately 10% moisture) and the bottom and side liners were removed with a clamshell and paddle scraper. Approximately two feet of soil underlying the bottom and side liners was also removed during closure operations. These materials (solids, liners, and soil) were disposed in the on-site KMCC hazardous waste landfill (SWMU KMCC-013) prior to January 25, 1983 (Reference K095, K105).

Soil sampling and analyses were conducted following completion of closure work to verify that hazardous constituents (chromium) had been removed. Composite soil samples and discrete soil samples were collected during two separate sampling events from four feet below the base of the closed SI and from three feet below grade in immediately adjacent areas. The soil samples were analyzed by EP Toxicity methods and revealed concentrations of total soluble chromium ranging between < 0.02 and 0.11 milligrams per liter (mg/L). These results were significantly less than the required cleanup level of 5.0 mg/L; therefore, KMCC concluded that the closure of SI S-1 had been completed in compliance with NDEP standards (Reference K105).

The former site of SI S-1 was observed during an August 20, 1991 SR. This area appeared as a graded depression approximately 60 to 180 feet south of the steam plant. The depression was free of trash or debris and appeared well maintained. Four groundwater monitoring wells were observed in the vicinity of the SI; three were downgradient (north) of SI S-1 and a fourth was upgradient (south) of SI P-1 which is south of this SWMU.

A limited amount of surface water run-on could flow into the SI from the areas immediately adjacent to the SI. Rills were apparent in the north and south sidewalls of the excavation indicating some run-on has entered this excavation.

5.23.2 Unit/Area Waste Characteristics

KMCC submitted a Part A application for SI S-1 on November 18, 1980. Subsequently, KMCC decided to become only a generator, and SI S-1 was closed prior to the required date of a Part B application. Liquid wastes from the sodium chlorate (containing chromium) and sodium perchlorate process were originally stored in this SI between late 1974 and late 1975. By January 1976, liquid wastes from the potassium chlorate, potassium perchlorate (containing chromium), sodium perchlorate, and boron manufacturing processes were routed to and stored in SI S-1 (Reference K039, K095, K105).

The liquid wastes contained a total chromium concentration in excess of 5 mg/L by EP toxicity test methods which resulted in this waste being managed as hazardous. The residual solids (which crystallized in the nearby surface impoundment P-1 as a result of solar evaporation) were also analyzed and contained less than 5 mg/L leachable chromium when subjected to EP Toxicity testing (Reference K105).

5.23.3 Regulatory Status of Unit

KMCC submitted a Part A application for SI S-1 on November 18, 1980. Subsequently, KMCC decided to become only a generator, and SI S-1 was closed prior to the required date of a Part B application (Reference K062, K063, K095).

KMCC submitted a closure plan, for clean closure of SI S-1, to the NDEP dated April 5, 1984 (Reference K095). A revised closure plan, dated September 26, 1984, was submitted following incorporation of information requested by the NDEP (Reference K105). Following a public comment period, the revised closure plan was approved by the NDEP in a letter dated April 16, 1985 (Reference K112).

Closure of SI S-1 was conducted under interim status standards of 40 CFR Part 265 (Reference K130, K131, UE131). Following completion of closure activities by KMCC, J. H. Kleinfelder and Associates provided a review of the project activities to evaluate whether closure had been conducted in conformance with the approved closure plan. Based on the information provided by KMCC and field observations, a professional opinion was rendered that SI S-1 was closed in conformance with the intent of the approved closure plan (Reference K123). The NDEP acknowledged proper closure of SI S-1 in a letter dated December 5, 1985 and acknowledged that SI S-1 no longer remained under the interim status standards of 40 CFR Part 265 (Reference K131).

5.23.4 Waste Constituent Migration Pathways

During the operational life of SI S-1, the migration pathway would have been the underlying and adjacent soils and possibly groundwater.

5.23.5 Evidence of Releases and Potential Environmental Impacts

Kleinfelder found documentation referring to a possible liner failure for the S-1 SI in 1980 (Reference K055). Soil contaminated with chromium was removed during closure activities in the fall of 1982 (Reference K123).

The analytical results of soil samples collected to support closure revealed the presence of low concentrations of chromium in soil collected from beneath the SI bottom. These analyses showed leachable chromium concentration ranging between < 0.02 and 0.11 mg/L by EP Toxicity testing methods which was less than the required clean-up level of 5.0 mg/L (Reference K105).

The results of groundwater monitoring from monitoring wells in the vicinity of SI S-1 (conducted between May 1982 and June 1985) revealed the presence of chromium in shallow groundwater (Reference K058, K066, K068, K077, K092, K106, K126A). These results revealed that chromium was also present in groundwater samples collected upgradient of SI's S-1 and P-1 as well as downgradient of these two SI's. An expanded program was undertaken and numerous additional monitoring wells were installed in an effort to locate the source of the chromium contamination. As a result of those efforts, the source was traced to the basements of Units 4 and 5 (Reference K105, K170).

5.23.6 Analysis of Release Prevention or Mitigation Measures

The release prevention methods employed during the operational life of SI S-1 were (Reference K054, K105):

- o use of a single synthetic liner to contain liquid waste;
- o maintenance of a freeboard to reduce the possibility of overtopping; and
- o periodic pond monitoring to evaluate if leakage was occurring.

The S-1 SI was decommissioned in the fall of 1982 and the liner, solids, and adjacent soils were removed prior to January 23, 1983. Analytical results of soil samples collected to demonstrate clean closure revealed concentrations of total soluble chromium were significantly less than the required clean-up level of 5.0 mg/L (Reference K105).

5.24 Closed Surface Impoundment P-1

5.24.1 Unit/Area Design and Operational History

Pond P-1 (SWMU KMCC-024) was a single lined wastewater surface impoundment located approximately 200 feet south of the steam plant (immediately south of SI S-1) within the fenced and guarded KMCC facility (Reference Map 24). This SI was originally constructed in April 1972 using a single PVC liner on the bottom and CPE underliner on the side walls (Reference K003, K105, UE024). This SI was abandoned in July, 1975 (Reference K031) because the original liner failed (Reference K037, UE024). The P-1 SI was relined in 1980 with a 30-mil. hypalon liner (Reference K105). SI P-1 had an approximate surface area of 26,000 square feet and an approximate capacity of 700,000 gallons (Reference K105, UE024). SI P-1 was constructed as an evaporation pond and was not equipped to recycle material back to the process (Reference K031, K039, UE024).

Liquid waste from the potassium chlorate, potassium perchlorate (containing chromium), sodium perchlorate, and boron manufacturing processes were stored in SI P-1 between early 1972 and July 1975 and again between mid 1980 and December 1982 (Reference K031, K037, K039, K095, K105, K130). Cooling tower and reboiler wastes from the boron trichloride process were also discharged to SI P-1 during these same dates (Reference K170). The production of potassium perchlorate was terminated in September, 1982 (Reference K105). Liquors, residual salt solutions, and rinsates generated during the decommissioning and closure of SI S-1 and decommissioning of the potassium perchlorate manufacturing process were transferred to SI P-1 in the fall of 1982 and chromium containing solutions were not placed in SI P-1 after December 1982 (Reference K105, K130, K170). The P-1 SI was subsequently decommissioned prior to January 25, 1983. A closure plan and final closure were approved by NDEP on April 16, 1985 and December 5, 1985, respectively (Reference K112, K131).

Decommissioning of SI P-1 was initiated in the winter of 1982/1983 following the decommissioning of SI S-1 (Reference K105). The liquids were removed by solar evaporation (Reference K124). During closure, the solid contents, the liner, and an unknown quantity of soil from beneath the liner were removed and disposed in an on-site nonhazardous waste landfill (which is believed to be SWMU KMCC-009) between July 25, 1985 and August 8, 1985 (Reference K124, K170).

Soil sampling and analyses were conducted following completion of closure work to evaluate whether hazardous constituents (chromium) were present in the underlying soil. Soil samples were collected at one-foot increments between the surface and 4-1/2 feet below grade at six locations beneath the base of the former SI. The soil samples were analyzed using EP Toxicity testing procedures and concentrations of leachable chromium ranging between < 0.1 and 0.41 milligrams per liter (mg/L) were reported. These results were significantly less than the required cleanup level of 5.0 mg/L (Reference K124).

The former site of the SI was observed during an August 20, 1991 SR. The area appeared as a graded depression between approximately 200 to 280 feet south of the steam plant. The depression was free of trash or debris and appeared well maintained. Four groundwater monitoring wells were observed in the vicinity of the SI; three were downgradient (north) of neighboring SI S-1 and a fourth was upgradient (south) of SI P-1.

Surface water run-on could flow into the SI from the south. Rills were apparent in the east and west sidewalls of the excavation indicating run-on has entered this excavation.

5.24.2 Unit/Area Waste Characteristics

This SI was used to store liquid wastes between April 1972 and July 1975 and then again from 1980 to prior to January 25, 1983 (Reference K031, K037, K095, K105). The liquid wastes originated from the potassium chlorate, potassium perchlorate, sodium perchlorate (containing chromium), and boron manufacturing processes and were similar to wastes stored in SI S-1 (Reference K039, K095, K105). Additionally, liquors, residual salt solutions, and rinsates generated in the fall of 1982 during the decommissioning and closure of SI S-1 and the decommissioning of the potassium perchlorate manufacturing process were transferred to SI P-1 (Reference K105, K170).

The liquid waste contained total chromium concentration in excess of 5 mg/L by EP Toxicity test methods which resulted in this waste being managed as hazardous. The solids (which crystallized in this surface impoundment as a result of solar evaporation) were sampled on October 18, 1983 and analyses by EP Toxicity testing methods showed nonhazardous concentrations of leachable chromium ranging between < 0.2 and 1.3 mg/L and non-detectable concentrations of the remaining seven analyzed metals (Reference K105).

5.24.3 Regulatory Status of Unit

KMCC submitted a closure plan for clean closure of SI P-1 to the NDEP dated April 5, 1984 (Reference K095). A revised closure plan, dated September 26, 1984, was submitted following incorporation of information requested by the NDEP (Reference K105). Following a public comment period, the revised closure plan was approved by the NDEP in a letter dated April 16, 1985 (Reference K112).

Closure of SI P-1 was conducted under interim status standards of 40 CFR Part 265 (Reference K130, K131, UE131). Following completion of closure activities by KMCC, J. H. Kleinfelder and Associates provided a review of the project activities and conducted soil sampling. Based on the information provided by KMCC, field sampling, field observations, and laboratory results, an opinion was rendered that SI P-1 was closed in conformance with the intent of the approved closure plan (Reference K124). The NDEP acknowledged proper closure of SI P-1 in a letter dated December 5, 1985 and acknowledged that SI P-1 no longer remained under the interim status standards of 40 CFR Part 265 (Reference K131).

5.24.4 Waste Constituent Migration Pathways

During the operational life of SI P-1, the migration pathway would have been the underlying and adjacent soils and possibly groundwater.

5.24.5 Evidence of Releases and Potential Environmental Impacts

Kleinfelder found documentation of releases occurring during the operational life of this SI. Reference documents K031, K037, and UE024 indicate SI P-1 was abandoned in July, 1975 and relined in 1980 due to liner leakage. Soil contaminated with chromium was removed during closure activities (Reference K124). The analytical results of soil samples collected to demonstrate proper closure revealed the presence of low concentrations of chromium in soil collected from beneath the SI bottom. These analyses showed leachable chromium concentrations ranging between < 0.1 and 0.41 mg/L by EP Toxicity testing methods. These concentrations are less than the required clean-up level of 5.0 mg/L (Reference K124).

The results of groundwater monitoring from monitoring wells in the vicinity of SI P-1 (conducted between May, 1982 and June, 1985) revealed the presence of chromium in

shallow groundwater (Reference K058, K066, K068, K077, K092, K106, K126A). These results revealed that chromium was present in groundwater samples collected upgradient of SI's S-1 and P-1 as well as downgradient of these two SI's. An expanded program was undertaken and numerous additional monitoring wells were installed in an effort to locate the source of the chromium contamination. As a result of these efforts, the source was traced to the basements of Units 4 and 5 (Reference K105, K170).

5.24.6 Analysis of Release Prevention or Mitigation Measures

The release prevention methods employed during the operational life of SI P-1 were (Reference K054, K124):

- o use of a single synthetic liner to contain liquid waste;
- o maintenance of a freeboard to reduce the possibility of overtopping;
- o periodic pond monitoring to evaluate if leakage was occurring.

The P-1 SI was decommissioned in the winter of 1982/1983. The liner, solids, and adjacent soils were removed during closure. Analytical results of soil samples collected to demonstrate closure revealed concentrations of total chromium were less than the required clean-up level of 5.0 mg/L (Reference K105).

5.25 Truck Emptying/Dump Site

5.25.1 Unit/Area Design and Operational History

SWMU KMCC-025 is an open area where solid wastes/materials were periodically discarded. This area is located within a depression along KMCC's western property boundary approximately 800 to 1300 feet northwest of Unit 1. This area is not within the fenced and guarded KMCC facility and can be accessed by the entrance road which also services Pioneer, BMI, Koch, Saguaro, KMCC AP Plant north entrance, NuBulk Transportation, J.B. Kelly, Inc., and Chemstar. This SWMU is bounded by dirt roadways on the east, south, and west sides and a fence along the north side. A railroad track traverses east/west across this area separating the northern third from the southern third. The overall SWMU is approximately 480 feet long north-south by 320 feet wide east-west (Reference Map 25; K161, K164; SR, August 20, 1991).

This SWMU consists of an open soil surfaced depression which was periodically used between 1969 and 1991. Review of August 2, 1979 aerial photography indicates that solid materials (possibly wastes or debris) are present throughout this area (Reference K164). Additionally, the south third of this area was used sometime after August 1979. Apparently, trucks entered the southern area and deposited remnants of the various substances such as soda ash and lime which they had hauled (Reference K357, 1991).

An SR of the southern third of this SWMU was conducted on August 20, 1991. On that day, the area appeared recently graded and soil berms were in place on the east, west, and south sides of the SWMU to restrict access and limit further dumping in this area. Portions of the soil within the SWMU exhibited white discoloration and several small piles of white colored solid waste/material were observed.

The grading and presence of soil berms serves to prevent surface water run-off and run-on to this SWMU.

5.25.2 Unit/Area Waste Characteristics

The composition of the wastes deposited in the SWMU prior to August 1979, and more recently, are unknown (Reference K357).

5.25.3 Regulatory Status of Unit

Kleinfelder did not find documentation regarding any special regulatory status for this area.

5.25.4 Waste Constituent Migration Pathways

The potential migration pathways are the air, surface soil, subsurface soil, and possibly groundwater.

5.25.5 Evidence of Releases and Potential Environmental Impacts

The light colored soil staining and the white colored soil piles indicates the deposition of solid/material waste within this SWMU. The type and nature of solid material present in this area, as observed on August 2, 1979 aerial photography, is not known. Documentation of historic releases from this SWMU was not found during this study.

5.25.6 Analysis of Release Prevention or Mitigation Measures

The material formerly present in this area, as observed on the August 2, 1979 aerial photography, is no longer present on the surface. The disposition of this material is not known.

The access to this SWMU has been restricted through the placement of soil berming at the direction of KMCC. This action should prevent further placement of wastes within this area.

5.26 Former Satellite Accumulation Point - Unit 3, Maintenance Shop

5.26.1 Unit/Area Design and Operational History

SWMU KMCC-026 is a former satellite accumulation point for hazardous waste located within the fenced and guarded KMCC facility at the southwest corner of Unit 3 (Reference Map 26). This SWMU consists of a parts washer within Unit 3 and the adjacent open storage area where lead/acid storage batteries and waste from the parts washer are temporarily stored. Both the parts washing machinery and the drum containing the sludge from the parts washing operation are positioned on a concrete floored and walled area within the maintenance shop. The batteries and drummed parts washer waste are stored outside of Unit 3 on pallets positioned on a concrete pad. This pad is not equipped with run-on/run-off control berms. An area of soil is present adjacent to a part of the western margin of the storage pad (Reference SR, August 20, 1991).

This area was used from approximately 1989 to 1991 for operation of a solvent based parts washer. The former parts washing method has since been replaced with a caustic detergent based parts washer in 1991 (Reference K357).

Historically (1989-1991), parts were placed in the parts washer, the system was closed, and the parts washer scrubbed the parts using jets of 1,1,1-trichloroethane (TCA). The oil and grease removed from the parts accumulated in the bottom of the parts washer and was periodically withdrawn and placed in a drum stored next to the parts washer. When the drum was full, it was transported to a recycler (Reference K357).

An SR was conducted at this SWMU on August 20, 1991. On that date, the area was clear of debris and well maintained. The parts washer was located along the north wall in the southwest corner of the Unit 3 maintenance shop. The parts washer observed during the SR was a Hotsy® caustic soap washer.

Minor cracking and some staining was observed on the concrete floor in the vicinity of the parts washer as well as outside the building in the vicinity of the storage area. Petroleum hydrocarbon stained soils were also observed adjacent to the west side of the storage area. A single 2-inch diameter drain pipe was observed within the concrete surface between the storage area and the entrance to the shop.

Surface water run-on would not affect the parts washer because it is positioned within a building. Surface water run-off would flow to the west and south toward a storm drain located in Seventh Street. However, it appears that run-off would pond rather than flow into the drain due to an irregular gradient.

5.26.2 Unit/Area Waste Characteristics

The specific waste historically stored at this SWMU was a sludge resulting from parts washing operations and consisted of oil, grease, and 1,1,1-TCA. The 1,1,1-TCA containing sludge was volatile and had a very low solubility in water. This solvent waste was considered hazardous due to the presence of 1,1,1-TCA. The chemical characteristics of 1,1,1-TCA (a chlorinated solvent) are described on the applicable MSDS (Reference K033).

The current waste resulting from the new parts washing operations consists of oil, grease, and caustic detergent and is considered a regulated waste but not hazardous.

5.26.3 Regulatory Status of Unit

Kleinfelder did not find documentation regarding any special regulatory status for this area. KMCC formerly managed this SWMU as an area for satellite accumulation of a hazardous waste when the solvent based parts washer was in use (Reference K357).

5.26.4 Waste Constituent Migration Pathways

The migration pathways include the concrete surface, adjacent soil area, surface water, and air. The migration pathways for the current process are the same. Releases which

remain on the concrete surface can be dispersed by surface water run-off to the adjacent soil and asphalt surfaced areas and storm drain in the area. Flows entering the storm sewer system would drain to the Beta Ditch through NPDES monitoring equipment (Reference K178).

5.26.5 Evidence of Releases and Potential Environmental Impacts

Staining was evident on the concrete floor surrounding the current parts washer, however, correlation between these stains and current or historic operations could not be made. The soil, concrete, and asphalt surfaces outside of the building in the vicinity of the temporary waste storage area were also stained. The connection between staining and waste release in this area could not be made because portions of this area are also used for product storage and maintenance of equipment which may contain gear lubricants, greases or oils. The observed product and waste drums appeared undamaged and in good condition.

Documentation of historic releases from this SWMU was not found during this study.

5.26.6 Analysis of Release Prevention or Mitigation Measures

The release prevention methods employed at this area include containerization of parts washer sludge from the point of generation to the point of disposal (recycling).

This SWMU appears adequate in size for the present operation and should have been adequate for the former operations. Mitigative spill response measures include prompt clean-up of spills when these occur (Reference K357).

5.27 Former Satellite Accumulation Point - Unit 6, Maintenance Shop

5.27.1 Unit/Area Design and Operational History

SWMU KMCC-027 is a former satellite accumulation point for hazardous waste resulting from a former solvent based parts washer in Unit 6. This SWMU is located inside the northeast portion of Unit 6, along the west wall of this maintenance shop, which is within the fenced and guarded KMCC facility. This area consists of a concrete floored and walled maintenance shop, a parts washer (which formerly used 1,1,1-TCA containing solvent), and a drum for temporary storage of parts washer waste (Reference Map 27; SR, February 20, 1992).

This SWMU has been in use since 1989. A closed circulation, solvent based parts washer was used for cleaning oil and grease from valves, fittings, and other items requiring maintenance until late 1991. The oil and grease containing 1,1,1-TCA accumulated in the bottom of this parts washer and was periodically withdrawn and placed in a drum stored next to the parts washer. The historic washer remains in use; however, the 1,1,1-TCA based solvent has been replaced with a nonhazardous, caustic based detergent (Reference K357).

An SR of this SWMU was conducted on February 20, 1992. On that day, the area appeared well maintained. The concrete floor and block wall in the immediate vicinity of the parts washer were intact and cracks were not observed.

5.27.2 Unit/Area Waste Characteristics

The waste historically managed in this area was an oily sludge containing oil, grease, and 1,1,1-TCA resulting from parts washing operations. This waste was considered hazardous due to the presence of 1,1,1-TCA. The chemical characteristics of 1,1,1-TCA (a chlorinated solvent) are described on the applicable MSDS (Reference K033).

The current waste resulting from parts washer operations consists of oil, grease, and a caustic detergent parts washing solution which is considered a regulated waste but not hazardous.

5.27.3 Regulatory Status of Unit

Kleinfelder did not find documentation regarding any special regulatory status for this area. However, KMCC formerly managed this SWMU as an area for satellite accumulation of a hazardous waste when the solvent based parts washer was in use (Reference K357).

5.27.4 Waste Constituent Migration Pathways

The waste historically generated by this parts washer was containerized and stored within the same concrete floored building. The migration pathways included the concrete surface, air, and soil beneath the concrete floor.

5.27.5 Evidence of Releases and Potential Environmental Impacts

Kleinfelder did not find documentation of releases occurring in this area. Visual observation of this area was conducted during a February 20, 1992 SR because this shop was closed and locked on each occasion that previous SRs were attempted. The area surrounding the parts washer appeared well maintained. Leakage/spillage from the parts washer was not apparent.

5.27.6 Analysis of Release Prevention or Mitigation Measures

This parts washer uses a closed circulation system and is equipped with a lid which, when closed, reduced emissions of volatile constituents formerly used. The release prevention methods formerly employed in this area include containerization of parts washer sludge from the point of generation to the point of disposal (recycling). Mitigative measures included prompt clean-up of spills when these occurred (Reference K357).

5.28 Satellite Accumulation Point - AP Laboratory

5.28.1 Unit/Area Design and Operational History

SWMU KMCC-028 is a satellite accumulation point for hazardous wastes resulting from disposal of chemicals used in an on-site analytical laboratory. This SWMU is located outside, along the north wall of the laboratory in the ammonium perchlorate area, within the fenced and guarded KMCC facility (Reference Map 28).

This SWMU consists of three metal chemical storage cabinets used to store partially full containers of flammable liquids. The cabinets were properly identified. These cabinets rest on a raised concrete pad adjacent to the north wall of the laboratory. The concrete pad is approximately three inches high, two feet wide, and 12 feet long. A 55-gallon drum is situated on the asphalt surface adjacent to the cabinets. This asphalt surface surrounds the building and the raised pad. The drum is typically stored next to the northwest corner of the concrete pad to accept full containers of waste (Reference SR; August 20, 1991).

This accumulation point is currently in use. Operating practices at this SWMU consist of episodic accumulation of chemicals used in the lab. As the chemicals are used, they

are accumulated in containers and placed in the flammable liquid storage cabinets. When the containers are full of liquid waste, they are placed into a 55-gallon drum and packed in vermiculite (lab-packs). When this drum is full, it is removed for disposal (Reference K357).

An SR was conducted at this SWMU on August 20, 1991. On that day, the cabinets were observed intact, labeled "Flammable Keep Fire Away", and closed. One of the three cabinets was locked. Labels were observed on the glass bottles and metal cans indicating the chemicals contained within. A 55-gallon drum, for packaging of individual containers, was not present. This drum's standard location was evidenced by a round ring on the asphalt surface near the northwest corner of the cabinets. The area was orderly and well maintained.

Surface water run-on would flow past this area from the west and southwest and flow towards the northeast. The cabinets are positioned under the overhang of the laboratory building roof, therefore, rainfall would not fall directly on this SWMU.

5.28.2 Unit/Area Waste Characteristics

This SWMU receives liquid wastes from the adjacent on-site laboratory. These wastes are comprised chiefly of flammable liquids. The chemical and physical characteristics of the various chemicals are listed on the appropriate MSDS (Reference K033).

The containers containing liquid wastes observed during the SR were labeled with "Chemical Name", i.e. "waste methanol". The wastes observed during the SR included pyridine, toluene, nitrobenzene, methyl isobutyl ketone, and methanol.

5.28.3 Regulatory Status of Unit

Kleinfelder did not find documentation regarding any special regulatory status for this area. However, the waste materials in the drum are regulated as a satellite accumulation of a hazardous waste under 40 CFR Section 262.34.

5.28.4 Waste Constituent Migration Pathways

The migration pathways for chemical releases at this SWMU include the concrete and asphalt surfaces, air, surface water, and possibly the soil. Because the wastes are

contained in small glass or metal containers which are then drummed as a lab pack, the potential for migration into the environment is greatly reduced. The area immediately surrounding the SWMU is asphalt covered, further reducing the potential for migration to the soil.

5.28.5 Evidence of Releases and Potential Environmental Impacts

Indications of releases at this SWMU were not observed during the SR and Kleinfelder did not find documentation of releases occurring in this area. The waste management practices employed and the characteristics of this SWMU result in a reduced potential for release and environmental impact.

5.28.6 Analysis of Release Prevention or Mitigation Measures

This SWMU appeared to have adequate capacity for the liquid wastes present during the SR. The release prevention methods employed at this SWMU include the containerization of the wastes. Initial containment in individual containers intended for the waste product followed by double containment in a vermiculite packed drum (lab-pack) reduces the potential for releases.

5.29 Satellite Accumulation Point - AP Maintenance Shop

5.29.1 Unit/Area Design and Operational History

SWMU KMCC-029 is a satellite accumulation point for hazardous waste resulting from a solvent based parts washer in the AP maintenance shop. This SWMU is located inside the AP maintenance shop, along the south wall, within the fenced and guarded KMCC facility. This area consists of a concrete floored and walled maintenance shop, a solvent based parts washer, and a drum for temporary storage of parts washer waste (Reference Map 29).

This SWMU has been in use since 1989. A closed circulation, solvent based parts washer is used for cleaning oil and grease from valves, fittings, and other items requiring maintenance. The oil and grease containing 1,1,1-TCA accumulates in the bottom of this parts washer and is periodically withdrawn and placed in a drum stored next to the parts washer (Reference K357).

An SR of this SWMU was conducted on August 20, 1991. On that day, the area was clear of miscellaneous objects and well maintained. The parts washer was bright red and easily noticed. The concrete floor and block walls in the vicinity of the parts washer were intact and cracks were not observed. Minor drippage was noted onto the floor beneath the parts washer. On the day of the SR, a parts washer waste drum was not present within the parts washer area. Surface water run-on or run-off is not an apparent factor for this SWMU because it is within the AP maintenance shop building.

A 55-gallon drum containing parts washer waste was noted in the product storage area outside of the AP maintenance building and stored on a plastic pallet next to new 1,1,1-TCA solvent. This product storage area was approximately 150 feet west of SWMU KMCC-029 and within a soil surfaced area.

5.29.2 Unit/Area Waste Characteristics

The waste managed in this area is an oily sludge resulting from parts washing operations and containing oil, grease, and 1,1,1-TCA. This waste is considered hazardous due to the presence of 1,1,1-TCA. The chemical characteristics of 1,1,1-TCA (a chlorinated solvent) are described on the applicable MSDS (Reference K033).

5.29.3 Regulatory Status of Unit

Kleinfelder did not find documentation regarding any special regulatory status for this area. However, the waste material is regulated as a satellite accumulation of a hazardous waste under 40 CFR Section 262.34.

5.29.4 Waste Constituent Migration Pathways

The waste generated by this parts washer is containerized and typically stored within the same concrete floored building. The migration pathways are to the concrete floor and the air.

5.29.5 Evidence of Releases and Potential Environmental Impacts

The SWMU is contained within the concrete floored and walled building. On the day of the SR, a small area of minor drippage from the parts washer was observed on the concrete floor beneath the parts washer.

A small area of minor soil staining was also observed near the base of the drum containing parts washer waste at the product storage area to the west of this SWMU. This stain was approximately two feet in diameter. Correlation between this stain and the parts washer waste could not be made. The product and waste drums observed during the SR appeared undamaged and in good condition.

Documentation of historic releases from this SWMU was not found during this study.

5.29.6 Analysis of Release Prevention or Mitigation Measures

This parts washer uses a closed circulation system and is equipped with a lid which, when closed, reduces emissions of volatile constituents.

The release prevention methods employed in this area include containerization of parts washer sludge from the point of generation to the point of disposal (recycling). Mitigative measures include prompt clean-up of spills when these occur (Reference K357).

5.30 Storm Sewer System

5.30.1 Unit/Area Design and Operational History

The storm sewer system (SWMU KMCC-030) is depicted on Plate 7-1. The storm sewer system comprises a network of concrete and clay tile storm drains (subsurface pipes), manholes (drop inlets), and outfalls (discharge points). This drainage system provided a means to manage both storm water and industrial effluent. The storm sewer system was constructed of several smaller networks. Each network drained discrete portions of the BMI complex and discharged through different outfalls. The outfalls occur along the Beta Ditch, tributaries to the Beta Ditch, and other drainage ditches (Reference K178, UL020). This system was installed during construction of the original BMI complex in 1941 and 1942 (Reference K178, UL001, UL020). The storm sewer system has been used between approximately 1941 and January 1976 to convey storm water and process effluent from throughout the southern portions of the site to the Beta Ditch.

With regard to the KMCC property, run-off from storm events historically would follow the local topography, enter a nearby drop inlet, and follow the storm drain to an

outfall. Effluent from many of the processes was also conveyed through the storm sewer to an outfall. The storm water and effluent exiting the outfall entered the Beta Ditch and were conveyed to the upper and lower BMI ponds. This type of use continued until prior to January 1976 when KMCC attained "zero discharge" industrial wastewater discharge status (Reference K178, K265, K277, K347, UL020).

The storm sewer system also historically conveyed effluent from the U.S. Lime facility (now owned and operated by Chemstar) and also would have received storm water flows from Stauffer, Jones Chemical, and Timet (Reference K265). An April 18, 1980 letter from Flintkote (operating at the facility now owned and operated by Chemstar) to the U.S. EPA indicated that a reclaim tank was installed in 1979 and process related liquids no longer were discharged to the storm sewer (Reference UE072).

The storm sewer system serving KMCC property is currently used for the management of storm water and once through non-contact cooling water. Process wastewaters and fluids are currently conveyed throughout the KMCC facility by a system of surface and subsurface pipelines to on-site lined SIs. As an added margin of safety, many of the storm drains located in, or near, process areas have been sealed or retrofitted with a protective berm to reduce the possibility that wastes, process fluids, or process area contaminated storm water run-off would accidentally enter the storm sewer system (Reference K158A, UE028; SR, August 19, 1991).

5.30.2 Unit/Area Waste Characteristics

Use of the storm sewer system on the KMCC site has changed over time. This system was initially used to convey storm water and process effluent from throughout the southern portion of the site to the Beta Ditch from approximately 1941 through 1976. Between 1945 and January 1976, the effluent included wastes from the chlorate, perchlorate, elemental boron and leach plant processes. Between 1945 and February 1975, the waste included slurried sodium chlorate filter cake containing 0.05% by weight hexavalent chromium (Reference K037, K039, K056, K265, K266).

By January 1976, KMCC had attained "zero discharge" and the storm sewer system was no longer used to convey process effluent or wastewaters. Since January 1976, the storm sewer system has been used by KMCC to routinely convey only storm water and once through non-contact cooling water to the Beta Ditch (Reference K158A, K178, K265, K277, UL020).

The storm sewer system also historically conveyed effluent from the U.S. Lime facility (now owned and operated by Chemstar). An April 18, 1980 letter from Flintkote (operating at the facility now owned and operated by Chemstar) to the U.S. EPA indicated that a reclaim tank was installed in 1979 and process related liquids no longer were discharged to the storm sewer (Reference UE072).

The system historically also received storm water flows from Stauffer, Chemstar, State Industries, Jones Chemical, and Timet (Reference K265).

5.30.3 Regulatory Status of Unit

Discharge from the storm sewer system into the Beta Ditch has been regulated under NDEPS Permit #NV0000078 since the early 1970s (Reference K 158A, K305, K320). Two sampling points are maintained for the system at discharge outfalls to its Beta Ditch. Kleinfelder did not find records of known releases from the storm sewer system other than the designated discharge to the Beta Ditch. Current discharges are reported to the NDEP in monthly discharge reports (Reference K158A).

5.30.4 Waste Constituent Migration Pathways

The potential pathways for migration of waste constituents associated with the storm sewer system are soil, surface water, or groundwater.

Releases to the soil could have occurred if contaminants were present in the waters conveyed by the storm sewer system. They could be discharged to surface water of the Beta Ditch during the infrequent flow events of that ditch. Eventual discharge to Las Vegas Wash is possible.

5.30.5 Evidence of Releases and Potential Environmental Impacts

Prior to 1976, the storm sewer system was a partial contributor to the effluent discharged to the Beta Ditch. As such, a portion of the constituents listed in the report to the EPA by KMCC (see Table 5.20.1) are attributable to the storm sewer system.

Review of the August 2, 1979 aerial photography revealed the presence of a yellow liquid effluent discharging from the western storm sewer outfall into the Beta Ditch and being conveyed to Las Vegas Wash (Reference K164). The source, nature and duration of this effluent discharge is not known.

5.30.6 Analysis of Release Prevention or Migration Measure

The major release prevention measure was the rerouting of process waste streams away from the storm sewer system and into the on-site lined SIs. Storm drains within production areas were sealed and drains in proximity to process areas are bermed to reduce the possibility of wastes, process fluids, or process area contaminated storm water from accidentally entering this system (Reference K158A, UE028, SR, August 12, 1991).

Additionally NDEPS sampling points are located at the two outfalls (001, 002) where the storm sewer system discharges to the Beta Ditch.

5.31 Acid Drain System

5.31.1 Unit/Area Design and Operational History

The acid drain system (SWMU KMCC-031) extends to most parts of KMCC property. The extent of the system is illustrated on Plate 7-2. The system further extends to most manufacturing facilities on the entire BMI complex.

The acid drain system comprises a network of pipes, manholes, and sumps used as a means to collect acid effluent from throughout the BMI complex. The construction included the use of acid-resistant materials (Reference K163, K164). The system had a single outfall at the acid effluent neutralization plant (See Plate 7-2).

The acid effluent was originally neutralized prior to disposal in the "Trade Effluent" disposal ponds using waste caustic liquor from the chlorine plant. This practice was discontinued when the caustic line disintegrated. From that time on, acid waste was apparently discharged directly to the "Trade Effluent" evaporation/settling ponds without neutralization (Reference UL020).

Acid effluent entered the acid drain system from the following areas during the time the BMI complex was operated by the U.S. Government for magnesium production (Reference N009, K163):

- o the chlorine plant;
- o the preparation building;
- o the flux plant and neutralization area; and
- o each of the ten chlorination buildings and associated electrolysis buildings.

The acid drain system was utilized from the time magnesium oxide processing began at the BMI complex (sometime in 1941 or 1942) through the time the plant was closed on November 15, 1944 (Reference UL001). Use of the acid drain system after November 15, 1944 is not well documented.

The acid drain system was apparently used by several companies to discharge various wastes from approximately 1945 through January 1976. A portion of this system carried effluents from the basements of Units 1 through 5 (Reference K265). In this regard, this branch also could have carried effluents from State Industries, a Timet shop, Jones Chemical, a Stauffer office building, and U.S. Lime (operating at the facility is now owned and operated by Chemstar (Reference K265). Another portion of the acid drain system provided drainage from Unit 6 and various portions of Timet property (Reference K265).

A March 16, 1984 letter from KMCC to the NDEP indicates that the KMCC acid drain system was plugged many years ago and that the basement drains in Units 4 and 5 were being sealed with concrete in March 1984 (Reference K092).

5.31.2 Unit/Area Waste Characteristics

The specific wastes conveyed by the acid drain system include the following:

- o caustics (presumed to be sodium hydroxide) (Reference K037);
- o acid process liquors (hydrochloric acid solutions) (Reference UL020);
and
- o dilute magnesium chloride solutions.

Between approximately 1945 and January 1976, the acid drains received flows at least from the following (Reference K265, K277, K298, K300, K301, K302, UE103, UE114):

- o acid spills from within an acid storage tank area;
- o spills and seeps in the basements of Units 4 and 5;
- o potassium chlorate and perchlorate solutions from Unit 4;
- o condensate from various steam traps, water from drinking fountains and washwater from trenches along the north wall of the cell floor in Unit 5;
- o brine rinse and washwater from water softeners;
- o neutralized and unneutralized waste cyanide solution from State Industries; and
- o pickling process wastes from State Industries process line and a surface impoundment which was periodically drained to access liner leaks and allow repairs;
- o effluent from drains in the basement of Units 1 through 5; and
- o chromium bearing solutions from the basement of Unit 6 plus effluent from Time.

5.31.3 Regulatory Status of Unit

Kleinfelder did not find documentation regarding any special regulatory status for this area. The liquid effluent discharges to this area during U.S. Government operations were probably not specifically regulated.

A March 16, 1984 letter from KMCC to the NDEP indicates that the KMCC acid drain system was plugged many years ago and that the basement drains in Units 4 and 5 were being sealed with concrete in March 1984 (Reference K092). Based on this information, the system appears to be sealed in-place.

5.31.4 Waste Constituent Migration Pathways

Three of the migration pathways, soil, surface water or groundwater could have been waste constituent pathways associated with the acid drain.

Releases to the soil could have occurred due to breakage of the liner pipe or from leakage at joints and connections. If releases occurred on an on-going basis, migration to the groundwater is possible.

If contaminants were present in the waters conveyed by the storm sewer system, they could be discharged to surface water of the Beta Ditch during the infrequent flow events of that channel. Eventual discharge to Las Vegas Wash is possible.

A review of July 11, 1950 aerial photography (Reference K164) indicates that the pipe which conveyed waste from the neutralization plant to the "Trade Effluent" evaporation/settling ponds had been removed. Discharges from the acid drain system, after this pipe was disconnected, would have followed surface drainage patterns and entered the Beta Ditch (Reference K161, K164; SR, August 20, 1991).

5.31.5 Evidence of Releases and Potential Environmental Impacts

Documented discharges due to pipeline breakage or leakage from joints or connections of the acid drain system were not found.

The acid drain system discharged first neutralized and later unneutralized acid solutions to the Trade Effluent ponds. Therefore the historic releases to the soil and groundwater attributable to that SWMU (KMCC-014), described in Section 5.14.5, are in part attributed to the acid drain system.

Apparent discharge to the Beta Ditch may have occurred after the pipeline between the Trade Effluent ponds and the neutralization plant was removed and before the acid drain system was sealed. Therefore historic discharges to that SWMU (KMCC-020), described in Section 5.20.5, are in part attributable to the acid drain system.

5.31.6 Analysis of Release Prevention or Mitigation Measures

KMCC has prevented releases both to and by the acid drain system by removing it from service.

A March 16, 1984 letter from KMCC to the NDEP indicates that the KMCC acid drain system was plugged many years ago and that the basement drains in Units 4 and 5 were being sealed with concrete in March 1984 (Reference K092). Based on this information, the system appears to be sealed in-place.

Order@enviroincorp.com, 29-Dec-18, 15

6.0 KNOWN OR SUSPECTED RELEASES OR SPILLS

General

Section 6.0 addresses areas of known spills or releases associated with KMCC and tenant equipment and production related activities. Twenty such areas are discussed in this section. The basis information for identifying these areas was obtained from a review of documents, interviews, and site reconnaissance. Each subsection provides the following information on the equipment or production activity associated with the spill or release:

- o description of the spill or release;
- o a description of the response measures;
- o contaminant migration pathways; and
- o evidence of existing environmental impact.

6.1 PCB Transformers

6.1.1 Description of Spill/Release

Background

The KMCC facility currently has 12 PCB containing transformers (Reference K260). The 1980 annual PCB report indicates that at one time there were 22 PCB containing transformers located at various areas within the KMCC facility (Reference K261).

KMCC records indicate that there has been one reportable quantity release of PCB containing fluids from management of these transformers. The reportable quantity (RQ) for PCBs is one pound. The release occurred in November 1990, and was promptly reported to the appropriate regulatory agencies. Cleanup activities were initiated immediately (Reference K321).

Spill/Release

On November 26, 1990, approximately 1.75 pounds of PCB containing fluid (Inerteen) was released within a concrete area beneath the sub 50 (KMCC Transformer # 52) transformer. This transformer was located within Unit 5 on the ground floor (Reference Map 6-1; Grid D4-19). The release occurred from a ceramic seal which cracked during removal of an associated rectifier. The released fluid dripped through access holes and collected on the concrete floor in the basement of Unit 5 (Reference K260, K321; SR, September 9, 1991).

6.1.2 Analysis of Response Measures

The released fluid was cleaned up with absorbents and the fluid in the transformer was evacuated to a level below the crack in the seal. The PCB containing fluid removed from the transformer and the material from clean-up activities was placed into 55-gallon drums in controlled storage awaiting disposal (Reference K321).

Laboratory analyses of wipe samples of the concrete after the initial clean up was completed revealed that elevated concentrations of PCBs were still present (Reference K346). KMCC subsequently removed the contaminated concrete. The concrete in this area was approximately eight inches thick and presented a relatively impervious barrier to the oil. A small amount of soil beneath the concrete was also removed in August 1991 as preparation for replacing the concrete flooring (Reference K340, K341). The soil removed with the concrete was incidental to the concrete removal. This material was disposed off-site at U.S. Ecology, Beatty, Nevada as indicated by the 1991 annual PCB report.

6.1.3 Contaminant Migration Pathways

The contaminant migration pathway for this spill included the concrete surface. The obviously impacted concrete was removed. Some soil immediately underlying the concrete was also removed (Reference K340, K341).

6.1.4 Evidence of Existing Environmental Impacts

Kleinfelder did not observe environmental impacts related to this release. The area in the basement below the former transformer had been repoured with new concrete prior to a September 9, 1991, SR.

6.2 Unit 1 Tenants - Stains

6.2.1 Description of Spill/Release

Background

Portions of the Unit 1 Area (Reference Map 6-1; Grid D1-6) have been leased to tenants for various business activities. Ebony Construction Company leased the subject Unit 1 Area in 1977 and 1978 and performed construction related support services near the Unit 1 large garage type openings in the north wall (Reference K357). Kleinfelder did not find documentation or evidence of truck washing, vehicle refueling, or waste disposal activities that are sometimes associated with construction related activities (Reference SR, September 9, 1991).

Spills/Releases

Two stained soil areas are present immediately north of Unit 1 and appear to be typical of motor oil or diesel fuel dripping from parked vehicles possibly associated with tenant activities. The stained areas, one approximately 10 feet by 10 feet and a second stain of approximately 2 feet by 10 feet, are located approximately 3 to 5 feet north of the Unit 1 building, near a large access opening in the center of the north wall (Reference; SR, September 9, 1991).

6.2.2 Analysis of Response Measures

Kleinfelder did not find documentation or other evidence of a response action to hydrocarbon spills in this area.

6.2.3 Contaminant Migration Pathways

Petroleum hydrocarbons are present in the surface soils. The primary migration pathways are by surface runoff or infiltration into subsurface soils and groundwater.

6.2.4 Evidence of Existing Environmental Impacts

The observed environmental impact is stained surface soil typical of drippage from crankcase or fuel leakage of parked vehicles.

6.3 Unit 2 Salt Redler

6.3.1 Description of Spill/Release

Background

A rubber belt conveyor (Redler brand conveyor) is used to load salt (NaCl) into rail cars at a rail siding adjacent to the southwest corner of Unit 2 (Reference Map 6-1; Grid D4-11). Transfer of salt from storage in Unit 2 to the conveyor feed hopper is accomplished by front end loader. The conveyor has been in operation since January 1990 (Reference K357).

Spill/Release

During loading operations, some salt spills to the ground as a result of routine loader and conveyor operations. Following loading, spilled salt is swept up and returned to storage in Unit 2 (Reference K357).

6.3.2 Analysis of Response Measures

Kleinfelder did not observe indications of significant spills or releases at the time of a September 9, 1991 site reconnaissance. This observation supports the effectiveness of management practices to sweep the area to reduce the chance for environmental impacts.

6.3.3 Contaminant Migration Pathways

The contaminant migration pathways include air, surface water, soil, and groundwater. High winds and gusts of winds during loading operations could provide a pathway for dispersal to other areas. Rainwater could dissolve the salt and transport the solution to subsurface soils and nearby storm sewers. The storm sewers discharge to the Beta Ditch through the KMCC NPDES monitoring stations (Reference K158A, K178).

6.3.4 Evidence of Existing Environmental Impacts

Kleinfelder did not find documentation or other evidence of environmental impacts related to salt spillage from the Unit 2 Salt Redler operation.

6.4 Unit 4 and Unit 5 Basements - Consent Agreement

6.4.1 Description of Spill/Release

Background

Sodium chlorate was produced in electrolytic cells located in Units 4 and 5 from 1945 to November 1989. The location is shown on Map 6-1 (Grid D2, D3-16, 17, 20). Additionally, the eastern portion of Unit 5 has been used to produce sodium perchlorate from 1945 to present. The sodium chlorate and sodium perchlorate electrolytic processes utilize sodium dichromate (hexavalent chromium) in the process solutions (Reference CA017).

On September 9, 1986, KMCC and the NDEP entered into a consent agreement for remediation of groundwater contaminated with hexavalent chromium (Reference K304). A 1985 hydrogeological report prepared by KMCC indicated that the chromium contamination in groundwater beneath the KMCC site originated from leakage of process solutions from the basements of Units 4 and 5 (Reference K167).

Spill/Release

The concrete basements of Units 4 and 5 were used for many years as sumps to collect sodium chlorate and sodium perchlorate process liquor, spillage, and washwater. Deterioration and cracking of the concrete floors resulted in release of some of these liquids to underlying soils and groundwater (Reference K091).

6.4.2 Analysis of Response Measures

Operation of the former sodium chlorate electrolytic cells in Units 4 and 5 has been discontinued. Sodium perchlorate continues to be produced in the eastern portion of Unit 5.

Remedial activities have included concrete sealing, repair of the basement floors (conducted in 1983 and 1984), and strengthening of operational procedures in 1986 to further reduce and control spillage (Reference K091, K092, K105, K146A, ND049).

The basement areas were not managed as disposal areas, and therefore sludge did not accumulate in these areas. During decommissioning of the plant minor amounts of floor rubble (concrete) were removed and disposed off-site at U.S. Ecology's Beatty, Nevada facility.

The groundwater contaminant plume geometry has been evaluated and a groundwater interception, treatment, and reinjection system has been installed (Reference K167, K304). The remediation program is the subject of continued monitoring and reporting to the NDEP (Reference K304).

6.4.3 Contaminant Migration Pathways

The contaminant migration pathway is to soils and shallow groundwater beneath Units 4 and 5 (Reference K091, K167). The resultant plume is migrating in a north-northwesterly direction in the shallow groundwater (Reference K167).

6.4.4 Evidence of Existing Environmental Impacts

The hexavalent chromium plume extends greater than 4,000 feet downgradient (to the north) of Units 4 and 5 (Reference K167). A network of sampling and interception wells was installed to monitor and intercept the plume for treatment. The intercepted groundwater is pumped, treated to remove chromium, and then reinjected downgradient of the intercept line (Reference K304; Section 5.19 of this report). The effectiveness of the groundwater remediation program is periodically reported to the NDEP in accordance with the September 9, 1986 consent agreement.

6.5 Unit 6 Basements - Remediation Project

6.5.1 Description of Spill/Release

Background

High purity, battery active manganese dioxide has been produced in electrolytic cells in Unit 6 from 1951 to present (Reference Map 6-1; Grid D2, D3-22, 23). The basement

of Unit 6 had been used to collect process spillage and washwater from the manganese dioxide operations (Reference K249). Based on a hydrogeological report prepared by KMCC in 1985, KMCC and the NDEP entered into a Consent Order on September 16, 1986 to address environmental impacts attributed to the spillage and release of process solutions to the ground. This Consent Order related to initiation of remediation activities required to mitigate the source of a plume of high conductivity groundwater originating from Unit 6 (Reference K146C).

Spill/Release

During operation, the electrolytic cells occasionally overflowed resulting in spillage of manganese sulfate solution to the basement area. As the floor deteriorated and fractured, spilled solutions percolated into the underlying soils and groundwater. The manganese sulfate solutions percolating through the soils are responsible for soil swelling and concrete heaving in the basement slabs and footings. Groundwater contamination in the area is described as a plume of high conductivity groundwater and the source has been traced to the basement of Unit 6 (Reference K146A, K146C, K249).

6.5.2 Analysis of Response Measures

The basement area was not managed as a disposal area, and therefore, sludge did not accumulate in this area. KMCC initiated and maintains several remediation measures which were started in 1986 to address existing contamination and to eliminate further contamination of the groundwater from sources within Unit 6. The basement was cleaned, the concrete floor removed, and the soil recontoured. The removed debris was disposed in the manganese dioxide tailings area. The basement area was then lined with a 100 mil. high density polyethylene (HDPE) liner across floor areas and 8 to 10 inches up the walls and foundations. The liner system installation was completed in December 1987 (Reference K249; SR, September 9, 1991).

Ongoing operational measures include routine visual checks of the basement area for standing solutions or leaks. When found, liquids are pumped back to solution storage. Additionally, periodic leveling checks and adjustments of the electrolytic cells

(weekly) and anolyte headers (quarterly) are made to reduce the potential for spills due to elevation and leveling problems (Reference K146A, K146C).

The integrity of the basement liner system is periodically checked and serviced. The results of the liner servicing are reported to the NDEP in Annual Discharge Monitoring reports (DMRs) such as the December 1989 DMR (Reference K320).

6.5.3 Contaminant Migration Pathways

The contaminant migration pathway is to soils and shallow groundwater beneath Unit 6 (Reference K146A, K146C, K167). The resultant plume is migrating in a north-northwesterly direction in the shallow groundwater and co-mingles with the chromium plume associated with Units 4 and 5 (Reference K167).

6.5.4 Evidence of Existing Environmental Impacts

Existing impacts include manganese sulfate contaminated soil and high TDS groundwater (Reference K146C). The groundwater impact is evidenced by a plume of high conductivity which originates beneath Unit 6 (Reference K167).

6.6 Diesel Storage Tank Area - Stains

6.6.1 Description of Spill/Release

Background

The diesel fuel storage tank area has been in use since the early 1940s (Reference N009, N011). The area includes a 500,000 gallon storage tank and an estimated 18,000 gallon overflow tank. Each above ground storage tank (AGST) rests within its own bermed area. These AGSTs are located north of the Chemstar facility (Reference Map 6-1, Grid C4-14 and SR, September 9, 1991).

Spill/Release

Kleinfelder did not find records of spills in this area. However, soil staining was observed around approximately 30 percent of the base area of the storage tank and the

presence of characteristic diesel fuel odor was noted during a September 9, 1991 SR. Soil staining was not noticeable near the overflow tank which is located immediately northwest of the main storage tank (Reference SR, September 9, 1991).

6.6.2 Analysis of Response Measures

Moats are present near the base of the tanks and consist of channels approximately eight inches wide and one to four inches deep with a slope to a low point where drain valves are located. Signs of recent tank leakage (fuel oil) were not present in the moats. Response measures appear to be adequate with the exception that stained soils near the base of the storage tank have not been removed (Reference SR, September 9, 1991).

A Spill Prevention, Control, and Countermeasures (SPCC) Plan is in place for this tank facility (Reference K357).

6.6.3 Contaminant Migration Pathways

The contaminant migration pathway is to soil and potentially to groundwater.

6.6.4 Evidence of Existing Environmental Impacts

The presence of soil staining and diesel odor indicates that there has been some localized environmental impact (Reference SR, September 9, 1991).

6.7 Former Old Main Cooling Tower and Recirculation Lines

6.7.1 Description of Spill/Release

Background

The old main cooling tower was approximately 50 feet high and 700 feet long, constructed of redwood, and located north of the manganese dioxide process Leach Plant (Reference Map 6-1, Grid C2-18 to 23). This tower was operated from 1941 until September 1989. The cooling tower was demolished in October 1989 (Reference K339, N009, N011).

During its operation, the tower served the needs of the BMI complex and in later years served the cooling needs of KMCC and Timet. Timet discontinued use of this cooling source in approximately July/August 1986 following installation of their own cooling system (Reference K146A).

Spill/Release

Prior to 1989, the old main cooling tower experienced several recirculation water upsets which resulted in discharge of high conductivity water to the Beta Ditch. These discharges were routinely reported to the NDEP in accordance with KMCC's NPDES permit. During the period of September 20, 1984, through February 11, 1986, KMCC reported 23 such discharges from the cooling tower to the Beta Ditch (Reference ND048).

The causes of the recirculating water discharges typically included:

- o power failure due to a storm event (Reference K034, K146A);
- o increase in the volume of water returned to the cooling tower from unknown sources (Reference K326, K330);
- o the addition of stabilized water in the cooling water return from Timet due to sources including emergency cooling water for Timet's scrap furnace (Reference K327, K329, K332, K333); and
- o increase in the volume of water in the cooling tower from unknown sources. Contributing factors may have included: (1) a reduced heat load due to a cutback in sodium chlorate production; and (2) cooler weather (Reference K331).

Individual discharges varied in length from a few hours to several days. The estimated amount of discharged water was reported to the NDEP along with the analytical results for pH, conductivity, sodium chloride, zinc, and phosphate (Reference K326, K327, K328, K329, K330, K331).

Prior to January 1976, the flow path was through the Beta Ditch and on to the BMI ponds. Between January 1976 and June 1985, the flow path was to the Las Vegas Wash via the Beta and Alpha Ditches or was routed to the BMI ponds. In June 1985,

the Pittman area bypass pipeline was completed and subsequent non-industrial process discharges went through the Beta Ditch and the Pittman bypass pipeline to the Las Vegas Wash (Reference K034, K158A, UB001, UB018).

KMCC records also indicate one other discharge related to the old main cooling tower. On May 10, 1980, sodium chlorate process solution entered the recirculating water system as a result of a sudden gasket failure on an associated heat exchanger. Due to safety concerns associated with chlorate potentially impregnating the wood, approximately 500,000 to 600,000 gallons were purged from the tower. The purged water, containing approximately 50 to 75 tons of chlorates and dissolved solids (including between 1,000 to 1,300 pounds of sodium dichromate), was routed to the upper BMI ponds via the Beta Ditch. This discharge was reported to the NDEP (Reference K038).

6.7.2 Analysis of Response Measures

Response measures conducted by KMCC during cooling tower recirculation water upsets included (Reference K326, K327, K328, K329, K330, K331):

- o assessment of the cause of the upset;
- o mitigation of the cause when identified; and
- o reporting the discharge to the NDEP.

Additionally, discharges were often routed to the upper BMI ponds to avert discharge directly to the Las Vegas Wash (Reference K034, K038).

Other response measures conducted by KMCC between 1985 and 1989 included (Reference K146A):

- o installation of alarms to warn staff of power loss to the recirculation pump and high level indicators for recirculating water; and
- o initiation of an inspection/notification/sampling procedure wherein staff routinely inspected routinely inspected and monitored the cool

The companies sharing this cooling tower constructed separate towers for their specific needs. The old cooling tower was removed from service in September 1989, demolished, and sent to off-site disposal (Reference K339, K357). Some foundations remain in place and can be observed in the vicinity of the manganese tailings pile north of the Manganese Leach Plant (Reference SR, September 9, 1991).

6.7.3 Contaminant Migration Pathways

Discharges were through surface drainages (The Beta Ditch and Alpha Ditch). Some infiltration may have occurred to soils within the drainage. Contaminants would consist of dissolved salts contained in the tower feed water (stabilized water from Lake Mead), which were concentrated as evaporation occurred during cooling.

6.7.4 Evidence of Existing Environmental Impacts

The environmental impacts of historic main cooling tower discharges are related to infiltration of recirculated cooling water along the surface drainages and discharge to either the upper BMI ponds or the Las Vegas Wash.

6.8 Leach Plant Area Manganese Ore Piles

6.8.1 Description of Spill/Release

Background

Manganese ore has been stored and processed on-site since WECCO initiated electrolytic manganese dioxide production in 1951. Manganese ore has historically been stored in piles located in a rectangular shaped area near the Leach Plant (Reference Map 6-1, grid coordinates C9-20 to C6-20 to C6-23 to C9-23). The two manganese ore storage piles observed during the SR were long and narrow; measuring approximately 10 to 15 feet high and over 300 feet long. The ore was stored on the ground and was black in color. The manganese ore typically ranged in size from approximately 1/2 to 1 inch in diameter (gravel size). The larger size ore was used to significantly reduce the chance for generation and dispersal of fines (Reference SR, September 10, 1991).

The manganese ore routinely assays greater than approximately 55 percent (by weight) manganese dioxide (MnO_2) and is the starting raw material in the beneficiation process ending with the electrolytic production of high purity, battery active manganese dioxide (Reference K165).

Spills/Releases

Manganese ore has been scattered on the ground throughout the Leach Plant area as a result of 40 years of operational activities. The scattering of manganese ore is primarily the result of spillage during loading activities, spillage during transport from one operational area to another, and some dispersal of fines by the wind (Reference SR, September 10, 1991).

Precipitation from infrequent rains can contact the ore piles and scattered ore. The manganese in the unprocessed ore and tailings is not readily soluble in water, therefore the likelihood of rainwater leaching significant quantities of manganese from this material is remote (Reference K037).

6.8.2 Analysis of Response Measures

As noted above, KMCC reduces the potential for wind-blown releases of manganese ore by importing specific size ore; e.g., gravel size. The manganese ore size currently imported is large enough so as not to be easily wind-blown or readily form a dust.

6.8.3 Contaminant Migration Pathways

The primary pathway is to surface soil in the Leach Plant area and to a lesser degree, the air and surface water run-off.

6.8.4 Evidence of Existing Environmental Impacts

Manganese ore has been stored and beneficiated in this area since 1951. Manganese ore was observed throughout the Leach Plant area during a September 10, 1991, SR. Manganese ore is a naturally occurring material and is nonhazardous in nature; i.e. the manganese and some other trace compounds are not readily soluble in water (Reference K111). Table 6.8.1 lists an analysis of the manganese ore, including these trace compounds (Reference K165).

Table 6.8.1.
Analysis of Manganese Dioxide Ore

	Dried at 105°C		
Manganese Dioxide (MnO ₂)	75.65 %	Total Manganese (Mn)	50.73 %
Manganese Mono-oxide (MnO)	3.77 %		
Ferric Oxide (Fe ₂ O ₃)	4.73 %	Iron (Fe)	3.31 %
Silica (SiO ₂)	2.63 %		
Alumina (Al ₂ O ₃)	6.14 %		
Phosphorus Pentoxide (P ₂ O ₅)	0.257 %	Phosphorus (P)	0.112 %
Lime (CaO)	0.09 %		
Magnesia (MgO)	0.07 %		
Sodium Oxide (Na ₂ O)	0.03 %		
Potassium Oxide (K ₂ O)	0.86 %		
Barium Oxide (BaO)	0.24 %		
Titania (TiO ₂)	0.24 %	Titanium (Ti)	0.144 %
Vanadium Pentoxide (V ₂ O ₅)	0.020 %	Vanadium (V)	0.011 %
Cupric Oxide (CuO)	0.068 %	Copper (Cu)	0.054 %
Lead Mono-oxide (PbO)	0.004 %	Lead (Pb)	0.004 %
Zinc Oxide (ZnO)	0.079 %	Zinc (Zn)	0.063 %
Cobaltic Oxide (Co ₃ O ₄)	0.136 %	Cobalt (Co)	0.100 %
Nickel Mono-oxide (NiO)	0.065 %	Nickel (Ni)	0.051 %
Molybdenum Trioxide (MoO ₃)	0.005 %	Molybdenum (Mo)	0.003 %
Chromium Sesquioxide (Cr ₂ O ₃)	0.010 %	Chromium (Cr)	0.007 %
Arsenic Trioxide (As ₂ O ₃)	0.009 %	Arsenic (As)	0.007 %
Tungsten Trioxide (WO ₃)	LT 0.002 %		
Tin Dioxide (SnO ₂)	LT 0.002 %		
Combined Water (H ₂ O)	4.98 %		
Carbon Dioxide (CO ₂)	0.06 %		
Sulphur Trioxide (SO ₃)	0.055 %	Sulphur (S)	0.022 %

Note: Sample weighed at 105°C; moisture content = 8.56 % (as calculated from cargo results).

LT - Not Detected, less than concentration indicated.

Reference K165.

6.9 Leach Plant Area Anolyte Tanks

6.9.1 Description of Spill/Release

Background

The manganese ore is beneficiated in a series of steps including calcining to produce manganese oxide, milling the calcine, and leaching to produce a concentrated manganese sulfate solution. The concentrated manganese sulfate solution produced at the Leach Plant is pumped to the electrolytic cells in Unit 6 where electrolytic manganese dioxide is plated out of solution. Following electrolysis, the manganese sulfate/sulfuric acid solution (termed the anolyte solution) is then gravity drained, with auxiliary pump support, to one of two anolyte storage tanks. The anolyte solution is recycled and reconcentrated in Leach Plant related operations (Reference K253).

There are two anolyte solution storage tanks constructed of rubber-lined or fiberglass-lined carbon steel. Both tanks rest directly on the ground. The temperature of the anolyte solution in the tanks is slightly above ambient and the pressure is atmospheric due to the open top design of the tank (Reference K168, ND009; SR, September 10, 1991).

The anolyte tanks are believed to have been installed by WECCO between 1950 to 1953 during construction of the pilot plant or production plant. The two anolyte tanks are located at grid coordinates C7-19 and C6-19, respectively, on Map 6-1 (Reference SR, September 10, 1991). These tanks are currently in the process of being replaced with new tanks (Reference SR, February 20, 1992).

Spills/Releases

The anolyte tanks have been the source of several releases throughout the life of their use (Reference ND009). The anolyte solution contains sulfuric acid causing the solution to be classified as a hazardous substance (Reference K070). Due to the anolyte solution's corrosive nature, holes have developed in the tank's sides, bottom walls, and rubber lining, leading to leaks.

A review of the KMCC files has revealed instances in which both reportable and non-reportable quantity releases have occurred from the anolyte tanks. The RQ for sulfuric acid is 1,000 pounds (Reference K173).

The following are documented releases on file:

- o January 16, 1983; approximately 125,000 gallons of anolyte solution was released over a 24-hour period (Reference K070A, K170);
- o July 6, 1985; anolyte solution containing 100 gallons of sulfuric acid was released (Reference K168, K170);
- o April 27, 1989; a 1/2-inch hole developed in anolyte tank releasing less than 864 pounds of sulfuric acid (Reference K172); and
- o September 5, 1989; approximately 5,000 gallons of anolyte solution containing approximately 204 pounds of sulfuric acid was released (Reference K173).

6.9.2 Analysis of Response Measures

KMCC's release response actions routinely included one or more of the following (Reference K70A, K173):

- o diking using manganese tailings to contain the spill. The tailings act as both an absorbent and a neutralizing agent because they have a pH of approximately 8-9. The tailings dikes were then returned to the on-site tailings pile;
- o neutralizing with lime/soda ash. The lime or soda ash is added directly to the spilled liquid;
- o pumping the solution to another anolyte storage tank;
- o diverting the flow of anolyte solution from the Unit 6 cells;
- o increasing the flow of anolyte from the leaking tank to the Leach Plant area. This action, in combination with the previous action (flow diversion), serves to reduce the amount of liquid in the tank;
- o notifying appropriate regulatory agencies of the release and mitigative actions taken; and
- o repairing the tank or system that leaked.

A review of the KMCC file documents revealed that prior to 1985, neutralizing agents were not applied to the released solution. The area was diked and the alkaline nature of the soil was depended upon for neutralization (Reference K170A). In later years,

neutralizing agents (such as lime or soda ash) were added to spills in this area (Reference K104, K140A). The addition of neutralizers as a response measure for the more recent spills/leaks appears to be appropriate for the initial mitigation.

As part of a long term response, KMCC is in the process of replacing the existing anolyte tanks with new tanks (Reference SR, February 20, 1992).

6.9.3 Contaminant Migration Pathways

Anolyte solutions (containing sulfuric acid) leaking from anolyte tanks have impacted the surrounding soils. Because early spills and leaks of anolyte solution were addressed through natural neutralization by the soils (caliche), there is potential for groundwater to be impacted by anolyte solution constituents (Reference K170, ND009; SR, September 10, 1991).

6.9.4 Evidence of Existing Environmental Impacts

The soils surrounding the anolyte tanks are visibly stained (Reference SR, September 19, 1991).

A review of the geohydrological report prepared by KMCC in 1985 reveals that shallow groundwater in the the Leach Plant area exhibited elevated conductivity values. A high conductivity plume present in the shallow groundwater extends to the north-northwest from beneath Unit 6 and passes beneath a portion of this area (Reference K167). Therefore, the elevated conductivity values have not been specifically linked to spills or releases in the Leach Plant area.

6.10 Leach Plant Area Sulfuric Acid Storage Tank

6.10.1 Description of Spill/Release

Background

Concentrated sulfuric acid (98 percent by weight) is stored in a vertical, closed top above ground tank installed on a cement containment pad. This tank is believed to have been installed by WECCO between 1950 and 1953 during construction of the original Leach Plant. The sulfuric acid from this tank is fed to the leach tanks to reconstitute the leach solution. The sulfuric acid storage tank is located at grid coordinates C6-20 on Map 6-1 (Reference K253; SR, September 10, 1991).

Spills/Releases

The sulfuric acid storage tank has been associated with both reportable quantity and non-reportable quantity spills. Sulfuric acid is a corrosive hazardous substance with an RQ of 1,000 pounds (Reference K070A, K173). Sulfuric acid releases were onto the concrete containment area with overflow to the surrounding soil. The concrete containment area shows signs of deterioration from the acid spills (Reference SR, September 10, 1991).

A review of KMCC files revealed one documented reportable quantity spill of concentrated sulfuric acid. On July 31, 1984, 200-300 gallons of sulfuric acid was spilled onto the ground south of the Leach Plant (Reference K104A).

6.10.2 Analysis of Response Measures

Upon discovery of the spill on July 31, 1984, KMCC personnel neutralized the acid with lime or soda ash. The National Response Center and the NDEP were both contacted later on the same day to report the spill and actions taken. The NDEP advised KMCC to evaluate the soil pH for nonhazardous indications prior to removing and discarding the impacted soil in the on-site nonhazardous manganese tailings area. The reviewed documentation did not contain a reference as to whether the soil was tested for pH prior to transfer (Reference K104A).

KMCC has replaced the original tank with a new sulfuric acid storage tank that includes secondary containment. The old tank has been shut down and taken out of service. KMCC plans on testing the soil beneath the concrete pad when the old tank is removed (Reference K357; SR, February 20, 1992).

6.10.3 Contaminant Migration Pathways

The contaminant migration pathways are to adjacent soils, the concrete containment pad, and possibly groundwater.

6.10.4 Evidence of Existing Environmental Impacts

The concrete pad beneath the original acid storage tank and the soil in the surrounding area are visibly stained, presumably reflecting residual impacts from historic spills. The concrete pad beneath the former sulfuric acid storage tank shows signs of deterioration.

6.11 Leach Plant Area Leach Tanks

6.11.1 Description of Spill/Release

Background

The leach tanks are an integral part of the manganese ore beneficiation process. Manganese is leached from calcined ore in the presence of fresh sulfuric acid and anolyte solution. The leach tanks accept fresh calcine, sulfuric acid from the sulfuric acid storage tank, and anolyte solution from the anolyte tank. The mixture is then agitated to promote the leaching process (Reference K253; SR, September 10, 1991).

The Leach Plant area contains two sets of leach tanks. Each set consists of open top tanks installed within a concrete containment area. The first set consists of four 2,000- to 3,000-gallon capacity, 5-foot high, tanks which were installed with the original Leach Plant (Reference Map 6-1, grid coordinate C6-20). These tanks were taken out of service on August 1, 1991. The spills addressed in this report are associated with this first set of tanks (Reference SR, September 10, 1991).

The second set of leach tanks was placed on-line, in full operating capacity on August 1, 1991 (Reference K357). This second, new set of tanks is rated at 250,000 gallon capacity and is located within secondary containment. Indications of spills or releases associated with this second, new set of leaching tanks were not observed (Reference SR, September 10, 1991).

Spills/Releases

The first set of leaching tanks (the formerly used tanks) experienced spills as a result of overflow of liquid.

The concrete containment area (concrete pad and curbing) associated with these leach tanks was deteriorated and observed to be in poor condition on September 10, 1991. On the day of the SR, the concrete containment area around the old set of tanks was obviously unable to function as originally designed for retaining liquids. The concrete containment area and the surrounding soil within a 3- to 5-foot radius of each of the four tanks were observed to be visibly impacted from historic spills (Reference SR, September 10, 1991).

6.11.2 Analysis of Response Measures

The spilled leach solution was left on the concrete pad and/or on the ground after the releases occurred. The released solution was considered to be nonhazardous due to the leaching process operating between a pH of 3 to 7. Control of pH between this range assured maximum acid utilization while still producing a concentrated manganese solution suitable as electrolysis feed (Reference K357).

The long term KMCC response was to discontinue use of the first, old set of tanks and replace them with a second, new set of tanks. KMCC installed the second set of leach tanks with improved secondary containment and overflow protection. Overflow protection measures include a higher freeboard on the sides of tanks, overflow lines, and liquid level controls. The new leach tanks were installed on a concrete pad which incorporated secondary containment (Reference SR, September 10, 1991).

The installation of a new set of tanks and associated protection measures appears adequate for mitigating future releases.

6.11.3 Contaminant Migration Pathways

The contaminant migration pathways include the concrete containment pad, the soil beneath and in the immediate vicinity of the pad, and possibly groundwater.

6.11.4 Evidence of Existing Environmental Impacts

The concrete containment pad and the surrounding soil within a three to five foot radius of each of four tanks are visibly stained from historic spills of leach solution (Reference SR, September 10, 1991).

A review of the 1985 hydrogeological report prepared by KMCC reveals that shallow groundwater beneath the Leach Plant area exhibited elevated conductivity values (Reference K167; Section 6.9.4 of this report).

6.12 Leach Plant Area Transfer Lines To/From Unit 6

6.12.1 Description of Spill/Release

Background

The Leach Plant produces a concentrated manganese sulfate solution that is pumped to the Unit 6 electrolytic cells (Reference Section 6.9.1 of this report). In the electrolytic cells, manganese dioxide is plated out and the electrolyte (anolyte solution composed of sulfuric acid and manganese sulfate) is returned to the leach plant for reconstitution. Currently, there are two above ground solution transfer pipelines between Unit 6 and the Leach Plant area sharing a common pipe rack, pipe trench, and pipe supports. These lines carry the spent anolyte solution and the concentrated manganese sulfate solution between Unit 6 and the leach plant. These lines are located at the following grid coordinates: D-21 to C9-21 to C9-19 to C7-19 as shown on Map 6-1. The original Leach Plant had underground transfer lines which experienced numerous small leaks. The underground transfer lines were replaced with above ground lines in 1986 (Reference K146A, K146C; SR, September 10, 1991).

Historically, the transfer pipelines have been constructed of one of three materials: high density polybutylene (HDPB), high density polyethylene (HDPE), and most recently, Teflon-lined carbon steel. Leaks generally have been associated with the solution lines constructed of HDPB and HDPE (Reference K146C, K344, K357).

Spills/Releases

Reportable and non-reportable quantity releases of manganese solutions have occurred from the pipelines throughout the life of Leach Plant operations. Leaks resulted from corrosion, fatigue, and stress failure of the pipe (Reference K146C, K357).

The following are examples of the documented releases on file:

February 25, 1986; approximately 5,500 gallons of anolyte solution containing 139 gallons (2130 pounds) of sulfuric acid were released to the ground surface. The release occurred when an anolyte transfer line separated. The RQ for sulfuric acid is 1,000 pounds (Reference K140A, K170).

- o A buried anolyte transfer line has been the source of numerous small leaks (Reference K146A).

6.12.2 Analysis of Response Measures

KMCC release response actions included implementing one or more of the following measures depending upon the size of the release (Reference K140A):

- o stopping liquid flow in the leaking line by activating proper process controls;
- o using manganese tailings from the on-site, nonhazardous manganese tailings area to contain, neutralize, and absorb the released liquid;
- o neutralizing the solution with either lime or soda ash;
- o testing the remediated material for nonhazardous pH conditions and subsequently disposing the material in the on-site, nonhazardous manganese tailings area; and
- o notifying appropriate agencies of the release and mitigative measures taken.

The above listed response actions appear to be appropriate for the initial mitigation.

More recently, KMCC began to replace the HDPB and HDPE piping with Teflon lined carbon steel piping. KMCC has also instituted a program of regular visual inspections by operating personnel to monitor the above ground transfer lines for leaks (Reference K146A, K357).

6.12.3 Contaminant Migration Pathways

The contaminant migration pathways, due to leaks in the solution transfer lines, include soil and possibly groundwater.

6.12.4 Evidence of Existing Environmental Impacts

The soil is visibly stained along portions of the transfer lines (Reference SR, September 10, 1991).

A review of the 1985 hydrogeological report prepared by KMCC reveals that shallow groundwater beneath the Leach Plant area exhibited elevated conductivity values (Reference K167; Section 6.9.4 of this report).

6.13 AP Plant Area Screening Building, Dryer Building, and Associated Sump

6.13.1 Description of Spill/Release

Background

The D-2 building (the product screening building) and its neighboring building (the dryer building) share a common sump and floor drain system. The sump servicing both the dryer building and the screening building is located adjacent to the north side of the dryer building. The grid coordinate for the location of the sump, dryer building and screening building is B8-10 on Map 6-1. The dryer building, screening building, and the sump were constructed as part of the original ammonium perchlorate (AP) plant during the early 1950's (Reference K164; SR, September 10, 1991).

The sump is situated in a topographically low area and is constructed of fiberglass reinforced plastic (FRP). This sump collects washdown water as part of the process. This sump is equipped with automatic level control and pumping devices.

Spills/Releases

Releases in this area occurred from two activities: (1) washdown operations in the dryer building and screening building, and (2) sump overflows. The liquid released is water containing dissolved AP (Reference K357).

The slope of the concrete floors in each building is such that when operators wash down the area with water, some water does not flow into the floor drain as a result of poor drainage patterns. Some of the water flows out of the building away from the buildings' floor drains. This occurs in both the dryer building and the screening building. The concrete floors and the asphalt outside of each building have white stains caused by the deposition of AP after the water has evaporated. (Reference SR, September 10, 1991).

Additionally, the sump has overflowed on occasion as a result of excessive washdown water (Reference K357).

6.13.2 Analysis of Response Measures

A review of KMCC files did not reveal documentation on releases in this area or associated response measures. Kleinfelder understands that KMCC did not have formal response measures to handle the release of washwater containing AP caused by building washdown or sump overflow (Reference K357).

KMCC is in the process of correcting the drainage pattern deficiencies existing in the dryer and screening building areas so that all washwater will drain to the floor drains leading to the sump (Reference K357).

KMCC plans to address the sump overflow events by improving management control practices (Reference K357).

6.13.3 Contaminant Migration Pathways

The contaminant migration pathways are the asphalt surface, soil, and groundwater.

6.13.4 Evidence of Existing Environmental Impacts

The asphalt surface leading away from both the dryer building and the screening building was observed to be stained with a white, powder material during the SR. Visible evidence of releases from the sump were not observed (Reference SR, September 10, 1991).

6.14 AP Plant Area Tank Farm

6.14.1 Description of Spill/Release

Background

The tank farm area contains a number of vertical, open and closed top tanks used for storing various chemicals, as listed below, in support of the production of high purity AP. The storage tanks are located in the AP Plant tank farm area at grid coordinates B9-14 to B9-15 on Map 6-1 and include the following (Reference SR, September 10, 1991; K357):

- o two AP storage tanks on concrete pads built as part of the original AP Plant during the early 1950s;

- o two new AP storage tanks constructed during 1991 on a concrete pad with secondary containment;
- o a sodium perchlorate storage tank, a sodium hydroxide storage tank, and a hydrogen peroxide storage tank all constructed as part of the original AP Plant tank farm during the early 1950s; and
- o a new sodium hydroxide storage tank constructed during 1991 with secondary containment.

Spills/Releases

Small and infrequent non-reportable quantity leaks and spills have been associated with the old AP storage tanks and with the old sodium hydroxide storage tanks throughout the life of the plant (Reference K357).

The AP releases resulted from small, pinhole size leaks developing in the sides of the tanks, releasing the liquid contents onto the concrete pad and adjacent soil. The concrete pad was observed to be in poor condition during the September 10, 1991, SR (i.e. pitted and crumbled). The deteriorating pad does not adequately route liquids to the central sump (Reference SR, September 10, 1991; K357).

The central sump is situated in a topographically low area and is constructed of a sloped asphalt surface leading to a fiberglass reinforced plastic (FRP) tank. This tank collects process liquids and solid material for recycling to the process. This tank is managed as a means to facilitate material recycling.

Additionally, small, non-reportable quantity releases of sodium hydroxide have occurred during the dilution of 25 percent to 10 percent sodium hydroxide solution. The sodium hydroxide solution overflowed from the tank onto the concrete pad and onto the soil in the immediate area (Reference K357).

6.14.2 Analysis of Response Measures

Releases of AP onto the concrete pad were washed down and the washwater recycled to the process. Releases of small amounts of AP to the soil were not addressed (Reference K357).

KMCC handled releases of sodium hydroxide in one of two ways: (1) adding citric acid, or (2) no neutralization (Reference K357).

The long-term KMCC response for addressing sodium hydroxide releases was to construct a new sodium hydroxide storage tank on a concrete pad with secondary containment (Reference SR, September 10, 1991).

The long-term KMCC response for addressing AP releases was to improve the drainage system to the central sump by adding a new asphalt surface in a section of the tank farm area that was deteriorating. KMCC also constructed two new AP storage tanks (250,000 and 500,000 gallons, respectively) on concrete pads with secondary containment and sealed joints (Reference SR, September 10, 1991).

6.14.3 Contaminant Migration Pathways

The contaminant migration pathway associated with historic releases of AP and sodium hydroxide in the AP tank farm area is the soil.

6.14.4 Evidence of Existing Environmental Impacts

The soil in the tank farm area is visibly stained from historic, small, non-reportable quantity releases of AP and sodium hydroxide (Reference SR, September 10, 1991).

6.15 AP Plant Area Change House/Laboratory Septic Tank

6.15.1 Description of Spill/Release

Background

The AP Plant area change house building was constructed as part of the original AP Plant in the early 1950s and is located at grid coordinate B9-4 on Map 6-1. The change house building also contains a chemistry laboratory which was built in 1980. The change house/laboratory building has showers for operating personnel's daily use and a chemistry laboratory to support plant operations. Wastewater effluent from the showers, rest rooms, and laboratory sinks discharge to a septic tank and leach field located adjacent to the northwest portion of the building at grid coordinate B8-4 on Map 6-1 (Reference K357).

The laboratory operations include the rinsing of laboratory utensils, instruments, and equipment associated with the preparation of standards, caustic and acid solutions for pH determinations, and dilute titrants including dilute formaldehyde titrant. The rinse water discharges to the septic tank (Reference SR, September 10, 1991; K357).

Spent chemicals are not discharged to the septic system. They are temporarily stored on-site in SWMU 028, and subsequently shipped off-site in lab packs for disposal as described in Section 5.28.

Spills/Releases

Releases in this area are associated with routine sewerage from connected units to the septic tank and the surrounding leach field. Since the laboratory was constructed in 1980, the wastewater most likely contains dilute concentrations of contaminants from the laboratory's rinse water activities.

6.15.2 Analysis of Response Measures

KMCC plans to install the necessary equipment and pipelines to pump the laboratory effluent to the existing on-site sanitary sewer network that is routed to the City of Henderson POTW (Reference K357).

6.15.3 Contaminant Migration Pathways

The contaminant migration pathways associated with the septic tank and leach field include soil and possibly the groundwater.

6.15.4 Evidence of Existing Environmental Impacts

Kleinfelder did not find documentary evidence of existing environmental impacts related to the septic tank and associated leach field.

6.16 AP Plant Area Storage Pads - Fire

6.16.1 Description of Spill/Release

Background

The AP Plant storage pad consists of a flat concrete pad in an open area located a substantial distance from the nearest building or structure. The concrete pad area is used for the storage of Ammonium Perchlorate (AP) product. The storage pad area is located at grid coordinates B2-15 to B2-16 on Map 6-1. This area has been used as a storage area since the construction of the original plant in the early 1950s (Reference K164; SR, September 10, 1991).

Spill/Release

A review of the KMCC files revealed that there has been one reportable quantity release associated with the AP storage pad area. The reviewed documents revealed the following information (Reference K158B):

- o July 18, 1990, a fire occurred in the AP storage pad area in which a 55-gallon drum containing AP initiated decomposition throughout the Pad 18 area. Approximately 100 tons of AP was stored in four hundred 55-gallon drums in the area. The decomposition of AP created a fire releasing hydrogen chloride fumes. Hydrogen chloride is listed as a Extremely Hazardous Substance (SARA Section 302(a)) and as a Hazardous Substance (40 CFR 117.3) with a reportable quantity release threshold of 5,000 pounds. An estimated 100 tons of AP produced 50,000 pounds of hydrogen chloride fumes released in the 45 minute duration of the fire.

6.16.2 Analysis of Response Measures

KMCC responded to control the fire and control the release of hydrogen chloride fumes.

The soil around the fire area became contaminated with ammonium perchlorate (AP) and decomposition products which were washed by the fire response water. The firewater drained off the pad onto the soil in the surrounding area. The contaminated soil was subsequently removed, placed into drums, and hauled off-site for disposal as nonhazardous waste at a hazardous waste landfill (Reference K158B, K357).

6.16.3 Contaminant Migration Pathways

The contaminant migration pathway, as a result of "depositional" releases associated with this fire, is the soil.

6.16.4 Evidence of Existing Environmental Impacts

Kleinfelder did not find documentary or visual evidence of existing environmental impacts as a result of the fire at the AP Plant storage pad. Impacted soil was removed and disposed (Reference K357).

6.17 AP Plant Area Old Building D-1 - Wash Down

6.17.1 Description of Spill/Release

Background

The old D-1 building is located at grid coordinate B2-11 on Map 6-1. The building is used for dry material handling, mixing, and blending of ammonium perchlorate (AP). The old D-1 building was built as part of the original AP plant construction during the early 1950s (Reference K164, K357; SR, September 10, 1991).

Spills/Releases

During the material handling, mixing, and blending activities, small amounts of AP fall onto the floor of the old D-1 building. KMCC personnel routinely sweep the building floors to collect this product. On an infrequent basis, about once every other month, the old D-1 building is washed down after sweeping. The washdown water contains dissolved AP and drains out onto the asphalt pad surrounding the old D-1 building. Some of the washwater drains onto the soil adjacent to the asphalt (Reference K357; SR, September 10, 1991).

6.17.2 Analysis of Response Measures

Kleinfelder understands that KMCC does not have formal response measures to control run-off of washdown water from the old D-1 building onto the asphalt and adjacent soil. However, mitigative measures employed by KMCC include sweeping the floors prior to washdown to greatly reduce the amount of AP that may be present in the washwater (Reference K357).

Additionally, the activities occurring in old D-1 building are anticipated to be relocated to the new KMCC Apex, Nevada facility (Reference K357).

6.17.3 Contaminant Migration Pathways

The contaminant migration pathways associated with the old D-1 building washdown activities include possible run-off from the building pad to the adjacent soils.

6.17.4 Evidence of Existing Environmental Impacts

Kleinfelder did not observe visual evidence of environmental impacts associated with the old D-1 building washdown activities. Stains were not visible on the building floor or adjacent asphalt, during the September 10, 1991 SR. The minor amount of white staining observed on adjacent soil appeared to result from spillage during material transfer (Reference SR, September 10, 1991 and August 20, 1991).

6.18 AP Plant Area New Building D-1 - Wash Down

6.18.1 Description of Spill/Release

Background

The new D-1 building is located at grid coordinate B3-11 on Map 6-1. Operations started in the new D-1 building in January 1989 and continued for approximately six months until July 1989. The new D-1 building was used for dry material handling, mixing, and blending of ammonium perchlorate (AP). The new D-1 building is equipped with a dust collection unit to capture emissions of AP from material handling activities (Reference K357; SR, September 10, 1991).

Spills/Releases

During the material handling, mixing, and blending activities, small amounts of AP not collected by the dust collector would fall to the floor. The new D-1 building was washed down on an infrequent basis after the floor had been swept. The washdown water, containing small amounts of dissolved AP, drained onto the asphalt pad outside the new D-1 building (Reference K357; SR, September 10, 1991).

6.18.2 Analysis of Response Measures

KMCC used the new building for only a short time and has discontinued use of the new D-1 building.

6.18.3 Contaminant Migration Pathways

The contaminant migration pathways associated with the new D-1 building washdown activities include the asphalt outside the building and the adjacent soil.

6.18.4 Evidence of Existing Environmental Impacts

Kleinfelder did not observe visible evidence of environmental impacts associated with the new D-1 building washdown activities (Reference SR, September 10, 1991).

6.19 AP Plant SIs and Transfer Lines To/From AP SIs

6.19.1 Description of Spill/Release

Background

The AP Plant transfer lines extend from the AP cooling towers to the five AP process surface impoundments (SIs), between these five SIs, and back to the AP process. This area is located by the following grid coordinates: B6-11 to B7-14, B4-13 to B7-15, B7-15 to B7-18, and B7-15 to B8-16 on Map 6-1 (Reference SR, September 10, 1991).

There are three types of releases associated with this area of operation: (1) cooling line breaks to and from the AP cooling towers, (2) leaks from the AP solution transfer lines, and (3) leaks from AP SIs. The cooling towers are located at grid coordinate B8-13 on Map 6-1 (Reference K357; SR, September 10, 1991).

There are five process SIs in this area; AP-1 through AP-5. These impoundments are used to concentrate dilute AP containing solutions by routing the liquor to sequentially more concentrated impoundments (Reference K158A).

SIs AP-1, AP-2, and AP-3 were initially placed into operation on May 8, 1974 (Reference UE030). The transfer lines, impoundment liners, and other equipment have been serviced, repaired or replaced on an as-needed basis over time (Reference K037, K065, K210, K212, K214).

Spills/Releases - Pipelines

On rare occasions the AP solution lines to and from the cooling towers have broken and released AP solution to the ground in the surrounding area. Other pipeline breaks between the process area and the SIs have resulted in releases to the ground (Reference K357).

Three types of transfer line materials are used in the AP area: (1) the permanent, rigid lines constructed of FRP, (2) the flexible, temporary lines constructed of HDPE, and (3) the permanent lines constructed of Transite^R/concrete (Reference K357).

Poor connections in the HDPE flexible lines and at the pumping station couplings have also contributed to small releases of AP solution (Reference K357).

Spills/Releases - Surface Impoundments

Documentation of leakage from process impoundments AP-1, AP-2, and AP-3 was found (Reference K037, K065, K210, K214). Impoundment AP-2 leaked in 1979. The single liner was subsequently replaced with another single liner for both SI AP-2 and AP-3 prior to June 19, 1980 (Reference K037, K065, UE024). Impoundments AP-1 and AP-3 required frequent patching by late 1983 to mitigate leaks that had developed. These two SIs (AP-1 and AP-3) were removed from service and the liners replaced with new double liner systems. KMCC monitors these SIs for leaks on a routine basis and reports results in their NPDES permit DMR's (Reference K158A, K210).

6.19.2 Analysis of Response Measures

An August 17, 1982 KMCC letter to the NDEP listed the following response measures employed to evaluate a surface impoundment for suspected leakage (Reference K065):

- o a review of operational activities is conducted to learn whether an activity or event could have occurred leading to a potential puncture in the SI's lining;
- o the SI is isolated from service, or if kept in service, the liquid volumes added to the SI are recorded;

- o the SI level is more carefully tracked for comparison with the estimated level change expected due to evaporation;
- o the SI is sampled on an accelerated schedule to determine if an inventory change, indicative of a leak, takes place; and
- o the findings are evaluated. If these procedures reveal that a leak exists, the SI is drained and the liner is either repaired or replaced.

These response measures were employed in 1979 and confirmed that impoundment AP-2 was leaking. Initially the liner was repaired and subsequently replaced prior to June 19, 1980 (Reference K065, UE024).

In addition, as an overall response measure and as required by its NPDES permit, KMCC maintains a groundwater monitoring program associated with single lined surface impoundments such as AP-2 (Reference K158A, K305, K320).

6.19.3 Contaminant Migration Pathways

The contaminant migration pathways associated with releases of AP solution lines to and from the AP cooling towers, pump stations, and surface impoundments are to soil and groundwater.

6.19.4 Evidence of Existing Environmental Impacts

Soils are visibly stained along portions of the transfer lines, in the immediate area of the cooling tower, and in the immediate area of the transfer line pump stations (Reference SR, September 10, 1991).

A review of groundwater monitoring summary information provided in NPDES permit discharge monitoring reports in 1985 and 1986 reveals elevated concentrations of AP, sodium chloride, and conductivity at the AP impoundment area downgradient monitoring wells M-15, M-25 (Reference K320). These AP impoundment area downgradient monitoring wells could not confirm a definite source of the impact as being any particular impoundment. Concentrations of AP in downgradient groundwater monitoring wells were relatively constant and somewhat elevated compared to upgradient monitoring wells during the 1987-1989 period (Reference K320).

These findings are somewhat consistent with those in the 1985 hydrogeologic report prepared by KMCC showing shallow groundwater conductivity impacts throughout this portion of the AP process area (Reference K167). The NPDES system monitoring graphs also show a general trend of increasing conductivity values (in each of the three monitoring wells) from 1985 through 1990 (Reference K305, K320).

6.20 AP Plant Transfer Lines to Sodium Chlorate Process

6.20.1 Description of Spill/Release

Background

AP Plant transfer lines extend from the AP Plant tank farm area to the main chlorate process area in Unit 3. These lines traverse a long distance through the KMCC facility along the grid coordinates: B9-14 to C1-14; C1-14 to C1-17; C1-17 to C9-17; C9-17 to D2-18; D2-18 to D2-12 on Map 6-1. These lines consist of flexible HDPE pipe (Reference K357; SR, September 10, 1991).

Prior to January 1976, AP Plant facility waste streams were discharged directly to the Beta Ditch (Reference K037, K056). These discharges typically consisted of solutions of sodium chloride and sodium hypochlorite formed from a chlorine gas scrubbing operation occurring in the tank farm area.

In January 1976, the KMCC facility achieved a "zero discharge" status for industrial wastewater and the routing of these AP plant tank farm waste streams into the Beta Ditch was discontinued (Reference K037, K056). These solutions were rerouted for use in the facility sodium chlorate process (Reference K357).

Spills/Releases

The releases associated with the AP Plant sodium chlorate process are therefore separable into two time periods: (1) releases prior to 1976 involving discharge of sodium chloride and sodium hypochlorite solution into the Beta Ditch and subsequently to the BMI ponds, and (2) post 1976 releases comprised of leaks in the flexible HDPE lines resulting from structural failure and fatigue causing pinhole-size leaks in the pipelines. Several small, non-reportable quantity solution spills have occurred as a result of such pipeline leaks (Reference K357).

6.20.2 Analysis of Response Measures

KMCC conducts periodic visual checks of the transfer lines to detect leaks of neutralized sodium hypochlorite. When a leak is detected, KMCC promptly responds by stopping flow in the transfer line and repairing the leak. The small amount of released solution is typically left on the ground at the spill point (Reference K357).

6.20.3 Contaminant Migration Pathways

Prior to 1976, the contaminant migration pathway was the Beta Ditch to the upper BMI ponds, soil, and groundwater.

Since 1976, the release is to soil in the immediate area of the transfer line leaks.

6.20.4 Evidence of Existing Environmental Impacts

Pre-1976 environmental impacts potentially associated with AP tank farm discharges of sodium chloride and neutralized sodium hypochlorite are infiltration of dissolved inorganic constituents along the Beta Ditch and upper BMI ponds (Reference UB001, UB008, UB015).

Kleinfelder did not observe visual evidence of environmental impacts associated with the releases from the transfer pipelines (Reference SR, September 10, 1991).

order@enviroincorp.com, 29-Dec
18:17

T

7.0 MISCELLANEOUS ACTIVITIES

General

The following subsections provide information regarding several past or present miscellaneous activities conducted by KMCC or its tenants. These activities include KMCC disposal in common areas; use of the storm sewer and acid drain systems; the on-going chromium remediation program; decommissioning of the old sodium chlorate plant; and descriptions of tenants operations.

This section has sixteen (16) subsections. The information used to develop these subsections was obtained from a review of documents, interviews, and site reconnaissance. Few documents were found describing tenant activities. Therefore, the majority of the tenant activity descriptions are based on information developed from site reconnaissance, interviews, and environmental compliance audits. Each subsection provides the following information:

- o history and description of the activity;
- o results and analysis of the activity; and
- o potential or known releases or environmental impacts related to the activity.

7.1 BMI Common Area Disposal (Upper and Lower BMI Ponds)

7.1.1 History and Description of Activity

The BMI ponds are located north-northeast of the BMI complex. These waste management ponds cover a large area between Boulder Highway, Lake Mead Drive, and the Las Vegas Wash and were unlined. The terms "upper" and "lower" BMI ponds refers to the physical location of a system of ponds relative to the Las Vegas Wash and the BMI complex. The lower BMI ponds abut the Las Vegas Wash whereas the upper BMI ponds are positioned closer to the BMI complex (Reference Plate 3-1).

Construction of the upper and lower BMI ponds appears to have been completed by April 18, 1943 (Reference UB003, K164). These unlined ponds were designed for managing industrial wastewater originating from the BMI complex (Reference UL020).

The need for the BMI ponds was realized after the existing disposal system (the four "Trade Effluent" evaporation/setting ponds located on the BMI complex) was deemed inadequate. An error was made in the evaporation calculation during design of the four "Trade Effluent" evaporation/setting ponds. Therefore, the upper and lower BMI ponds were designed and built to replace the existing disposal system (Reference UL020).

The main route of discharge to the BMI ponds was via a system of open surface ditches and subsurface siphons. Process aqueous wastes were first discharged to the "Beta Ditch", an unlined east-west drainage ditch (Reference Section 5.20 of this report). Aqueous wastes entering the Beta Ditch flowed by gravity to the east to a siphon near the Boulder Highway. The siphon transmitted the wastewater under Boulder Highway to another unlined open surface ditch (The "Acid Ditch") which paralleled the southern margin of the upper BMI ponds. Aqueous wastes were then routed to ponds within the upper or lower BMI pond system via a distribution ditch within the pond system. KMCC believes the majority of KMCC wastes were routed to the upper BMI ponds (Reference K056, K164, UE060).

The main route of discharge to the BMI ponds (as described above) was also used by the various neighboring operating companies and tenants within the BMI complex. Aqueous waste streams from these various companies entered the Beta Ditch where they were commingled enroute to the BMI ponds (Reference K056).

The BMI ponds received slurried waste from the BMI complex beginning in approximately 1942 or 1943 until the mid 1970s when each of the operating companies was required to effect a "zero discharge" industrial wastewater management status. In addition to waste streams generated by U.S. Government operations and the City of Henderson Sewage Treatment Plants (STP) #1 and #2, discharges to the BMI ponds included in excess of 5 million tons of liquid wastes from sources including: WECCO operations of 1945 to 1955; AP & CC operations of 1956 to 1967; KMCC operations of 1967 to 1975, and several neighboring companies (including Stauffer, Montrose, U.S. Lime, and Timet) and Tenants (including State Industries) between approximately 1945 and 1976. In January 1976, KMCC's industrial wastewater discharges to the BMI ponds were ceased in accordance with NPDES Permit NV 0000078 (Reference C001, K032, K037, K039, K056, K179, K347, UE060, UE088, UE104, UL001).

Detailed information on U.S. Government waste generation and disposal was not found by Kleinfelder during this study. However, reviewed documents indicate the effluents included both acid and caustic liquors. The acid effluent was comprised of hydrochloric acid generated from wash towers in the chlorination portion of the magnesium "metal units". The caustic waste was comprised of caustic liquor which was used in associated acid absorber towers (Reference UL020).

Municipal and industrial sewage effluents have also been disposed of in the upper and lower BMI ponds since 1942. BMI operated a sewage treatment plant (STP #2) until approximately 1972/1974 when the City of Henderson assumed operation (Reference UE061, UE143). Effluent from STP #2 had been discharged to the upper BMI ponds (Reference UE143). The City of Henderson has operated another sewage treatment plant (STP #1) since 1958 and discharged treated effluent to the lower BMI ponds (Reference UE059, UE143).

State Industries periodically discharged liquid wastes to the Beta Ditch through the acid drain system between June 1970 and December 1974. From June 1970 to September 1972, approximately 35,000 gallons of pickling process wastes were discharged each month. Monthly discharges consisted of approximately 2,500 gallons of spent sulfuric acid, 300 pounds of borax, 500 pounds of soda ash and 4,000 pounds of phosphate chemicals. Between June 1970 and October 1971 State Industries also periodically discharged neutralized and unneutralized waste cyanide solutions to the Beta Ditch through the acid drain system. These discharges contained approximately 176 pounds of cyanide. Additionally, between June 7 and December 10, 1974, State Industries discharged surface impoundment contents to the acid drain system on three occasions to facilitate liner repairs (Reference K298, K300, K301, K302, UE103, UE114; Section 7.6 of this report).

Records indicate WECCO, AP & CC, and KMCC discharged various wastes to the BMI ponds between 1945 and January 1976 (Reference UE088). Detailed information regarding the quantity of waste and location of waste disposal is not known by KMCC because BMI managed the pond usage (Reference K056). However, based on a 1970 NPDES report, it was extrapolated that the combined effluent discharged by WECCO, AP & CC and KMCC to the BMI ponds prior to January 1976 is believed to be approximately 600,000 gallons per day (Reference K037). The average content of this effluent was reported to the EPA by KMCC and is shown in Table 7.1.1.

Table 7.1.1

**Average Discharge to the Beta Ditch (Pre-January 1976)
 (Reference K037)**

<u>Parameters</u>	<u>Mass Flow (Pounds per day)</u>
Total Dissolved Solids (TDS)	19,100
Suspended Solids	1,080
Total Solids	20,200
C.O.D. (Chemical Oxygen Demand)	110
NH ₃ (Ammonia)	35
Calcium	2,000
Iron	1,100
Potassium	1,200
Sodium	5,000
Magnesium	150
Zinc	130
Manganese	1,800
Nickel	8
Lead	4
Copper	4
Cobalt	1.5
Chromium	0.3
Phosphorous	0.4

Discharges to the BMI ponds did not contain manganese dioxide process wastes. The aqueous waste streams discharged to the BMI ponds were generated from the manufacturing of chlorates, perchlorates, and boron products (Reference K037, K039, K056, K179).

The aqueous waste streams generated from the manufacture of chlorate and perchlorate products contained (Reference K056):

- o soluble salts including sodium chlorate, sodium chloride, potassium chloride, and ammonium perchlorate;
- o less soluble salts including calcium carbonate and calcium sulfate; and
- o insoluble materials including carbon and diatomaceous earth filter aid.

The waste originating from the sodium chlorate process also contained upwards of 0.05% by weight hexavalent chromium. KMCC records indicate that 391,000 cubic feet of solid chlorate wastes were sluiced to the BMI ponds prior to 1975 (Reference K037, K179, UE083).

Perchlorate wastes from the various perchlorate processes were also sluiced to the BMI ponds at various times. An unknown quantity of ammonium perchlorate process waste was sluiced to the BMI ponds between 1951 and 1974. Approximately 293,800 tons of potassium perchlorate waste was also sluiced to the BMI ponds between 1945 and 1976 (Reference K170, UE024, UE083).

The aqueous waste stream generated from the manufacture of boron products between 1972 and 1976 contained magnesium, sodium, sulfate, and boron ions and a wet scrubber stream. KMCC estimates approximately one million gallons of aqueous waste generated from this process between 1972 and 1976 was discharged to the BMI ponds (Reference K039, K179, UE083).

7.1.2 Results and Analysis of Activity

The use of the upper and lower BMI ponds for routine waste disposal purposes occurred between approximately 1942 and December 1976 (Reference K056, K347, UE073, UE107). The wastes discharged by the U. S. Government between approximately 1942 and 1945 included acid effluent and caustic effluent (Reference UL020). Wastes generated by KMCC (and their predecessors, WECCO and AP & CC) and the other operating companies and tenants between approximately 1945 and prior to January 1976 were commingled within the Beta Ditch prior to discharge to the BMI ponds (Reference K056, K347). Because BMI managed the pond system between May 1952 and December 1976, KMCC did not generate records regarding which ponds were used for its waste disposal (Reference K056, UE073).

The historic waste management activities resulted in the disposal of various company waste streams as commingled wastes in numerous different individual unlined ponds within the upper and lower BMI pond system. The exact individual ponds used for disposal, the time period of disposal, and the quantity and quality of waste constituents disposed are not known by KMCC or BMI (Reference K056, UE073, UE085, UE107).

Information regarding the types of waste disposed to the BMI ponds will be addressed separately by each company involved in ECAs.

The sodium chlorate filter cake generated by KMCC and its predecessors (containing approximately 0.05% by weight hexavalent chromium) was sluiced to the BMI ponds from 1945 to 1975. During this time, an estimated 391,000 cubic feet of sodium chlorate filter cake waste, containing hexavalent chromium, was disposed in the BMI ponds (Reference K179).

The presence of hexavalent chromium within the upper BMI ponds also can be attributed to two types of discharges from the old main cooling tower; (1) cooling water containing chromium added as a corrosion inhibitor, and (2) process solution spills. Approximately 1,000 to 1,300 pounds of sodium dichromate was routed to the upper BMI ponds in May 1980 when the main cooling tower was purged due to safety concerns as a result of a spill of chlorate process solution into the cooling water. The purge water contained sodium chlorate process solutions as a result of a gasket failure (Reference K038).

Another source of discharges to the lower BMI ponds is the "Pittman Underdrain". A four-inch diameter pipe which connected to the underdrain and discharged to the lower BMI ponds was sampled by Ecology and Environment, Inc. (E & E) and analyzed in February 1982. The analyses revealed detectable concentrations of several inorganic and organic constituents. The presence of these constituents may be attributed to the underdrain draining contaminated groundwater (Reference UE097, UE098, UE099).

7.1.3 Potential or Known Releases or Environmental Impacts Related to Activity

Several separate soil sampling events of the BMI ponds were initiated by the U.S. EPA. The first sampling event was conducted in 1980 by J.R.B. Associates. Another sampling event was conducted in 1985 by Ecology and Environment, Inc. (E & E). Both sampling events yielded similar information and revealed the presence of elevated concentrations of total chromium and lead in surface soil samples collected from the upper and lower BMI ponds. Hexavalent chromium was not specifically sampled for in either of these sampling events (Reference K179, UE062).

J.R.B. Associates also conducted surface water and groundwater sampling in 1980 in the vicinity of the Las Vegas Wash at locations downgradient from the BMI ponds. These data revealed concentrations of total chromium in surface water and groundwater at values between 2 and 20 times background (Reference K179).

The following findings were reported by E & E in a March 15, 1990 report based on analytical data and other background information obtained (Reference K179):

- o chromium has been detected in surface soil samples collected from both the upper and lower BMI ponds. The total extent of chromium contamination is unknown. However, because the waste was discharged as a liquid, it is possible that the waste spread over a large area of the ponds;
- o the source of total chromium detected in the groundwater and surface water samples appears to be the BMI ponds;
- o the release of chromium to the Las Vegas Wash could have occurred by migrating groundwater or migrating surface water run-off from the BMI ponds;
- o although there is no documented release of contaminants from the BMI ponds to the air pathway, this potential exists. The BMI ponds are dry, uncovered, and contaminated with waste constituents at the surface. Residential portions of Pittman and Henderson are within less than 0.5 miles of the BMI ponds; and
- o the BMI ponds pose a potential for on-site exposure. There is no continuous barrier to entry. Footpaths and off-road vehicle trails extend onto portions of the BMI pond system. The total area of contamination is unknown, however, the potential area of contamination is large due to the method of waste disposal.

7.2 BMI Common Area Disposal (BMI Landfill)

7.2.1 History and Description of Activity

The BMI landfill is located near the central portion of the BMI complex (Reference Plate 3-1; UE024). The BMI landfill is situated upon an area formerly used as a "Trade Effluent" evaporation/settling pond during U. S. Government era operations. Solid wastes may have been placed in this area prior to 1950, however, BMI began operation of this disposal area in May 1952 (Reference K164, UE073, UE086, UE107). Prior to July 1970 solid waste was disposed in open pits within the BMI

landfill and periodically burned (Reference UE086). Between July 1970 and November 1979, solid wastes were disposed in trenches and pits within this landfill and subsequently covered (Reference UE086).

The BMI landfill was closed on February 29, 1980 (Reference UE073, UE086). During the operating life of this landfill, industrial wastes were received from the various operating companies (including KMCC) and tenants (Reference K056, UE024). Both solid and liquid wastes were received by the BMI landfill (Reference UE059).

A "Notification of Hazardous Waste Site" form submitted by BMI to the U.S. EPA dated June 1, 1981 included the following listing of parties that used the BMI landfill area between 1941 and 1980 (Reference UE086):

- o U.S. Defense Plant Corporation;
- o Nevada Colorado River Commission;
- o U.S. Bureau of Reclamation;
- o Hardesty Chemical Company;
- o U.S. Vanadium Company;
- o Kerr-McGee Chemical Corporation and predecessors, namely, American Potash and Chemical Company and Western Electrochemical Company;
- o U.S. Navy;
- o Titanium Metals Corporation of America and predecessors, namely, National Lead Corporation and Pioche Manganese Company;
- o Flintkote Lime Company and predecessor, U.S. Lime Company;
- o Stauffer Chemical Company;
- o Montrose Chemical Company; and
- o Jones Chemical Company.

KMCC utilized the BMI landfill primarily to dispose of housekeeping wastes including paper, cartons, bags, pallets, drums and plastics (Reference K056). Prior to 1970, these wastes were periodically burned at the BMI landfill. From 1970 through 1980, these wastes were buried by landfill procedures (Reference K056). Kerr-McGee disposed an estimated 75 cubic yards per week of Class A combustible material and 3

cubic yards per week of non-combustible rubble in the BMI landfill (Reference K022). The Class A combustible material typically included paper, cartons, bags, pallets, drums, and plastics (Reference K022, K056). KMCC also disposed of asbestos containing material in the BMI landfill in late 1979 with CCHD approval (Reference UE080).

From 1975 to 1979, approximately 100,000 pounds of elemental carbon powder generated from the boron operations was disposed in the BMI landfill (Reference K039, UE083). These nonhazardous industrial wastes have since been managed through off-site disposal at the Clark County Sanitary Landfill (Reference K056).

Filter cake from the sodium chlorate operations were disposed in the BMI landfill from February 1975 through February 1980 after the BMI ponds were removed from service. This waste contained chiefly diatomaceous earth with amounts of chlorate salts, approximately less than 5 percent soluble chloride, and approximately 0.05% by weight hexavalent chromium. Approximately 1-1/2 to 2 tons of this waste were generated per day and approximately 90,000 cubic feet were subsequently disposed in the BMI landfill. After closure of the BMI landfill in 1980, these wastes were landfilled at the KMCC hazardous waste landfill (February 1980 to January 23, 1983) or disposed off-site at the U.S. Ecology, Inc. facility in Beatty, Nevada (1983 to present) (Reference K056, K130, K179, K268, UE083).

An estimated 50 tons of dried residues from the cleaning of surface impoundments P-1 and AP-2 were also disposed in the BMI landfill (Reference K039, UE083). This occurred when both surface impoundments were rebuilt prior to May 1980 (Reference K037). These wastes were buried in the southern portion of the BMI landfill (in an area designated as Area #2B by E & E in a Phase IIB sampling plan dated May 10, 1985) (Reference UE146).

7.2.2 Results and Analysis of Activity

Kleinfelder did not find detailed records regarding the design, operation and closure of the BMI landfill during this study. The BMI landfill received a variety of wastes from the various operating companies and tenants throughout its operating life (Reference UE086). A March 31, 1982 letter from BMI to the NDEP references an attached map (not included in the reviewed document copy) with the approximate locations of

trenches and areas used for disposal by individual companies (Reference UE107). Geraghty & Miller, Inc. later provided a copy of this map which they obtained during document review activities (Reference C002). Each trench was approximately 12 to 24 feet wide, up to 400 feet long, with a maximum depth of 20 to 24 feet (Reference GM003, UE107). The BMI landfill may have received solid wastes prior to 1950 and was closed on February 29, 1980 (Reference K164, K179, UE073, UE079, UE086). Closure included covering of solid waste areas with two to fifteen feet of waste lime, covering the lime with a minimum of two feet of soil, grading, and restricting entrance by a fence and locked gate (Reference GM004, UE086, UE107).

7.2.3 Potential or Known Releases or Environmental Impacts Related to Activity

Kleinfelder did not find records of known releases from the BMI landfill. Warning signs are posted and the area is fenced and locked to restrict public access (Reference K179, UE078, UE080, UE086, UE107). Closure of the BMI landfill occurred on February 29, 1980 (Reference UE073, UE079). Potential releases to the air and surface water pathways have been reduced due to closure.

Information regarding the types of waste disposed to the BMI landfill will be addressed separately by each company involved in ECAs.

7.3 Old Sodium Chlorate Plant Decommissioning

7.3.1 History and Description of Activities

Sodium chlorate production occurred in 1,300 electrolytic cells in Units 4 and 5 from 1945 to November 1989 (Reference Plate 3-2). The process liquids contained sodium dichromate to enhance electrolytic conversion (Reference K105).

Retention of process liquids in the basements of Units 4 and 5 and seepage from the basements and sump areas has been identified as the source of a chromium bearing plume in the groundwater (Reference K091, K105). In order to control this source of chromium in groundwater and improve process efficiencies, remedial activities were initiated and a new sodium chlorate process was designed and installed in Unit 3 (Reference K091, K105). In November 1989, sodium chlorate production ceased in Units 4 and 5. The process equipment was being dismantled during a September 18, 1991, SR.

Process equipment including electrolytic cells, tanks, piping, pumps, and related hardware were being decommissioned, cleaned, and removed during a September 18, 1991, SR. The electrolytic cells and some associated piping were being drained in place followed by the addition of cement to dry, stabilize, and solidify residual materials which remained. Cells were either removed and placed directly onto a plastic (visqueen) lined flatbed truck, covered, and shipped to a hazardous waste landfill at Beatty, Nevada or were placed in a staging area prior to loading (Reference K357; SR, September 18, 1991).

Other process equipment (tanks, piping, and pumps) were being cleaned, dismantled, and transported for off-site disposal or recycling dependent upon the degree of decontamination. Building areas are being cleaned and made available for other uses (Reference K357).

7.3.2 Results and Analysis of Activities

Decommissioning of the old sodium chlorate process eliminates the source of environmental impact due to chlorate production in Units 4 and 5. The decommissioning, dismantling, and disposal of the old process equipment is an activity which was on-going during a September 18, 1991, SR.

7.3.3 Potential or Known Releases or Environmental Impacts Related to Activity

Routine process operation and maintenance activities resulted in historic spills and releases of sodium chlorate solutions to the basements of Units 4 and 5 (Reference K091, K105).

7.4 State Industries, Inc. (KMCC Tenant)

7.4.1 History and Description of Activity

State Industries, Inc. leased portions of the KMCC property south of Units 2 and 3 for the manufacture and storage of hot water heaters. This area is located approximately 1,200 feet south of Units 2 and 3, approximately 1,000 feet north of Lake Mead Drive, and approximately 300 feet west of the Kerr-McGee main entrance road (Reference Plate 7-3). This area is fenced and the gate is locked (Reference SR, August 20, 1991). State Industries operated in this area from 1969 to approximately November or December 1988 (Reference K263, UE070, UE103).

The areas leased by State Industries included portions of Unit 1; Buildings T-4, T-5, and T-8; and a relatively large open area near the southwestern portion of the KMCC site (Reference Plate 7-3; K263, K164, UE103, UE114). Approximately one-half of the Unit 1 building was leased to State Industries to store water heaters (Reference K092).

An April 14, 1980 letter from State Industries to the City of Henderson, Director of Public Works listed the following raw material usage at this facility, see Table 7.4.1 (Reference UE071).

Table 7.4.1
State Industries, Inc.
Estimated Annual Usage of Raw Materials (1980)
(Reference UE071)

<u>Raw Material</u>	<u>Estimated Annual Usages</u>	
Raw steel	40,451,262	pounds
Insulation	8,996,588	sq. ft.
Paint	49,820	gal.
Paint thinner	132,000	gal.
Glass material	1,825,300	pounds
TURCO II H.T.C. Soap	53,350	pounds
Sulphuric acid	34,200	gal.
Soda ash	6,000	pounds
Borax	4,000	pounds
Fab. Lubricant	55,000	pounds
Gear Lubricant	2,000	pounds

From June 1970 to September 1972, State Industries is known to have used the acid drain system to convey various process wastes to the Beta Ditch (Reference K265, K302, UE103). A March 23, 1982 letter from State Industries to the NDEP indicates that during this time, monthly discharges of process waste to the acid drain system averaged approximately 35,000 gallons and included 2,500 gallons of spent sulfuric acid, 300 pounds of borax, 500 pounds of soda ash, and 4,000 pounds of phosphate chemicals (Reference UE103, UE108).

Liquid waste containing spent cyanide was also periodically discharged to the acid drain system between June 1970 and October 1971 (Reference UE103, UE114). During this time, approximately 176 pounds of cyanide was mixed with water and used as a rust

preventative (Reference UE103, UE108, UE114). The solution containing waste cyanide was typically mixed with calcium hypochlorite to destroy the cyanide prior to discharge to the acid drain system (Reference K302). However, on June 21, 1971, a tank of waste cyanide which had not been neutralized was apparently discharged accidentally to the acid drain which subsequently emptied into the Beta Ditch (Reference K302).

State Industries', permit to discharge industrial wastewater to surface waters (NPDES Permit No. NV 0000108) expired June 1, 1974 (Reference K298). After June 1, 1974, all wastes were to be ponded on-site (Reference K298).

State Industries operated two surface impoundments (SIs), "western" and "eastern", between June 1974 and December 1988 (Reference K161, K164, K171, K281, K298). The actual dates of operation of each SI are not known.

A May 1981 EPA Region IX inspection report and a March 23, 1982 letter from State Industries to the NDEP indicates that both surface impoundments (SIs) were lined with single liners consisting of PVC bottoms and reinforced butyl rubber sides. The western SI was circular and measured approximately 130 feet in diameter. The eastern SI was rectangular and measured approximately 150 feet by 250 feet (Reference K281, UE103).

The SIs received spent pickling process wastes (for solar evaporation) generated during the manufacture of water heaters (Reference K281, K282, K283). The process wastes were pumped to the SIs at a rate of approximately 35,000 gallons per month and included spent sulphuric acid, borax, soda ash (anhydrous sodium carbonate), phosphates (chemical combinations), and TURCO II H.T.C. soap (Reference ND053, ND054, UE103). A graduated stand pipe was used to record daily changes in SI levels and monitor these systems for leaks. Although the actual dates of operations of each SI are not known, records indicate that one of the SIs was in operation by September 1972, and both SIs were in operation on August 2, 1979; May 19, 1981; and March 23, 1982. The western SI was closed and covered by a 20,000 square foot warehouse in approximately late 1983. The eastern SI was closed by December 1988. Closure of the eastern SI was conducted by mixing the contents with soil until the material solidified (Reference K161, K164, K171, K281, K298, K357, UE103, UE114).

The actual dates of operation of each SI are not known. However, records indicate that one of the SIs was in operation by September 1972, and both SIs were in operation on August 2, 1979; May 19, 1981; and March 23, 1982. The western SI was closed and covered by a 20,000 square foot warehouse in approximately 1983. The eastern SI was closed by December 1988. Closure of the eastern SI was conducted by mixing the contents with soil until the material solidified (Reference 161, K164, K171, K281, K298, K357, UE103, UE114).

A State Industries inter-office correspondence dated August 14, 1980 indicated the need to report to EPA by August 18, 1980 that the wastewater discharged to a surface impoundment had a pH value of 1 (Reference K289). A subsequent letter from State Industries to the U.S. EPA Region IX dated November 3, 1980, requested that their status as treaters of hazardous waste be recinded because they had since studied their processes and determined that they were not creating a hazardous waste that needed treatment (Reference K290).

U.S. EPA and NDEP inspection reports for May 19, 1981, November 14, 1985, and January 15, 1987, indicate that sulfuric acid wastes were neutralized in a catch basin by injecting caustic soda to form wastewater with a pH greater than 2.0 prior to discharge to the SIs (Reference K281, K282, K283). However, some records indicate that there were instances where wastewater was discharged to the SIs (circa 1980 and prior) with a pH of approximately 1.0 (Reference K281, K289).

Limited trace metal analyses performed by State Industries on samples of wastewater in July 1981 and May 1982 revealed a high concentration of iron, detectable concentrations of total chromium and barium, and non-detectable concentrations of arsenic, cadmium, lead and selenium (Reference UE103, UE114).

Prior to closure of the eastern SI, sludge samples were collected and analyzed. Laboratory analysis of the sludge from the eastern SI in July 1988, by EP Toxicity procedures detected nonhazardous concentrations of arsenic, lead, nickel and selenium (Reference K171). State Industries subsequently managed the sludge as nonhazardous industrial solid waste based on the results of the EP Toxicity analyses (Reference K171).

Both surface impoundments have been closed. A State Industries letter to KMCC dated November 4, 1988, indicates that remedial action conducted on the eastern surface impoundment has been accepted by the EPA (Reference K171). An NDEP internal record of communication dated January 31, 1989, indicates that NDEP had no data on the closure (Reference K286).

One of the State Industries SIs is known to have leaked on three separate occasions between June 7 and December 10, 1974 (Reference K298, K300, K301). The reviewed documents do not indicate which SI (western or eastern) experienced the leakage. Discharges to the acid drain system were performed in order for State Industries to access and repair leaks in the SI liner (Reference K298, K300, K301).

Due to the high flow rates during the pond pump-out operation, discharges to the acid drain system apparently overflowed to the sanitary sewer (Reference K298). Documentation suggests that constituents of one of the SIs were discharged to the sanitary sewer via the acid drains on at least three occasions in 1974 to facilitate repairs to the liner after leaks were detected (Reference K295, K297, K298, K300, K301).

Review of U.S. EPA files revealed hand written notes dated May 15, 1980 which indicated State Industries had informed the NDEP of a ripped lining in an SI (Reference UE075).

7.4.2 Results and Analysis of Activity

State Industries use of portions of the KMCC property included construction and use of two surface impoundments for solar evaporation of liquid wastes and use of the acid drain system to periodically convey wastewater to the Beta Ditch. A May 1981 EPA Region IX inspection report and a March 23, 1982 letter from State Industries to the NDEP indicate that both SIs were lined with single liners consisting of PVC bottoms and reinforced butyl rubber sides. The western SI was circular and measured approximately 130 feet in diameter. The eastern SI was rectangular and measured approximately 150 feet by 250 feet (Reference K265, K281, K302, UE074, UE103).

A warehouse structure was constructed over the site of the westernmost impoundment in approximately 1983. Records were not found during this study regarding the method of abandonment of the this impoundment.

Between July 1988 and December 1988, the easternmost SI was abandoned in place by filling with soil (Reference K357). Prior to closure of this SI, sludge samples were collected and analyzed. Laboratory analysis of the sludge from the eastern SI in July 1988, by EP Toxicity procedures detected nonhazardous concentrations of arsenic, lead, nickel and selenium (Reference K171). State Industries subsequently managed the sludge as nonhazardous waste based on the results of the EP Toxicity analyses. Field observations during an August 20, 1991 SR, suggest that a sufficient protective cover in accordance with industrial waste regulations was not placed on the area of the former eastern SI during closure.

7.4.3 Potential or Known Releases or Environmental Impacts Related to Activity

Limited information has been found regarding the construction, use, and abandonment of the westernmost surface impoundment. This circular SI was lined with a single liner consisting of a PVC bottom and reinforced butyl rubber sides (Reference K281, UE103).

The construction of the easternmost surface impoundment included use of a single liner consisting of a PVC bottom and reinforced butyl rubber sides (Reference K281, UE103). During abandonment, the liner was reportedly left in place and soil was added and mixed with the contents to raise the area to existing grade. The presence of rust colored soils, several patches of yellow-white soil staining, and several pieces of liner material in the area of the former eastern SI represent visual evidence of the probable presence of former SI constituents on the land surface (Reference SR, August 20, 1991). These observations suggest that an engineered protective cover appropriate for the waste may not have been placed at the time of closure.

The potential exists for surficial constituents to migrate from the area of the former easternmost impoundment. Constituents exposed at the surface could migrate to the air pathway as particulates. These constituents could also migrate with surface water run-off. The run-off could either impact adjacent surface soil or enter nearby storm drains and empty into the Beta Ditch (Reference SR, August 20, 1991).

Several releases have been documented regarding one of the State Industries SIs. The liner leaked at least three times (June, July, and December 1974) and was subsequently repaired (Reference K298, K300, K301). The migration pathway of leakage from the

SIs would be subsurface soil. Migration to groundwater could have occurred given sufficient time and quantity of leakage during operation of the SIs. The amount of material that leaked is not known, however, the releases may have impacted the adjacent soils and shallow groundwater. The released fluids may have had a low pH (Reference K281, K289).

State Industries discharged their liquid waste to the acid drain system on several occasions through a connection in the southwest corner of Building T-5 (Reference UE114). Between June 1970 and September 1972, approximately 35,000 gallons of process wastes were discharged to the acid drain system each month (Reference UE103, UE108). During impoundment liner repairs in 1974, waste was pumped from the SI and diverted from the process area to the acid drain system on three occasions (Reference K298, K300, K301).

7.5 J. B. Kelley, Inc. Trucking (KMCC Tenant)

7.5.1 History and Description of Activity

Jack B. Kelley, Inc. (J. B. Kelley) has leased portions of the KMCC site for trucking related purposes. The lease initially operated as W. S. Hatch Company from March 1980 to August 1986 and as J. B. Kelley from September 1986 to present. The lease area has remained the same and includes Area B-8 and a portion of Area B-6 which are approximately 600 feet north of Unit 1 (Reference K263, K355; Plate 7-3).

The lease area encompasses an open gravel/soil covered area, concrete pads, and building foundations. This area is accessed by the entrance road which also provides access to Pioneer, BMI, Koch, and other entities (Reference SR, August 20, 1991; Plate 7-3).

The trucking related activities conducted by Hatch and Kelley have included the washing of truck exteriors, the washing of truck interiors, vehicle fueling, and minor repair work including oil changes. The trucks were fueled with diesel from an on-site 10,000-gallon fiberglass underground storage tank (UST). The waste oil was temporarily stored in an on-site 600-gallon porcelain ceramic lined UST (Reference K355).

Historically, the truck exteriors were washed at a truck wash area adjacent to the UST area and the washwater drained to a storm sewer drop inlet. The storm sewer conveyed the washwater to the Beta Ditch. This exterior truck washing, fueling, and maintenance area consisted of two 15 foot by 40 foot unbermed concrete pads. The area surrounding the pads consisted of an open gravel and soil covered area. This area also was formerly equipped with one 600-gallon porcelain ceramic lined underground storage tank (UST) with an attached sump for management of waste oil. In 1988, these trucking related washwater discharges to the storm sewer were discontinued at the request of KMCC and the storm drain was sealed. The truck exteriors were then washed in a soil and concrete covered area several hundred feet northwest of the former truck wash area in a location adjacent to the western side of a system of concrete vaults. This area was within the footprint of a former building and the truck washwater would have drained to the ground surface. These on-site activities were ceased in February 1991 (Reference K355, K358; SR, August 20, 1991).

Historically, the interior of selected trucks were also washed at this facility. Some of this rinsate was discharged to two metal tanks and/or a system of eight concrete vaults and some was discharged to the storm sewer. The concrete vaults consisted of eight larger and four smaller concrete vaults in an area measuring approximately 80 feet by 100 feet. The walls of the vaults were approximately 8 inches thick. Some of the vaults are hydraulically interconnected by small openings. The vault system appeared to be a portion of the remnant foundation of a building constructed and used during the U.S. Government operations. The southwesternmost vault contained two 1,000-gallon metal tanks (Reference K355, K357, K358; SR, August 20, 1991).

This tanker truck rinsate contained chemicals including lime, soda ash, barite, and magnesium chloride brine and may also have included dilute concentrations of ferric chloride, hydrochloric acid, sodium hydrosulfide, sodium hydroxide, and/or titanium tetrachloride. The rinsate (wastewater) was probably periodically neutralized with lime or soda ash and allowed to evaporate or was hauled off-site for disposal. These activities continued until approximately February 1991 when on-site wash activities ceased (Reference K355, K357, K358; SR, August 20, 1991).

7.5.2 Results and Analysis of Activity

The lessees use of this area between March 1980 and present has included the following activities (Reference K355):

- o use of a 10,000-gallon fiberglass UST to store diesel fuel;
- o use of a 600-gallon porcelain ceramic lined UST to store waste oil;
- o discharge of washwater (from washing the exterior of trucks) to both the storm sewer and the land surface and discharge of some solid residues to the land surface; and
- o discharge of rinsate containing dilute concentrations of various chemicals (from washing the interior of selected trucks) to the storm sewer, two metal tanks, and eight concrete vaults.

Trucks were fueled from a 10,000-gallon fiberglass UST containing diesel and waste oil was poured into a 600-gallon porcelain ceramic lined UST via a sump. The sump and 600-gallon UST were apparently a single unit design (Reference K355, K358).

On-site fueling operations were discontinued in June 1991 and the fuel and waste oil UST's removed. The UST sites are currently in the process of permanent closure. Both USTs removed on June 28, 1991 were found to have leaked. Surrounding petroleum hydrocarbon contaminated soils were excavated at the time of tank removal. At the time of an August 20, 1991 SR, the tanks had been removed from the site and the contaminated excavated soil was observed stored in stockpiles approximately 250 feet northeast of the truck wash area (Reference K355; SR, August 20, 1991).

The washing of truck exteriors, truck fueling, and minor repairs including oil changes has been conducted since March 1980. Historically, the exterior of trucks were washed at the truck wash area and the washwater would drain to a storm sewer drop inlet. The storm sewer conveyed the washwater to the Beta Ditch. These industrial wastewater discharges were discontinued in the summer of 1988 in response to a KMCC request. This storm sewer access was subsequently sealed. Since that time, the truck exteriors have been washed in a soil and concrete covered area several hundred feet northwest of the former truck wash area. This truck wash area is adjacent to the western side of the system of concrete vaults also operated by J.B. Kelley, Inc., and within the footprint of a former building. The practice of washing vehicles on-site was subsequently

discontinued between August 20, 1991 and October 18, 1991. Currently, the truck interiors and exteriors are washed at a nearby Magic Wand facility (Reference K263, K355; SR, August 20, 1991).

The tank washing practices consisted of rinsing the contents of certain tanker trucks into the metal tanks and concrete vaults. Some rinsate was also discharged to the storm sewer and to the ground on various occasions. The tanker trucks were rinsed to reduce corrosion and cross contamination between loads (Reference K263, K355).

Storm water run-on into the vault area is remote because the concrete vault walls extend approximately one foot above the surrounding soil and concrete. Storm water or tank rinsate run-off from these vaults would occur only if the vaults were filled and overtopped. Kleinfelder did not observe indications of such an event (overtopping) having occurred (Reference SR, August 20, 1991).

7.5.3 Potential or Known Releases or Environmental Impacts Related to Activity

Hydrocarbon releases occurred from both the 10,000-gallon diesel UST and the 600-gallon waste oil UST. The UST closure activities were being conducted for J.B. Kelley by an environmental contractor. The appropriate regulatory agencies were informed of the closure activities and were present during portions of the removal activities (Reference K355, K358; SR, August 20, 1991).

Kleinfelder did not find records of known releases of liquid waste from the eight concrete vaults which received truck tank washings. However, approximately a foot of a yellowish liquid remained in the bottom of four of the concrete vaults at the time of the August 20, 1991 site reconnaissance. Additionally, the dry vaults contained an unknown depth of sludge, presumably precipitates from the addition of lime and/or soda ash for neutralization. The vaults appeared to be constructed using cold joints between the walls and the floors and minor cracking of the concrete was evident. The metal tanks also contained some liquid. Minor seepage of liquid between the vaults was observed on August 20, 1991. This seepage was noted emanating from the base of a concrete wall separating a dry vault from an adjacent vault containing liquid waste approximately one foot deep (Reference SR, August 20, 1991).

The historic discharge of truck exterior washwater to the storm sewer system and the building pad represents known discharges. Washwater with soap and trace amounts of oil, grease, and diesel were periodically discharged to the storm sewer system between March 1980 and 1988 and the building pad between 1988 and 1991. The discharge paths would have involved the storm sewer system, the Beta Ditch, and surface soils.

Prior to early 1990, activities conducted in this area by J.B. Kelley, Inc. also included the routine sweeping or dumping of dry residues of bulk hauled materials onto the gravel covered lease area (Reference K355).

Storm water run-on/run-off from the area would flow onto this area from the south and flow towards a storm sewer drain located north-northeast of the former truck washing and maintenance facility.

7.6 Koch Materials Company (KMCC Tenant)

7.6.1 History and Description of Activities

Since May 1983, Koch Asphalt Company, also doing business as Koch Materials Company, has leased an area surrounding Building B-3 located north of the J. B. Kelley lease areas (Reference Plate 7-3). This lease was a continuation of an earlier lease with Burris Oil and Chemical Company, also doing business as Basic Resources Company, from May 1979 to May 1983 (Reference K263; SR September 18, 1991).

Operations at this lease area have historically consisted of an asphalt emulsion batch plant for blending and packaging of a variety of asphalt emulsions for uses such as tack coat for highway construction and sealers for asphalt surfaces. The production process involves milling of asphalt cement with soap emulsifiers and other additions to produce asphalt emulsion products. The asphalt, emulsifiers, and asphalt emulsion are stored in above ground storage tanks (AGST) on a bermed area (Reference K358).

7.6.2 Results and Analysis of Activities

Activities at this asphalt emulsion plant have resulted in spills and releases of petroleum hydrocarbon related materials including heavy oils/tars (Reference K164, K359; SR September 18, 1991).

The building and adjacent areas have concrete pads in place for storage of drums, building access, and general operations. Much of the lease area is comprised of a soil

covered surface and a tour of the AGST area, drum storage area, and warehouse indicate that housekeeping practices could be improved. The tank farm area is bermed but does not have concrete secondary containments. The soil was observed visibly stained at several on-site locations including the area adjacent to the transfer loading valves (Reference SR, September 18, 1991).

The AGST area is diked and the lease facility surrounded by embankments to prevent storm water run-off from leaving the property. However, several of the storage tanks currently sit directly on the ground and not on concrete. There was evidence that constituents had been released to the surrounding surface soils (Reference K359; SR, September 18, 1991).

7.6.3 Potential or Known Releases or Environmental Impacts Related to Activity

The size and number of soil stains around the tanks indicate that a number of spills have taken place. A standing pool of liquid resembling oil and water was also observed near the northeast corner of the lease area approximately 30 feet northeast of several above ground storage tanks (Reference SR, September 18, 1991).

Review of August 2, 1979 aerial photography shows a large area of stained soil was present along the north side of the access road which services this lease area (Reference K164). The area to the north side of the access road appeared to have been disturbed by plowing or other heavy equipment activity (Reference SR, September 18, 1991).

Additionally, a review of KMCC records indicates that an oily sheen was observed in the Beta Ditch on June 29, 1983. The source of this oily substance was subsequently traced to the Koch Asphalt facility. An oily substance had overflowed and entered the storm sewer system. This oily substance resulted from: 1) an accumulation of contaminated water from chemical solution tanks, leakage, and washout of chemical tanks, and 2) an overflow of asphalt cement (approximately 600 gallons) during a tank to tank transfer (Reference K359).

This spill was promptly report by KMCC to the appropriate regulatory agencies. Koch Asphalt responded by cleaning up the spill from within the diked area and grounds;

excavating and capping of the storm drain to prevent future spills to the storm sewer; and initiating procedural changes at the facility. Although the spill was cleaned up, records were not found regarding assessment of possible remaining contamination to the site soils, storm sewer, or Beta Ditch (Reference K359).

7.7 Nevada Precast Concrete Products (KMCC Tenant)

7.7.1 History and Description of Activities

Nevada Precast Concrete Products utilized office space near the J.B. Kelley operations (Reference Plate 7-3) from January 1973 to May 1978. Only office activities are believed to have been conducted at this site (Reference K263, K357).

7.7.2 Results and Analysis of Activities

Kleinfelder did not find documentation or other information to suggest that activities other than routine office activities were conducted by Nevada Precast Concrete Products at this site.

7.7.3 Potential or Known Releases or Environmental Impacts Related to Activity

Kleinfelder did not find evidence of releases or environmental impact due to Nevada Precast Concrete Products activities at this site (Reference SR, September 18, 1991).

7.8 Green Ventures International (KMCC Tenant)

7.8.1 History and Description of Activities

Green Ventures International leased the S-3 changehouse (Reference Plate 7-3) for use as a marketing office for alfalfa sprouts which were grown by the Green farming operation. The lease term was from August 1980 to September 1981 (Reference K263, K357).

7.8.2 Results and Analysis of Activities

Kleinfelder did not find documentation or other information to suggest that activities other than routine office and marketing activities were conducted by Green Ventures International at this site.

7.8.3 Potential or Known Releases or Environmental Impacts Related to Activity

Kleinfelder did not find evidence of releases or environmental impact due to Green Ventures International activities at this site (Reference SR, September 18, 1991).

7.9 Buckles Construction Company (KMCC Tenant)

7.9.1 History and Description of Activities

Ben Buckles leased a portion of Unit 1 for the Buckles Construction Company (Reference Plate 7-3) from August 1973 to June 1989 (Reference K263). Activities, including steel fabrication and equipment storage, were based in the northwest corner on the first floor in the "crane bay", area of Unit 1 (Reference K263).

7.9.2 Results and Analysis of Activities

Kleinfelder did not find documentation or evidence of hazardous material storage, fuel transfer, painting or solvent use sometimes associated with steel fabrication activities. The lease area had been cleaned since tenant activities ceased (Reference SR, September 18, 1991).

7.9.3 Potential or Known Releases or Environmental Impacts Related to Activity

Kleinfelder did not find documentation, information or visual evidence of releases or environmental impacts due to Buckles Construction Company's use of a portion of Unit 1 (Reference SR, September 18, 1991).

7.10 Ebony Construction Company (KMCC Tenant)

7.10.1 History and Description of Activities

Ebony Construction Company leased a portion of the KMCC property in 1977 and 1978 for construction management and staging activities. Their activities were based on the first floor, center of the north side of Unit 1 (Reference Plate 7-3) with offices, storage space, and direct outside access (Reference K263, K357).

7.10.2 Results and Analysis of Activities

Kleinfelder did not find documentation or evidence of fuel dispensing, truck washing, hazardous material storage, equipment cleaning, or waste disposal activities within this

lease area that are sometimes associated with construction activities (Reference SR, September 9, 1991).

Two soil stains were present immediately north of Unit 1 and appear to be the result of motor oil or diesel fuel dripping from parked vehicles possibly associated with tenant activities (Reference K357; SR, September 9, 1991).

7.10.3 Potential or Known Releases or Environmental Impacts Related to Activity

The observed stained soil consists of two areas near the large garage door type openings in the center of the north wall of Unit 1. One stain appeared to encompass an area of approximately 10 feet by 10 feet and the second stain appeared to encompass an area of approximately two feet by 10 feet. Both stains are located approximately three to five feet north of the Unit 1 building (Reference SR, September 9, 1991).

7.11 Flintkote Company (KMCC Tenant)

7.11.1 History and Description of Activities

Flintkote Company leased an above ground diesel storage tank from KMCC starting July 1973 and lasting approximately 2 years. The tank was located near the southwest corner of the Chemstar facilities (Reference Plate 7-3; K263; K357).

Flintkote Company is one of the corporate names associated with predecessors of Chemstar (Reference K180).

7.11.2 Results and Analysis of Activities

Kleinfelder did not find documentation or other information to evaluate the type of activities related to this tank. The tank has been removed and the area has been disturbed by more recent activities (Reference SR, September 18, 1991).

7.11.3 Potential or Known Releases or Environmental Impacts Related to Activity

Kleinfelder did not find documentation, information, or visual evidence to suggest the presence or absence of environmental impacts (Reference SR, September 18, 1991).

7.12 Delbert Madsen and Estate of Delbert Madsen (KMCC Tenant)

7.12.1 History and Description of Activities

Delbert Madsen leased a triangular shaped 2 acre parcel at the northern most, eastern corner of the KMCC property (Reference Plate 7-4) with an address shown as 1627 Athol Street. The original lease term was from June 1976 to June 1989, when Mr. Madsen's heir (Lavern Vohs) assumed the lease which is still valid (Reference K263; K357).

The area is currently being used as a storage and salvage yard for 1940s vintage transportable government housing, used mobile homes, old vehicles and wrecked vehicles (Reference SR, September 18, 1991).

7.12.2 Results and Analysis of Activities

Business activities at the site appear to be idle. Stored items included numerous old buildings on blocks, numerous vehicles, automobile gas tanks, batteries, and 55-gallon drums. Refuse was observed scattered throughout the area (Reference SR, September 18, 1991).

7.12.3 Potential or Known Releases or Environmental Impacts Related to Activity

The originally intended business (house moving) conducted at this site may have included storage of building materials commonly used in the 1940s. Asbestos from building materials, including insulation and stucco, may be present (Reference SR, September 18, 1991).

7.13 Southern Nevada Auto Parts (SNAP) Area (KMCC Tenant)

7.13.1 History and Description of Activity

Southern Nevada Auto Parts (SNAP) and related companies are conducting businesses related to used automobiles in a northeastern portion of the KMCC property (Reference Plate 7-4). A variety of names and companies have been associated with operations on this 10 acre portion of KMCC property (Reference K263; SR September 18, 1991).

Robert and William Ellis leased this area beginning in October 1972 doing business as SNAP-TOW, Southern Nevada Auto Parts, and Pick-A-Part (Reference K263). Ed Smith and Vern Christensen have been shown as lease holders since January 1990, doing business as Nevada Recycling (an auto salvage yard) on the northern portions of this area (Reference K263). The following companies are currently operating on the property (Reference SR, September 18, 1991):

- o Southern Nevada Auto Parts, (an auto salvage yard);
- o SNAP-TOW, (a tow service and auto impound yard);
- o Pick-A-Part, (a do-it-yourself auto salvage yard); and
- o Nevada Recycling (an auto salvage yard).

7.13.2 Results and Analysis of Activity

Activities at the auto impound yard within the southern portion of this lease area consist of storage of wrecked, police impounded, and repossessed vehicles. Operations also included insurance adjustment assessment and auction of wrecked vehicles. Soil staining appeared to be minor in this area (Reference SR, September 18, 1991).

Activities at the auto salvage yard at the northern and western portions of this lease area included buyer dismantling and retrieval of parts. Activities in this area have resulted in spills and releases of various vehicle fluids which may include motor oil, gasoline, anti-freeze, and battery acids (Reference SR, September 18, 1991).

In the auto storage areas, most of the vehicles were elevated 1 to 3 feet high on blocks or wheel rims. This would make it possible to drain fluids. On the western most portion of this lease area, vehicles were placed directly on the ground, without benefit of blocking. (Reference SR, September 18, 1991).

7.13.3 Potential or Known Releases or Environmental Impacts Related to Activity

During a September 18, 1991 site reconnaissance, conversations with attendants of the auto salvage area revealed that routine practice is to drain gasoline from tanks for reuse by site based vehicles. Vehicle batteries are also removed and placed on pallets for pick-up by a recycler as part of routine practices. A number of batteries were observed on pallets, some of which appeared to have cracked cases (Reference SR, September 18, 1991).

An area of soil staining was observed near the office during the September 18, 1991, SR. This area appeared to be used for storage of mechanical components such as transmissions, engines and differentials. An adjacent area was being used for storage of radiators and also exhibited soil staining (Reference SR, September 18, 1991).

7.14 Dillon Potter (KMCC Tenant)

7.14.1 History and Description of Activities

Since July 1972, Dillon Potter has leased a 2 acre portion of KMCC property southeast of the SNAP-TOW lease area (Reference Plate 7-4; K263). This lease area is used to maintain a limited number of livestock including horses, pigs, cattle, chickens, and peacocks (Reference K263, UE102; SR, September 18, 1991). In addition, there were approximately 25 old vehicles along the fence line on the north side of the property (Reference SR, September 18, 1991).

7.14.2 Results and Analysis of Activities

Current activities at this site appear to be limited to livestock feeding. The storage of old vehicles appears to be incidental and unchanged for a number of years (Reference SR, September 18, 1991).

7.14.3 Potential or Known Releases or Environmental Impacts Related to Activity

Use of this lease area for the feeding of livestock is not expected to create significant environmental impact. Kleinfelder did not observe soil stains associated with stored vehicles during a September 18, 1991 SR.

I

der@environcorp.com, 29-Dec
18:18

CHAPTER 8.0
RECOMMENDATIONS

8.0 RECOMMENDATIONS

The following recommended actions are proposed by KMCC regarding the SWMUs (Chapter 5.0), known or suspected releases or spills (Chapter 6.0), and miscellaneous activities (Chapter 7.0) discussed in this report. KMCC makes these recommendations with the limitations noted in Section 2.4. Additional data or information may change the basis on which these recommendations are made. For convenience, the actions are summarized in Section 8.1. The reasons for the recommended action for each SWMU or each area are briefly discussed in Section 8.2.

8.1 Summary of Recommendations

<u>Recommended Action</u>	<u>Section</u>	<u>SWMU Number</u>	<u>SWMU Name</u>
NFS	5.1	KMCC-001	"Process Hardware" Storage Area Between Units 1 and 2
NFS	5.2	KMCC-002	Trash Storage Area North of Units 1 and 2
NFS	5.3	KMCC-003	PCB Storage Area - Unit 2
NFS	5.4	KMCC-004	Hazardous Waste Storage Area North of Unit 2
NFS	5.5	KMCC-005	Sodium Chlorate Filter Cake Holding Area No. of Unit 3
NFS	5.6	KMCC-006	Hazardous Waste Storage Area Between Units 3 and 4
NFS	5.7	KMCC-007	Platinum Drying Unit North of Unit 4
NFS	5.8	KMCC-008	Solid Waste Dumpsters
S	5.9	KMCC-009	Manganese Tailings Area

Legend:

- C = Clean Area/Improve Housekeeping
- S = Study
- NFS = No Further Study under the terms of this current agreement
- = Defer to BMI Common Area Report

<u>Recommended Action</u>	<u>Section</u>	<u>SWMU Number</u>	<u>SWMU Name</u>
NFS	5.29	KMCC-029	Satellite Accumulation Point - AP Maintenance Shop
NFS	5.30	KMCC-030	Storm Sewer System
NFS	5.31	KMCC-031	Acid Drain System

<u>Recommended Action</u>	<u>Section</u>	<u>Section Spill/Release Designation</u>
NFS	6.1	PCB Transformers
NFS	6.2	Unit 1 Tenants - Stains
NFS	6.3	Unit 2 Salt Redler
NFS	6.4	Unit 4 and Unit 5 Basements - Consent Agreement
NFS	6.5	Unit 6 Basements - Remediation Project
C	6.6	Diesel Storage Tank Area - Stains
NFS	6.7	Former Old Main Cooling Tower and Recirculation Lines
NFS	6.8	Leach Plant Area Manganese Ore Piles
S	6.9	Leach Plant Area Anolyte Tanks
S	6.10	Leach Plant Area Sulfuric Acid Storage Tank
S	6.11	Leach Plant Area Leach Tanks
S	6.12	Leach Plant Area Transfer Lines To/From Unit 6
NFS	6.13	AP Plant Area Screening Building, Dryer Building, and Associated Sump
NFS	6.14	AP Plant Area Tank Farm
S	6.15	AP Plant Area Change House/Laboratory Septic Tank
NFS	6.16	AP Plant Area Storage Pads - Fire
NFS	6.17	AP Plant Area Old Building D-1 - Wash Down

Legend:

C = Clean Area/Improve Housekeeping
 S = Study
 NFS = No Further Study under the terms of this current agreement
 --- = Defer to BMI Common Area Report

<u>Recommended Action</u>	<u>Section</u>	<u>Section Spill/Release Designation</u>
NFS	6.18	AP Plant Area New Building D-1 - Wash Down
NFS	6.19	AP Plant SIs and Transfer Lines to/From AP SIs
NFS	6.20	AP Plant Transfer Lines to Sodium Chlorate Process
---	7.1	BMI Common Area Disposal (Upper and Lower BMI Ponds)
---	7.2	BMI Common Area Disposal (BMI Landfill)
NFS	7.3	Old Sodium Chlorate Plant Decommissioning
S	7.4	State Industries, Inc. (KMCC Tenant)
C	7.5	J. B. Kelley, Inc. Trucking (KMCC Tenant)
C	7.6	Koch Materials Company (KMCC Tenant)
NFS	7.7	Nevada Precast Concrete Products (KMCC Tenant)
NFS	7.8	Green Ventures International (KMCC Tenant)
NFS	7.9	Buckles construction Company (KMCC Tenant)
NFS	7.10	Eboney Construction Company (KMCC Tenant)
NFS	7.11	Flintkote Company (KMCC Tenant)
C	7.12	Delbert Madsen & Estate of Delbert Madsen (KMCC Tenant)
C	7.13	Southern Nevada Auto Parts (SNAP) Area (KMCC Tenant)
NFS	7.14	Dillon Potter (KMCC Tenant)

Legend:

C = Clean Area/Improve Housekeeping

S = Study

NFS = No Further Study under the terms of this current agreement

--- = Defer to BMI Common Area Report

8.2 RECOMMENDATIONS

WASTE MANAGEMENT UNITS AND AREAS

5.1 "Process Hardware" Storage Area Between Units 1 and 2.....NFS

This SWMU is being operated in conformance with good operating practices in the industry. Further assessment of this SWMU is not recommended.

5.2 Trash Storage Area North of Units 1 and 2NFS

This SWMU is being operated in conformance with good operating practices in the industry. Further assessment of this SWMU is not recommended.

5.3 PCB Storage Area - Unit 2NFS

This SWMU is being operated in accordance with good operating practices and applicable requirements of 40 CFR, part 761 (Reference Doc. UE016; SR, August 19, 1981). Further assessment of this SWMU is not recommended.

5.4 Hazardous Waste Storage Area North of Unit 2.....NFS

Further assessment of this SWMU is not recommended. The small amount of oil stained soils observed near the south edge of this SWMU has been removed.

5.5 Sodium Chlorate Filter Cake Holding Area North of Unit 3NFS

Assessment of the current SWMU is not recommended. Materials associated with the previous drying pad have been properly disposed.

5.6 Hazardous Waste Storage Area Between Units 3 and 4NFS

The present good housekeeping practices reduce the potential for accumulation of the waste on the asphalt. Further assessment of this SWMU is not recommended.

5.7 Platinum Drying Unit North of Unit 4.....NFS

Operating practices have been revised to control the volume of material within this SWMU. The area has been cleaned. KMCC is installing a filtering process that will eliminate the platinum drying unit. Further assessment of this SWMU is not recommended.

5.8 Solid Waste Dumpsters.....NFS

This SWMU is being operated in conformance with good operating practices in the industry. Further assessment is not recommended.

- 5.9 Manganese Tailings Area S
 KMCC will sample this area to evaluate whether historic (pre-February 1975) manganese tailings management practices have impacted the area.
- 5.10 Old P-2 Surface Impoundment S
 KMCC will sample this SWMU as part of closure of the former pond site.
- 5.11 C-1 Surface Impoundment NFS
 This SWMU is being operated in conformance with good operating practices in the industry. Small pressure relief holes in the pipeline have been plugged. The pond has been scheduled to be removed from service as a part of KMCC's goal to eliminate non-essential facility ponds. Further assessment can be deferred until closure.
- 5.12 Mn-1 Surface Impoundment NFS
 This SWMU is being operated in conformance with good operating practices in the industry. Further assessment of this SWMU is not recommended.
- 5.13 Hazardous Waste Landfill (Closed) NFS
 This SWMU is currently under RCRA post-closure care and monitoring. An application for a permit for this SWMU has been on file with NDEP.
- 5.14 Trade Effluent Settling Ponds (U.S. Government Operations) S
 Additional data will be collected to evaluate the current status of the surface soil at the former pond site.
- 5.15 WC-1 (WC-West) Surface Impoundment NFS
 This SWMU is being operated in conformance with good operating practices in the industry. The construction plans for this newly built, double-lined pond were approved by NDEP. Further assessment of this SWMU is not recommended.
- 5.16 WC-2 (WC-East) Surface Impoundment NFS
 This SWMU is being operated in conformance with good operating practices in the industry. The construction plans for this newly built, triple-lined pond were approved by NDEP. Further assessment of this SWMU is not recommended.
- 5.17 Ammonium Perchlorate (AP) Area - Pad 35 NFS
 This SWMU is being operated in conformance with good operating practices in the industry. Housekeeping is being improved in this area. Further assessment is not recommended.
- 5.18 Drum Crushing Area NFS

This SWMU is being operated in conformance with good operating practices in the industry. Housekeeping in the area is being improved to reduce small spills. Further assessment of this SWMU is not recommended.

5.19 Groundwater Remediation Unit.....NFS

This SWMU is part of an ongoing Consent Agreement with NDEP for remediation of chromium contaminated groundwater. Housekeeping practices are being improved. Assessment of this unit can be managed under the existing Consent Agreement.

5.20 The Beta DitchS

Additional data will be collected as part of the common area evaluation.

5.21 Sodium Perchlorate Platinum By-Product Filter - Unit 5NFS

This SWMU is being operated in conformance with good operating practices in the industry. The containment area has been sealed to reduce minor leaks and housekeeping has been improved. Further assessment of this SWMU is not recommended.

5.22 Former Manganese Tailings AreaS

Sampling will be performed to evaluate whether historic tailings management practices impacted the area.

5.23 Closed Surface Impoundment S-1NFS

This SWMU has been certified Clean Closed by NDEP.

5.24 Closed Surface Impoundment P-1NFS

This SWMU has been certified Clean Closed by NDEP.

5.25 Truck Emptying/Dump SiteNFS

Small quantities of lime and soda ash materials have been blended with the existing soil and vehicular access to the area has been restricted. Further assessment of this SWMU is not recommended.

5.26 Former Satellite Accumulation Point - Unit 3, Maintenance ShopNFS

This SWMU is no longer in existence. Further assessment is not recommended.

5.27 Former Satellite Accumulation Point - Unit 6, Maintenance Shop NFS

This SWMU no longer exists. Further assessment is not recommended.

5.28 Satellite Accumulation Point, AP - Laboratory..... NFS

This SWMU is being operated in conformance with good operating practices and applicable requirements of 40 CFR 262.34. Further assessment is not recommended.

5.29 Satellite Accumulation Point, AP Maintenance Shop..... NFS

This SWMU is being operated in conformance with good operating practices and applicable requirements of 40 CFR 262.34. Further assessment is not recommended.

5.30 Storm Sewer System..... NFS

The storm sewers on KMCC property are monitored as a part of the KMCC NPDES permit.

5.31 Acid Drain System..... NFS

The acid drains on KMCC property are monitored as a part of the KMCC NPDES permit.

KNOWN OR SUSPECTED RELEASES OR SPILLS

6.1 PCB Transformers..... NFS

Further assessment of this spill is not necessary. Past response and clean-up actions were prompt, comprehensive, and responsible resulting in complete removal of contaminated concrete.

6.2 Unit 1 Tenants - Stains..... NFS

Cleanup of the area has been completed by removing the soils.

6.3 Unit 2 Salt Redler..... NFS

Further assessment of the Unit 2 Salt Redler is not recommended. Spills of solid sodium chloride are cleaned up promptly and housekeeping has been improved.

6.4 Unit 4 and Unit 5 Basements - Consent Agreement..... NFS

The existing 1986 Consent Order addresses remediation. Further assessment is not recommended.

- 6.5 Unit 6 Basements - Remediation Project NFS
 The existing 1986 Administrative Order addresses remediation. Further assessment is not recommended.
- 6.6 Diesel Storage Tanks Area - Stains.....C
 Areas of stained soil will be removed for off-site treatment/disposal and the underlying soil will be tested and remediated as required by NDEP. The tank has been taken out of service, the contents removed, and the interior cleaned.
- 6.7 Former Old Main Cooling Tower and Recirculation Lines NFS
 Assessment of impacts is not needed since primarily only naturally occurring dissolved salts are involved and constant discharge of high salt concentrations did not occur. Impact to groundwater by the small concentration of hexavalent chromium in the cooling tower water should be captured and treated by the KMCC groundwater remediation unit. Further assessment is not necessary as a separate assessment, since this will be addressed in conjunction with evaluation of the Beta Ditch.
- 6.8 Leach Plant Area Manganese Ore Piles..... NFS
 Manganese dioxide ore is a naturally occurring material which has a very low solubility in water. Further assessment of this area is not recommended.
- 6.9 Leach Plant Area Anolyte Tanks S
 KMCC will assess this area.
- 6.10 Leach Plant Area Sulfuric Acid Storage Tank S
 KMCC will assess this area.
- 6.11 Leach Plant Area Leach Tanks..... S
 KMCC will assess this area.
- 6.12 Leach Plant Area Transfer Lines To/From Unit 6 S
 KMCC will assess this area.
- 6.13 AP Plant Area Screening Building, Dryer Building, and Associated Sump NFS
 The area has been cleaned and both housekeeping and drainage have been improved. Further assessment is not necessary.

- 6.14 AP Plant Area Tank FarmNFS
 Area has been cleaned and housekeeping will be improved to address spills. Further assessment is not recommended.
- 6.15 AP Plant Area Change House/Lab Septic TankS
 The septic system receives only trace quantities of chemical from washwater, however KMCC will sample this area.
- 6.16 AP Plant Area Storage Pads - FireNFS
 This area was cleaned following the fire in July 1990 and further assessment is not recommended.
- 6.17 AP Plant Area Old Building D-1 - Wash DownNFS
 This area is no longer used but in the past appeared to be operated in conformance with good operating practices in the industry. Further assessment is not recommended.
- 6.18 AP Plant Area New Building D-1 - Wash DownNFS
 Further assessment of potential impacts from new D-1 building activities is not necessary due to the short period of operation and implementation of good operating practices.
- 6.19 AP Plant SIs and Transfer Lines To/From AP SIsNFS
 Further assessment of potential impacts from past releases from these transfer lines is not necessary because the releases are small. Evaluation of the SIs should be deferred until closure.
- 6.20 AP Plant Transfer Lines to Sodium Chlorate ProcessNFS
 Further assessment of potential impacts from the former releases of sodium hypochlorite from these transfer lines should not be necessary because the releases were small.

MISCELLANEOUS ACTIVITIES

- 7.1 BMI Common Area Disposal (Upper and Lower BMI Ponds)
 This area will be addressed in the Common Area Report.
- 7.2 BMI Common Area Disposal (BMI)
 This area will be addressed in the Common Area Report for this area.

- 7.3 Old Sodium Chlorate Plant Decommissioning NFS
The old sodium chlorate plant decommissioning was conducted by May 1992 under guidelines for RCRA waste where applicable. Further assessment is not recommended.
- 7.4 State Industries, Inc. (KMCC Tenant) S
Soil will be assessed in the former pond locations.
- 7.5 J. B. Kelley, Inc. Trucking (KMCC Tenant) C
KMCC will work with the tenant to improve housekeeping.
- 7.6 Koch Materials Company (KMCC Tenant) C
KMCC will work with the tenant to improve housekeeping.
- 7.7 Nevada Precast Concrete Products (KMCC Tenant)..... NFS
Further assessment of this area is not recommended.
- 7.8 Green Ventures International (KMCC Tenant) NFS
Further assessment of this area is not recommended.
- 7.9 Buckles Construction Company (KMCC Tenant) NFS
KMCC has cleaned this area. Further assessment of this area is not recommended.
- 7.10 Eboney Construction Company (KMCC Tenant) NFS
Further assessment of this area is not recommended.
- 7.11 Flintkote Company (KMCC Tenant) NFS
Further assessment of this area is not recommended.
- 7.12 Delbert Madsen & Estate of Delbert Madsen (KMCC Tenant) C
KMCC will work with the tenant to improve housekeeping.
- 7.13 Southern Nevada Auto Parts (SNAP) Area (KMCC Tenant)..... C
KMCC will work with the tenant to improve housekeeping.
- 7.14 Dillon Potter (KMCC Tenant) NFS
Further assessment of this area is not recommended.

I

der@environcorp.com, 29-Dec-18:18



*APPENDIX A
REFERENCES*



APPENDIX A

REFERENCES

Appendix A represents a list of references obtained from interviews and document searches from Kerr-McGee Chemical Corporation files and a variety of other sources.

For the purpose of internal record keeping and subsequent referencing, an alpha numeric code was assigned to each document. The alpha portion of the alpha numeric code corresponds to the source where the document was reviewed or obtained. The number portion of the code represents an arbitrary number assigned to the reference.

The following is a list of sources from which references were obtained or reviewed. The list denotes the source of the reference and the abbreviation used in the alpha portion of the alpha numeric code.

<u>Alpha Code</u>	<u>Reference Source</u>
K	Kerr-McGee
T	Timet
N	Nevada Colorado River Commission
ND	Nevada Division of Environmental Protection
CE	Clark County Health District - Environmental Health
CA	Clark County Health District - Air Pollution Control Division
UB	U.S. Bureau of Reclamation
UE	U.S. EPA Region IX
UN	University of Nevada Las Vegas - Environmental Research Center
NO	Nevada OSHA
GL	Gibson Library, Henderson, Nevada
GM	Geraghty & Miller, Inc.
UL	UNLV Library, Las Vegas, Nevada
OT	Other

The accompanying list reflects references cited throughout the report and is arranged alpha numerically.

APPENDIX A
REFERENCES

Rev.3.0
FINAL

REF.#: C001
DATE: 09/02/70
TO: Glen Taylor
COMPANY: Basic Management, Inc.
FROM: William H. Blackmer
COMPANY: Montgomery Engineers of Nevada
TITLE: Preliminary - "Basic Management, Inc., Lake Mead Pollution Study".

REF.#: C002
DATE: 03/18/76
TO: Alan Gaddy
COMPANY: KMCC
FROM: Starr Curtis
COMPANY: Chemstar Lime
TITLE: "B.M.I. Dumping Area, Solid Waste". Scale 1 inch equals 100 feet. Dated 3/18/76.

REF.#: CA001
DATE: 11/03/09
TO: Harold A. Bres
COMPANY: District Health Department
FROM: W. H. Voorheis
COMPANY: KMCC
TITLE: Letter notifying Dist. Air Pollution Control Board of intent to demolish building D-2.

REF.#: CA002
DATE: 01/12/79
TO: Charles Armstrong
COMPANY: KMCC
FROM: Harold A. Bres, Jr.
COMPANY: Clark County Health District
TITLE: List of emission points observed and for which operating permits exist presently or will be issued.

REF.#: CA017
DATE: 09/19/79
TO: Harold A. Bres
COMPANY: CCHD-APCD
FROM: R. F. Wohletz
COMPANY: KMCC
TITLE: Response to questions concerning production ratios and consumption of raw materials and certain other items.

REF.#: DR001
DATE: 04/00/72
TO:
COMPANY:
FROM: J.A. Westphal and W.E. Nork
COMPANY: Desert Research Institute
TITLE: "Reconnaissance Analysis of Effects of Waste-Water Discharge on The Shallow Ground-Water Flow System, Lower Las Vegas Valley, Nevada".

REF.#: DR002
DATE: 01/00/76
TO:
COMPANY: United States Bureau of Reclamation
FROM: Richard L. Bateman
COMPANY: Desert Research Institute
TITLE: "Analysis of Effects of Modified Waste-Water Disposal Practices on Lower Las Vegas Wash".

REF.#: DR003
DATE: 12/00/76
TO: Frederic Hoffman
COMPANY: EPA
FROM: Ralph O. Patt
COMPANY: Desert Research Institute
TITLE: "Las Vegas Valley Water Budget: Relationship of Distribution , Consumptive Use, and Recharge to Shallow Ground Water".

REF.#: DR004
DATE: 12/00/76
TO: Frederic Hoffman
COMPANY: EPA
FROM: Robert F. Kaufmann
COMPANY: Desert Research Institute
TITLE: "Land and Water Use Effects on Groundwater Quality in Las Vegas Valley".

REF.#: DR005
DATE: 03/00/80
TO:
COMPANY:
FROM: Alan Schmidt and John W. Hess
COMPANY: Desert Research Institute
TITLE: "Nitrogen and Phosphorus Hydrochemistry in Las Vegas Wash".

REF.#: DR006
DATE: 10/00/90
TO: Jane E. Denne
COMPANY: Environmental Monitoring Systems Laboratory
FROM: Karl F. Pohlmann and others
COMPANY: Desert Research Institute, Water Resource Center
TITLE: "Field Comparison of Ground-Water Sampling Devices For hazardous Waste Sites: An Evaluation Using Volatile Organic Compounds".

REF.#: DR007
DATE: 11/01/71
TO: Frederic Hoffman
COMPANY: EPA
FROM: Robert F. Kaufmann
COMPANY: Desert Research Institute
TITLE: Effects of Basic management Incorporated Effluent Disposal on the Hydrogeology and Water Quality of the Lower Las Vegas Wash Area, Las Vegas, Nevada.

REF.#: GL002
DATE: 04/21/47
TO: General Public
COMPANY:
FROM:
COMPANY: Gibson Library (Newspaper)
TITLE: "Basic Management Project Now 30 Percent Occupied".

REF.#: GM001
DATE: 10/20/44
TO:
COMPANY: U.S. Government
FROM: E.H. Clary
COMPANY: Basic Magnesium Inc.
TITLE: Plan view map of the Basic Magnesium Inc. Trade Effluent Disposal Ponds and surrounding area.

REF.#: GM002
DATE: 00/00/44
TO:
COMPANY: U.S. Government
FROM:
COMPANY: U.S. Government
TITLE: Cross section views (maps) for construction of various portions of the
trade effluent disposal ponds, Reference #N-35.

REF.#: GM003
DATE: 05/11/67
TO: General Public
COMPANY:
FROM:
COMPANY: Henderson Home News
TITLE: "BMI Digs Trenches For Waste Dump".

REF.#: GM004
DATE: 08/07/80
TO: General Public
COMPANY:
FROM:
COMPANY: Las Vegas Review-Journal
TITLE: Two articles, (1) "Chemical waste dump potentially hazardous"; and (2)
"HAZARDOUS".

REF.#: K003
DATE: 05/26/72
TO: R.L. O'Connell
COMPANY: USEPA
FROM: James J. Kelley
COMPANY: KMCC
TITLE: Reply to May 19, 1972 letter requesting information on Corporations plan
for compliance with the controlling water quality standards for effluent
discharge from the Henderson Plant.

REF.#: K013
DATE: 12/16/74
TO: R. L. O'Connell
COMPANY: USEPA
FROM: C.B. Armstrong
COMPANY: KMCC
TITLE: Project Completion Schedule.

REF.#: K017
DATE: 04/29/75
TO: Frank M. Covington
COMPANY: USEPA
FROM: C.B. Armstrong
COMPANY: KMCC
TITLE: Quarterly discharge report for period 1/1/75 through 3/31/75.

REF.#: K020
DATE: 10/24/75
TO: Gentlemen
COMPANY: NDEP
FROM: C.B. Armstrong
COMPANY: KMCC
TITLE: "NV0000078 Effective August 30, 1975".

REF.#: K022
DATE: 03/04/76
TO: Glen C. Taylor
COMPANY: Basic Management Incorporated
FROM: R.F. Wohletz
COMPANY: KMCC
TITLE: Quantity of solid waste disposed of in the BMI dump.

REF.#: K031
DATE: 03/22/79
TO: W. Marvin Tebeau
COMPANY: NDEP
FROM: C.B. Armstrong
COMPANY: KMCC
TITLE: Response to request of February 23, 1979 and listing of pond specifications.

REF.#: K032
DATE: 04/10/79
TO: Mr. Gregory
COMPANY: NDEP
FROM: C.B. Armstrong
COMPANY: KMCC
TITLE: Response to order dated March 27, 1979; discharge dates from pond C-1.

REF.#: K033
DATE: 05/03/79
TO: Don Detomasi
COMPANY: KMCC
FROM: E.S. Troscinski
COMPANY: Nalco Chemical Company
TITLE: Material Safety Data Sheets.

REF.#: K034
DATE: 01/03/80
TO: Marvin Tebeau
COMPANY: NDEP
FROM: R.F. Wohletz
COMPANY: KMCC
TITLE: Report on flow of 1 to 1.5 million gallons on non-hazardous material from cooling tower due to power failure.

REF.#: K037
DATE: 05/02/80
TO: Clyde B. Eller
COMPANY: USEPA
FROM: C.B. Armstrong
COMPANY: KMCC
TITLE: Background information on KMCC including ownership information, products produced, wastes produced, where wastes went, etc.

REF.#: K038
DATE: 05/14/80
TO: Marvin Tebeau
COMPANY: NDEP
FROM: R.F. Wohletz
COMPANY: KMCC
TITLE: Emergency discharge from cooling tower.

REF.#: K039
DATE: 07/18/80
TO: Clyde B. Eller
COMPANY: USEPA
FROM: C.B. Armstrong
COMPANY: KMCC
TITLE: Response to waste related operations and the solid and liquid waste produced by the operations.

REF.#: K046
DATE: 05/08/81
TO: Marvin Tebeau
COMPANY: NDEP
FROM: R.F. Wohletz
COMPANY: KMCC
TITLE: Request to start use of once-through cooling water earlier this year.

REF.#: K054
DATE: 02/01/82
TO:
COMPANY: NDEP
FROM: C.B. Armstrong
COMPANY: KMCC
TITLE: Discharge Monitoring Report.

REF.#: K055
DATE: 03/26/82
TO: Steve Pia
COMPANY: KMCC
FROM: Julian Bielawski
COMPANY: NDEP
TITLE: NPDES Compliance Inspection Report.

REF.#: K056
DATE: 03/31/82
TO: L. H. Dodgion
COMPANY: NDEP
FROM: C.B. Armstrong
COMPANY: KMCC
TITLE: Additional information answering questions in the Order of February 25, 1982. Also attachments of previous correspondence, applications and miscellaneous items.

REF.#: K057
DATE: 04/28/82
TO:
COMPANY: NDEP
FROM: C.B. Armstrong
COMPANY: KMCC
TITLE: Discharge Monitoring Report.

REF.#: K058
DATE: 05/14/82
TO: Bill Wilson
COMPANY: USEPA
FROM: C.B. Armstrong
COMPANY: KMCC
TITLE: First Quarter 1982 RCRA Groundwater Monitoring Data.

REF.#: K059
DATE: 05/21/82
TO: LaVerne Rosse
COMPANY: NDEP
FROM: C.B. Armstrong
COMPANY: KMCC
TITLE: Response to NDEP's Order.

REF.#: K060
DATE: 05/28/82
TO: Marvin Tebeau
COMPANY: NDEP
FROM: C.B. Armstrong
COMPANY: KMCC
TITLE: Pond Leak Detection Program.

REF.#: K061
DATE: 06/04/82
TO: L. H. Dodgion
COMPANY: NDEP
FROM: C.B. Armstrong
COMPANY: KMCC
TITLE: Estimated water balance for KMCC (1981).

REF.#: K062
DATE: 07/14/82
TO: William D. Wilson
COMPANY: USEPA
FROM: C.B. Armstrong
COMPANY: KMCC
TITLE: Revised Part A Permit Application.

REF.#: K063
DATE: 07/14/82
TO: William D. Wilson
COMPANY: USEPA
FROM: C.B. Armstrong
COMPANY: KMCC
TITLE: Revised Part A Application. This is a repeat of document number K062.
Note that K063 has one more page included in the Part A Permit Application
that is attached.

REF.#: K064
DATE: 07/29/82
TO: Marvin Tebeau
COMPANY: NDEP
FROM: C.B. Armstrong
COMPANY: KMCC
TITLE: Quarterly Discharge Monitoring Report.

REF.#: K065
DATE: 08/17/82
TO: Marvin Tebeau
COMPANY: NDEP
FROM: C.B. Armstrong
COMPANY: KMCC
TITLE: Response about Pond Monitoring System. Pond AP-2 leaked in 1979.

REF.#: K066
DATE: 08/17/82
TO: Bill Wilson
COMPANY: USEPA
FROM: C.B. Armstrong
COMPANY: KMCC
TITLE: Second Quarter 1982 RCRA Groundwater Monitoring Data.

REF.#: K068
DATE: 10/26/82
TO: Bill Wilson
COMPANY: USEPA
FROM: C.B. Armstrong
COMPANY: KMCC
TITLE: Second Quarter 1982 RCRA Groundwater Monitoring Data.

REF.#: K069
DATE: 10/27/82
TO: Marvin Tebeau
COMPANY: NDEP
FROM: R.B. Chase
COMPANY: KMCC
TITLE: Quarterly Discharge Monitoring Report.

REF.#: K070
DATE: 01/03/83
TO: Inter office memo
COMPANY: KMCC
FROM: J.C. Stautner
COMPANY: KMCC
TITLE: RCRA Groundwater Monitoring Requirements, 1983.

REF.#: K070A
DATE: 01/20/83
TO: Harry Van Drielen
COMPANY: NDEP
FROM: R.B. Chase
COMPANY: KMCC
TITLE: January 16, 1983 reportable spill.

REF.#: K071
DATE: 01/21/83
TO: LaVerne Rosse
COMPANY: NDEP
FROM: R.B. Chase
COMPANY: KMCC
TITLE: Closure Plan for Hazardous Waste Landfill.

REF.#: K077
DATE: 02/24/83
TO: Bill Wilson
COMPANY: USEPA
FROM: R.B. Chase
COMPANY: KMCC
TITLE: Third quarter 1982 RCRA ground water monitoring data.

REF.#: K079
DATE: 06/00/82
TO: Unknown
COMPANY: KMCC
FROM: Unknown
COMPANY: KMCC
TITLE: Explanation of Geological and Well Construction Data, KMCC RCRA Interim Status Groundwater Monitoring Program.

REF.#: K083
DATE: 06/09/83
TO: Bill Wilson
COMPANY: USEPA
FROM: R.B. Chase
COMPANY: KMCC
TITLE: P-1 closure/post-closure plan.

REF.#: K084
DATE: 07/01/83
TO: Unknown
COMPANY: KMCC
FROM: Unknown
COMPANY: KMCC
TITLE: Update on Ground Water Assessment.

REF.#: K091
DATE: 02/01/84
TO: H. LaVerne Rosse
COMPANY: NDEP
FROM: R.B. Chase
COMPANY: KMCC
TITLE: Groundwater Monitoring. Traced chrome contamination to basements of Units 4 and 5.

REF.#: K092
DATE: 03/07/84
TO: H. LaVerne Rosse
COMPANY: NDEP
FROM: R.B. Chase
COMPANY: KMCC
TITLE: RCRA groundwater monitoring results; logs and construction details; and a response to a letter regarding repairs in the basements of Units 4 and 5.

REF.#: K095
DATE: 04/05/84
TO: H. LaVerne Rosse
COMPANY: NDEP
FROM: R.B. Chase
COMPANY: KMCC
TITLE: Revised Closure and Post-Closure Plans For Surface Impoundments S-1 and P-1.

REF.#: K104
DATE: 07/13/84
TO: Thomas J. Fronapfel
COMPANY: NDEP
FROM: R.B. Chase
COMPANY: KMCC
TITLE: Additional samples of the chlorate storage site located in the basement of Unit 6.

REF.#: K104A
DATE: 08/02/84
TO: NDEP file
COMPANY: KMCC
FROM: F.R. Stater
COMPANY: KMCC
TITLE: July 31, 1984 reportable sulfuric acid spill.

REF.#: K105
DATE: 09/26/84
TO: Thomas J. Fronapfel
COMPANY: NDEP
FROM: R.B. Chase
COMPANY: KMCC
TITLE: Closure/Post-Closure Plan for P-1 and S-1.

REF.#: K106
DATE: 10/04/84
TO: LaVerne Rosse
COMPANY: NDEP
FROM: R.B. Chase
COMPANY: KMCC
TITLE: RCRA Ground Water Monitoring.

REF.#: K108
DATE: 10/25/84
TO: H. LaVerne Rosse
COMPANY: NDEP
FROM: R.B. Chase
COMPANY: KMCC
TITLE: Revision of closure/post-closure plan for hazardous waste landfill.

REF.#: K111
DATE: 03/07/85
TO: Thomas J. Fronapfel
COMPANY: NDEP
FROM: R.F. Stater
COMPANY: KMCC
TITLE: Requesting written approval to use the "non-hazardous" waste disposal site on KMCC's Henderson Facility for disposal of manganese tails and other debris and building rubble from demolition.

REF.#: K112
DATE: 04/16/85
TO: R.B. Chase
COMPANY: KMCC
FROM: Tom Fronapfel
COMPANY: NDEP
TITLE: No comments received during public comment period, closure activities for the landfill may begin.

REF.#: K117
DATE: 07/01/85
TO: Joe Livak
COMPANY: NDEP
FROM: R.B. Chase
COMPANY: KMCC
TITLE: Additional information about KMCC's operations for rewrite of KMCC NPDES

Permit.

REF.#: K123
DATE: 09/04/85
TO: Thomas J. Fronapfel
COMPANY: NDEP
FROM: R.B. Chase
COMPANY: KMCC
TITLE: Letter documenting activities for closure of surface impoundment S-1.

REF.#: K124
DATE: 09/06/85
TO: Tom Fronapfel
COMPANY: NDEP
FROM: R.B. Chase
COMPANY: NDEP
TITLE: Letter documenting activities for closure of surface impoundment P-1.

REF.#: K126
DATE: 10/21/85
TO: P.S. Corbett
COMPANY: KMCC
FROM: Fronapfel
COMPANY: NDEP
TITLE: One week extension for certificate of closure of hazardous waste landfill.

REF.#: K126A
DATE: 10/21/85
TO: LaVerne Rosse
COMPANY: NDEP
FROM: P.S. Corbett
COMPANY: KMCC
TITLE: RCRA ground water monitoring results from samples collected on July 5, 1985.

REF.#: K128
DATE: 10/22/85
TO: Tom Fronapfel
COMPANY: NDEP
FROM: P.S. Corbett
COMPANY: KMCC
TITLE: Completed closure of hazardous waste landfill. Kleinfelder report of activities and closure/post-closure plan.

REF.#: K130
DATE: 11/20/85
TO: Phillip Bobel
COMPANY: USEPA
FROM: R.B. Chase
COMPANY: KMCC
TITLE: Response to information requests. Part B application submittal.

REF.#: K131
DATE: 12/05/85
TO: R.B. Chase
COMPANY: KMCC
FROM: Tom Fronapfel
COMPANY: NDEP
TITLE: SIs S-1 and P-1 closed in accordance with closure plan. The landfill was not closed in accordance with closure plan.

REF.#: K137
DATE: 12/31/85
TO: Joe Livak
COMPANY: NDEP
FROM: R.B. Chase
COMPANY: KMCC
TITLE: "NPDES Quarterly Monitoring Report, Permit NV 0000078".

REF.#: K138
DATE: 01/17/86
TO: P.S. Corbett
COMPANY: KMCC
FROM: Tom Fronapfel
COMPANY: NDEP
TITLE: Hazardous Waste Landfill closed in accordance with closure plan.

REF.#: K140A
DATE: 02/26/86
TO: LaVerne Rosse
COMPANY: NDEP
FROM: R.B. Chase
COMPANY: KMCC
TITLE: February 25, 1986 reportable analyte spill.

REF.#: K142
DATE: 04/02/86
TO: B. Hoffman
COMPANY: KMCC
FROM: S.M. Crowley
COMPANY: KMCC
TITLE: Information on hazardous waste landfill (from closure/post-closure plan) to prepare a recordable document (plat).

REF.#: K146A
DATE: 06/10/86
TO: Mr. Dodgion
COMPANY: NDEP
FROM: R.B. Chase
COMPANY: KMCC
TITLE: Plans and schedule for the elimination of the subject surface discharges from the cooling tower.

REF.#: K146B
DATE: 06/11/86
TO: LaVerne Rosse
COMPANY: NDEP
FROM: R.B. Chase
COMPANY: KMCC
TITLE: RCRA Ground Water Monitoring Results from samples collected on January 2 and 21, 1986.

REF.#: K146C
DATE: 09/16/86
TO: Mr. Chase
COMPANY: KMCC
FROM:
COMPANY: NDEP
TITLE: Order and Finding. Unit 6 Discharge Mitigation.

REF.#: K147
DATE: 09/29/86
TO: Harry Seraydarian
COMPANY: USEPA
FROM: R.B. Chase
COMPANY: KMCC
TITLE: Information regarding potential releases from solid waste management units.

REF.#: K153
DATE: 06/08/87
TO: LaVerne Rosse
COMPANY: NDEP
FROM: P.S. Corbett
COMPANY: KMCC
TITLE: RCRA Ground Water Monitoring results of samples collected on January 7, 1987.

REF.#: K155
DATE: 02/25/88
TO: LaVerne Rosse
COMPANY: NDEP
FROM: P.S. Corbett
COMPANY: KMCC
TITLE: RCRA Ground Water Monitoring Results from samples collected in January, 1988.

REF.#: K158
DATE: 08/11/89
TO: LaVerne Rosse
COMPANY: NDEP
FROM: P.S. Corbett
COMPANY: KMCC
TITLE: RCRA ground water monitoring results from samples collected on 6/22/89.

REF.#: K158A
DATE: 07/18/90
TO: Alan Gaddy
COMPANY: KMCC
FROM: Kent R. Neddenriep
COMPANY: KMCC
TITLE: June 8, 1988 Permit to Discharge and July 18, 1990 Leak Detection Plan approval.

REF.#: K158B
DATE: 07/18/90
TO: Gentlemen
COMPANY: National Response Center
FROM: F.R. Stater
COMPANY: KMCC
TITLE: July 12, 1990 reportable spill. Fire in AP production area.

REF.#: K160
DATE: 12/21/42
TO:
COMPANY: U.S. Government
FROM: W.B. Dyer
COMPANY: Basic Magnesium Inc.
TITLE: Sanitary Sewer Map.

REF.#: K161
DATE: 07/03/87
TO:
COMPANY: KMCC
FROM: Vern W. Cartwright (Photogrammetric Surveyor #82)
COMPANY:
TITLE: Topographic map of KMCC. Scale equals 1" = 200'.

REF.#: K163
DATE: 00/00/42
TO:
COMPANY: U.S. Government
FROM:
COMPANY: Basic Magnesium Inc.
TITLE: Acid Drain Map.

REF.#: K164
DATE: 07/00/80
TO:
COMPANY: USEPA
FROM:
COMPANY: Environmental Monitoring Systems Lab (EMSL-LV)
TITLE: "Aerial Surveys of Hazardous Waste Disposal, Point and Nonpoint Source Pollution Features Within and Adjacent to BMI Complex". Additionally, "Development of Hazardous Waste Disposal, Point, and Nonpoint Source (NPS)

Pollution Features Within and Adjacent to the BMI Complex From 1943 to 1979".

REF.#: K165
DATE: 03/11/82
TO:
COMPANY: KMCC
FROM: Andrew S. McCreath & Son, Inc.
COMPANY: Compagnie Miniere de l'Ogooue
TITLE: Manganese ore analyses.

REF.#: K167
DATE: 07/00/85
TO: R.B. Chase
COMPANY: KMCC
FROM: Bert J. Smith
COMPANY: KMCC
TITLE: Hydrogeological Investigation, KMCC - Henderson Facility.

REF.#: K168
DATE: 07/09/85
TO:
COMPANY: USEPA
FROM:
COMPANY: KMCC
TITLE: July 6, 1985 analyte leak from storage tank.

REF.#: K169
DATE: 07/18/85
TO:
COMPANY: NDEP
FROM: R.B. Chase
COMPANY: KMCC
TITLE: RCRA ground water monitoring results.

REF.#: K170
DATE: 10/09/87
TO:
COMPANY: USEPA
FROM:
COMPANY: Jacobs Engineering
TITLE: Draft RCRA Facility Assessment of KMCC.

REF.#: K171
DATE: 11/11/88
TO:
COMPANY: KMCC
FROM:
COMPANY: State Industries
TITLE: EP Toxicity results on the solar evaporation pond at State Industries.

REF.#: K172
DATE: 04/27/89
TO: In-House
COMPANY: KMCC
FROM:
COMPANY: KMCC
TITLE: April 27, 1989 anolyte leak from a storage tank.

REF.#: K173
DATE: 09/01/73
TO:
COMPANY: KMCC
FROM:
COMPANY: KMCC
TITLE: September 1, 1989 anolyte leak from LIA tank.

REF.#: K174
DATE: 04/25/91
TO: Patrick S. Corbett
COMPANY: KMCC
FROM:
COMPANY: NDEP
TITLE: Consent Agreement. Phase I Environmental Conditions Assessment (Phase I ECA).

REF.#: K176
DATE: 01/10/91
TO: P.S. Corbett
COMPANY: KMCC
FROM: D.G. Elmer
COMPANY: KMCC
TITLE: Internal Correspondence - Breakdown of production and sales from 1951 through 1990.

REF.#: K178
DATE: 00/00/44
TO:
COMPANY: U.S. Government
FROM:
COMPANY: Basic Magnesium Inc.
TITLE: Storm Drain Map.

REF.#: K179
DATE: 03/15/90
TO: Paul La Courreye
COMPANY: USEPA
FROM: Peter R. Towle
COMPANY: Ecology and Environment, Inc.
TITLE: CERCLA Screening Site Inspection of KMCC, Henderson, Nevada.

REF.#: K180
DATE: 07/24/91
TO: Lorraine Bruce
COMPANY: Geraghty and Miller, Inc.
FROM: H. Starr Davis
COMPANY: Chemstar Lime
TITLE: Corporate names associated with Chemstar Lime's plant in the BMI Complex, Henderson, Nevada.

REF.#: K181
DATE: 06/28/91
TO:
COMPANY: KMCC
FROM:
COMPANY: Kleinfelder, Inc.
TITLE: Revised Work Plan for Preparation of a Phase I Environmental Conditions

Assessment of the Kerr-McGee Facility (BMI Complex), Henderson, Nevada.

REF.#: K182
DATE: 07/09/91
TO: P.S. Corbett
COMPANY: KMCC
FROM:
COMPANY: NDEP
TITLE: Approval of Revised Draft Work Plan for Phase I Environmental Conditions Assessment of the KMCC facility.

REF.#: K210
DATE: 11/08/83
TO: W. L. Johnson
COMPANY: KMCC
FROM: P. S. Corbett
COMPANY: KMCC
TITLE: Application for Expenditure - Replace Pond AP-1 and AP-3.

REF.#: K212
DATE: 08/06/84
TO: J. L. Rainey
COMPANY: KMCC
FROM: R. J. Vreeland
COMPANY: KMCC
TITLE: Application for Expenditure - new cooling tower for the ammonium perchlorate plant to provide cooling for the salt crystallizer.

REF.#: K214
DATE: 12/08/89
TO:
COMPANY: KMCC
FROM:
COMPANY: Tracker Services, Inc.
TITLE: Daily Operational Summary - De-watering A.P. Pond.

REF.#: K219
DATE: 03/23/82
TO:
COMPANY: KMCC
FROM:
COMPANY: KMCC
TITLE: Application for Authorization for equipment which will provide for treatment of solid waste (Filter Cake) generated in the sodium chlorate recovery area, thereby rendering it "non-Hazardous" by EPA Standards.

REF.#: K220
DATE: 04/10/90
TO: W. F. Marseilles
COMPANY: KMCC
FROM: P. S. Corbett
COMPANY: KMCC
TITLE: Decommissioning Sodium Chlorate Pond P-2.

REF.#: K223
DATE: 08/30/84
TO: W. L. Johnson
COMPANY: KMCC
FROM: R. E. Huggins
COMPANY: KMCC
TITLE: Application For Expenditure - Reline Pond P-2.

REF.#: K249
DATE: 01/19/87
TO: W. F. Marseilles
COMPANY: KMCC
FROM: P. S. Corbett
COMPANY: KMCC
TITLE: Installation of Process spill Containment System in Unit 6 of the manganese dioxide plant.

REF.#: K253
DATE: 00/00/66
TO:
COMPANY: AP & CC
FROM:
COMPANY: AP & CC
TITLE: Henderson Plant Process General Description.

REF.#: K255
DATE: 07/01/75
TO: James A. Maston - Donald R. Arkell
COMPANY: Air Pollution Control Division
FROM: C. B. Armstrong
COMPANY: KMCC
TITLE: Registration/Application for Operating Permit for magnesium perchlorate manufacture.

REF.#: K256
DATE: 09/19/84
TO:
COMPANY: KMCC
FROM:
COMPANY: KMCC
TITLE: Tumbleleaf Defoliant.

REF.#: K257
DATE: 10/08/85
TO: R. F. Wohletz
COMPANY: KMCC
FROM: S. T. George
COMPANY: KMCC
TITLE: The production of Boron Trichloride.

REF.#: K258
DATE: 02/00/86
TO:
COMPANY: KMCC
FROM:
COMPANY: KMCC
TITLE: The production of Boron at KMCC, Henderson.

REF.#: K259
DATE: 06/00/91
TO:
COMPANY: KMCC
FROM:
COMPANY: KMCC
TITLE: Sodium Chlorate Process Flow Diagrams.

REF.#: K260
DATE: 02/20/91
TO: Dan Gross
COMPANY: NDEP
FROM: P. S. Corbett
COMPANY: KMCC
TITLE: 1990 PCB Inspection Data Sheets

REF.#: K261
DATE: 11/07/82
TO: Distribution
COMPANY: KMCC
FROM: J. H. Stallings
COMPANY: KMCC
TITLE: PCB's - use in electrical equipment - amendments to existing rules.

REF.#: K262
DATE: 02/22/91
TO:
COMPANY: Clark County Recorders Office
FROM:
COMPANY: AP & CC
TITLE: Rights of Way and Easements and Summary of Property Conveyances.

REF.#: K263
DATE: 08/28/91
TO:
COMPANY:
FROM: Alan Gaddy
COMPANY: KMCC
TITLE: "Henderson, Nevada Leases".

REF.#: K264
DATE: 05/02/90
TO: Alan Gaddy
COMPANY: KMCC
FROM: Brent E. Stephens
COMPANY: Data Chem Laboratories
TITLE: EP Toxicity results of manganese tailings.

REF.#: K265
DATE: 06/28/71
TO: FILE
COMPANY: KMCC
FROM: R.F. Wohletz
COMPANY: KMCC
TITLE: Narrative on plant effluents.

REF.#: K266
DATE: 06/00/71
TO:
COMPANY: Department of the Army, Corps of Engineers
FROM: T.L. Hurst
COMPANY: KMCC
TITLE: "Application for permit to discharge or work in navigable waters and their tributaries".

REF.#: K268
DATE: 04/12/83
TO: Stephen H. Pia
COMPANY: KMCC
FROM: Gary Meke
COMPANY: U.S. Ecology
TITLE: "Chemical Waste Shipment Record Form, Straight Bill of Lading".

REF.#: K269
DATE: 00/00/75
TO:
COMPANY:
FROM:
COMPANY: KMCC
TITLE: Manganese dioxide plant - process flow diagram.

REF.#: K275
DATE: 06/09/70
TO: H.S. Curtis
COMPANY: AP & CC
FROM: J.E. Reynolds
COMPANY: AP & CC
TITLE: Inventory of air and water effluents (Pollution Inventory).

REF.#: K277
DATE: 03/09/70
TO: H.S. Curtis
COMPANY: AP & CC
FROM: R.F. Wohletz
COMPANY: AP & CC
TITLE: "Sources of Water Pollution From Chlorate Plant".

REF.#: K278
DATE: 03/06/70
TO: H.S. Curtis
COMPANY: AP & CC
FROM: J.E. Reynolds
COMPANY: AP & CC
TITLE: "Water Pollution Abatement Program".

REF.#: K281
DATE: 05/19/81
TO: Curtis Tidwell and Lee Span
COMPANY: State Industries
FROM: Randy Marcus and Gary Lavagnino
COMPANY: NDEP
TITLE: "EPA Region IX Facility Investigation Report".

REF.#: K282
DATE: 11/14/85
TO: Leonard Spann
COMPANY: State Industries
FROM: Alene Coulson
COMPANY: NDEP
TITLE: "Interim Status Standards (ISS), Treatment, Storage, or Disposal Facility, investigation Report, NAC 444.8850".

REF.#: K283
DATE: 01/15/87
TO: Alene Coulson
COMPANY: NDEP
FROM: Leonard Spann
COMPANY: State Industries.
TITLE: "NDEP Small Quantity Generator Investigation Report, (100-1000 Kg)".

REF.#: K286
DATE: 01/31/89
TO: Joe Livak
COMPANY: NDEP
FROM: Dave Chesmore
COMPANY:
TITLE: Record of Communication "Waste Water Pond Closure, State Industries, L.V."

REF.#: K289
DATE: 08/14/80
TO: Curtis Tidwell
COMPANY: State Industries
FROM: A. Han
COMPANY: State Industries
TITLE: Inter office correspondence - Hazardous waste compliance.

REF.#: K290
DATE: 11/03/80
TO: Bill Wilson
COMPANY: USEPA
FROM: Leonard Spann
COMPANY: State Industries
TITLE: Request to be removed as "treaters" of hazardous waste.

REF.#: K295
DATE: 06/14/73
TO: Glen Taylor
COMPANY: Basic Management Inc.
FROM: R.T. Whitney
COMPANY: Public Works
TITLE: Industrial waste discharges into the sewer system (City Plant No. 2).

REF.#: K297
DATE: 06/13/73
TO: Whitney
COMPANY: Public Works
FROM: Henry J. Greenville
COMPANY: USPHS (Ret), consulting, Sanitary and Biochemical Engineer
TITLE: Two separate discharges of industrial chemical waste occurred.

Unable to open <https://datasite.merrillcorp.com/bidder/servlet/tiff/800101187-369.jpg?projectId=34435&pageNumber=369&versionId=800101187&username=username&format=bw&enc=enc>.

Error: java.io.IOException:

Server returned HTTP response code: 500 for URL: https://datasite.merrillcorp.com/bidder/servlet/tiff/800101187-369.jpg?projectId=34435&pageNumber=369&versionId=800101187&username=username&format=bw&enc=enc

Error: Please make sure this file can be accessed and that it is a supported file type.

REF.#: K304
DATE: 09/09/86
TO: LaVerne Rosse
COMPANY: NDEP
FROM: Susan M. Crowley
COMPANY: KMCC
TITLE: Letter transmitting signed finalized Consent Order for clean-up of chromium in ground water at the Henderson Facility. (September 9, 1986 Consent Order - Chromium contaminated Ground Water Mitigation.)

REF.#: K305
DATE: 01/24/91
TO: Joe Livak
COMPANY: NDEP
FROM: Patrick S. Corbett
COMPANY: KMCC
TITLE: "NDEP December 1990 Discharge Monitoring Report (DMR) - NPDES Permit No. NV0000078".

REF.#: K318
DATE: 03/09/90
TO: Brent E. Stephens
COMPANY: Data Chem Laboratories
FROM: Alan J. Gaddy
COMPANY: KMCC
TITLE: "Analytical Request Form" requesting analyses of iron oxide solids (Fe2O3) from ground water treatment unit and analytical results.

REF.#: K319
DATE: 06/05/90
TO: Alan J. Gaddy
COMPANY: KMCC
FROM: Brent E. Stephens
COMPANY: Data Chem Laboratories
TITLE: Analytical results - TCLP (8 metals) analyses for 1990 manganese tailings.

REF.#: K320
DATE: 01/19/90
TO: Joe Livak
COMPANY: NDEP
FROM: Patrick S. Corbett
COMPANY: KMCC
TITLE: "NDEP December 1989 Discharge Monitoring Report, NPDES #NV0000078".

REF.#: K321
DATE: 12/03/90
TO: Jim Robinson
COMPANY: National Response Center
FROM: P.S. Corbett
COMPANY: KMCC
TITLE: "Spill Report #48954 - PCB Spill to Containment Area".

REF.#: K322
DATE: 10/19/79
TO: Juris Kanasezics
COMPANY: Atlas Foundry and Manufacturing Company
FROM: W.H. Voorheis
COMPANY: KMCC
TITLE: Cover letter and bill of lading for a carload of scrap graphite.

REF.#: K323
DATE: 11/15/78
TO: Juris Kanasezics
COMPANY: Atlas Foundry and Manufacturing Company
FROM: W.H. Voorheis
COMPANY: KMCC
TITLE: Cover letter and bill of lading for a carload of scrap graphite.

REF.#: K324
DATE: 04/14/76
TO: Juris Kanasezics
COMPANY: Atlas Foundry and Manufacturing Company
FROM: W.H. Voorheis
COMPANY: KMCC
TITLE: Cover letter and bill of lading for a carload of scrap graphite.

REF.#: K325
DATE: 11/03/81
TO: Tom Ireland
COMPANY: KMCC
FROM: W.H. Voorheis
COMPANY: KMCC
TITLE: Internal Correspondence - Shipping document and weight ticket covering a load of scrap carbon (chlorate) sold to Stan Brand Inc.

REF.#: K326
DATE: 11/26/85
TO: Joe Livak
COMPANY: NDEP
FROM: R.B. Chase, Jr.
COMPANY: KMCC
TITLE: "NPDES Permit NV 000078". Discharge of cooling tower water to Beta ditch.

REF.#: K327
DATE: 12/27/85
TO: Joe Livak
COMPANY: NDEP
FROM: P.S. Corbett
COMPANY: KMCC
TITLE: "NPDES Permit NV 000078". Cooling tower water discharge to the Beta ditch.

REF.#: K328
DATE: 12/13/85
TO: Joe Livak
COMPANY: NDEP
FROM: P.S. Corbett
COMPANY: KMCC
TITLE: Deleted, was second page to doc. #K327.

REF.#: K329
DATE: 12/30/85
TO: Joe Livak
COMPANY: NDEP
FROM: R.B. Chase, Jr.
COMPANY: KMCC
TITLE: "NPDES Permit NV 000078". Cooling tower water discharge to the Beta ditch.

REF.#: K330
DATE: 01/06/86
TO: Joe Livak
COMPANY: NDEP
FROM: P.S. Corbett
COMPANY: KMCC
TITLE: "NPDES Permit NV 000078". Discharge of cooling tower water into the Beta ditch.

REF.#: K331
DATE: 02/20/86
TO: Joe Livak
COMPANY: NDEP
FROM: R.B. Chase, Jr.
COMPANY: KMCC
TITLE: "NPDES Permit NV 0000078". Cooling tower water discharge into the Beta ditch.

REF.#: K332
DATE: 03/31/86
TO: Susan Crowley
COMPANY: KMCC
FROM: Mark Small
COMPANY: Timet
TITLE: Summary of search for cause of high return to KMCC's cooling tower.

REF.#: K333
DATE: 01/06/86
TO: Susan Crowley
COMPANY: KMCC
FROM: Mark Small
COMPANY: Timet
TITLE: Report on 12/10/85, recirculated water line failure (cooling tower overflow).

REF.#: K334
DATE: 10/23/89
TO: W.M. Claeys
COMPANY: KMCC
FROM: K.A. Cimaglia
COMPANY: KMCC
TITLE: "Plant Water Balance, September, 1989".

REF.#: K335
DATE: 00/00/91
TO:
COMPANY: KMCC
FROM:
COMPANY: KMCC
TITLE: Listing of "dead files" where platinum shipment accounting information is stored.

REF.#: K336
DATE: 03/26/91
TO: Tom Ryan
COMPANY: PGP Industries
FROM:
COMPANY: KMCC
TITLE: "Material Shipping Order" for filter cake containing platinum from the sodium perchlorate process.

REF.#: K337
DATE: 04/01/91
TO:
COMPANY: PGP Industries, Inc.
FROM: Alan J. Gaddy
COMPANY: KMCC
TITLE: "Uniform Hazardous Waste Manifest".

REF.#: K338
DATE: 00/00/91
TO:
COMPANY: KMCC
FROM:
COMPANY: KMCC
TITLE: "Draft Steam Plant Training Manual"

REF.#: K339
DATE: 10/23/89
TO: Larry G. Christiansen
COMPANY: KMCC
FROM:
COMPANY: Espy Brothers Construction
TITLE: Contract and invoices for old main cooling tower demolition.

REF.#: K340
DATE: 08/16/91
TO: Larry G. Christiansen
COMPANY: KMCC
FROM:
COMPANY: Centennial Concrete
TITLE: Invoice for concrete removal from basement of Sub 50.

REF.#: K341
DATE: 08/28/91
TO: Larry G. Christiansen
COMPANY: KMCC
FROM:
COMPANY: Centennial Concrete
TITLE: Invoice for concrete removal from basement of Sub 50.

REF.#: K342
DATE: 11/23/88
TO:
COMPANY: KMCC
FROM: Lewis Dickson
COMPANY: Gundle
TITLE: "Pipe Test Certificate" for transfer piping system from tank(s) to ponds WC-1 and WC-2.

REF.#: K343
DATE: 05/15/85
TO: P.S. Corbett
COMPANY: KMCC
FROM: Allen Biaggi
COMPANY: NDEP
TITLE: "Solid Waste Landfill".

REF.#: K344
DATE: 07/10/91
TO:
COMPANY: KMCC
FROM:
COMPANY: KMCC
TITLE: "Hemcat - Alphanumeric Stock Catalog".

REF.#: K345
DATE: 06/11/91
TO: Scott Shaw
COMPANY: Centennial Concrete
FROM: Alan Gaddy
COMPANY: KMCC
TITLE: Construction related documents for new sodium chlorate filter cake holding area north of Unit 3.

REF.#: K346
DATE: 01/11/91
TO: Ida R. Garces
COMPANY: Sierra Technical Services Corporation
FROM: Alan Gaddy
COMPANY: KMCC
TITLE: Analytical request form (C-0-C) and analytical results - PCBs.

REF.#: K347
DATE: 01/12/76
TO: Gentlemen
COMPANY: NDEP
FROM: C.B. Armstrong
COMPANY: KMCC
TITLE: "NPDES Permit NV 0000078" - Letter reporting that KMCC has eliminated the discharge of process waste waters to the BMI ponds (zero discharge).

REF.#: K353
DATE: 11/13/87
TO:
COMPANY: KMCC
FROM: Brian Hammond
COMPANY: DataChem
TITLE: Analytical reports of soil samples taken in the vicinity of proposed SIS WC-1 and WC-2.

REF.#: K354
DATE: 00/00/90
TO:
COMPANY: KMCC
FROM:
COMPANY: KMCC
TITLE: Manifests, KMCC shipping documents, and US Ecology certificates of disposal for liner and solids for decommissioning of old P-2.

REF.#: K355
DATE: 11/14/91
TO: F.K. Downey
COMPANY: KMCC
FROM: J.H. Mashburn
COMPANY: KMCC
TITLE: Internal correspondence related to J.B. Kelley, Inc. - "Regulatory

Compliance Audit-KMCC Henderson, NV Lease, Jack B. Kelley, Inc."

REF.#: K356
DATE: 07/28/89
TO: P.S. Corbett
COMPANY: KMCC
FROM: A.J. Gaddy
COMPANY: KMCC
TITLE: Internal correspondence regarding 1,277 pound discharge of manganese dioxide to Henderson POTW in 1987.

REF.#: K357
DATE: 00/00/92
TO: Todd Croft
COMPANY: Kleinfelder
FROM: Alan Gaddy
COMPANY: KMCC
TITLE: Personal Communications.

REF.#: K358
DATE: 00/00/91
TO: Todd Croft
COMPANY: Kleinfelder
FROM: John Colt
COMPANY: J.B. Kelley, Inc.
TITLE: Personal Communications.

REF.#: K359
DATE: 02/07/92
TO: P.B. Dizikes
COMPANY: KMCC
FROM: F.K. Downey
COMPANY: KMCC
TITLE: "Regulatory Compliance Audit-KMCC Henderson, NV Lease/Koch Materials".

REF.#: K361
DATE: 00/00/65
TO:
COMPANY:
FROM:
COMPANY: KMCC
TITLE: "Henderson Plant, Cost of Production - 53 Weeks 1965". Also "Henderson Plant, Cost of Production - 52 Weeks 1964".

REF.#: K366
DATE: 05/15/92
TO: Todd Croft
COMPANY: Kleinfelder, Inc.
FROM: Alan Gaddy
COMPANY: KMCC
TITLE: Fax transmission - Hand written KMCC responses to NDEP questions concerning the Draft Phase I ECA Report.

REF.#: K371
DATE: 10/19/89
TO: Michael K. Stoker
COMPANY: U.S. Ecology
FROM: Alan Gaddy
COMPANY: KMCC
TITLE: Uniform Hazardous Waste Manifest.

REF.#: K372
DATE: 02/06/79
TO:
COMPANY: CCHD, Air Pollution Control Board
FROM:
COMPANY: KMCC
TITLE: Operating permits for various air pollution control devices.

REF.#: K373
DATE: 04/22/91
TO:
COMPANY: U.S. Ecology
FROM: Alan Gaddy
COMPANY: KMCC
TITLE: Uniform Waste Manifests #00449, 00450, and other supporting documents re: the removal and disposal of soil and concrete from the old chlorate drying pad (predates present SWMU-005).

REF.#: N001
DATE: 10/14/54
TO:
COMPANY: Southern California Chemical Research Group
FROM: David R. Stern
COMPANY:
TITLE: The Electrochemical Industry, Henderson, NV.

REF.#: N007
DATE: 10/21/46
TO:
COMPANY: The General Public
FROM: A. J. Shaver
COMPANY: Colorado River Commission
TITLE: Electro-Chemical Operations at Henderson, Clark County, Nevada, October 1946.

REF.#: N008
DATE: 03/06/47
TO: General Public
COMPANY:
FROM:
COMPANY: Henderson Nevada Chamber of Commerce
TITLE: The New Basic Magnesium Project Story.

REF.#: N009
DATE: 00/00/47
TO: General Public
COMPANY:
FROM:
COMPANY: Office of Real Property Disposal, War Assets Administration
TITLE: Basic, Plancor 201, Chemical Processing, Allied and Other Industrial Enterprises, fact sheet/buyer guide.

REF.#: N011
DATE: 08/12/51
TO:
COMPANY:
FROM: A. J. Shaver
COMPANY: Colorado River Commission of Nevada
TITLE: 15 pages of questions and answers regarding Basic Magnesium Incorporated. Additionally, "Bill of Sale" to WECCO.

REF.#: ND001
DATE: 10/09/84
TO: Rolfe B. Chase Jr.
COMPANY: KMCC
FROM: Thomas J. Fronapfel
COMPANY: NDEP
TITLE: Deficiencies in H.W. Landfill closure/post-closure plan.

REF.#: ND002
DATE: 05/05/89
TO:
COMPANY: NDEP
FROM: Alan Gaddy
COMPANY: KMCC
TITLE: First Quarter Performance Report, Chromium Mitigation Program, Kerr-McGee Chemical Corporation, Henderson, Nevada, January-March, 1989.

REF.#: ND004
DATE: 06/19/80
TO: C. B. Armstrong
COMPANY: KMCC
FROM: Kenneth D. Greenberg
COMPANY: EPA
TITLE: NPDES Compliance Monitoring Report.

REF.#: ND006
DATE: 04/13/88
TO:
COMPANY: NDEP
FROM: Jeff Lux
COMPANY: KMCC
TITLE: First Quarter Performance Report, Chromium Mitigation Program, Kerr-McGee Chemical Corporation, Henderson, Nevada, April 13, 1988.

REF.#: ND009
DATE: 04/21/83
TO: Harry Van Drielen
COMPANY: NDEP
FROM: R. B. Chase
COMPANY: KMCC
TITLE: Response to questions regarding an anolyte leak which occurred on January

16, 1983.

REF.#: ND010
DATE: 07/26/88
TO:
COMPANY: NDEP
FROM: Jeff Lux
COMPANY: KMCC
TITLE: Second Quarter Performance Report, Chromium Mitigation Program, Kerr-McGee Chemical Corporation, Henderson, Nevada, July 26, 1988.

REF.#: ND039
DATE: 01/25/90
TO: Joe Livak
COMPANY: NDEP
FROM: Patrick S. Corbett
COMPANY: KMCC
TITLE: Fourth Quarter Performance Report, Chromium Mitigation Program, Kerr-McGee Chemical Corporation, Henderson, Nevada, October-December, 1989.

REF.#: ND048
DATE: 03/11/86
TO: Rolfe B. Chase
COMPANY: KMCC
FROM: Joseph S. Livak
COMPANY: NDEP
TITLE: Finding of Alleged Violation dated 8/11/86.

REF.#: ND049
DATE: 11/29/84
TO: Thomas J. Fronapfel
COMPANY: NDEP
FROM: R. B. Chase
COMPANY: KMCC
TITLE: KMCC Henderson Facility, Status Report - Groundwater Monitoring and Contaminate Mitigation Program.

REF.#: ND053
DATE: 06/18/82
TO:
COMPANY:
FROM: Steven H. Simanonok
COMPANY: USEPA
TITLE: List of owner/lessee/manufactures at BMI Complex; area geology, information

on surface water (upsets result in discharge reaching Alpha Ditch); air pollution; summary of on-site/off-site waste disposal.

REF.#: ND054
DATE: 12/13/90
TO:
COMPANY:
FROM:
COMPANY: NDEP
TITLE: "Briefing Book, environmental issues associated with the BMI complex".

REF.#: OT001
DATE: 00/00/88
TO: General Public
COMPANY:
FROM: K. Brother and T. Katzer
COMPANY: Las Vegas Valley Water District
TITLE: Ground Water Chemistry changes resulting from stressed aquifer system in Las Vegas Valley, Clark Co., Nevada.

REF.#: OT002
DATE: 00/00/48
TO: General Public
COMPANY:
FROM: G. B. Maxey
COMPANY: Nevada Department of Conservation and Natural Resources
TITLE: Geology and Water Resources of the Las Vegas, Pahrump and Indian Springs Valley, Clark and Nye Counties, Nevada.

REF.#: OT003
DATE: 00/00/81
TO:
COMPANY:
FROM: John W. Bell
COMPANY: Nevada Division of Mines and Geology
TITLE: Subsidence in Las Vegas Valley.

REF.#: OT004
DATE: 00/00/65
TO: General Public
COMPANY:
FROM: C. R. Longwell
COMPANY: Nevada Division of Mines and Geology
TITLE: Geology and Mineral Deposits of Clark County, Nevada.

REF.#: UB001
DATE: 09/00/89
TO:
COMPANY: U.S. Bureau of Reclamation
FROM:
COMPANY: U.S. Bureau of Reclamation
TITLE: Colorado River Basin Salinity Control Project Point Source Division, Las Vegas Wash Unit, Nevada, Final Report.

REF.#: UB003
DATE: 10/00/82
TO:
COMPANY: U.S. Bureau of Reclamation
FROM:
COMPANY: U.S. Bureau of Reclamation
TITLE: Colorado River Basin Salinity Control Project Point Source Division, Las Vegas Wash Unit, Nevada, Status Report.

REF.#: UB008
DATE: 10/00/82
TO:
COMPANY: U.S. Bureau of Reclamation
FROM:
COMPANY: U.S. Bureau of Reclamation
TITLE: Colorado River Basin Salinity Control Project Point Source Division, Las Vegas Wash Unit, Nevada, Status Report Index.

REF.#: UB015
DATE: 07/00/84
TO: Commissioner, Washington, D.C.
COMPANY: U.S. Bureau of Reclamation
FROM: Regional Director
COMPANY: U.S. Dept. of the Interior, Bureau of Reclamation
TITLE: Verification Plan Report, Pittman Verification program, Las Vegas Wash Unit, Nevada.

REF.#: UB018
DATE: 04/00/86
TO:
COMPANY: U.S. Bureau of Reclamation
FROM:
COMPANY: U.S. Bureau of Reclamation
TITLE: Las Vegas Wash Unit, Nevada, Program Management Document

REF.#: UE006
DATE: 03/12/90
TO:
COMPANY: USEPA
FROM: Patrick S. Corbett
COMPANY: KMCC
TITLE: "Notification of Hazardous Waste Activity"

REF.#: UE007
DATE: 05/07/90
TO: Elise Robertson
COMPANY: USEPA
FROM: Patrick S. Corbett
COMPANY: KMCC
TITLE: "Notification of Hazardous Waste Activity"

REF.#: UE016
DATE: 01/24/89
TO:
COMPANY: USEPA
FROM:
COMPANY: USEPA
TITLE: "Inspection Report, TSCA PCB Investigation"

REF.#: UE021
DATE: 02/06/90
TO: Tom Fronopfel
COMPANY: NDEP
FROM: P.S. Corbett
COMPANY: KMCC
TITLE: "1989 PCB Annual Report" and inspection data sheets covering the period 1/1/89 to 2/5/90. Also, copies of manifests used in the disposal and a Certificate of Disposal of PCB material.

REF.#: UE022
DATE: 07/24/87
TO: Thomas J. Fronapfel
COMPANY: NDEP
FROM: Patrick S. Corbett
COMPANY: KMCC
TITLE: "KMCC Henderson Facility, EPA ID. No. NVD 008290330, Post Closure Permit Application, Hazardous Waste Landfill"

REF.#: UE024
DATE: 06/19/80
TO: C.B. Armstrong
COMPANY:
FROM: Kenneth D. Greenberg
COMPANY: USEPA
TITLE: "EPA, Region IX, Surveillance and Analysis Division, NPDES Compliance Monitoring Report"

REF.#: UE028
DATE: 00/00/86
TO:
COMPANY: EPA
FROM:
COMPANY: USEPA
TITLE: "Draft Fact Sheet"

REF.#: UE030
DATE: 08/14/74
TO: Richard L. O'Connell
COMPANY: USEPA
FROM: C.B. Armstrong
COMPANY: KMCC
TITLE: "Plan for monitoring Pond Leakage; Spill Prevention and Containment Plan".

REF.#: UE032
DATE: 09/13/89
TO: Joe Livak
COMPANY: NDEP
FROM: Patrick S. Corbett
COMPANY: KMCC
TITLE: Once through cooling water event with discharge through monitoring point 002.

REF.#: UE033
DATE: 10/19/89
TO: Joe Livak
COMPANY: NDEP
FROM: Patrick S. Corbett
COMPANY: KMCC
TITLE: "NDEP September 1989 Discharge Monitoring Report - NPDES #NV0000078".

REF.#: UE037
DATE: 02/27/90
TO: Joe Livak
COMPANY: NDEP
FROM: Patrick S. Corbett
COMPANY: KMCC
TITLE: "NDEP January 1990 Discharge Monitoring Report - NPDES #NV0000078".

REF.#: UE041
DATE: 07/24/90
TO: Joe Livak
COMPANY: NDEP
FROM: Patrick S. Corbett
COMPANY: KMCC
TITLE: "NDEP June 1990 Discharge Monitoring Report - NPDES #NV0000078".

REF.#: UE042
DATE: 08/27/90
TO: Joe Livak
COMPANY: NDEP
FROM: Patrick S. Corbett
COMPANY: KMCC
TITLE: "NDEP July 1990 Discharge Monitoring Report - NPDES #NV0000078".

REF.#: UE043
DATE: 09/26/90
TO: Joe Livak
COMPANY: NDEP
FROM: Patrick S. Corbett
COMPANY: KMCC
TITLE: "NDEP August 1990 Discharge Monitoring Report - NPDES #NV0000078".

REF.#: UE044
DATE: 10/26/90
TO: Joe Livak
COMPANY: NDEP
FROM: Patrick S. Corbett
COMPANY: KMCC
TITLE: "NDEP September 1990 Discharge Monitoring Report - NPDES #NV0000078".

REF.#: UE045
DATE: 11/27/90
TO: Joe Livak
COMPANY: NDEP
FROM: Patrick S. Corbett
COMPANY: KMCC
TITLE: "NDEP October 1990 Discharge Monitoring Report - NPDES #NV0000078".

REF.#: UE046
DATE: 12/17/90
TO: Joe Livak
COMPANY: NDEP
FROM: Patrick S. Corbett
COMPANY: KMCC
TITLE: "NDEP November 1990 Discharge Monitoring Report - NPDES #NV0000078".

REF.#: UE047
DATE: 01/24/91
TO: Joe Livak
COMPANY: NDEP
FROM: Patrick S. Corbett
COMPANY: KMCC
TITLE: "NDEP December 1990 Discharge Monitoring Report (DMR) - NPDES #NV0000078".

REF.#: UE048
DATE: 02/27/91
TO: Joe Livak
COMPANY: NDEP
FROM: Patrick S. Corbett
COMPANY: KMCC
TITLE: "NDEP January 1991 Discharge Monitoring Report (DMR) - NPDES #NV0000078".

REF.#: UE049
DATE: 03/27/91
TO: Joe Livak
COMPANY: NDEP
FROM: Patrick S. Corbett
COMPANY: KMCC
TITLE: "NDEP February 1991 Discharge Monitoring Report (DMR) - NPDES #NV0000078".

REF.#: UE050
DATE: 04/25/91
TO: Joe Livak
COMPANY: NDEP
FROM: Patrick S. Corbett
COMPANY: KMCC
TITLE: "NDEP March 1991 Discharge Monitoring Report (DMR) - NPDES #NV0000078".

REF.#: UE051
DATE: 05/21/91
TO:
COMPANY: NDEP
FROM:
COMPANY: KMCC
TITLE: Disposal amounts and flow analysis for DMR covering April 1991. Note: No cover sheet.

REF.#: UE052
DATE: 06/25/91
TO: Gentlemen
COMPANY: NDEP
FROM: Patrick S. Corbett
COMPANY: KMCC
TITLE: "NDEP May 1991 Discharge Monitoring Report (DMR) - NPDES #NV0000078".

REF.#: UE053
DATE: 07/24/91
TO: Gentlemen
COMPANY: NDEP
FROM: Patrick S. Corbett
COMPANY: KMCC
TITLE: "NDEP June 1991 Discharge Monitoring Report (DMR) - NPDES #NV0000078".

REF.#: UE054
DATE: 09/25/91
TO: Gentlemen
COMPANY: NDEP
FROM: Patrick S. Corbett
COMPANY: KMCC
TITLE: "NDEP August 1991 Discharge Monitoring report (DMR) - NPDES #NV0000078".

REF.#: UE055
DATE: 10/28/91
TO: Gentlemen
COMPANY: NDEP
FROM: Patrick S. Corbett
COMPANY: KMCC
TITLE: "September 1991 Discharge Monitoring Report (DMR), Henderson Facility - NPDES #NV0000078".

REF.#: UE056
DATE: 11/27/91
TO: Gentlemen
COMPANY: NDEP
FROM: Patrick S. Corbett
COMPANY: KMCC
TITLE: "October 1991 Discharge Monitoring Report (DMR), Henderson Facility - NPDES #NV0000078".

REF.#: UE057
DATE: 12/18/91
TO: Gentlemen
COMPANY: NDEP
FROM: Patrick S. Corbett
COMPANY: KMCC
TITLE: "November 1991 Discharge Monitoring Report (DMR), Henderson Facility - NPDES #NV0000078".

REF.#: UE059
DATE: 06/01/81
TO: Ken Greenburg
COMPANY: EPA
FROM: Eddy J. Forman
COMPANY: JRB Associates, Inc.
TITLE: "Henderson Industrial Complex, Hazardous Waste Investigation, U.S. EPA Contract 68-01-5052, Directive of Work #23".

REF.#: UE060
DATE: 00/00/82
TO:
COMPANY: EPA
FROM:
COMPANY: Timet
TITLE: BMI Complex Waste Water System

REF.#: UE061
DATE: 12/00/80
TO:
COMPANY:
FROM: Ken Greenberg
COMPANY: EPA
TITLE: Tables of waste and waste disposal for each BMI company, BMI dump, and BMI owned unlined ponds including City of Henderson.

REF.#: UE062
DATE: 00/00/83
TO:
COMPANY:
FROM:
COMPANY: EPA
TITLE: "Appendix B - Public Health Risk Assessment".

REF.#: UE063
DATE: 00/00/79
TO:
COMPANY: EPA
FROM:
COMPANY: EPA
TITLE: Hand written notes - Chromium and hexavalent chromium detected in storm water discharge from Stauffer.

Rev.3.0
FINAL

REF.#: UE065
DATE: 05/17/92
TO: A.L. Anderson
COMPANY: KMCC
FROM: R.E. Harris
COMPANY: KMCC
TITLE: " Analysis of Henderson Plant EIMCO Tails for RCRA Leach Test".

REF.#: UE070
DATE: 03/25/80
TO: Curtis Tidwell
COMPANY: State Industries, Inc.
FROM: Clyde B. Eller
COMPANY: EPA
TITLE: EPA request to determine whether hazardous wastes have been or are being stored or transported on or off State Industries's property.

REF.#: UE071
DATE: 04/14/80
TO: Geoffrey Billingsley
COMPANY: City of Henderson
FROM: Curtis A. Tidwell
COMPANY: State Industries, Inc.
TITLE: Completed copy of the questionnaire of industrial waste inventory - RE: Raw material usage.

REF.#: UE072
DATE: 04/18/80
TO: Clyde B. Eller
COMPANY: EPA
FROM: Daniel D. Walker, Jr.
COMPANY: Flintkote Lime Company
TITLE: Response to EPA questions (letter dated 3/25/80) regarding operation, wastes and waste disposal.

REF.#: UE073
DATE: 04/23/80
TO: Clyde B. Eller
COMPANY: EPA
FROM: Glen C. Taylor
COMPANY: Basic Management, Inc.
TITLE: BMI response to March 25, 1980 EPA survey letter.

REF.#: UE074
DATE: 04/23/80
TO: Clyde B. Eller
COMPANY: EPA
FROM: Adolf Han
COMPANY: State Industries, Inc.
TITLE: State Industries response to March 25, 1980 EPA survey letter.

REF.#: UE075
DATE: 05/15/80
TO: Marvin Tabeau
COMPANY: NDEP
FROM: Jon Meckle
COMPANY: EPA
TITLE: Hand written notes - KMCC is repairing 2 ponds, State Stove has informed DEP of a ripped pond lining, and Stauffer is having problems sealing the LG032 well.

REF.#: UE076
DATE: 06/18/80
TO: Hal Wurzer
COMPANY: Montrose Chemical Company
FROM: Kenneth D. Greenberg
COMPANY: EPA
TITLE: "Environmental Protection Agency, Region IX, Surveillance and Analysis Division, NPDES Compliance Monitoring Report - Stauffer Chemical Company".

REF.#: UE078
DATE: 08/05/80
TO: Clyde Eller
COMPANY: EPA
FROM: G. R. Stewart
COMPANY: Stauffer Chemical Company
TITLE: Response to EPA letter dated August 21, 1980.

REF.#: UE079
DATE: 08/08/80
TO: Bill Wilson
COMPANY: EPA
FROM: Glen C. Taylor
COMPANY: Basic Management, Inc.
TITLE: "Notification of Hazardous Waste Activities" - The disposal site (dump) was closed and debris covered by February, 1980.

REF.#: UE080
DATE: 09/03/80
TO: Clyde B. Eller
COMPANY: EPA
FROM: Glen C. Taylor
COMPANY: Basic Management, Inc.
TITLE: Response to EPA letter dated August 21, 1980.

REF.#: UE083
DATE: 01/00/81
TO:
COMPANY: Basic Management, Inc.
FROM:
COMPANY: EPA
TITLE: "Case Development Plan, Basic Management Incorporated Industrial Complex, Henderson, Nevada".

REF.#: UE085
DATE: 06/01/81
TO:
COMPANY: EPA
FROM:
COMPANY: BMI
TITLE: "Notification of Hazardous Waste Site".

REF.#: UE086
DATE: 06/01/81
TO:
COMPANY: EPA
FROM: Glen C. Taylor
COMPANY: Basic Management, Inc.
TITLE: "Notification of Hazardous Waste Site".

REF.#: UE088
DATE: 06/04/81
TO:
COMPANY: EPA
FROM: Charles B. Armstrong
COMPANY: KMCC
TITLE: "Notification of Hazardous Waste Site"

REF.#: UE091
DATE: 00/00/76
TO:
COMPANY: EPA
FROM:
COMPANY: Stauffer
TITLE: Stauffer achieved zero discharge by April 1, 1976.

REF.#: UE097
DATE: 01/27/82
TO: Helmut Ogris
COMPANY: U.S. Homes, LV
FROM: David Moser
COMPANY: EPA
TITLE: "Sampling Pipe at Old BMI Ponds".

REF.#: UE098
DATE: 01/28/82
TO: Art Tuma
COMPANY: U.S. Bureau of Reclamation
FROM: David Moser
COMPANY: EPA
TITLE: "Telephone Conversation Report" - The 4 inch pipe mentioned in doc. # UE097 is used by the U.S. Bureau of Reclamation for an evaporation study.

REF.#: UE099
DATE: 02/01/82
TO: Jon Meckle
COMPANY: EPA
FROM: Vince Marci
COMPANY: Ecology & Environment
TITLE: "BMI Sampling".

REF.#: UE102
DATE: 03/18/82
TO: Charles Armstrong
COMPANY: KMCC
FROM:
COMPANY: Clark County Health District
TITLE: Data on ammonia sources.

REF.#: UE103
DATE: 03/23/82
TO: Marvin Tebeau
COMPANY: NDEP
FROM: Leonard L. Spann
COMPANY: State Industries, Inc.
TITLE: Report on State Industries liquid waste disposal program from 1970 to present.

REF.#: UE104
DATE: 03/26/82
TO: Gentlemen
COMPANY: NDEP
FROM: James V. Wiseman
COMPANY: Stauffer Chemical Company
TITLE: "Henderson Groundwater Investigation" - Stauffer response to NDEP Order of February 25, 1982.

REF.#: UE107
DATE: 03/31/82
TO: L.H. Dodgion
COMPANY: EPA
FROM: Glen C. Taylor
COMPANY: Basic Management, Inc.
TITLE: BMI response to February 25, 1982 NDEP Order - description of waste disposal.

REF.#: UE108
DATE: 04/00/82
TO: Lew Dodgion
COMPANY: NDEP
FROM:
COMPANY: Waste Management Staff
TITLE: "Summary of BMI Complex Responses to Order Issued February 25, 1982".

REF.#: UE114
DATE: 05/18/83
TO: H. LaVerne Rosse
COMPANY: NDEP
FROM: Leonard L. Spann
COMPANY: State Industries, Inc.
TITLE: State Industries response to NDEP for waste information RE: Cyanide and BMI dump use by State Industries.

REF.#: UE131
DATE: 07/06/83
TO: R.B. Chase, Jr.
COMPANY: KMCC
FROM: William D. Wilson
COMPANY: EPA
TITLE: "Henderson Facility [(EPA ID # NVD008298330) not able to completely read]"
- "not required to submit Part B permit application as requested 01/28/83"
for surface impoundments and landfill.

REF.#: UE143
DATE: 07/18/84
TO: File
COMPANY: EPA
FROM: G. Upson
COMPANY: EPA
TITLE: "Contact Report" - Hand written notes regarding description of the three Henderson WWTP and dates of operation.

REF.#: UE146
DATE: 05/10/85
TO: Robert M. Mandel
COMPANY: EPA
FROM: Geoffrey Upson
COMPANY: Ecology and Environment, Inc.
TITLE: "Phase IIB Sampling Plan, Stauffer Chemical Company, BMI Complex, Henderson, Nevada".

REF.#: UL001
DATE: 12/00/71
TO:
COMPANY: UNLV
FROM: Maryellen V. Saddovich
COMPANY: Student - UNLV
TITLE: Basic Magnesium, Incorporated and the Industrialization of Southern Nevada During World War II - Masters Thesis.

REF.#: UL002
DATE: 01/15/48
TO: General Public
COMPANY:
FROM:
COMPANY: UNLV Library (Henderson Shopping News)
TITLE: Full details of operations At Basic Told in expert's report.

REF.#: UL012
DATE: 10/00/43
TO: General Public
COMPANY:
FROM: Robert H. Ramsey
COMPANY: Chemical and Metallurgical Engineering
TITLE: Magnesium Production at the World's Largest Plant.

REF.#: UL013
DATE: 01/00/43
TO: General Public
COMPANY:
FROM:
COMPANY: The Flow Line
TITLE: Nevada's Light Metal Thunderbolt and Desert Giant Produces Hell for Hitler.

REF.#: UL020
DATE: 04/30/45
TO: F. O. Chase
COMPANY: Basic Magnesium Incorporated
FROM: Roy E. Thomas
COMPANY: Basic Magnesium Incorporated
TITLE: - Factual History of engineering, Basic Magnesium, Incorporated, Defense Plant Corporation, Plancors 201 & 201 - H, Henderson and Gibbs, Nevada.

older@enviroincorp.com, 29-Dec
18:20

APPENDIX B
PLATES

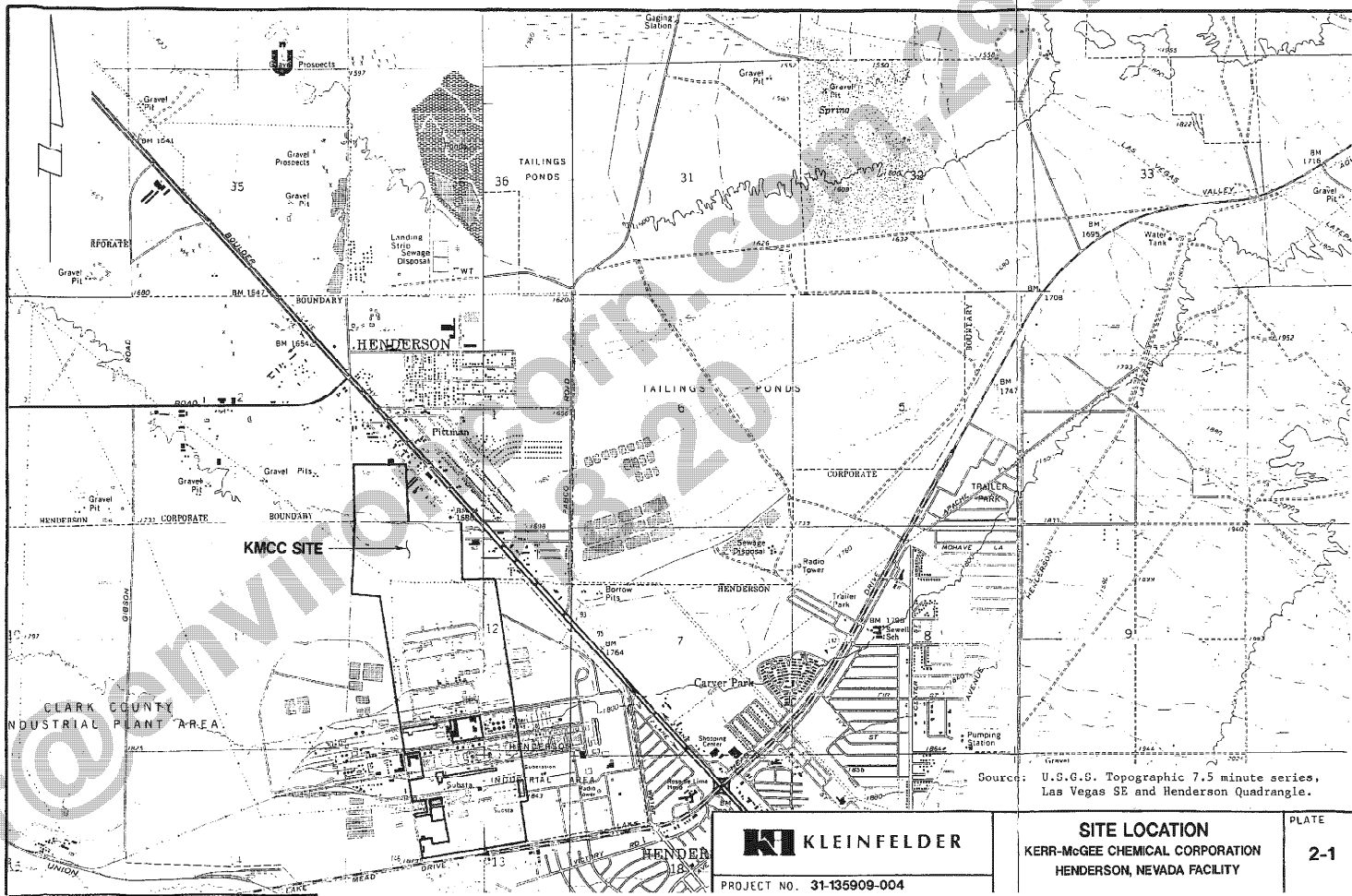

Source: U.S.G.S. Topographic 7.5 minute series, Las Vegas SE and Henderson Quadrangle.

KI KLEINFELDER
 PROJECT NO. 31-135909-004

SITE LOCATION
 KERR-McGEE CHEMICAL CORPORATION
 HENDERSON, NEVADA FACILITY

PLATE
2-1

KMCC DR
 04-0008802

L

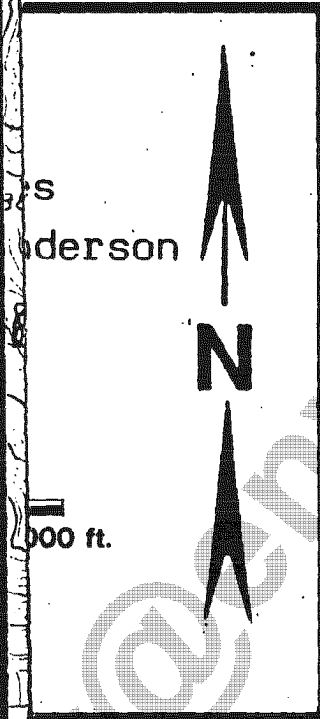
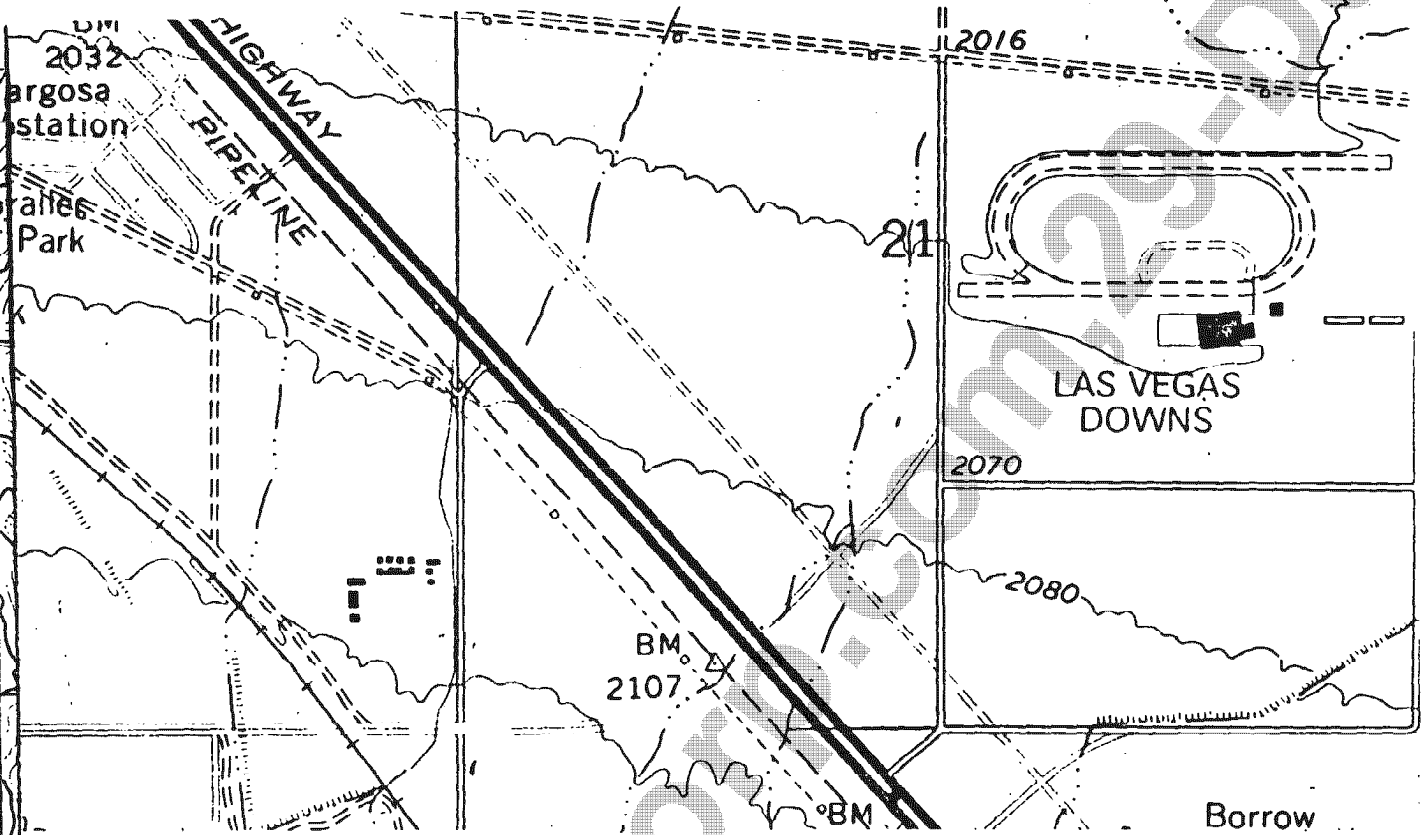

**PLATE 3-1
BMI COMPLEX AREA**

MODIFIED AFTER MAP PROVIDED BY GERAGHTY & MILLER, INC.

NV08501	REVISIONS 1.0 (FINAL)
DATE 4-15-93	



GERAGHTY & MILLER, INC.

Ground Water Consultants

5270 Neil Road, Suite 101

Reno, Nevada 89502

57'30"

685 (BOULDER C
3055-IV

EXPLANATION :



















-  INDICATES STREET LIGHT
-  INDICATES RETAINING WALL
-  INDICATES PHOTO CENTER
-  INDICATES FENCE
-  INDICATES GUARD RAIL
-  INDICATES WATER
-  INDICATES DIRT ROAD
-  INDICATES PAVED ROAD
-  INDICATES CURB AND GUTTER
-  SYMBOL INDICATES GAS SHUTOFF VALVE
-  - INDICATES FIRE HYDRANT
-  - INDICATES WATER CANNON
-  INDICATES POWER POLE
-  INDICATES CULVERT HEAD
-  INDICATES TREE
-  INDICATES BRUSH
-  INDICATES HORIZ. VERT. CONTROL
-  INDICATES PROPERTY LINE

PLATE 3-2
SITE PLAN



K KLEINFELDER

**KMCC TENANTS
SOUTHERN PORTION OF**

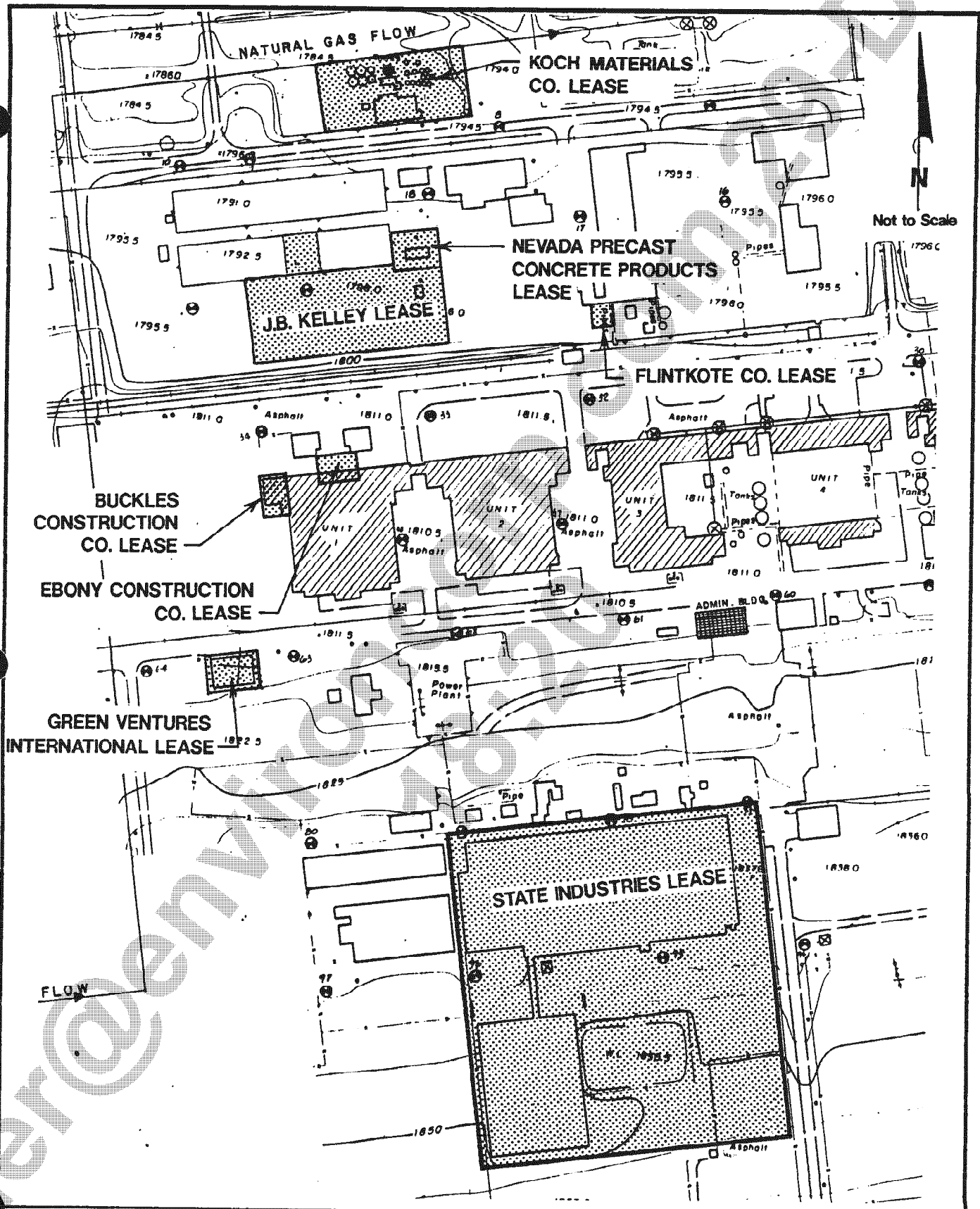
PLATE

7-1

PI
M -

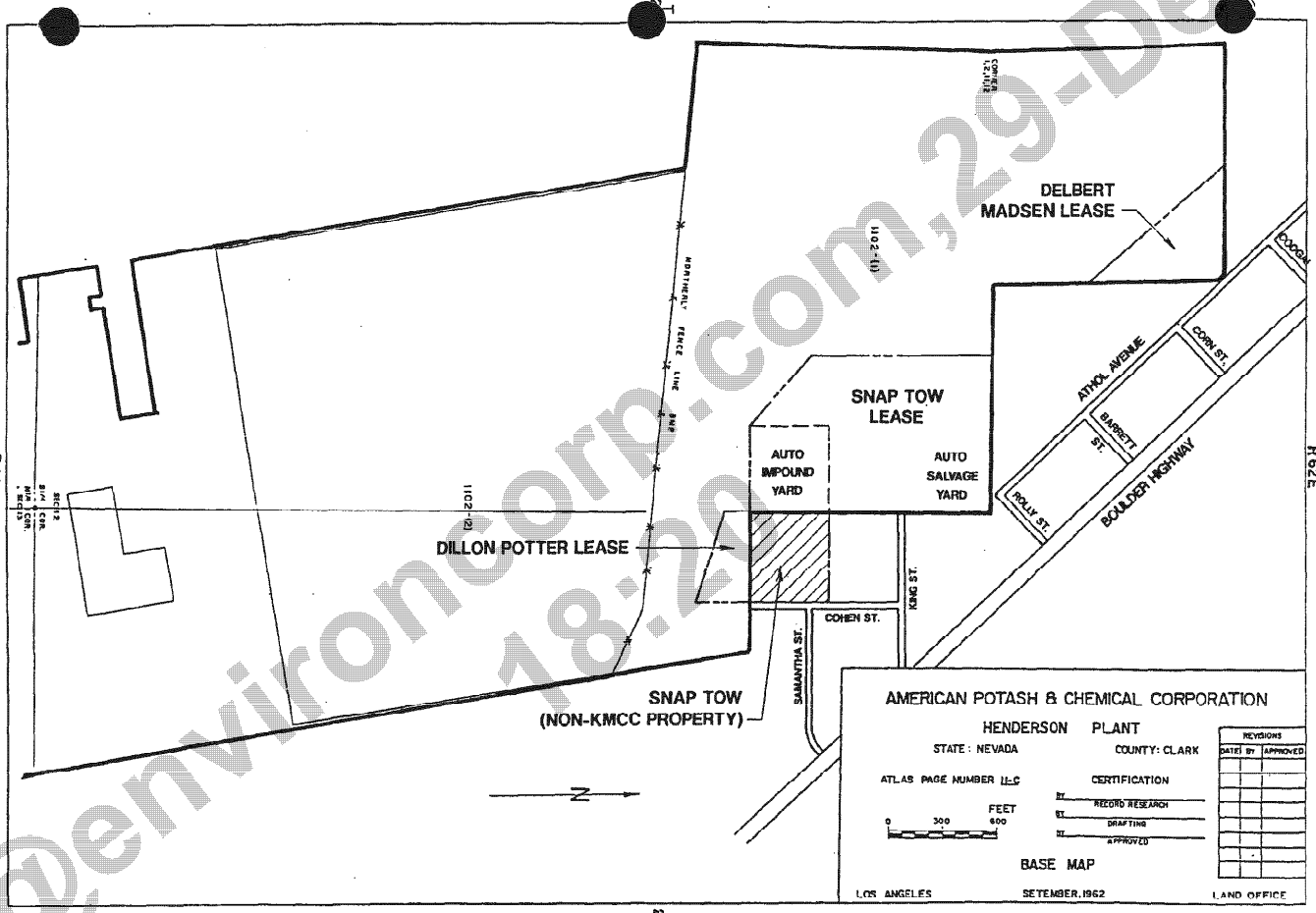

Modified after AP & CC 1962 Base Map provided by KMCC.
 Reference: Landisair Aerial Photo, #G-16, June 15, 1991



KMCC TENANTS - NORTHEDAI PLATE

KMCC DR
04-0008806

M-16

T

H

der@environcorp.com, 29-Dec
18:20



APPENDIX C
WASTE INDEX

|

APPENDIX C

INDEX OF WASTES

Table C-1 is an index of wastes. This table reflects wastes generated from production of chlorates, perchlorates, manganese dioxide, and boron compounds. The combined wastes generated by WECCO, AP & CC, and KMCC between 1945 and 1991 are included. This index was generated from a review of documents and personal communications with the KMCC Environmental Engineer. Information is presented (when available) for the following categories:

- o Wastes generated;
- o Disposal location of wastes;
- o Time frame disposal methods were used; and
- o Estimated quantity of waste disposed of during the time frame.

TABLE C-1 INDEX OF WASTES

Process	Generated	Disposal	Date	Quantity	References
CHLORATES					
Sodium Chlorate	Sodium Chlorate filter cake and filter slurry or cakes containing diatomaceous earth, hexavalent and trivalent chromium, and other impurities	Unlined BMI ponds via Beta Ditch	1945-1974	391,000 ft ³	K037, K056, K253
		Disposed at BMI landfill	1975-1980 ⁽¹⁾	90,000 ft ³	K003, K013, K037, K056, UE030
		On-site disposal at HW landfill	1980-1983	3,000 yd ³	K056, K095, K108, K128, K130, K138
		Off-site disposal at U.S. Ecology, Inc., Beatty, Nevada Facility	1983-Present ⁽²⁾	NR/NC	K095, K286
	Liquid Wastes	Lined KMCC Pond P-1 Lined KMCC Pond S-1	1972-1983 ⁽³⁾ 1974-1982 ⁽³⁾	NR/NC	K031, K037, K117, K158A, K161, K170
	Liquids	Recycle to process	1979- Present ⁽³⁾	NR/NC	K037, K056
Potassium Chlorate	Filter cake and process liquid slurry (mother liquor)	Unlined BMI ponds via Beta Ditch	1945-1974 ⁽³⁾	ND	K037, K039, K056, K176
		Lined KMCC Pond P-1 Lined KMCC Pond S-1	1972-1983 ⁽³⁾ 1974-1982 ⁽³⁾	NR/NC	K031, K037, K039, K056, K095, K105, K130, K176

TABLE C-1 INDEX OF WASTES

Process	Generated	Disposal	Date	Quantity	References
PERCHLORATES					
Sodium Perchlorate	Filter cake with and cell bottoms with recoverable platinum values	By-product material manifested as "recyclable material" and shipped off-site to metal recovery process	1964-Present	NR/NC	K335, K336, K357, K361, K366 UE006, UE007
	Liquid Wastes	Unlined BMI ponds via Beta Ditch	1951-1976	ND	K037, K039, K056, K176 K277, K347
	Liquid Wastes	Lined KMCC Pond P-1 Lined KMCC Pond S-1	1972-1983 1974-1983	NR/NC	K037, K039, K095 K124, K347, UE024, UE030
	Liquids	Recycled to process	1983-Present	NR/NC	K158A, K357
Potassium Perchlorate	Filter slurry, mother liquor, or cakes containing diatomaceous earth, NaCl, KCl, KClO ₃ , KClO ₄ , NaClO ₄ , Na ₂ CO ₃ , CaCO ₃ , Cr	Unlined BMI ponds via Beta Ditch Lined KMCC Pond P-1 Lined KMCC Pond P-1 Lined KMCC Pond S-1	1945-1976 1972-1982 1972-1983 ⁽³⁾ 1974-1982 ⁽³⁾	293,756 tons NR/NC	K037, K039, K056, K083 K278 K003, K013, K037, K039, K105, K347, UE024, UE030
Magnesium Perchlorate	Liquid waste	Unlined BMI ponds via Beta Ditch Lined KMCC Ponds S-1 & P-1	1969-1976 1972/1974 ⁽³⁾ to 1976	ND ND	K037, K039, K056, K347 K003, K013, K037, K039, K105, K176, K255, K347, UE024, UE030

TABLE C-1 INDEX OF WASTES

Process	Generated	Disposal	Date	Quantity	References
Ammonium Perchlorate	Filter slurry or cakes containing diatomaceous earth; and CaCO ₃ , CaSO ₄ , and MgSO ₄ , Cr(OH) ₃	Unlined BMI ponds via Beta Ditch	1951-1974	ND	K003, K013, K031, K039, K158A, K278, K347, UE030
		Lined KMCC Ponds AP-1 through AP-5 as storage for recycle to process	1974-Present	NR/NC	K158A, UE024, UE030
		Dried residue from Lined KMCC Pond AP-2 disposed of at BMI landfill	Pre-1980	50 tons	K037, K039, UE083, UE146
		Dried residues from Lined KMCC Ponds AP-1, AP-2, and AP-3 disposed off-site at U.S. Ecology, Inc. Beatty, Nevada	1989-Present	NR/NC	K305, K320, K371
	Caustic scrubber solution (NaOH)	Unlined BMI ponds via Beta Ditch	Pre-1974	ND	K253
		Lined KMCC Old Pond P-2	1972-1990 ⁽³⁾	ND	K220, K003, UE024
		Lined KMCC New Pond P-2 or directly to Unit 3 (sodium chlorate process area)	1990-Present	ND	K357
	Overflow from AP cooling tower	Unlined BMI ponds via Beta Ditch	Pre-1974	ND	K357
		Lined KMCC Ponds AP-1 through AP-5	1974-Present	ND	K357
	Soils impacted by firewater (1990)		Off-site disposal at U.S. Ecology, Inc., Beatty, Nevada	1990	NR/NC

TABLE C-1 INDEX OF WASTES (Continued)

Process	Generated	Disposal	Date	Quantity	References
Cyclone Dust (Rotoclone)	Particulate emissions from central devices are below levels of concern.	Dissolved in water bath emission control devices and recycled to process.	1951-Present	NR/NC	K278
<u>MANGANESE</u>					
Manganese Dioxide	Manganese tailings-solids (Heavy metal sulfides)	Slurried in liquid and sluiced to on-site unlined leach beds	1951-1975	896,000 ft ³	K037, K039, K056, K164, K253
		Placed as a moist cake in on-site nonhazardous tailings area	1975-Present ⁽³⁾	NR/NC	K003, K013, K037, K039, K056, K164, K253, UE030
	Manganese tailings-liquids	Leach beds on KMCC property	1951-1975	330,000,000 gallons	K037, K039, K056, K164, K253
		Recycled to process	1975-Present	NR/NC	K253
	Manganese dioxide product washwater (manganese dioxide)	City of Henderson POTW via sanitary sewer	Pre-1989	ND	K356
			Lined KMCC Ponds WC-1 and/or WC-2	1989-Present	NR/NC
Calcine belt filter washwater (potassium, potassium phosphate, manganese, and other trace constituents)		Lined KMCC Pond MN-1	1983-1989	NR/NC	K117, K253, K334

TABLE C-1 INDEX OF WASTES (Continued)

Process	Generated	Disposal	Date	Quantity	References
	Manganese dioxide cathode wash solution (sodium hexametaphosphate, water, calcium, magnesium, manganese from cathode scale, and tank mud)	Lined KMCC Ponds C-1 and MN-1	1975-Present	5,000 gallons once or twice a week	K117, K158A, K269, K347, ND004
		Lined KMCC Pond MN-1	1989-Present	infrequent	K357
	Barium Sulfide	Off-site disposal at U.S. Ecology, Inc., Beatty, Nevada Facility	Pre-1980	709 ft ³ drummed	K037, K253, K275
	Scrap and spent graphite anodes (carbon)	Sold to steel mills and foundaries	1960-1981	NR/NC	K322, K323, K324
	Soils impacted by anolyte/sulfuric acid spills/leaks	Manganese tailings pile	1980 (6)-Present	NR/NC	K070, K070A, K104A, K140A, K146A, K146C, K168, K172, K173, K170, ND009

TABLE C-1 INDEX OF WASTES (Continued)

Process	Generated	Disposal	Date	Quantity	References
BORON					
Elemental Boron	Boron process neutralization tank waste solution (contains sodium carbonate, magnesium sulfate, sodium borate, and sodium sulfate) ⁽⁵⁾	Unlined BMI ponds via Beta Ditch	1972-1976	1,000,000 gallons	K031, K037, K039, K056, K083, K117, K170, K179, K257, K258, K347
		Lined KMCC Ponds S-1 & P-1	1976-1983	1,125,000+ gallons through July 1983	K031, K037, K038, K056 K083, K117, K170, K179 K257, K258, K347
		Lined KMCC Pond C-1	1975-Present	NR/NC	K158A, CA017
Boron Trichloride and Boron Tribromide	Spent Carbon Residue	BMI landfill	1972-1979	100,000 pounds	K039, K056, K117
		Nonhazardous disposal (local sanitary landfill).	1979-Present	NR/NC	K039, K117
	Cooling Tower Blowdown (Unit 5) and Reboiler Waste	Unlined BMI ponds via Beta Ditch	1972-1976	NR/NC	K039, K056, K117, K170, K179, K257, K347
		Lined KMCC Ponds S-1 & P-1	1976-1983		
		Lined KMCC Pond C-1	1983-Present		
	Halide Wall Solid and Screen Filter Waste	Unlined BMI ponds via Beta Ditch	1972-1976	NR/NC	K039, K056, K117, K170, K179, K257, K347
Lined KMCC Ponds P-1, S-1		1976-1983	ND		
Lined KMCC Pond C-1		1983-1990	ND		
Wet scrubber liquid waste		Unit 5 cooling tower	1972-Present	NR/NC	K170, K179, K257, K357

TABLE C-1 INDEX OF WASTES (Continued)

Process	Generated	Disposal	Date	Quantity	References
OTHER	Plant Blowdown Effluent (wet) scrubber liquid waste stream) from boilers and cooling towers. Contains sodium hexametaphosphate neutralized sulfuric acid, and high boiling point compounds)	Unlined BMI ponds via Beta Ditch	1972-1974	ND	K039, K046, K117, K170, K179, K347
		Lined KMCC Ponds S-1, P-1	1974-1982	NR/NC	K039, K056, K117, K170, K179, K347
		Lined KMCC Pond C-1	1975-Present		
Groundwater Treatment Unit	Iron oxide sludge	Off-site disposal at U.S. Ecology, Beatty, Nevada Facility	1987-Present	NR/NC	K318, K357
PCB	PCB contaminated solids	Off-site disposal at U.S. Ecology, Beatty, Nevada Facility	Pre-1980	144 ft ³ drummed	K037, K260, K261, K321, K346
Old Main Cooling Tower	Old Main Cooling tower effluent, leaks, spills	Unlined BMI Ponds via Beta Ditch	Pre-1976	ND	K034, K158A, UB001, UB018
	Old Main Cooling Tower Effluent	Discharged to Lined KMCC Ponds C-1 (for evaporation) or WC-1/WC-2 as storage for recycle back to process	1976-1989	NR/NC	K038, K158A, ND048
	Old Main Cooling Tower Upsets	Las Vegas Wash via Beta Ditch and the Alpha ditch or Pittman by-pass pipeline	1976-1989	NR/NC	K034, K326, K327, K328, K329, K330, K331, K332, K333, K339, K146A, K146C, K158A, N009, N011, UB001, UB018

TABLE C-1 INDEX OF WASTES (Continued)

Process	Generated	Disposal	Date	Quantity	References
	Non-contact Cooling Water	Discharged to Las Vegas Wash via the Beta Ditch and to the Alpha Ditch or Pittman by-pass pipeline	1945-Present	up to 4 million gallons per day during summer	K037, K158A
Steam Plant	Wastewater (with concentrated dissolved solids)	Unlined BMI ponds via Beta Ditch	1945-1976	NR/NC	K037, K158A, K338
		Lined KMCC Pond C-1 Wastewater Treatment Plant	1974-1989 1989-Present	NR/NC NR/NC	K031, K117, K158A K031, K117, K158A
		Lined KMCC Ponds WC-1 & WC-2	1989-Present	NR/NC	K158A, K305, K320
Waste Water Treatment Plant (Vapor Recompression Units)					
Notes:					
(1) Sodium chlorate filter cakes (moist cakes) replaced previous slurry due to process changes which were completed by February 1975.					
(2) Since January 1990, sodium chlorate filter cakes do not contain carbon as a result of process changes.					
(3) Intentional off-site disposal reportedly ceased by January 1976 (K347). The completion of various SIs occurred from approximately Spring 1972 through Fall 1975. Various production and waste stream changes and adjustments occurred during this phase-out period. Therefore, dates of SI startups and BMI pond disposal cessation are approximate only.					
(4) Manganese dioxide tailings consist of damp filter cake since completion of process modifications in 1975.					
(5) Prior to enactment of RCRA, documentation of discharge pH may not have occurred. Following RCRA enactment, pH of discharge is documented.					
(6) No prior information or documented releases.					
NR/NC - Quantity not researched/not calculated by Kleinfelder.					
ND - Quantity not documented by KMCC or others.					

Order@enviroincorp.com, 29-Dec-18:20

APPENDIX D
INDEX OF SWMUs AND AREAS OF KNOWN OR
SUSPECTED RELEASES OR SPILLS

Appendix D contains the following information:

1. Index of KMCC Solid Waste Management Units (SWMUs); and
2. Index of Known or Suspected KMCC Releases or Spills.

The Index of KMCC SWMUs lists the following information:

- o The report section that addresses each SWMU;
- o The SWMU number; and
- o The SWMU name.

The Index of Known or Suspected KMCC Releases or Spills lists the following information:

- o The report section that addresses the release or spill; and
- o The spill/release designation.

APPENDIX D
INDEX OF KMCC SWMUs

<u>Section</u>	<u>SWMU Number</u>	<u>SWMU Name</u>
5.1	<u>KMCC-001 (MAP 1)</u>	- "Process Hardware" Storage Area Between Units 1 and 2
5.2	<u>KMCC-002 (MAP 2)</u>	- Trash Storage Area North of Units 1 and 2
5.3	<u>KMCC-003 (MAP 3)</u>	- PCB Storage Area - Unit 2
5.4	<u>KMCC-004 (MAP 4)</u>	- Hazardous Waste Storage Area North of Unit 2
5.5	<u>KMCC-005 (MAP 5)</u>	- Sodium Chlorate Filter Cake Holding Area North of Unit 3
5.6	<u>KMCC-006 (MAP 6)</u>	- Hazardous Waste Storage Area Between Units 3 and 4
5.7	<u>KMCC-007 (MAP 7)</u>	- Platinum Drying Unit North of Unit 4
5.8	<u>KMCC-008 (MAP 8)</u>	- Solid Waste Dumpsters
5.9	<u>KMCC-009 (MAP 9)</u>	- Manganese Tailings Area
5.10	<u>KMCC-010 (MAP 10)</u>	- Old P-2 Surface Impoundment
5.11	<u>KMCC-011 (MAP 11)</u>	- C-1 Surface Impoundment
5.12	<u>KMCC-012 (MAP 12)</u>	- Mn-1 Surface Impoundment
5.13	<u>KMCC-013 (MAP 13)</u>	- Hazardous Waste Landfill (Closed)
5.14	<u>KMCC-014 (MAP 14)</u>	- Trade Effluent Settling Ponds (U.S. Government Operations)
5.15	<u>KMCC-015 (MAP 15)</u>	- WC-1 (WC-West) Surface Impoundment
5.16	<u>KMCC-016 (MAP 16)</u>	- WC-2 (WC-East) Surface Impoundment
5.17	<u>KMCC-017 (MAP 17)</u>	- Ammonium Perchlorate (AP) Area - Pad 35
5.18	<u>KMCC-018 (MAP 18)</u>	- Drum Crushing Area
5.19	<u>KMCC-019 (MAP 19)</u>	- Groundwater Remediation Unit
5.20	<u>KMCC-020 (MAP 20)</u>	- The Beta Ditch
5.21	<u>KMCC-021 (MAP 21)</u>	- Sodium Perchlorate Platinum By-Product Filter - Unit 5
5.22	<u>KMCC-022 (MAP 22)</u>	- Former Manganese Tailings Area

APPENDIX D
INDEX OF KMCC SWMUs (Continued)

<u>Section</u>	<u>SWMU Number</u>	<u>SWMU Name</u>
5.23	<u>KMCC-023 (Map 23)</u>	- Closed Surface Impoundment S-1
5.24	<u>KMCC-024 (Map 24)</u>	- Closed Surface Impoundment P-1
5.25	<u>KMCC-025 (Map 25)</u>	- Truck Emptying/Dump Site
5.26	<u>KMCC-026 (Map 26)</u>	- Former Satellite Accumulation Point - Unit 3, Maintenance Shop
5.27	<u>KMCC-027 (Map 27)</u>	- Former Satellite Accumulation Point - Unit 6, Maintenance Shop
5.28	<u>KMCC-028 (Map 28)</u>	- Satellite Accumulation Point - AP Laboratory
5.29	<u>KMCC-029 (Map 29)</u>	- Satellite Accumulation Point - AP Maintenance Shop
5.30	<u>KMCC-030 (Map 30)</u>	- Storm Sewer System
5.31	<u>KMCC-031 (Map 31)</u>	- Acid Drain System

APPENDIX D
INDEX OF KNOWN OR SUSPECTED KMCC RELEASES OR SPILLS

<u>Section</u>	<u>Spill/Release Designation</u>
6.1	PCB Transformers
6.2	Unit 1 Tenants - Stains
6.3	Unit 2 Salt Redler
6.4	Unit 4 and Unit 5 Basements - Consent Agreement
6.5	Unit 6 Basements - Remediation Project
6.6	Diesel Storage Tank Area - Stains
6.7	Former Old Main Cooling Tower and Recirculation Lines
6.8	Leach Plant Area Manganese Ore Piles
6.9	Leach Plant Area Anolyte Tanks
6.10	Leach Plant Area Sulfuric Acid Storage Tank
6.11	Leach Plant Area Leach Tanks
6.12	Leach Plant Area Transfer Lines To/From Unit 6
6.13	AP Plant Area Screening Building, Dryer Building, and Associated Sump
6.14	AP Plant Area Tank Farm
6.15	AP Plant Area Change House/Laboratory Septic Tank
6.16	AP Plant Area Storage Pads - Fire
6.17	AP Plant Area Old Building D-1 - Wash Down
6.18	AP Plant Area New Building D-1 - Wash Down
6.19	AP Plant SIs and Transfer Lines To/From AP SIs
6.20	AP Plant Transfer Lines to Sodium Chlorate Process

holder@enviroincorp.com, 29-Dec-18:20

Unable to open <https://datasite.merrillcorp.com/bidder/servlet/tiff/800101187-420.jpg?projectId=34435&pageNumber=420&versionId=800101187&username=username&format=bw&enc=enc>.

Error: java.io.IOException:

Server returned HTTP response code: 500 for URL: https://datasite.merrillcorp.com/bidder/servlet/tiff/800101187-420.jpg?projectId=34435&pageNumber=420&versionId=800101187&username=username&format=bw&enc=enc

Error: Please make sure this file can be accessed and that it is a supported file type.

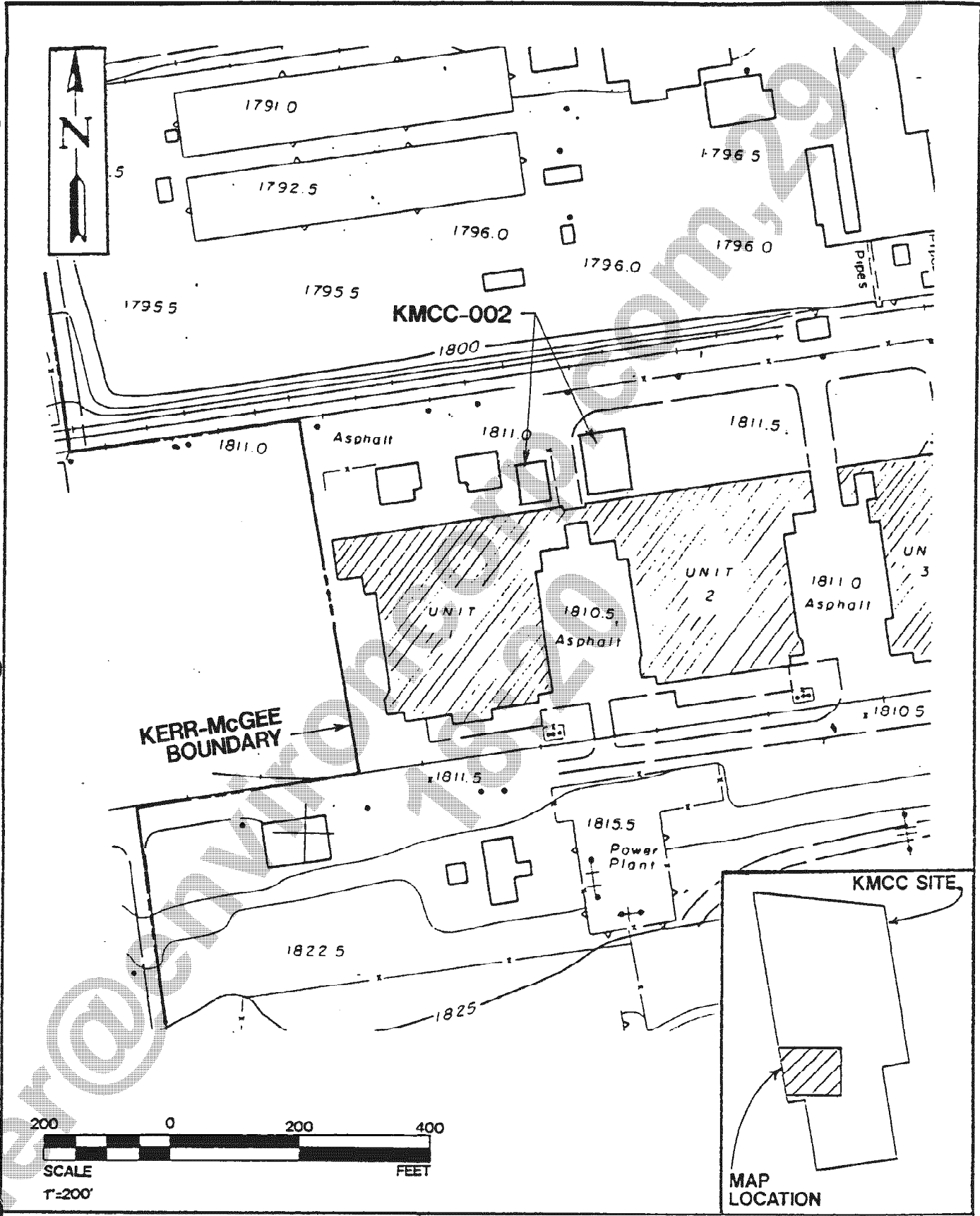

KLEINFELDER

**MAP 2: KMCC-002
TRASH STORAGE AREA**

MAP
2

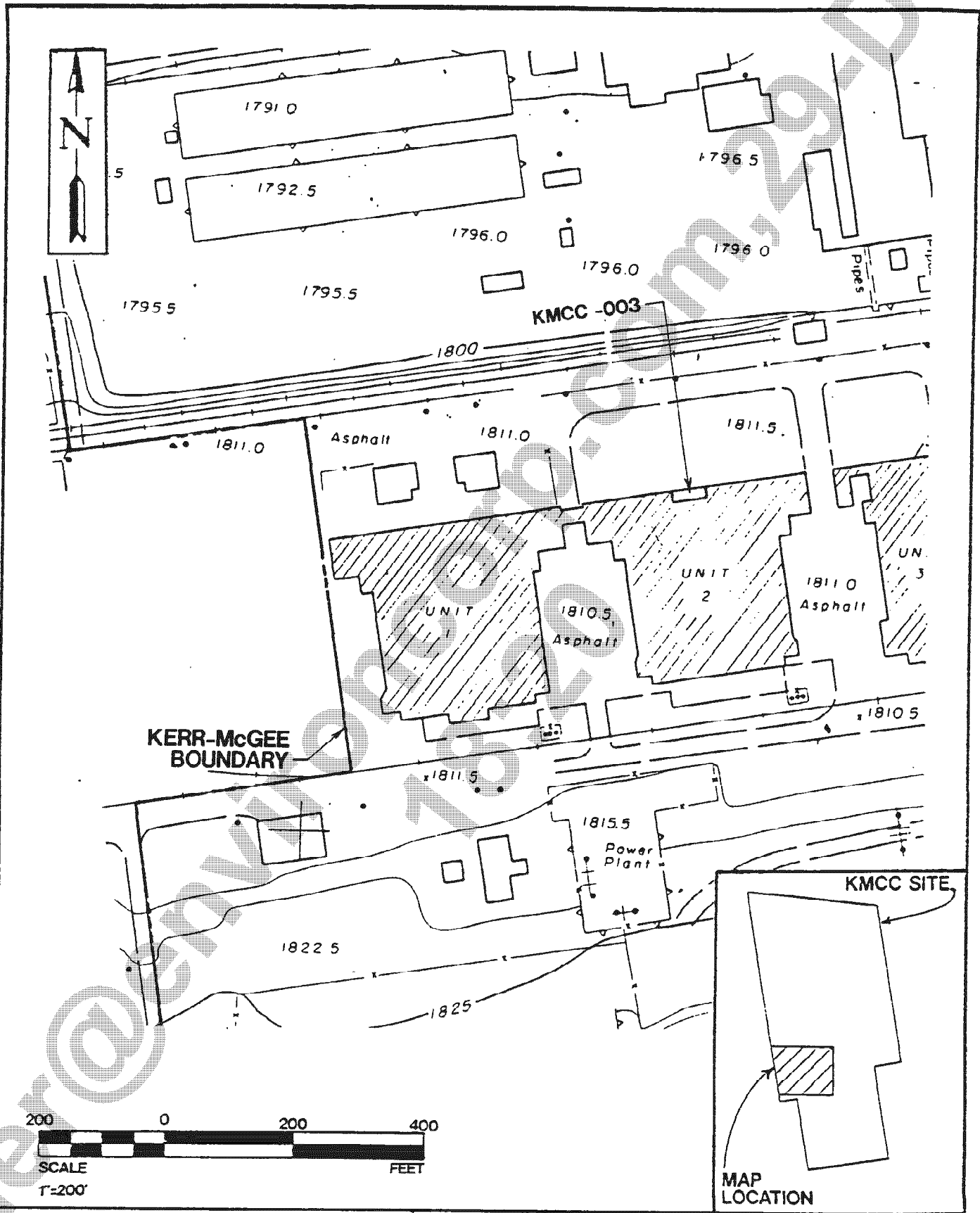

KLEINFELDER

**MAP 3: KMCC-003
PCB STORAGE AREA**

MAP

3

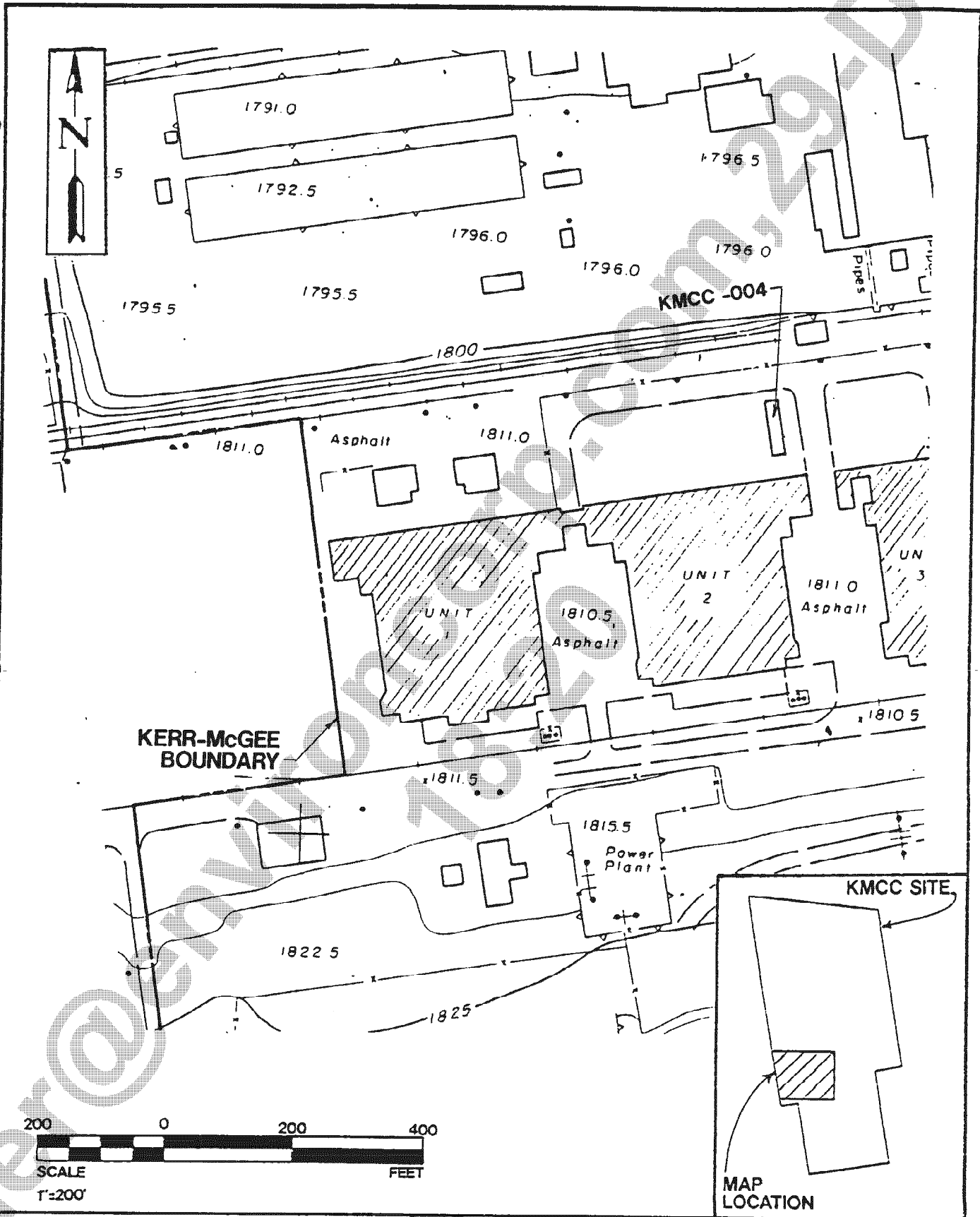

KLEINFELDER

**MAP 4: KMCC-004
HAZARDOUS WASTE
STORAGE AREA**

MAP

4

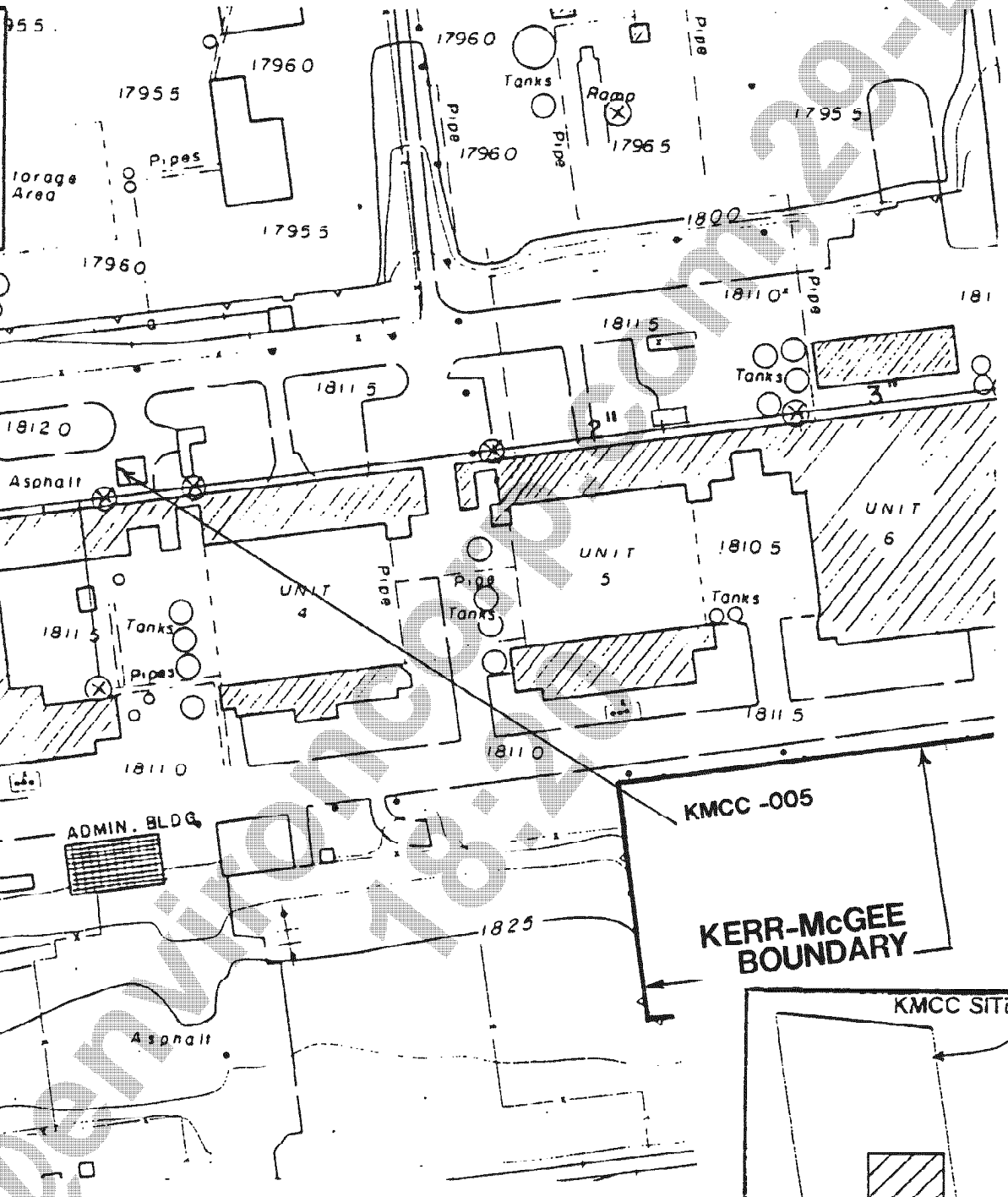

KMCC -005
KERR-McGEE
BOUNDARY

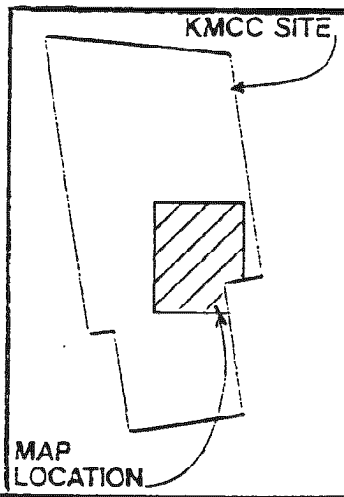

 KLEINFELDER

MAP 5: KMCC-005
SODIUM CHLORATE FILTER CAKE
HOLDING AREA NORTH OF UNIT 3

MAP
5

M-6

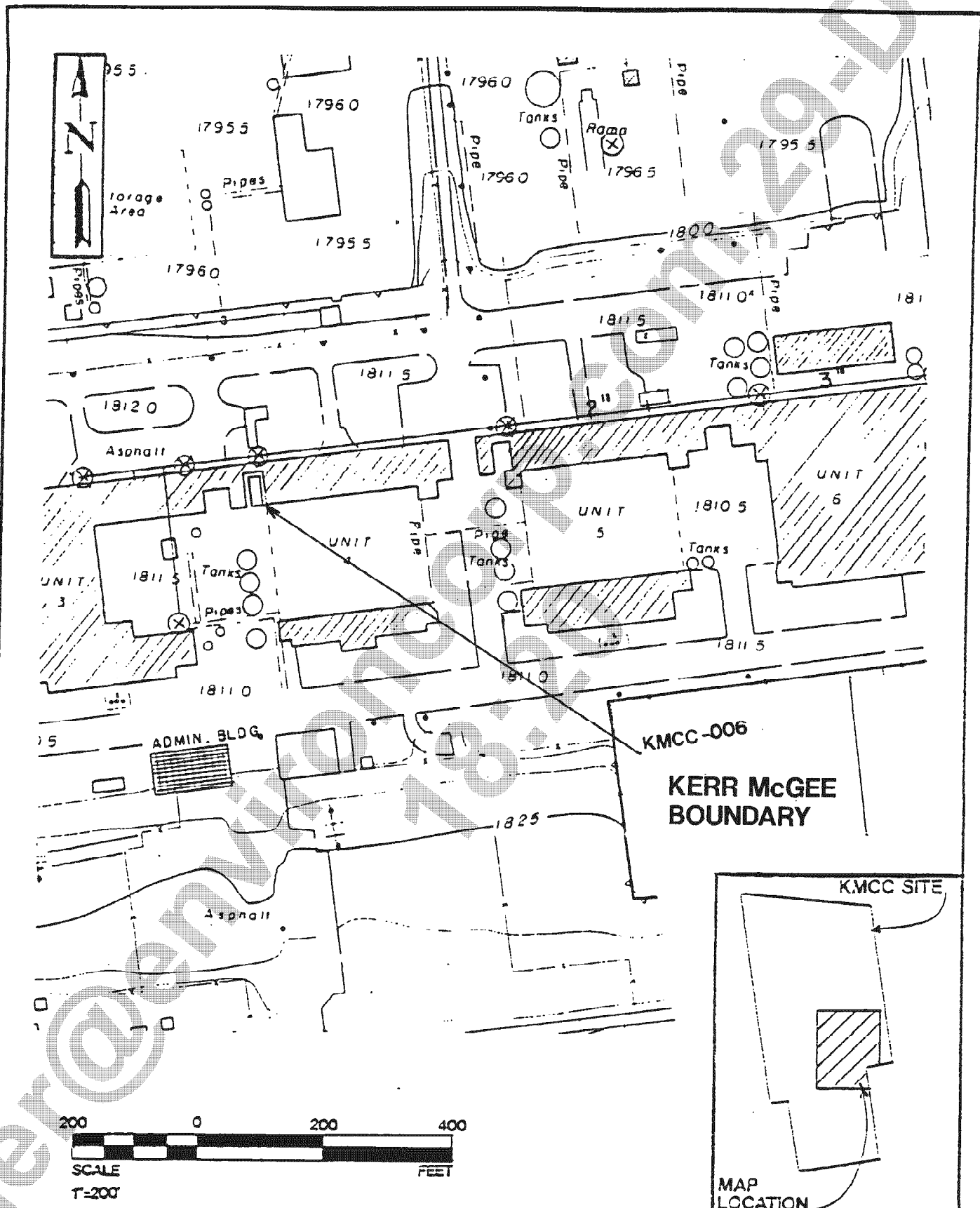

KLEINFELDER

**MAP 6: KMCC-006
HAZARDOUS WASTE STORAGE**

MAP

6

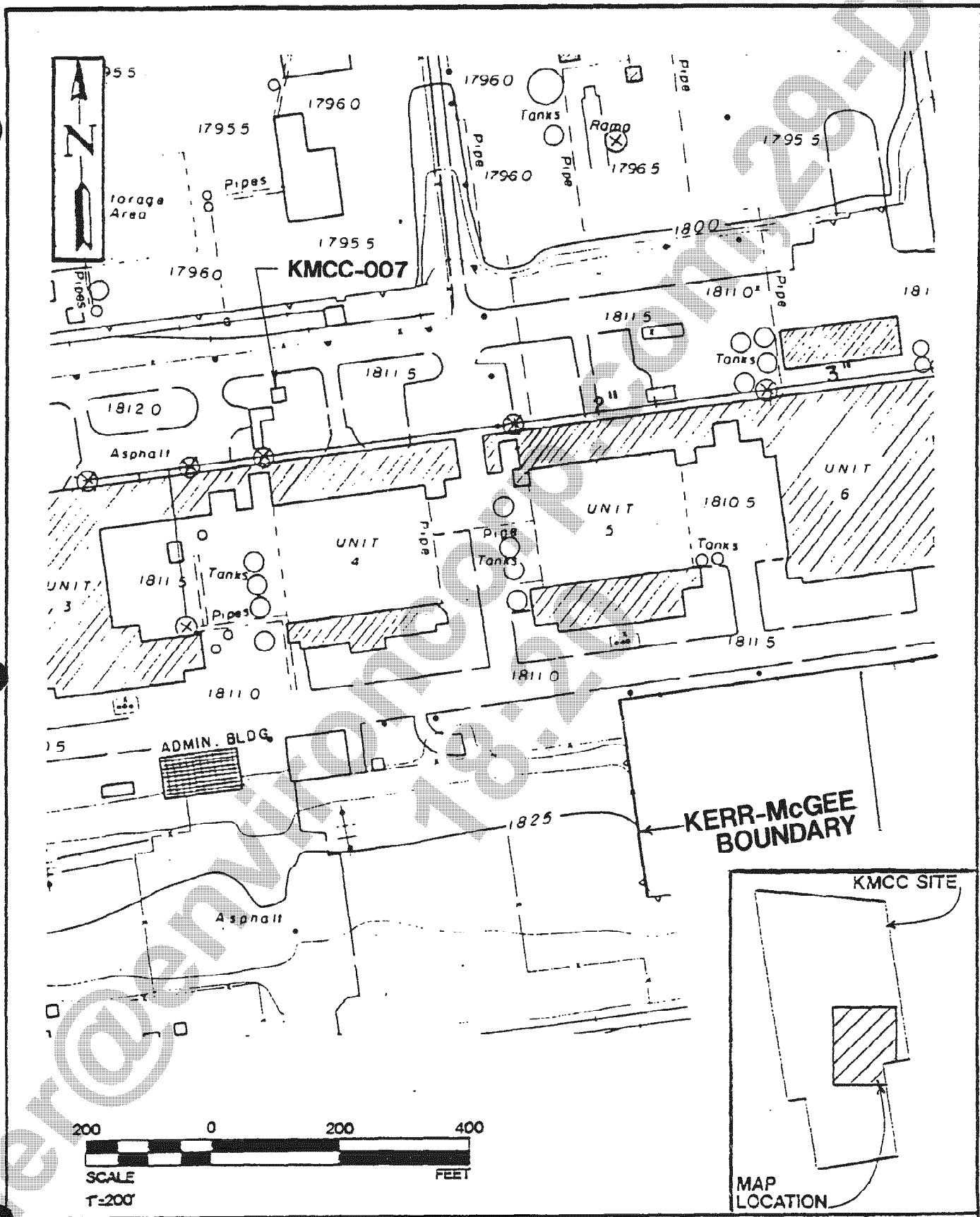

K KLEINFELDER

**MAP 7: KMCC-007
PLATINUM DRYING UNIT
NORTH OF UNIT 4**

MAP

7

35
M-2

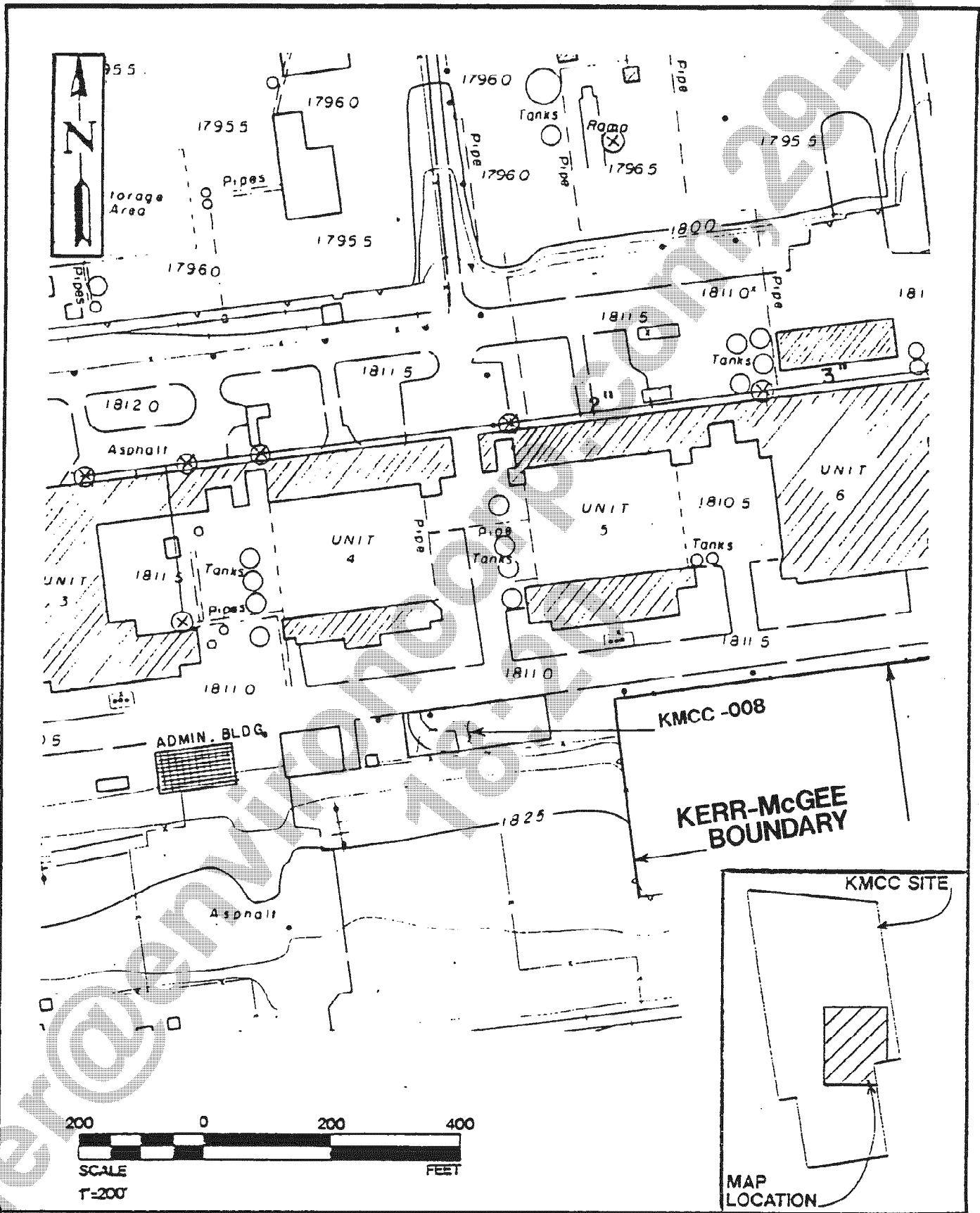

KH KLEINFELDER

**MAP 8: KMCC-008
SOLID WASTE**

MAP

8

pc
M-8

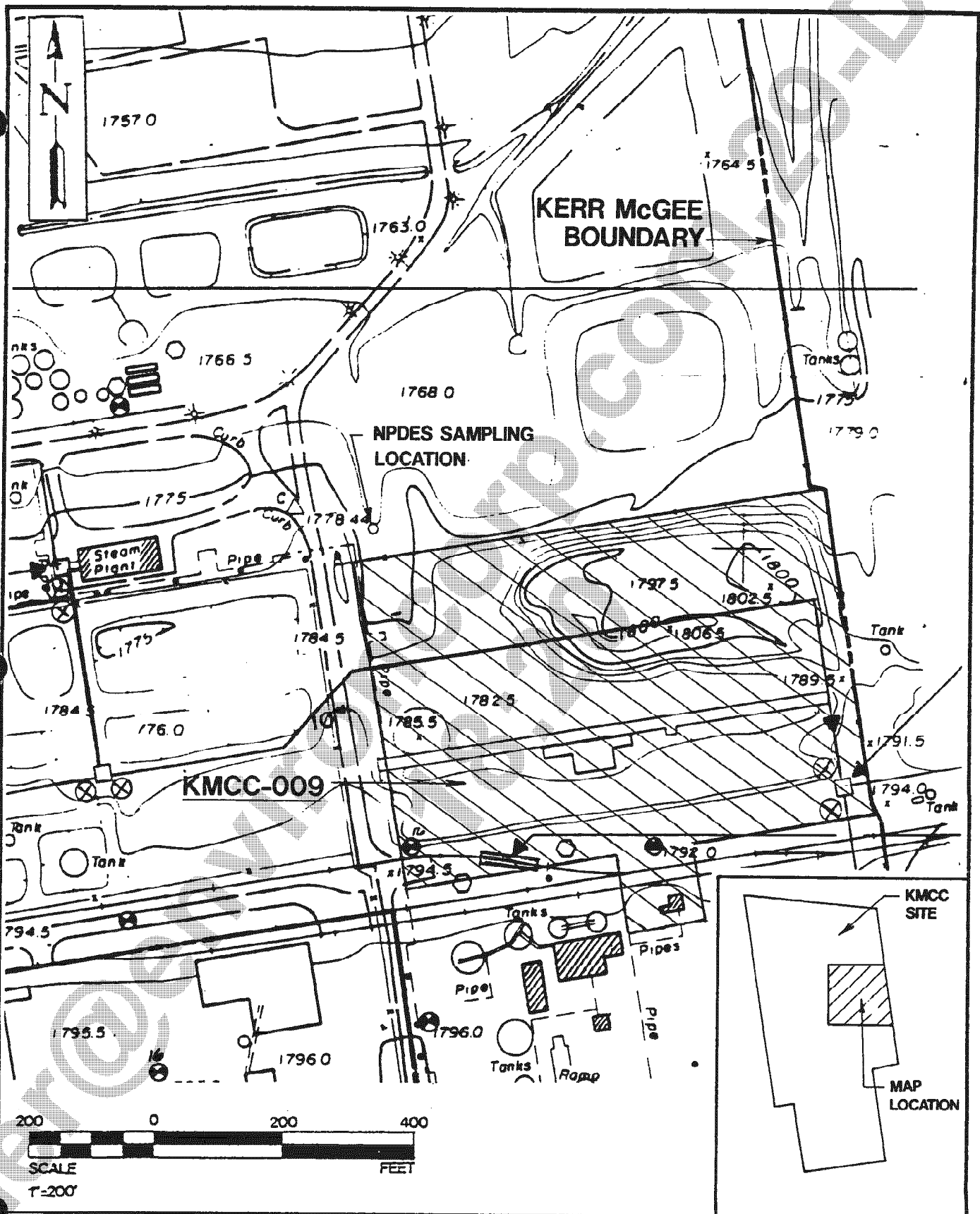

KLEINFELDER

**MAP 9: KMCC-009
MANGANESE TAILINGS AREA**

PLATE



PR
M-6

Unable to open <https://datasite.merrillcorp.com/bidder/servlet/tiff/800101187-429.jpg?projectId=34435&pageNumber=429&versionId=800101187&username=username&format=bw&enc=enc>.

Error: java.io.IOException:

Server returned HTTP response code: 500 for URL: https://datasite.merrillcorp.com/bidder/servlet/tiff/800101187-429.jpg?projectId=34435&pageNumber=429&versionId=800101187&username=username&format=bw&enc=enc

Error: Please make sure this file can be accessed and that it is a supported file type.

Unable to open <https://datasite.merrillcorp.com/bidder/servlet/tiff/800101187-430.jpg?projectId=34435&pageNumber=430&versionId=800101187&username=username&format=bw&enc=enc>.

Error: java.io.IOException:

Server returned HTTP response code: 500 for URL: https://datasite.merrillcorp.com/bidder/servlet/tiff/800101187-430.jpg?projectId=34435&pageNumber=430&versionId=800101187&username=username&format=bw&enc=enc

Error: Please make sure this file can be accessed and that it is a supported file type.

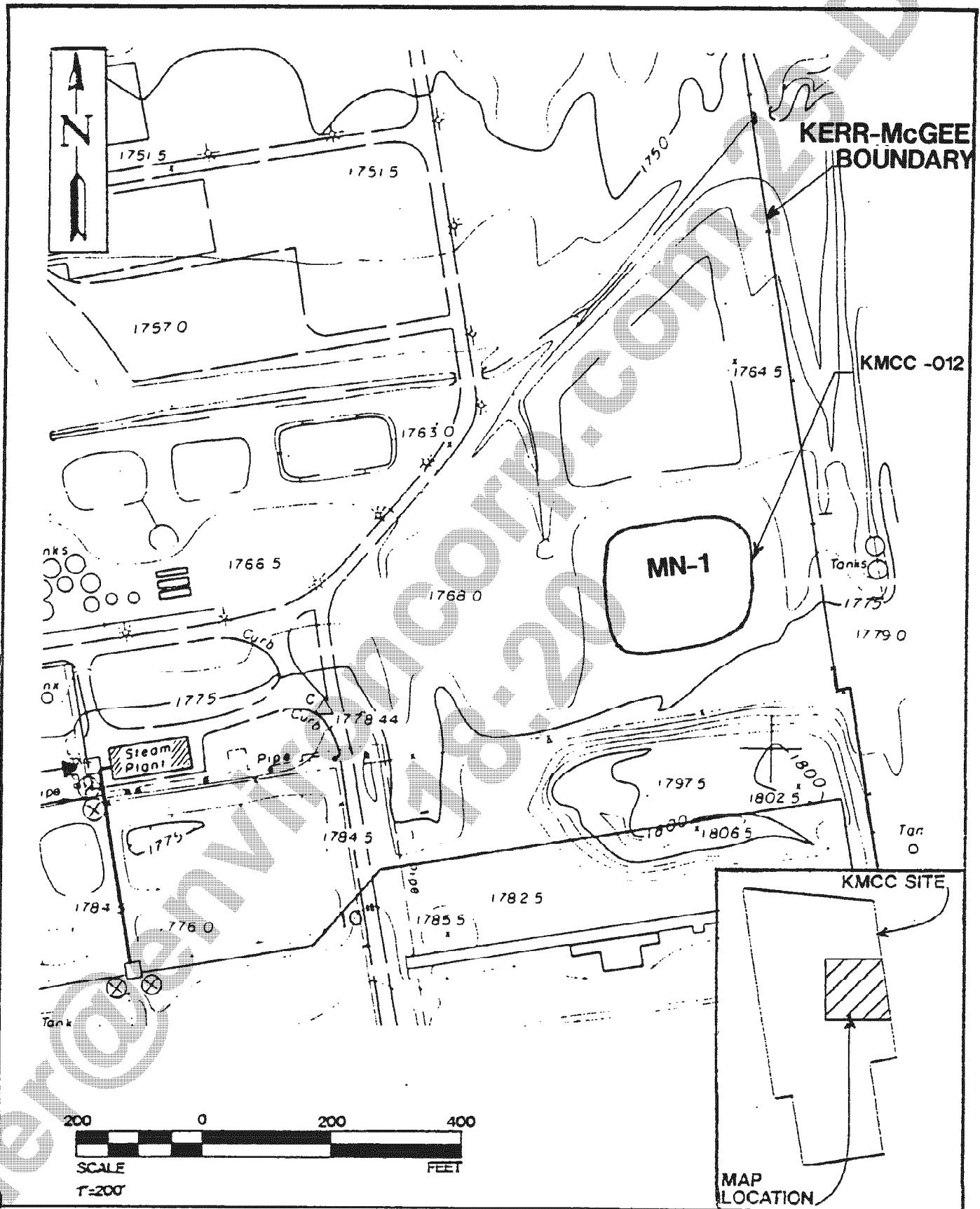

KLEINFELDER

**MAP 12: KMCC-012,
MN-1**

MAP
12

pq
M-8

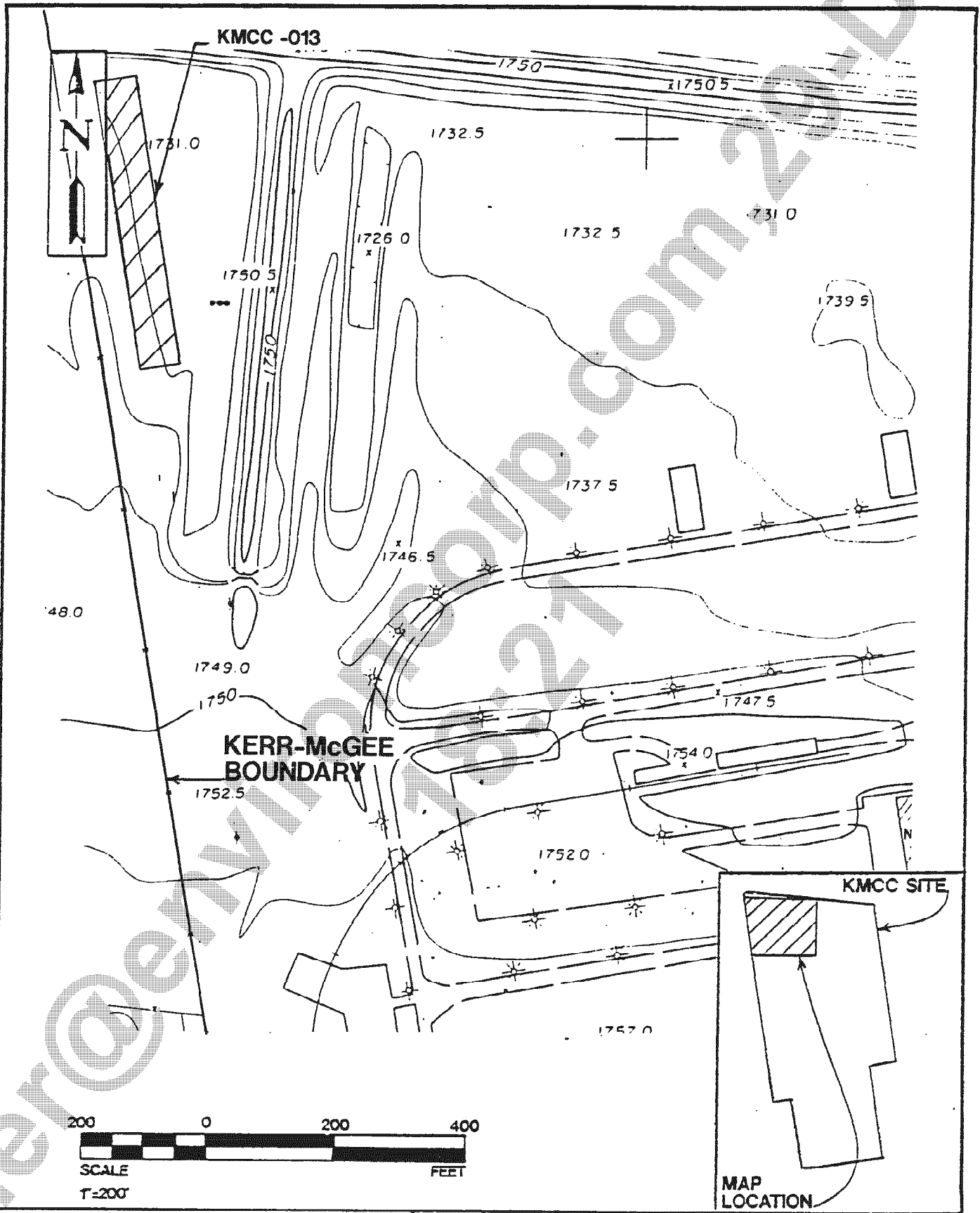

KH KLEINFELDER

MAP 13: KMCC-013

MAP

13

PR
M-6

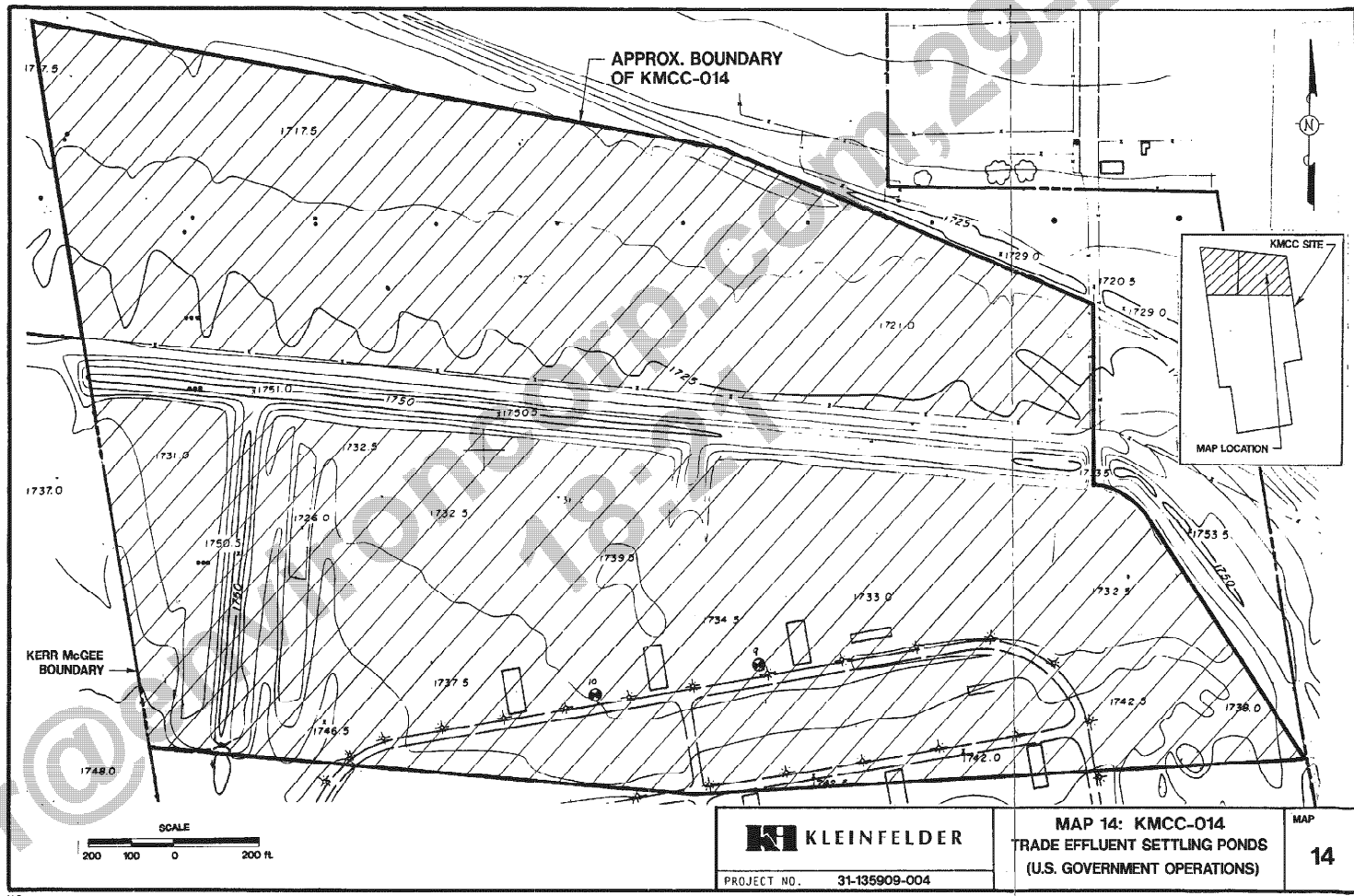

KMCC DR
 04-000836

L



KMCC -015

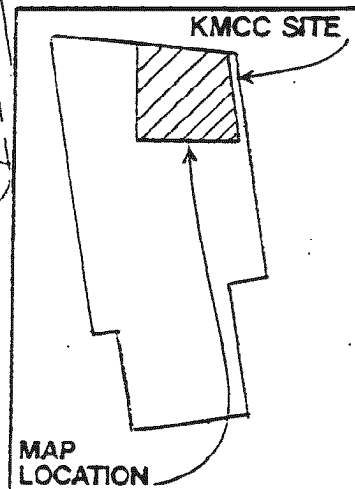
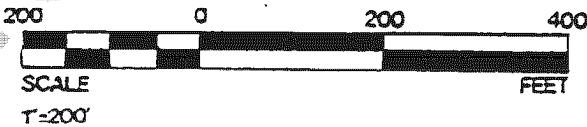
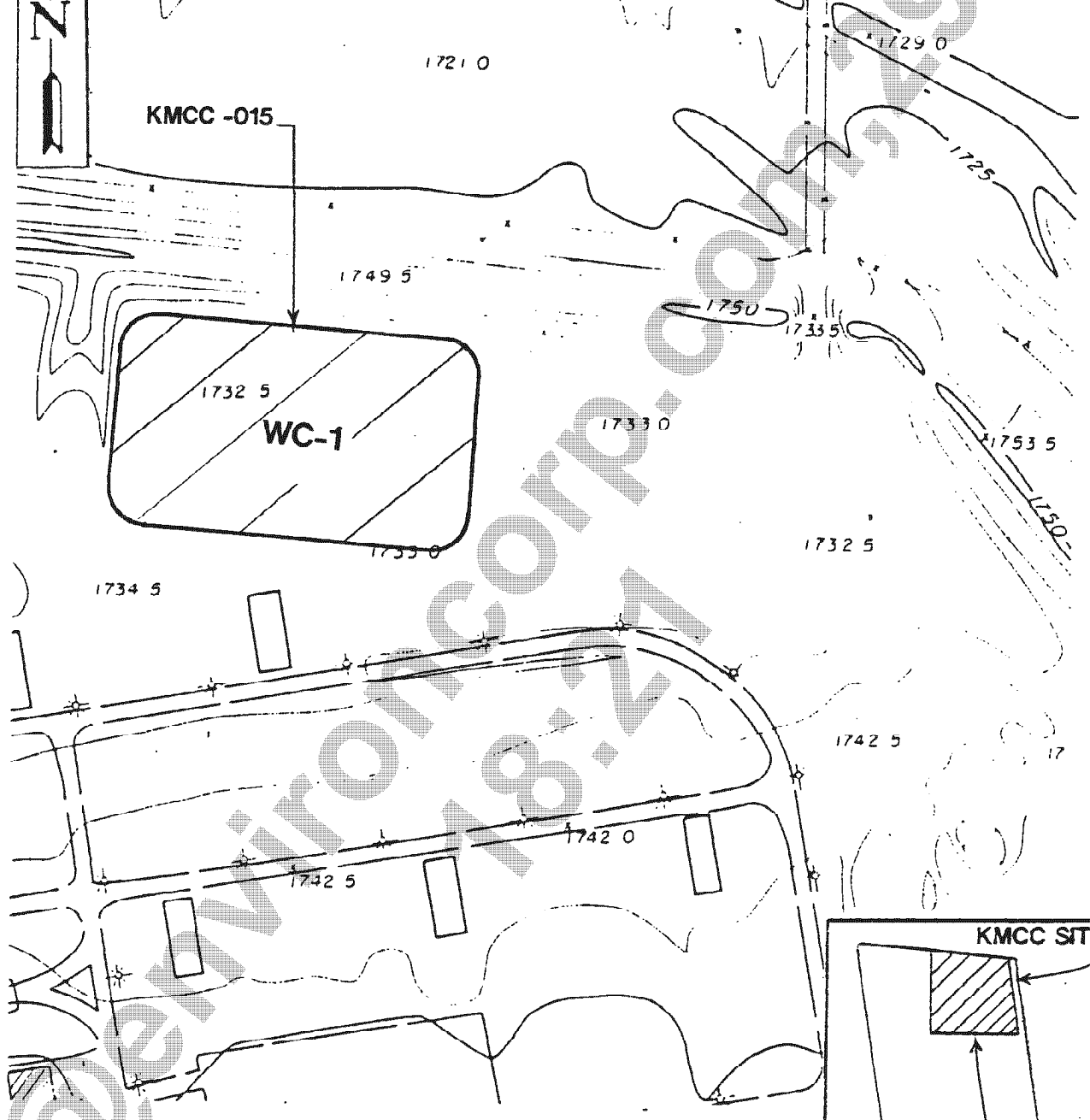
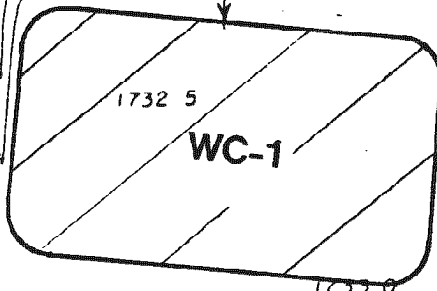

KH KLEINFELDER

**MAP 15: KMCC-015
WC-1 (WC-WEST)**

MAP

15

PC
M-1



1721 0

KMCC -016

1729 0

1749 5

1725

1732 5

1750

1733 5

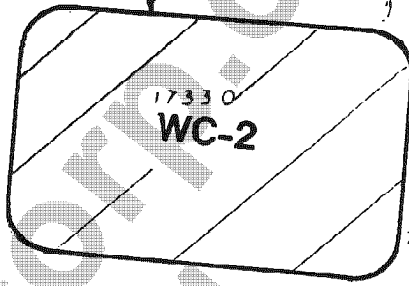

1753 5

1733 0

732 5

1734 5

1742 5

17

1742 0

1742 5

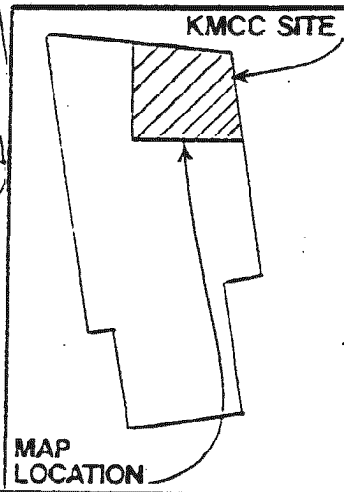

 KLEINFELDER

MAP 16: KMCC-016
WC-2 (WC-EAST)

MAP

16

PR

M-6

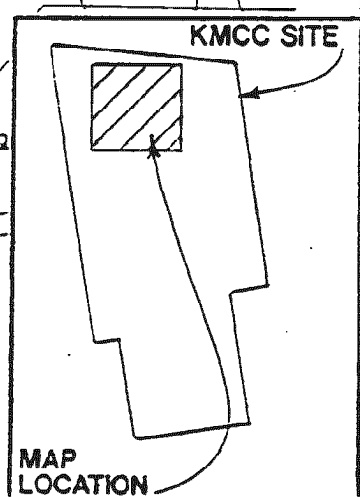
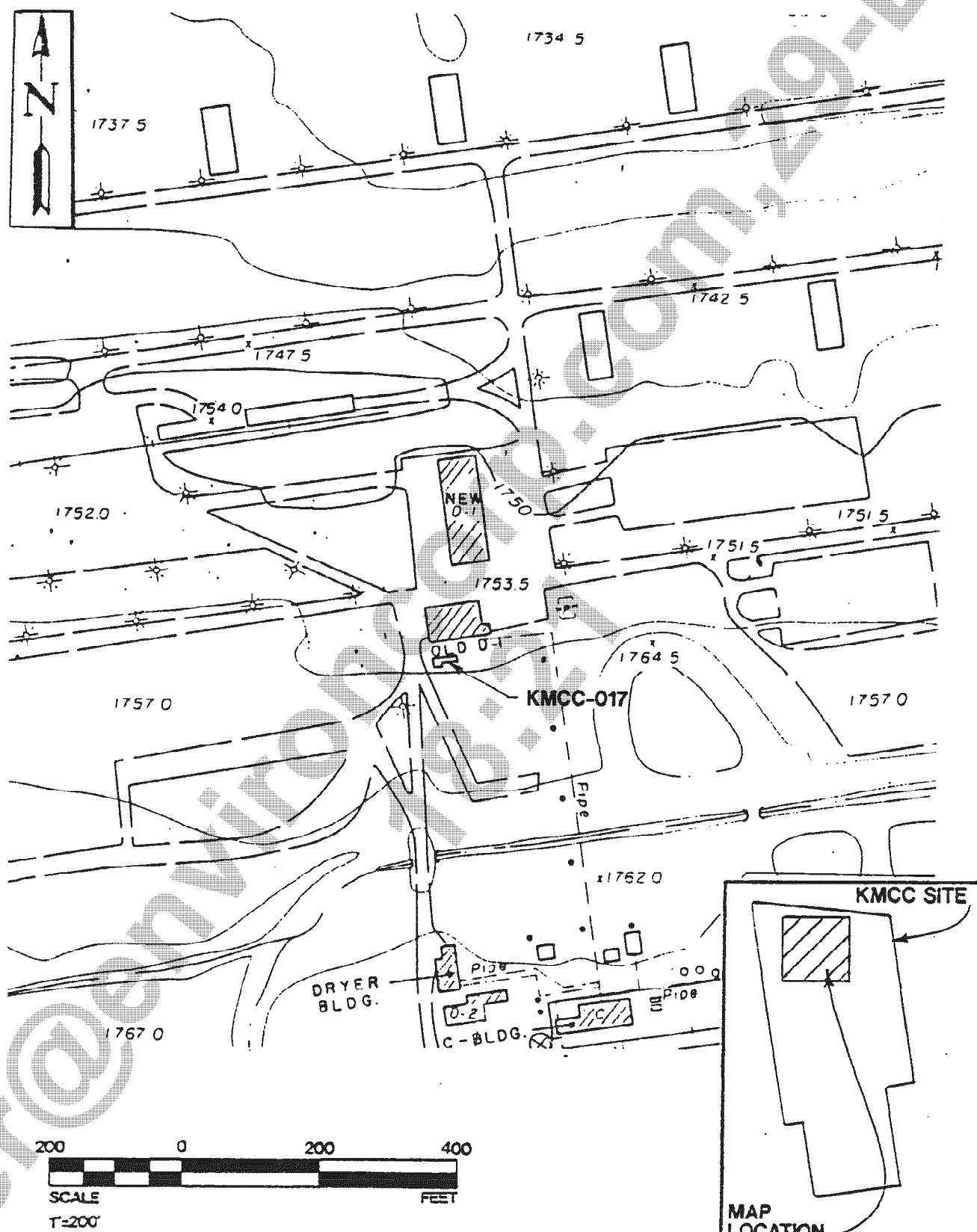

KLEINFELDER

**MAP 17: KMCC-017
AMMONIUM PERCHLORATE AREA**

MAP
17

PR
M-6

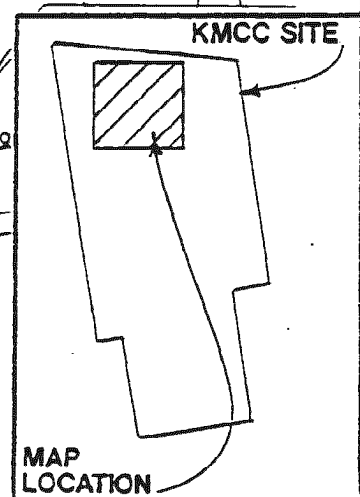
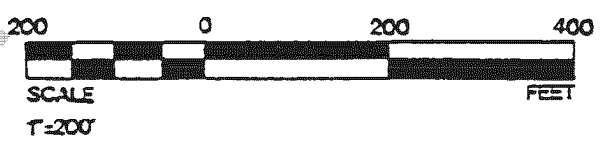
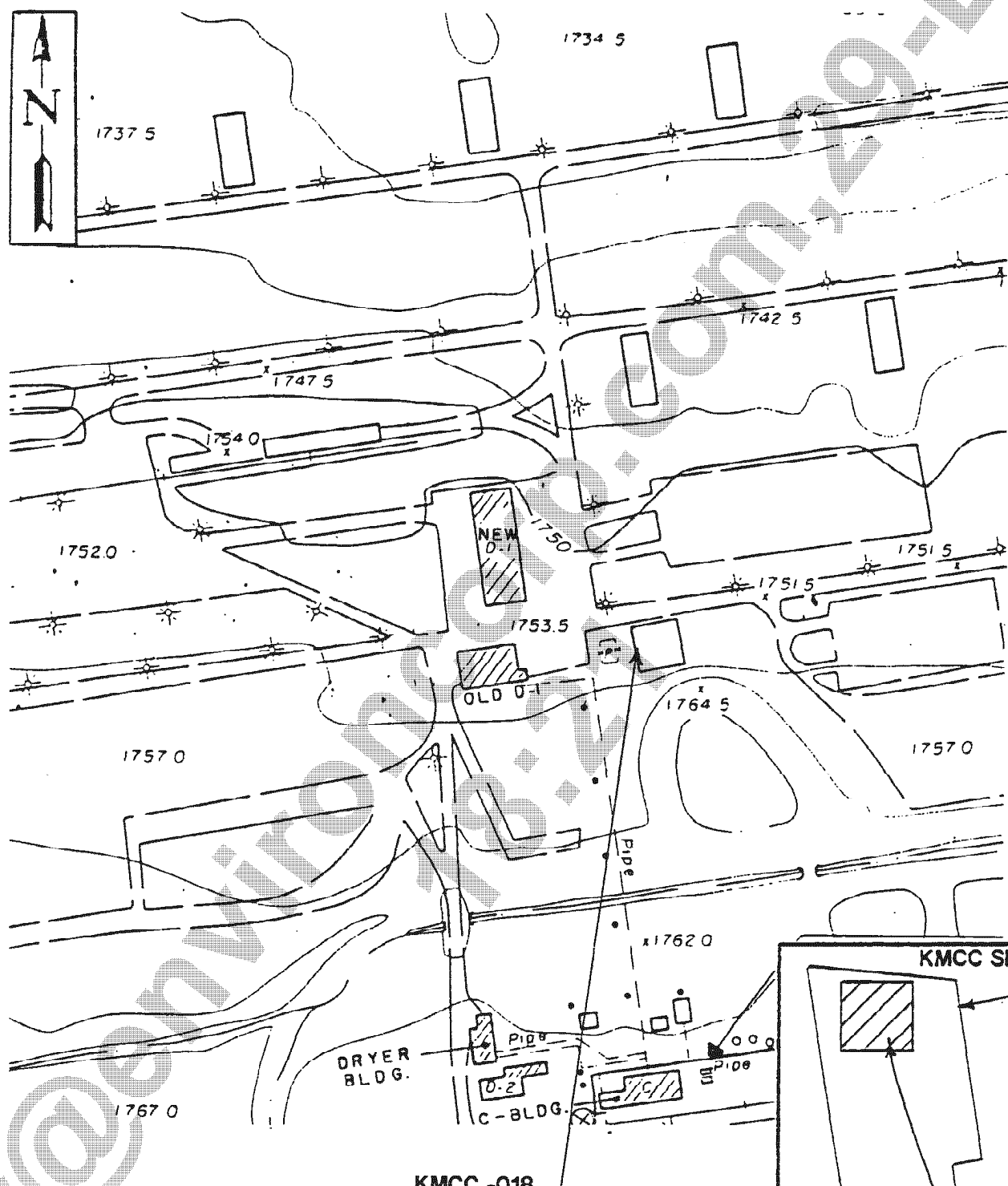

KH KLEINFELDER

MAP 18: KMCC-018
DRUM CRUSHING AREA

MAP
18

pc
M-1

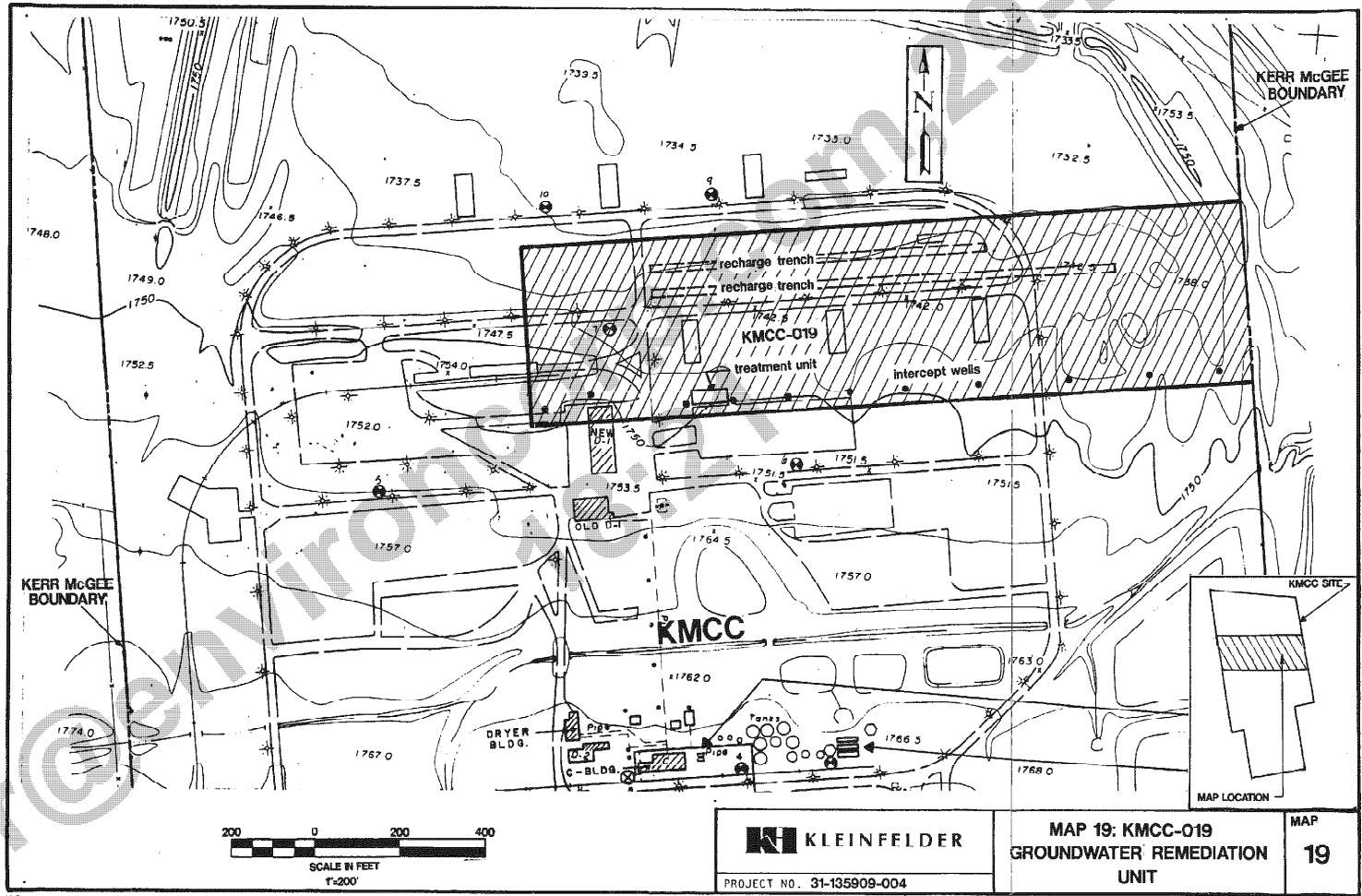

KMCC DR
 04-0008841

L

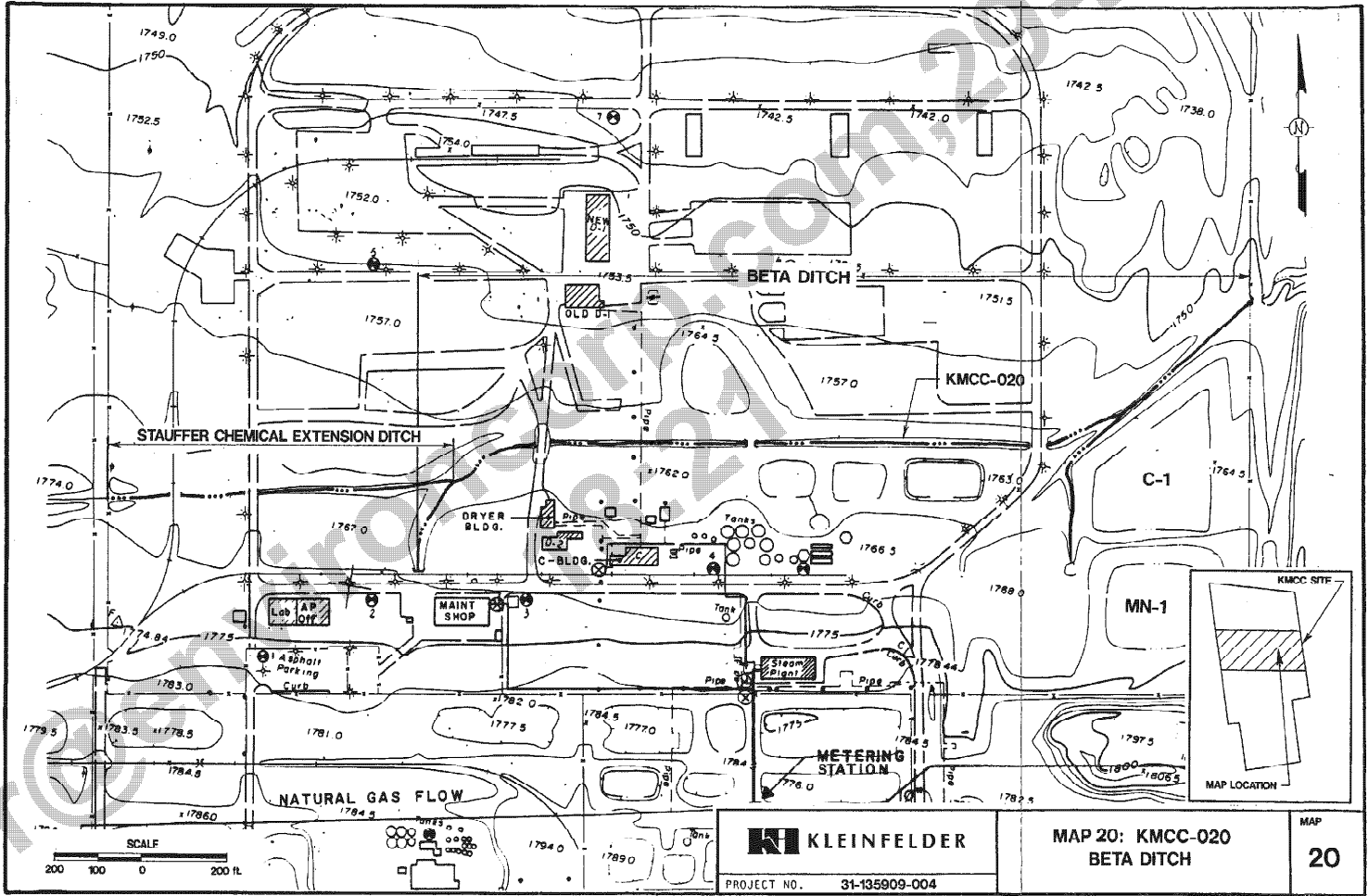

KMCC DR
 04-0008842

L

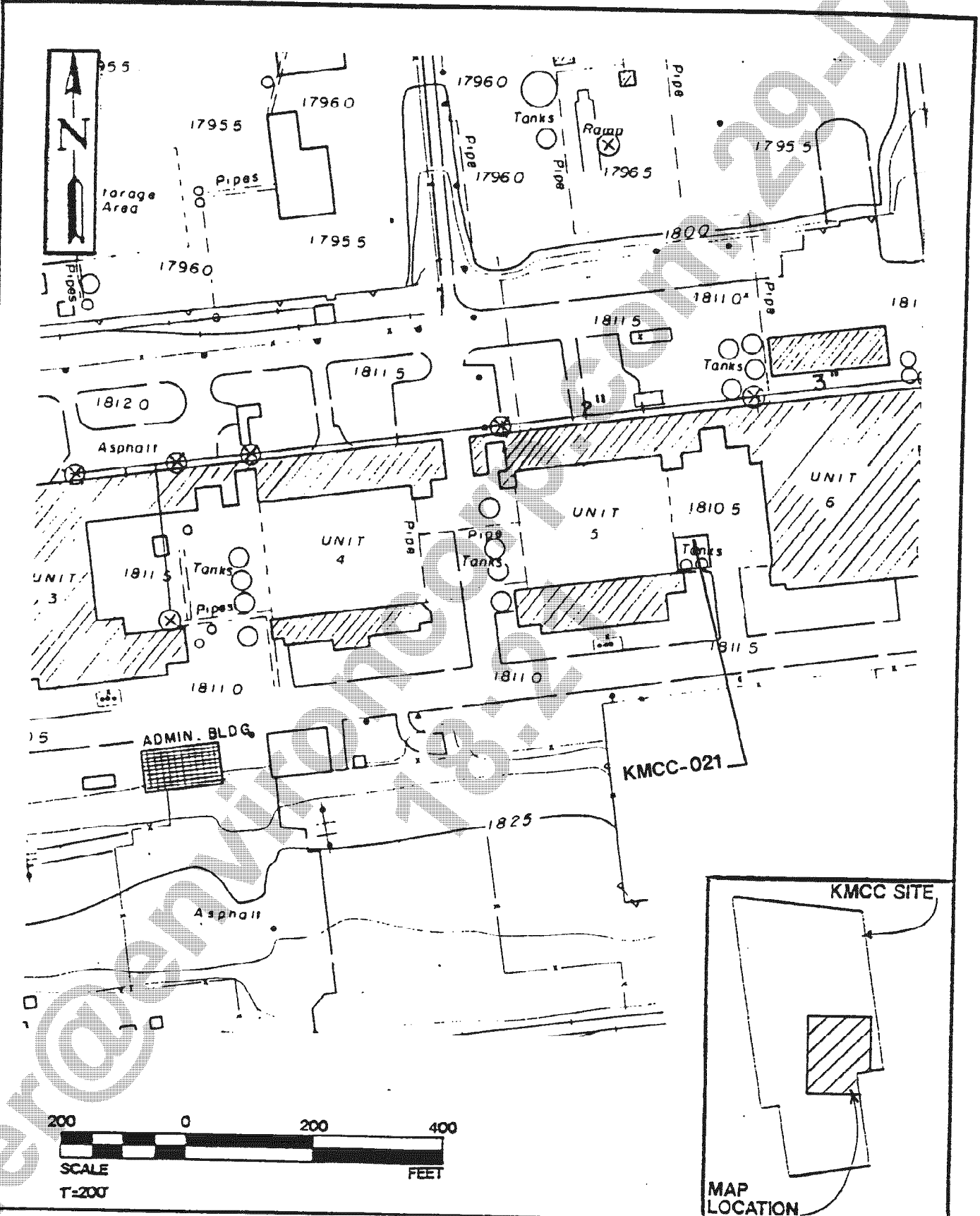



KLEINFELDER

**MAP 21: KMCC-021
SODIUM PERCHLORATE PLATINUM**

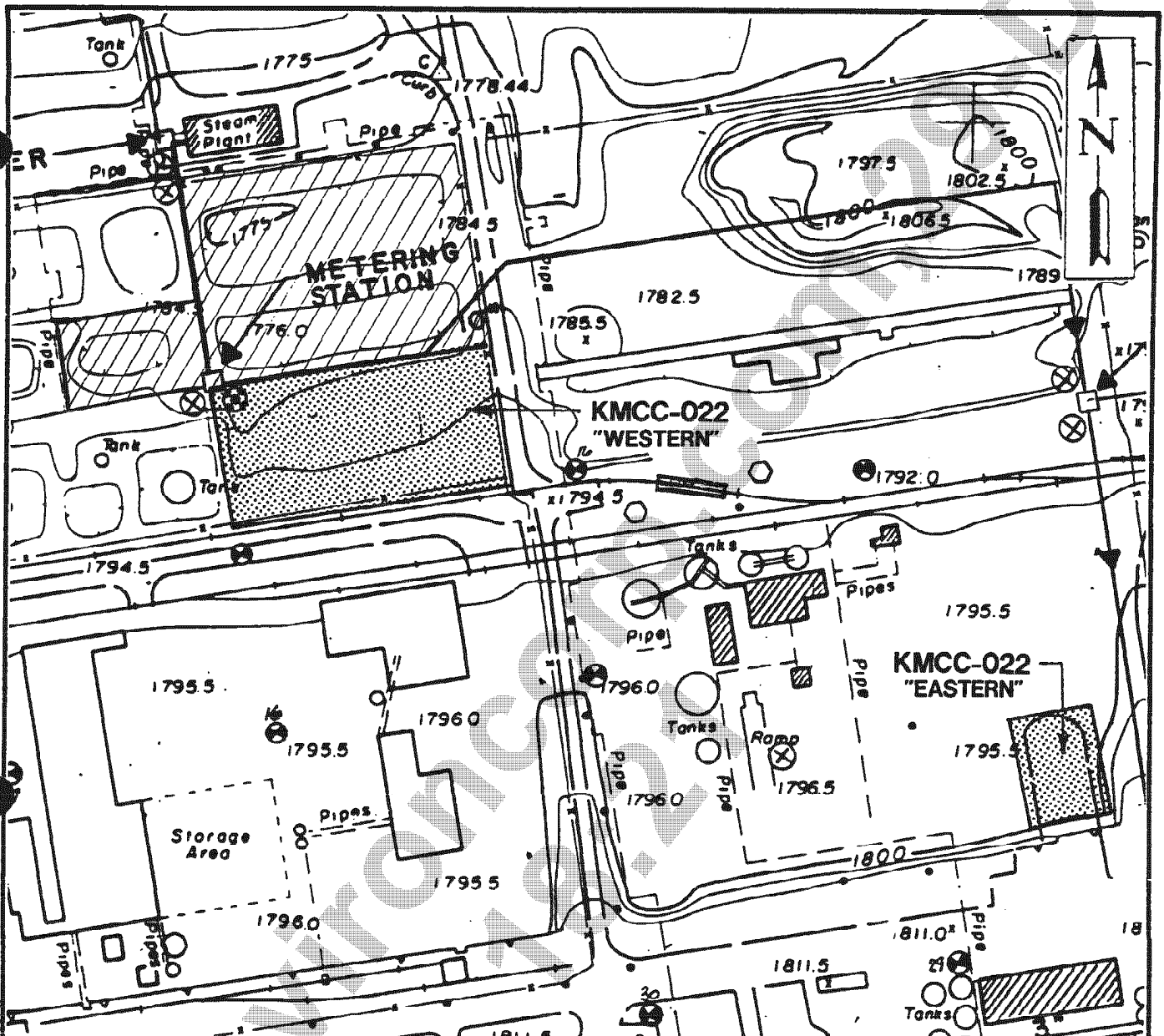
MAP
21



Legend:

-  Tailings area known from KMCC documents
-  Tailings area inferred from aerial photography and/or field observations

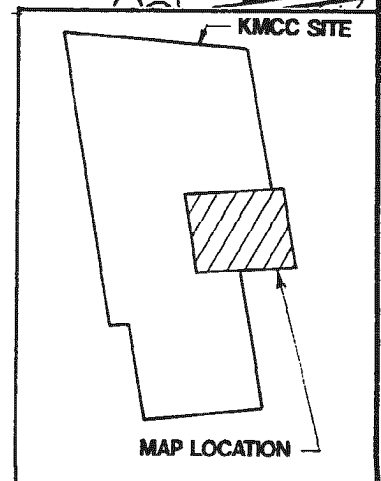
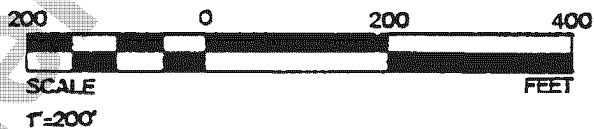

 KLEINFELDER

MAP 22: KMCC-022
FORMER MANGANESE

MAP

22

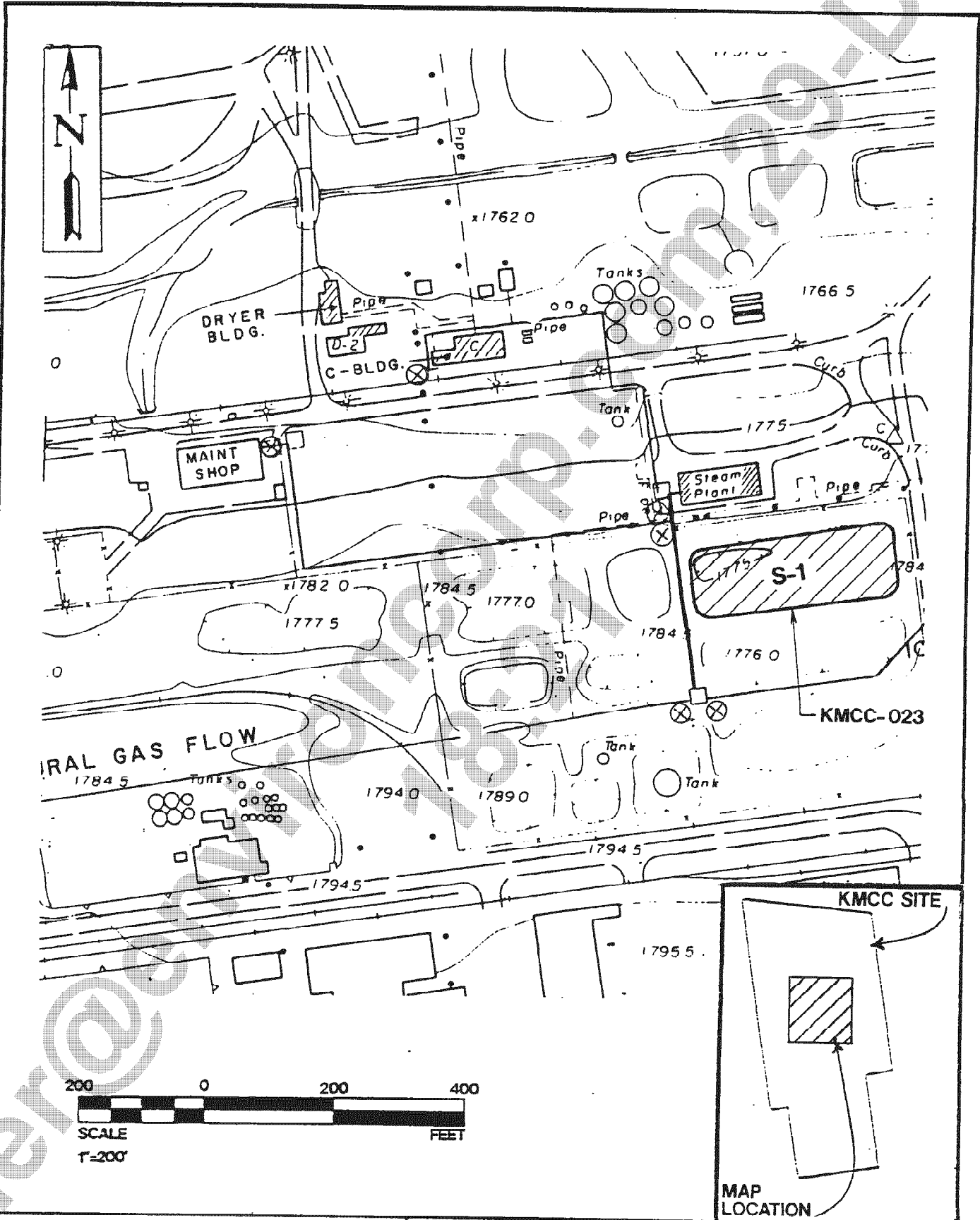

KH KLEINFELDER

**MAP 23: KMCC-023
CLOSED SURFACE**

MAP

22

PRC

M-6

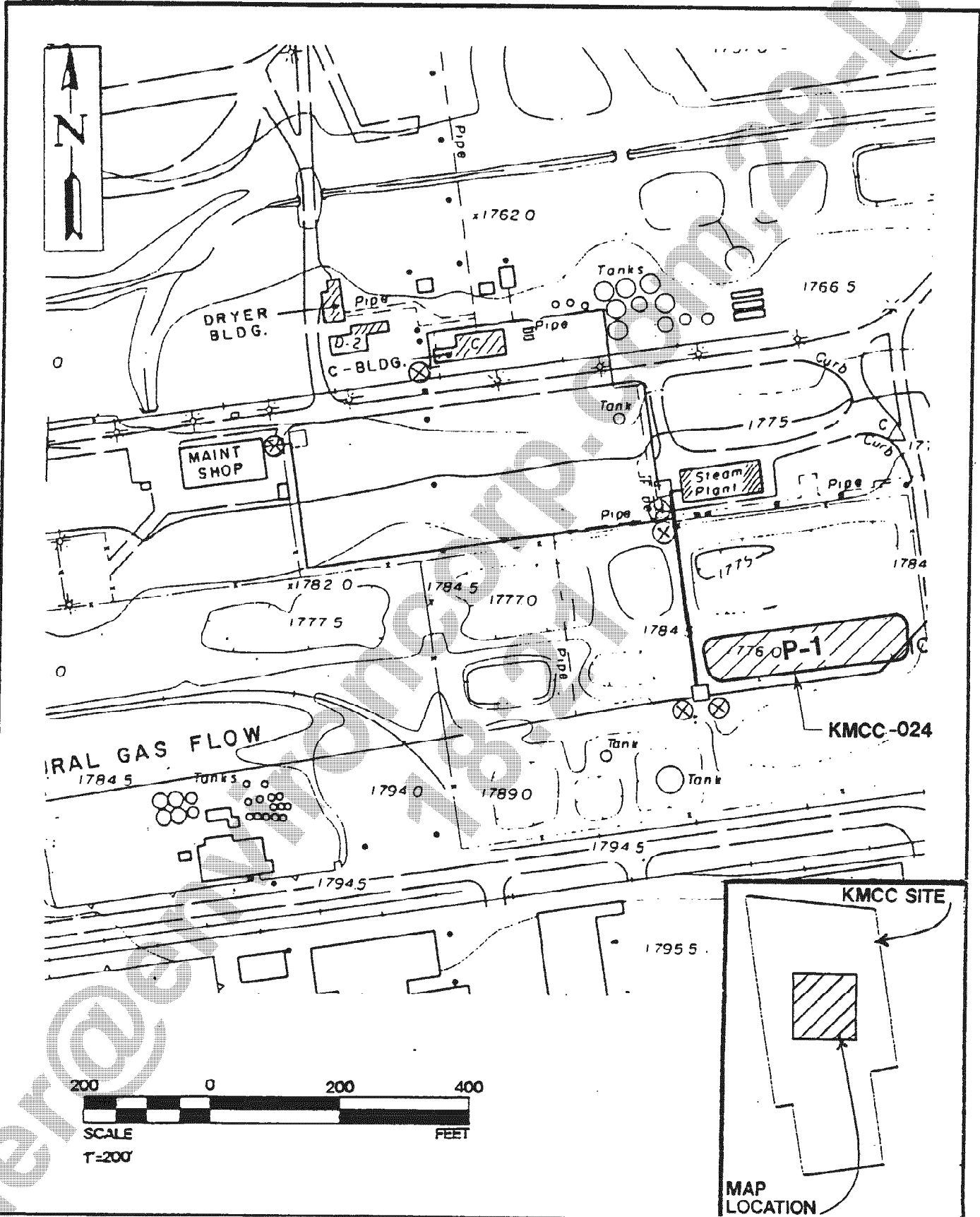

KLEINFELDER

**MAP 24: KMCC-024
CLOSED SURFACE**

MAP
24

PR
M-6

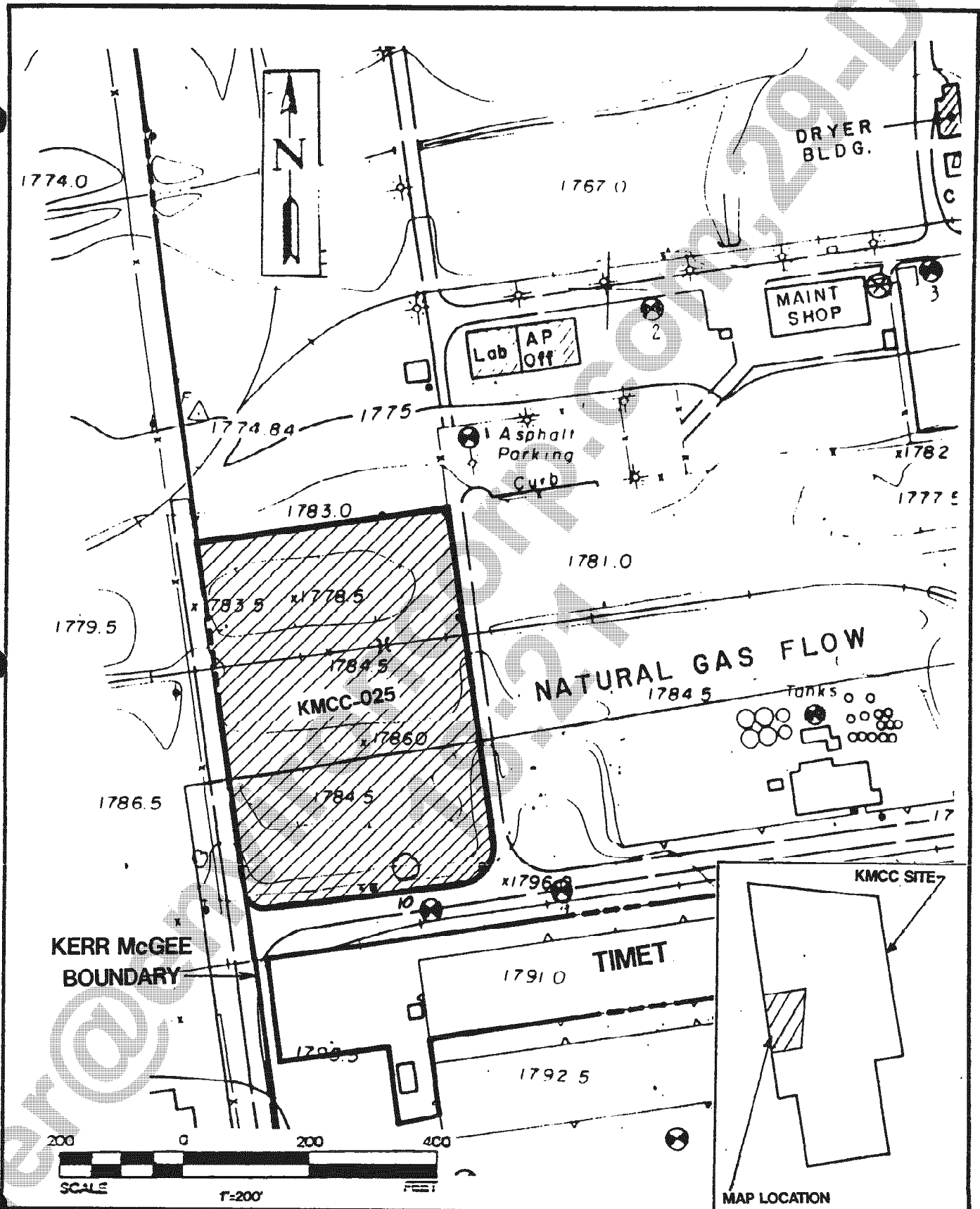

KERR McGEE
BOUNDARY

NATURAL GAS FLOW

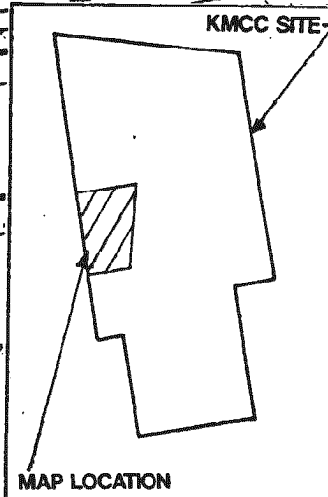
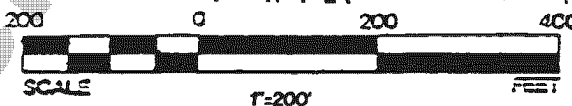

KLEINFELDER

MAP 25: KMCC-025
TRUCK EMPTYING/DUMP SITE

MAP
25

PF
M-6

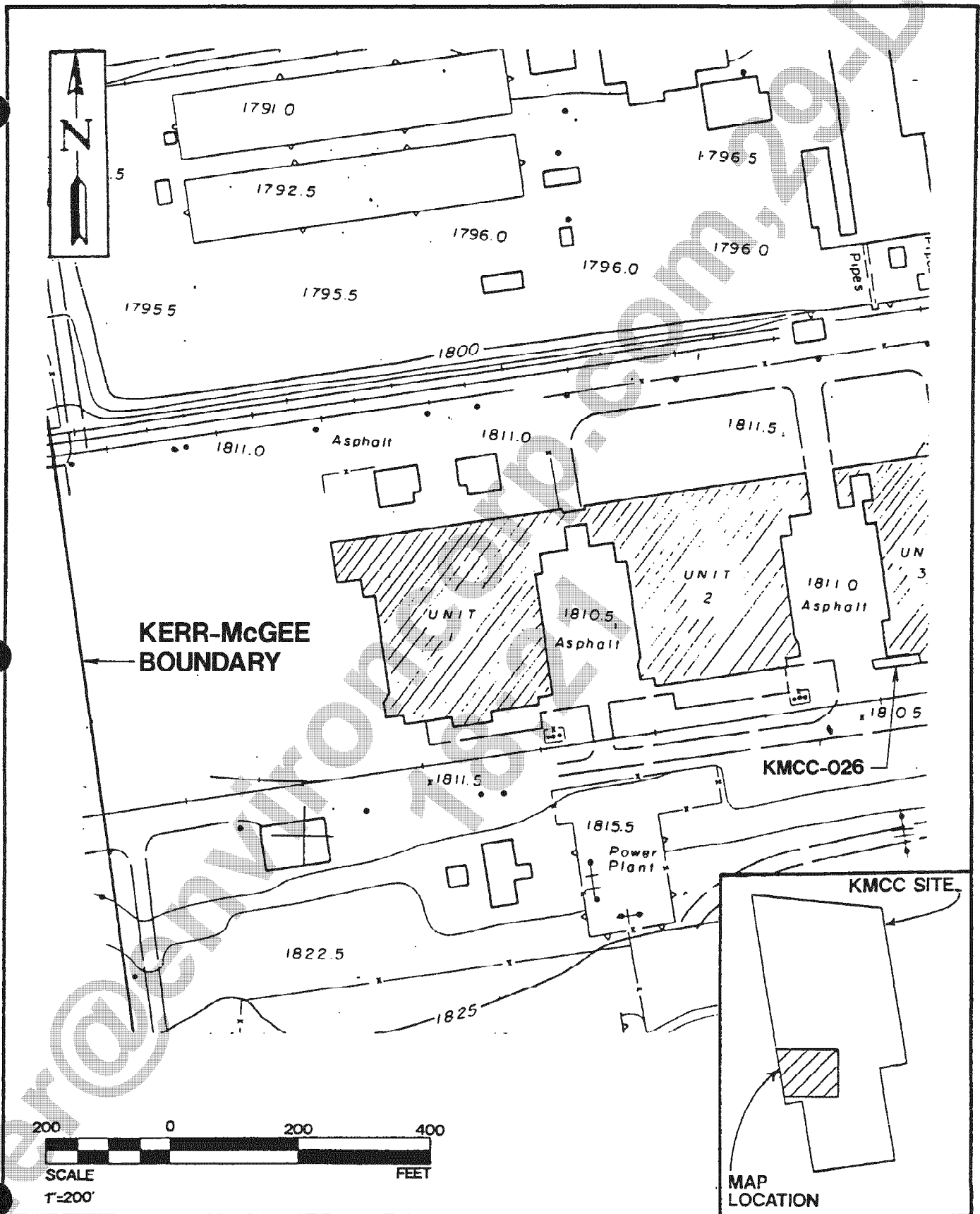

KH KLEINFELDER

MAP 26: KMCC-026
FORMER SATELLITE ACCUMULATION

PLATE
26

PF

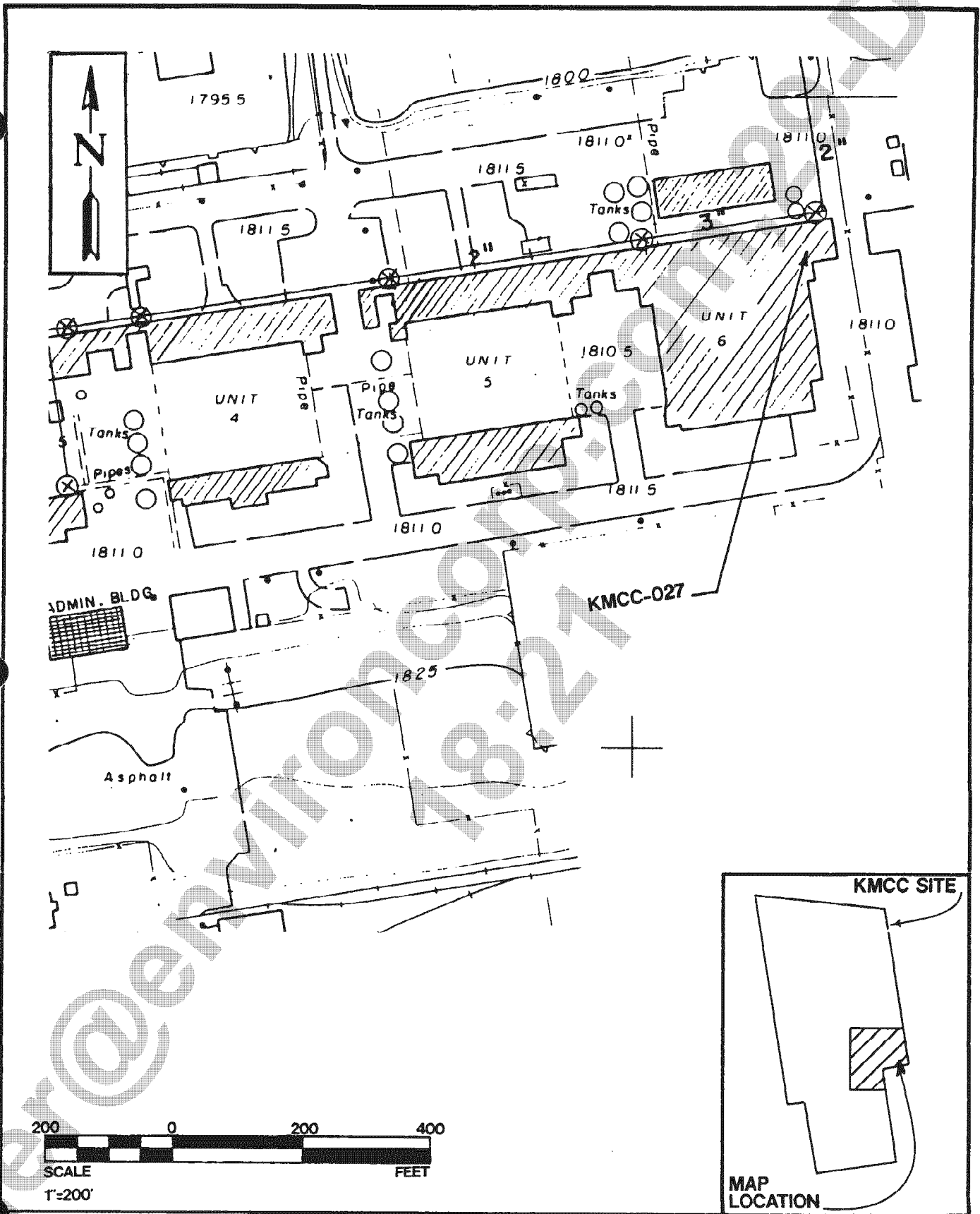

KLEINFELDER

**MAP 27: KMCC-027
FORMER SATELLITE ACCUMULATION**

MAP

27

PR
M-E

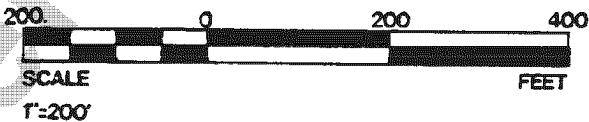
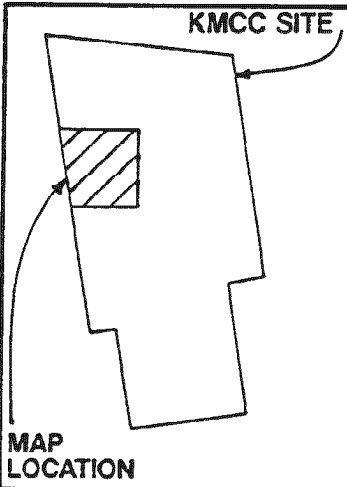
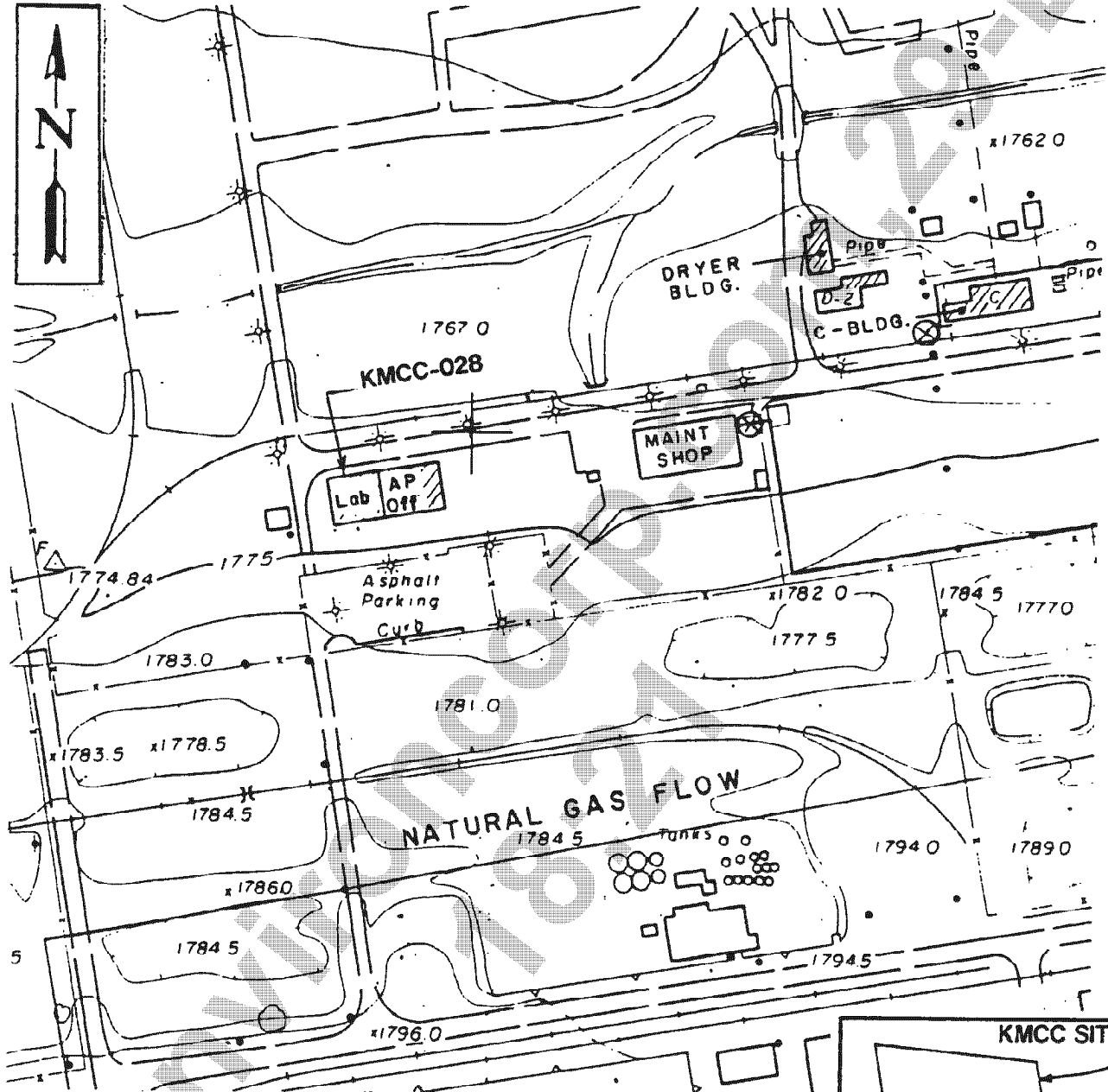

KH KLEINFELDER

MAP 28: KMCC-028

SATELLITE ACCUMULATION POINT

MAP

28

PR

M-6

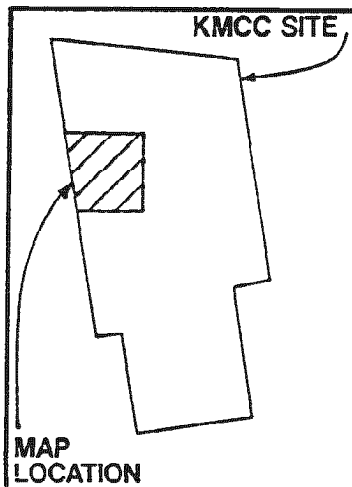
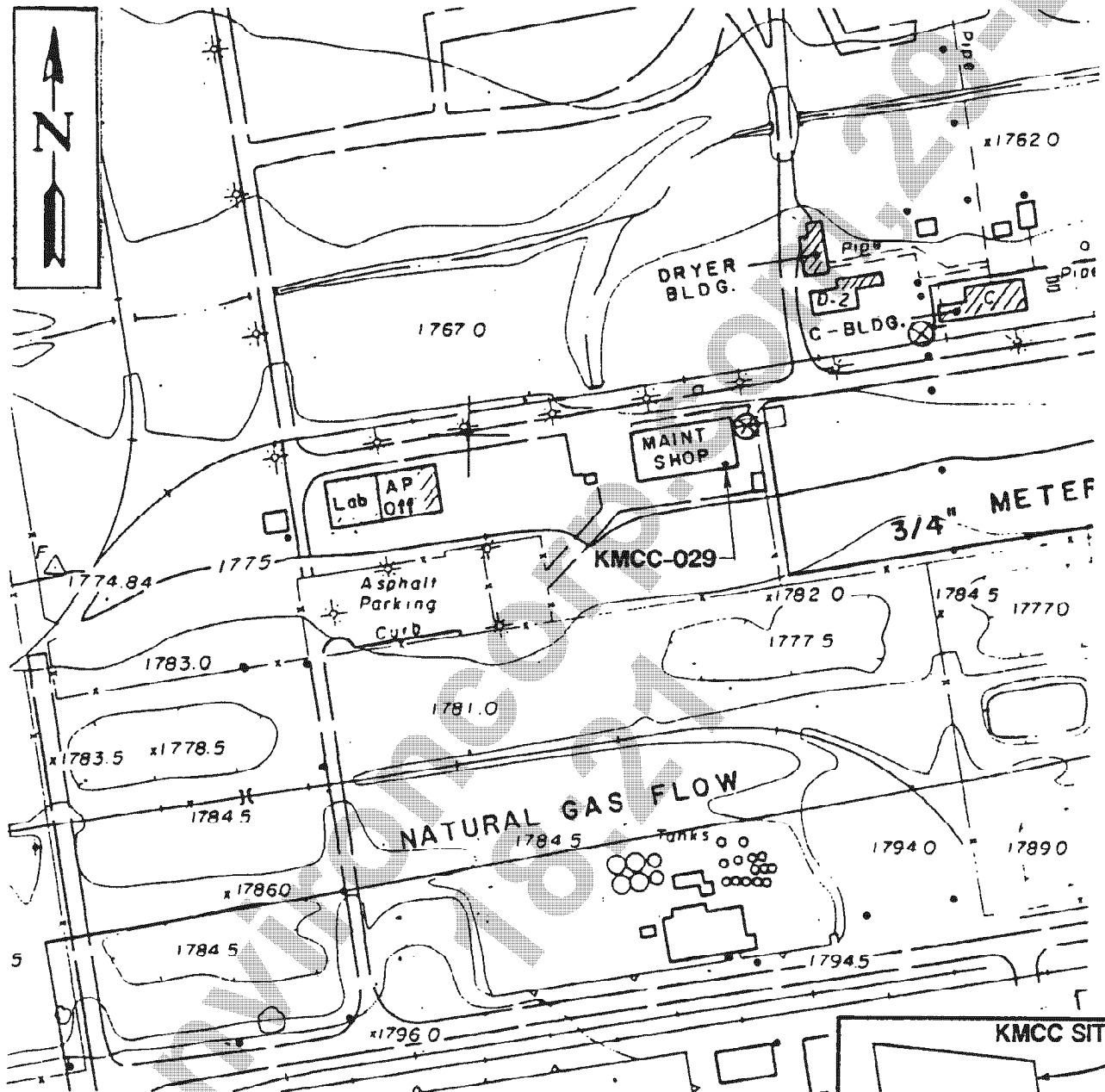

KLEINFELDER

MAP 29: KMCC-029

MAP
29

PR
M-6

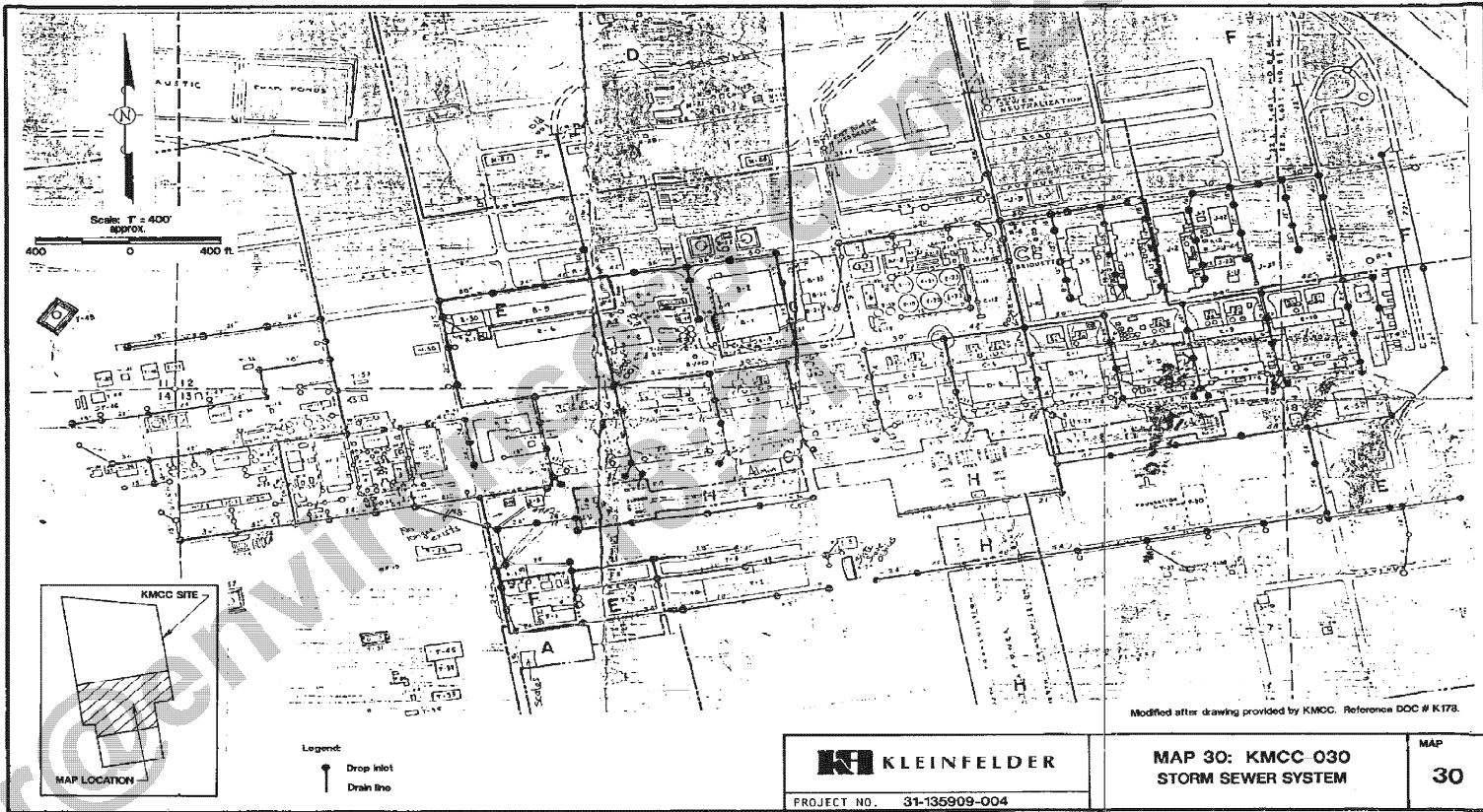

KI KLEINFELDER

PROJECT NO. 31-135909-004

**MAP 30: KMCC O30
STORM SEWER SYSTEM**

MAP
30

KMCC DR
04-000882

L

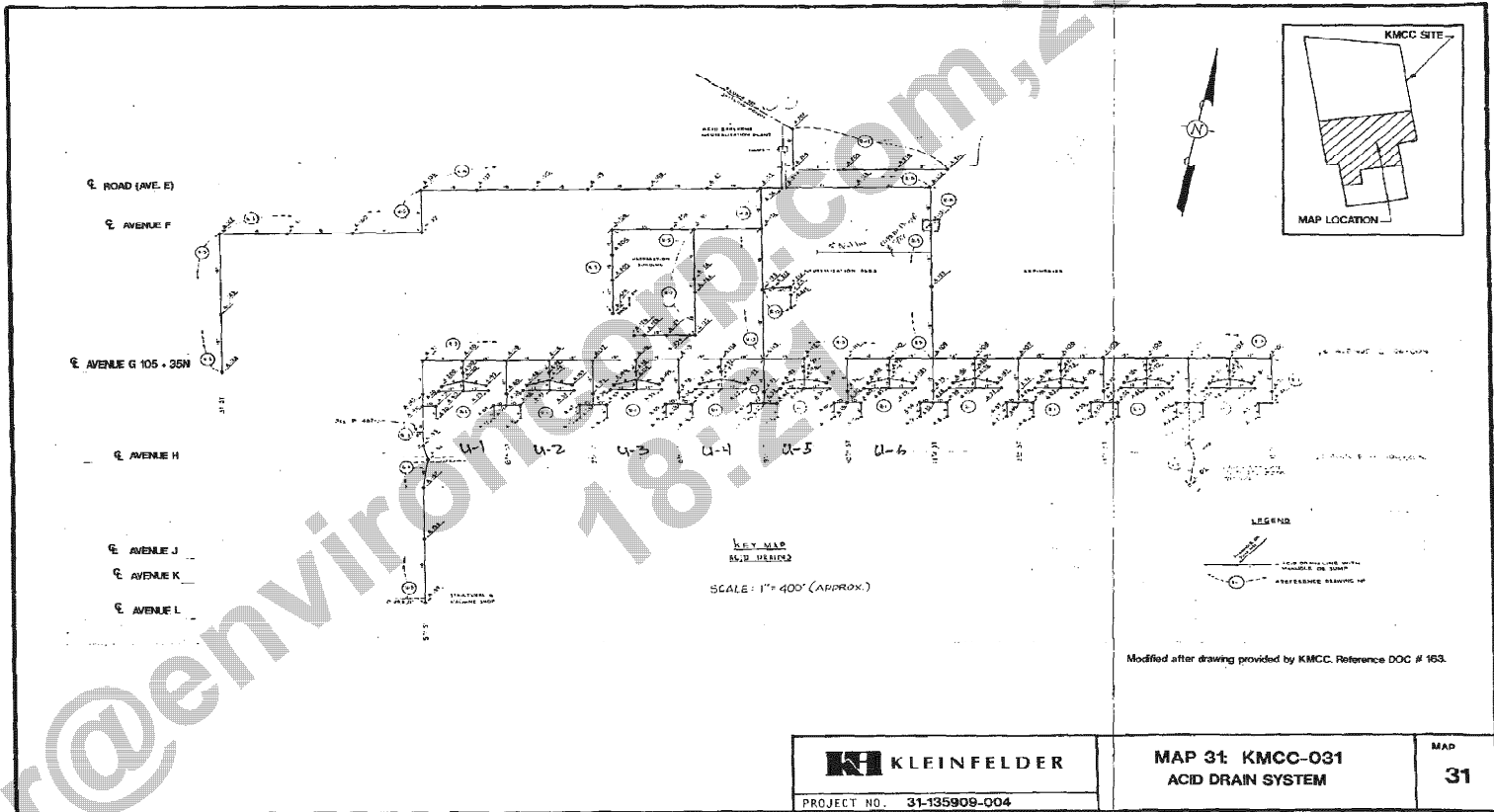

KLEINFELDER

PROJECT NO. 31-135909-004

MAP 31: KMCC-031
ACID DRAIN SYSTEM

MAP
31

KMCC DR
 04/20/18/33

L

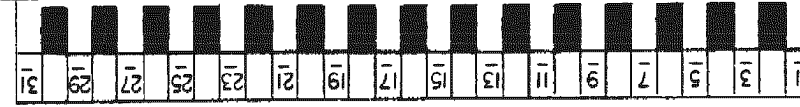
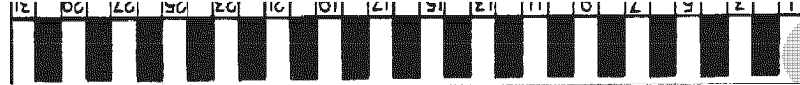
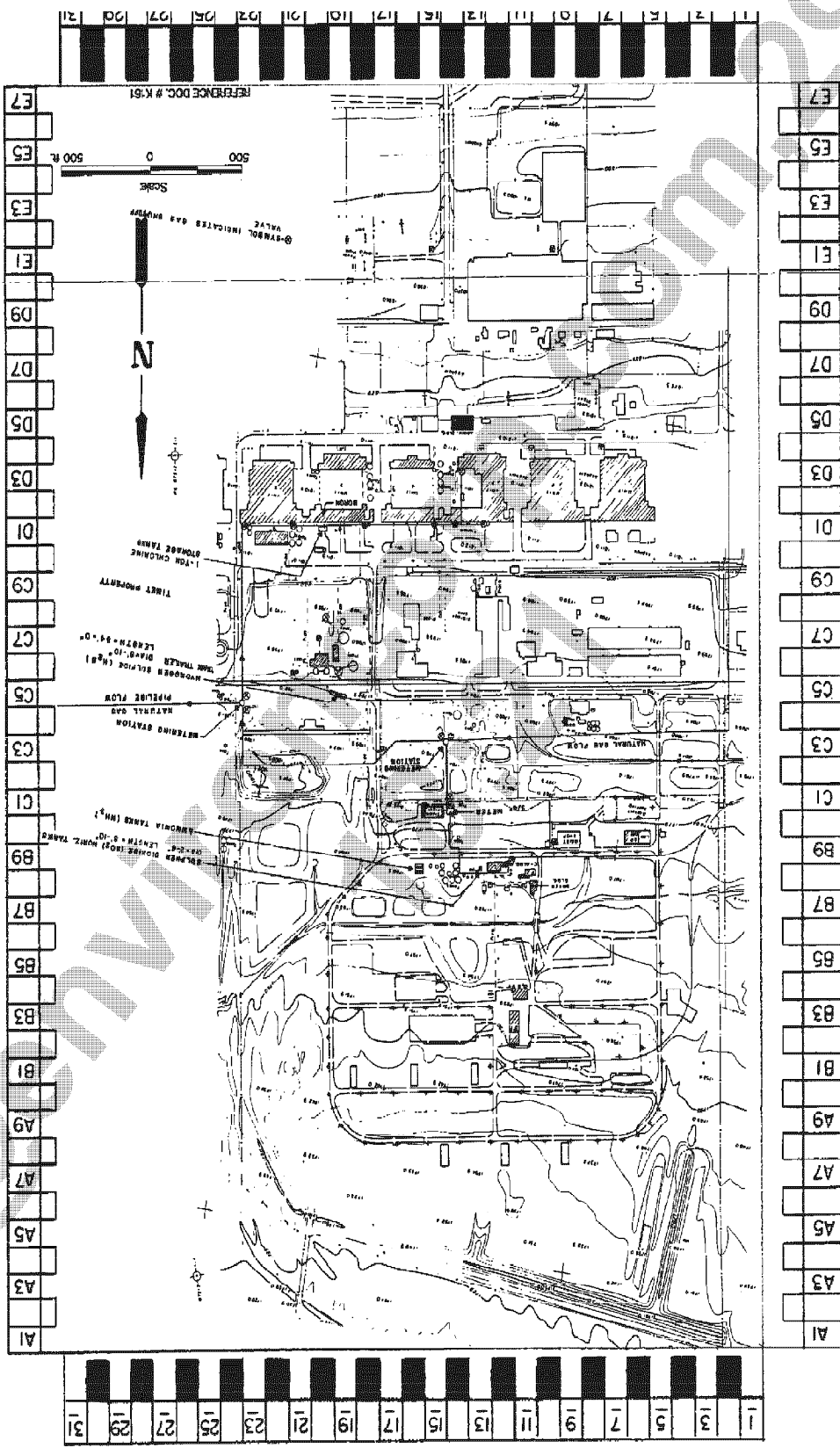

der@environcorp.com, 29-Dec
18:21



*APPENDIX F
PROPERTY*



APPENDIX F

PARCEL DESCRIPTION AND OWNERSHIP INFORMATION

Property descriptions were obtained from the Clark County Assessor's Office. The legal descriptions of the property were obtained by indicating the following information to the Assessor personnel:

- o Property owner and year of transaction; and
- o "Official Book of Records" number and "Instrument Number".

Individuals interested in viewing/obtaining property descriptions can do so at the Clark County Assessor's Office. The Assessor's Office is located at:

309 S. 3rd Street, Fourth Floor
Las Vegas, Nevada 89101

Phone No: (702) 455-3883

The property descriptions for Kerr-McGee Chemical Corporation are contained in Books 57 and/or 68, Instrument No. 389974; Book 349, Instrument No. 282224; and Book 70, Instrument No. 405819 (Reference Doc. K142, K262).

The following sections contain the Historic Summary (F1) and the Current Assessor's Detail (F2).

INDEX

HENDERSON PLANT

RIGHTS OF WAY AND EASEMENTS

EASEMENTS GRANTED BY OR EXISTING ON AMERICAN POTASH & CHEMICAL CORPORATION'S HOLDINGS

<u>FILE NO.</u>	<u>FROM</u>	<u>TO</u>	<u>PURPOSE</u>
ES 1101	Colorado River Commission	Colorado River Commission	To maintain, operate, repair, or replace electrical power transe
ES 1102	Western Electrochemical Company	Arrowhead Line & Chemical Co.	For ingress and egress to Arrowhead property along stream
ES 1103	American Potash & Chemical Corp.	City of Henderson	To construct, maintain, and repair sewage lines.
ES 1104	Western Electro Chemical Co.	Southern Nevada Power Co.	To erect, operate, and maintain electrical transmission line
ES 1105	Western Electro Chemical Co.	Dept. of the Navy	Access to and from USN facilities.
ES 1106	State of Nevada	Southern Nevada Power Co.	To construct, operate, and maintain electric power lines
ES 1107	Reconstruction Finance Corp.	Reconstruction Finance Corp.	To erect, operate, and maintain electrical transmission line
ES 1108	American Potash & Chemical Corp.	Amargosa Valley Cooperative, Inc.	To construct, locate, operate and maintain an electric line together with poles, towers, crossarms, cables, wires, for said electric transmission line for the purpose only of electric power from the Bureau of Reclamation distribution at to Co-op's members in Amargosa Valley, Nevada.

INDEX

HENDERSON PLANT

RIGHTS OF WAY AND EASEMENTS

EASEMENTS GRANTED BY OR EXISTING ON AMERICAN POTASH & CHEMICAL CORPORATION'S HOLDINGS

<u>TO</u>	<u>PURPOSE</u>	<u>DATE</u>	<u>FILE</u>
Colorado River Commission	To maintain, operate, repair, or replace electrical power transmission lines.	Aug. 1, 1952	ED 1101
Company American Lime & Chemical Co.	For ingress and egress to Arrowhead property along Avenue G.	Jan. 21, 1953	ED 1102
City of Henderson	To construct, maintain, and repair sewage lines.	Aug. 23, 1956	ED 1103
Southern Nevada Power Co.	To erect, operate, and maintain electrical transmission lines.	Nov. 21, 1955	ED 1104
Dept. of the Navy	Access to and from USN facilities.	May 19, 1951	ED 1105
Southern Nevada Power Co.	To construct, operate, and maintain electric power lines	Aug. 26, 1950	ED 1106
Reconstruction Finance Corp.	To erect, operate, and maintain electrical transmission lines	June 3, 1949	ED 1107
Amargosa Valley Cooperative, Inc.	To construct, locate, operate and maintain an electric transmission line, together with poles, towers, crossarms, cables, wires, guys and supports for said electric transmission line for the purpose only of transmitting electric power from the Bureau of Reclamation Substation at Henderson, Nevada to Co-op's members in Amargosa Valley, Nevada.	February 14, 1963	ED 1108

KMC DR
04-0008858

NAME OF PROPERTY

HENDERSON PLANT

OWNER AMERICAN POTASH & CHEMICAL CORPORATION

OWNER OF RECORD

STATE	COUNTY	DISTRICT	SECTION NUMBER	TOWNSHIP	RANGE	MERIDIAN	LOCATION	DATE
Nebraska	Clark		Section 12 and 13	T 22 S	R 62 E	R1E		
DATE APPL. SURVEY	SURVEY NO.	U.S. MINERAL SURVEYOR	DATE APPL. SURVEY	SURVEYOR GENERAL	SURVEY NO.	DATE APPL. SURVEY	SURVEYOR GENERAL	SURVEY NO.
PATENTEE	DATE OF ISSUANCE	CLASS.	TYPE OF PROPERTY	MIN. CERT. NO.	PATENT NO.	SERIAL NO.	DATE RECORDED	BOOK
CONVEYANCES								
FROM	TO	DATE OF INSTRUMENT	DATE RECORDED	BOOK	PAGE	TYPE OF INSTRUMENT		
Reconstruction Finance Corporation	Colorado River Commission	June 3, 1949				Quitclaim Deed		
Colorado River Commission	Western Mastic Chemical Company	Aug. 1, 1957	Aug. 1, 1957	21	224	Grant Deed		
Western Electric Chemical Company	American Potash & Chemical Corporation	June 21, 1958				Notice Agreement		

COMMISSIONERS: \$1,963,000 for land, buildings, etc. \$11,000 for 1101-A, B, C, and D.

DESCRIPTION: PARCEL A Beginning at the South quarter corner of Section 12, T 22 S, R 62 E, R1E, thence North by (N) 41° West 1270.81 feet along the south line of Section 12 to the intersection with the center line of Fourth Street; thence North 0° 51' 37" East 327.71 feet along the center line of Fourth Street to a point; thence North 81° 08' 23" East 165.00 feet to a point; thence South 0° 51' 37" East 64.50 feet to a point; thence North 81° 08' 23" East 56.00 feet to a point; thence North 0° 51' 37" West 64.50 feet to a point; thence North 81° 08' 23" East 627.31 feet to a point;

KMC DR
04-0008859

HERBERTSON PLANT
AMERICAN POTASH & CHEMICAL CORPORATION

2-3
Formerly First
Patent 1-
51

REC'D. A
(cont.)
Thence North 8° 51' 37" East 189.00 feet to a point on the center line of Avenue F;
Thence South 81° 08' 23" East 848.00 feet along the center line of Avenue F to its intersection with the center line of Fourth Street;
Thence North 8° 51' 37" East 326.72 feet along the center line of Fourth Street to a point on the northerly fence line of B.H.P.;
Thence South 81° 13' 42" East 1942.78 feet along the northerly fence line of B.H.P. to a point on the north and south center line of Section 12;
Thence South 0° 53' 32" East 2985.70 feet along the north and south center line of Section 12 to a point;
Thence South 81° 08' 23" East 121.41 feet along a line which is 1.50 feet north of the center line of building columns common to buildings B-1 and B-2;
Thence South 8° 51' 37" East 108.50 feet to a point;
Thence North 81° 08' 23" East 0.11 feet to a point;
Thence South 8° 51' 37" East 144.00 feet to a point on the north face of a concrete retaining wall;
Thence North 81° 08' 23" East 77.69 feet to a point on the north and south center line of Section 12;
Thence South 0° 53' 32" East 182.18 feet to the south quarter point of Section 12 (which is the point of beginning), containing 5,358,019 square feet or 123.00 acres, more or less, all of which lies in the west half of said Section 12;
RECITING THEREIN those certain lands already conveyed under deed dated June 28, 1951, from the above named grantor to the above named Grantee, which deed is on file as Instrument No. 374 in Book 65 at Page 353 of deeds in the office of County Recorder of Clark County, Nevada.

REC'D. B
Beginning at the North quarter corner of Section 13, T 22 S, R 62 E, N1M,
Thence South 0° 05' 03" East 528.98 feet to a point;
Thence South 81° 08' 23" East 22.73 feet to a point;
Thence South 8° 51' 37" East 29.00 feet to a point;
Thence South 81° 08' 23" East 341.00 feet to a point;
Thence North 8° 51' 37" East 65.00 feet to a point;
Thence South 81° 08' 23" East 362.00 feet to a point;
Thence South 8° 51' 37" East 234.00 feet to a point;
Thence North 81° 08' 23" East 362.00 feet to a point;
Thence North 8° 51' 37" East 49.00 feet to a point;
Thence North 81° 08' 23" East 310.27 feet to a point;
Thence South 0° 05' 03" East 1905.11 feet to a point on the center line of U.S. Highway;
Thence South 81° 08' 23" East 118.05 feet to a point;
Thence North 8° 51' 37" East 1591.50 feet to a point on the center line of Avenue J;
Thence South 81° 08' 23" East 740.50 feet to a point on the center line of Fourth Street;
Thence North 8° 51' 37" East 508.50 feet along the center line of Fourth Street to a point on the center line of Avenue H;
Thence North 81° 08' 23" East 355.0 feet along the center line of Avenue H to a point on the center line of Fifth Street;
Thence North 8° 51' 37" East 555.0 feet along the center line of Fifth Street to a point on the center line of Avenue O;
Thence South 81° 08' 23" East 355.0 feet along the center line of Avenue O to a point on the center line of Fourth Street;
Thence North 8° 51' 37" East 1172.7 feet along the center line of Fourth Street to a point on the north line of Section 13;
Thence South 81° 08' 23" East 1278.82 feet along the north line of Section 13 to the north quarter point, which is the point of beginning, containing 1,340,046 square feet or 30.76 acres, more or less, all of which lies in the west quarter of said Section 13.

KMC DR
04-0008860

T

HEMERSON PLANT
AMERICAN POTASH & CHEMICAL CORPORATION

Formerly
Pala

PARCEL C Beginning at the North quarter corner of Section 13, T 22 S., R 62 E., N1M,
Thence South 80° 59' 52" East 1456.55 feet along the north line of Section 13 to a point on the center line of Eleventh Street;
Thence South 8° 51' 37" East 637.87 feet along the center line of Eleventh Street;
Thence South 81° 00' 23" East 10.0 feet to a point;
Thence North 8° 51' 37" East 335.75 feet to a point;
Thence South 81° 00' 23" West 240.0 feet to a point;
Thence North 8° 51' 37" East 65.0 feet to a point;
Thence South 81° 00' 23" East 34.0 feet to a point;
Thence North 8° 51' 37" East 6.0 feet to a point;
Thence South 81° 00' 23" East 12.0 feet to a point;
Thence South 8° 51' 37" East 6.0 feet to a point;
Thence South 81° 00' 23" East 64.0 feet to a point;
Thence South 8° 51' 37" East 1.5 feet to a point;
Thence South 81° 00' 23" East 212.0 feet to a point;
Thence South 8° 51' 37" East 61.5 feet to a point;
Thence South 81° 00' 23" East 903.0 feet to a point;
Thence North 8° 51' 37" East 29.0 feet to a point;
Thence South 81° 00' 23" East 12.27 feet to a point on the north and south center line of Section 13;
Thence North 0° 05' 03" East 578.98 feet along the north and south center line of Section 13 to the point of beginning, containing 622.187 square feet or 14.28 acres, more or less, all of which lies in the Northwest quarter of Section 13,
AND, beginning at the Northeast corner of Section 13, T 22 S., R 62 E., N1M, thence South 76° 31' 05" East 2727.32 feet to a point on the north and south center line of Section 13, which point is the true point of beginning;
Thence North 81° 08' 23" East 350.73 feet to a point on the west boundary of 24th Street;
Thence North 8° 51' 37" East 120.0 feet to a point;
Thence North 81° 08' 23" East 10.0 feet to a point on the east boundary of Eighth Street;
Thence South 8° 51' 37" East 120.0 feet to a point;
Thence North 81° 08' 23" East 350.0 feet to a point;
Thence South 8° 51' 37" East 215.75 feet to a point;
Thence North 81° 08' 23" East 637.0 feet to a point;
Thence South 8° 51' 37" East 126.25 feet to a point;
Thence South 81° 00' 23" East 154.0 feet to a point;
Thence South 8° 51' 37" East 232.5 feet to a point on the north boundary of Avenue 1;
Thence North 81° 08' 23" East 454.0 feet to a point;
Thence South 8° 51' 37" East 40.0 feet to a point on the south boundary of Avenue 1;
Thence South 81° 00' 23" East 154.0 feet to a point;
Thence South 8° 51' 37" East 1167.5 feet to a point on the north boundary of B N P Highway;
Thence North 81° 00' 23" East 154.0 feet to a point;
Thence South 8° 51' 37" East 200.0 feet to a point on the south boundary of B N P Highway;
Thence South 81° 08' 23" West 554.0 feet to a point;
Thence North 8° 51' 37" West 100.0 feet to a point;

KMC DR
04-0008861

1

HEMIGON PLANT
AMERICAN POTASH & CHEMICAL CORPORATION

FOIA

PARCEL G Thence South 81° 08' 23" East 1119.94 feet along the center line of B H P Highway to a point;
(Cont.) Thence North 0° 05' 03" East 1905.17 feet along the north and south center line of Section 13 to the true point of beginning, containing 560,944 square feet or 12.88 acres (49.56 acres land office calculation), more or less, all of which lies in the Northeast quarter of said Section 13.

This parcel is subject to the following easements:

- (a) Easements granted to United States Bureau of Reclamation by Colorado River Commission in 1949, for transmission lines.
- (b) An easement area 17.0 feet wide, being all of that area lying within eight and one-half feet of the center line of railroad tracks #12 and #13.
- (c) That portion lying within the boundaries of B H P Highway is reserved as a highway for access to the public to Basic Magnesium Project.

PARCEL D Beginning at the South quarter corner of Section 12, T 22 S, R 62 W, N1/4, thence North 0° 53' 32" East along the north and south center line of Section 12 a distance of 189.18 feet to a point;

Thence North 81° 08' 23" East 597.98 feet to a point;
Thence North 8° 51' 37" East 490.50 feet to a point;
Thence South 81° 08' 23" West 304.00 feet to a point;
Thence South 8° 51' 37" East 238.00 feet to a point; S. E.
Thence South 81° 08' 23" East 254.59 feet to a point on the north and south center line of Section 12 (said course being along a line which is 1.50 feet northerly from the center line of columns common to buildings B-1 and B-2);
Thence North 0° 53' 32" East along the north and south center line of Section 12 a distance of 2985.2 feet to a point on the northerly fence line of B H P;
Thence South 81° 13' 42" East 536.47 feet along the northerly fence line of B H P;
Thence South 61° 16' 20" East 111.74 feet along the northerly fence line of B H P;
Thence South 8° 51' 37" East 3255.31 feet along the center line of Eleventh Street to its intersection with the south line of Section 12;
Thence North 88° 59' 59" East along the south line of Section 12 a distance of 1456.55 feet to the point of beginning, containing 3,110,838 square feet or 85.19 acres, more or less, all of which lies in the East half of said Section 12.
Excepting therefrom those certain lands already conveyed under deed dated June 28, 1951, from the above named grantor to the above named grantees, which deed is on file as Instrument # _____ at Page 353 of deeds in the office of County Recorder of Clark County, Nevada.

SUBJECT TO: There is expressly reserved unto RECONSTRUCTION FINANCE CORPORATION, its successors and assigns, all minerals and all mineral rights which may be located upon or under the real property described, together with the right to enter upon, prospect from, mine and remove such minerals; provided, however, that any development of the property for mineral purposes shall be in a manner as to not unreasonably interfere with the use of this property.

Furthermore, the grantor does hereby reserve unto himself, his successors and assigns, an easement over the following areas for the purpose of allowing the grantor, his successors and to maintain in place and to operate, repair and/or replace the existing electrical power transmission lines, electric circuits, pipe lines, conduits, tunnels, railroads, stone lines & lines. This easement reserved is for the stated limited purposes only and shall not be extended to the general public, nor shall the grantees, its successors or assigns, be prohibited any fence or other structure upon the easement areas as long as said areas remain accessible to the grantor, its successors and assigns, for the limited purposes above stated. Said easement areas shall be as shown by the map attached hereto and by this reference made a part hereof, which easements are more particularly described as follows:

KMC DR
04-0008862

Twenty foot wide easements:

1. East half of Fourth Street.
2. East half of Fifth Street between center lines of Avenue D and Avenue H.
3. West half of Eleventh Street for a distance of 1675 feet northerly from its intersection with the center line of Avenue H.
4. West half of Eleventh Street for a distance of 433.75 feet southerly from its intersection with the center line of Avenue H.
5. North half of Avenue F.
6. South half of Avenue F from the center line of Eleventh Street to a point 187 feet westerly therefrom.
7. North half of Avenue G from center line of Fourth Street to the center line of Ninth Street. (Compare grant of easement J-E-51, between U. S. Lime Corp. and State of Nevada).

Twenty-five foot wide easements:

That area lying westerly from and adjacent to the center line of Ninth Street between the center line of Avenue F and the center line of Avenue G. (See grant of easement of J-E-51 by State of Nevada to U. S. Lime Corp.).

Sixty foot wide easement:

That area lying northerly from and adjacent to the north boundary of Avenue G between points lying 224 feet and 697 feet westerly from the center line of Ninth Street.

One hundred foot wide easement:

The north half of B N P entrance highway for distances 553 feet easterly and 785 feet westerly from the center line of Eighth Street.

Fifteen foot wide easements:

This is the area lying five feet northerly and ten feet southerly from a line parallel to and twenty-one feet southerly from the center line of Avenue H between the center line of Fourth Street and a point 2381 feet easterly therefrom.

Seventeen foot wide easement:

This is the area lying five feet northerly and twelve feet southerly from a line parallel to and twenty-one feet southerly from the center line of Avenue H, from the center line of Eleventh Street to a point 314 feet westerly therefrom.

Seventeen foot wide easements:

Those areas are those lying within eight feet six inches from the center lines of the following railroad tracks:

- 15, 5A, 6, 8A, 10, 11, 12, and 13.

KMC DR
04-0008863

HENDERSON PLANT
AMERICAN POTASH & CHEMICAL CORPORATION

on the West boundary of Eleventh Street projected; thence South $8^{\circ} 51' 37''$ East 767.34 feet along said West boundary to a point on the North fence line of B.M.P; thence leaving said West 387.59 feet along said North fence line to an angle point thereon; thence continuing along said fence line North $86^{\circ} 13' 42.5''$ West 3118.39 feet to the West line of Section 12; thence N along said West line to the point of beginning, containing 151,3689 acres, more or less.

PARCEL NO. 2
Beginning at the Southwest corner of Section 12, Township 22 South, Range 62 East Mt. Diablo Base and meridian; thence North $51^{\circ} 52' 46.5''$ East 1571.58 feet to the true point of beginning; thence North $8^{\circ} 51' 37''$ West 2635.00 feet to a point on the North fence line of Basic Magnesium Plant; thence South $86^{\circ} 13' 42.5''$ East 2418.12 feet along said fence line to an angle point; thence South $63^{\circ} 17' 49''$ East 387.59 feet to a point on the West line of Eleventh Street projected; thence South $8^{\circ} 51' 37''$ East 1798.74 feet along said West line to a point in Section 12 bears South $44^{\circ} 25' 17''$ East 2059.78 feet; thence South $81^{\circ} 00' 23''$ West 2654.99 feet to the true point of beginning, containing 138,9621 acres more or less.

TOGETHER WITH all of the Government's rights, title and interest in and to that certain easement granted by Stanfrod Chemical Company of Nevada, a Nevada Corporation, to the United States dated December 10, 1952, recorded May 27, 1953, as document No. 409819, in Book 70 of Deeds, at page 386, Official Records of Clark County, Nevada.

SUBJECT TO rights of way, restrictions, reservations and easements existing or of record.

SUBJECT TO covenants, restrictions, conditions and reservations of a NATIONAL SECURITY CLAUSE.

EXCEPTIONS:

UNITED STATES OF AMERICA:	Reservations in patent from the United States of America, recorded October 24, 1941 in Book 29 of Deeds, page 129, Clark County, Nevada records, as follows: "reserving, however, to the United States all oil, coal, or other mineral any time found in said lands, together with the right to prospect for, mine and run conditions and under such rules and regulations as the Secretary of the Interior may prescribe."
STATE OF NEVADA:	Reservations in patents from the State of Nevada, as follows: "Provided that all mines of gold, silver, copper, lead, zinc, uranium and other valuable minerals which may exist in the said tract, except gas, coal, oil and oil
SOUTHERN NEVADA POWER COMPANY:	An easement over a portion of Section 12, Township 22 South, Range 62 East, (as indicated on the map of easement areas for Electrical lines of Southern Nevada being Issue No. 2 of map U-135), for pole lines and incidental purposes, as granted to Southern Nevada Power Co., by instrument recorded October 10, 1950 as Nevada records.

KMC DR
04-0003864

NAME OF PROPERTY

DEFENSE PLANT

OWNER AMERICAN POTASH & CHEMICAL CORPORATION

OWNER OF RECORD

STATE	COUNTY	DISTRICT	SECTION NUMBER	TOWNSHIP	RANGE	MERIDIAN	LOCATOR	DATE		
Nevada	Clark		Sections 1 and 12	T 22 S	R 62 E	H1M				
DATE APPL. SURVEY	SURVEY NO.	U. S. MINERAL SURVEYOR	DATE APPL. SURVEY	SURVEYOR GENERAL	SURVEY NO.	DATE APPL. MIN. MON.	SURVEYOR GENERAL	SURVEY NO.	MIN. MON. DE. IN.	
PATENTEE	DATE OF ISSUANCE	ACREAGE	TYPE OF PROPERTY	MIN. CERT. No.	PATENT No.	SERIAL No.	DEPT. LAND OFF. No.	DATE RECORDED	BOOK	PAGE
		290.331 A.								
CONVEYANCES										
FROM	TO	DATE OF INSTRUMENT	DATE RECORDED	BOOK	PAGE	TYPE OF INSTRUMENT				
United States of America	American Potash & Chemical Corporation	March 15, 1962	March 23, 1962	Book 309	Page 28224	Quitclaim Deed				
NOTES										
<p>DESCRIPTION: Parcel that certain property being a portion of what is commonly known as the Nasc Magnesium Project in the County of Clark, State of Nevada, and more particularly described as follows:</p> <p>PARCEL NO. 1</p> <p>Beginning at the Section corner common to Sections 1, 2, 11 and 12, Township 22 South, Range 62 East, N.D.R. 6M.; thence North 1° 16' 15" West 1314.14 feet along the West line of Section 1; thence leaving said West line South 89° 36' 55" East 1252.59 feet more or less to the Southwesterly line of Athol Atomic as shown on the Plat of Sierra Vista City, recorded in Book 2 of Plats, page 5, Clark County, Nevada records; thence South 42° 21' 00" East 41.39 feet along said Southwesterly line; thence leaving said Southwesterly line South 03° 47' 53" East 1205.42 feet to a point on the South line of said Section 1; thence South 89° 31' 45" East 1269.30 feet along said South line to the Quarter corner common to said Sections 1 and 12; thence leaving said South line South 0° 51' 32.5" West 1317.21 feet; thence South 89° 33' 08" East 753.00 feet to a point</p>										

KMC DR
04-0008865

1

HEMLOCK PLANT
AMERICAN POTASH & CHEMICAL CORPORATION

CELL NO. 5 (Unit 4 in Section 13)

Beginning at the Northeast Corner of Section 13, T 22 S and R 62 E of N10W; thence North 88° 59' 59.5" West along the North line of said Section 13 a distance of 2007.56 feet to a point, said point being the true point of beginning; thence North 88° 59' 59.5" West along the North line of said Section 13 a distance of 355.25 feet to a point; thence South 8° 51' 37" East a distance of 170.00 feet to a point; thence North 81° 08' 23" East a distance of 350.00 feet to a point; thence North 8° 51' 37" East a distance of 298.18 feet to the true point of beginning, containing 148.25 square feet or 2.660 acres more or less, all of which lies in the Northeast one quarter of Section 13, T 22 S and R 62 E of N10W.

CELL NO. 6 (Office Bldg. X-36 Area)

Beginning at the Northeast Corner of Section 13, T 22 S, R 62 E, N10W, thence South 63° 53' 12" West 992.50 feet to a point said point being the true point of beginning; thence South 8° 51' 37" East 170.00 feet to a point; thence South 81° 08' 23" West 210.00 feet to a point; thence North 8° 51' 37" West 160.00 feet to a point; thence North 81° 08' 23" East 210.00 feet to the point of true beginning, containing 33,600.0 square feet or 0.771 acres more or less, all of which lie in the Northeast 1/4 of said Section 13.

CELL NO. 7 (Change House S 2, South 1/2)

Beginning at the Northeast Corner of Section 13, T22S, R62E, N10W, thence South 79° 31' 01" West, 2202.41 feet to a point, said point being the true point of beginning; thence South 8° 51' 37" East 170.00 feet to a point; thence South 81° 08' 23" West 126.33 feet to a point; thence North 8° 51' 37" East 36.00 feet to a point; thence North 81° 08' 23" East 126.33 feet to the point of true beginning, containing 1547.88 square feet or 0.101 acres more or less, all of which lie in the Northeast 1/4 of said Section 13.

CELL NO. 8 (Storage Yard Between Tr. 11 & 12 and 8th & 9th St.)

Beginning at the Northeast Corner of Section 13, T 22 S, R 62 E, N10W thence South 77° 42' 52" West 1981.45 feet to a point said point being the true point of beginning; thence South 8° 51' 37" East 170.00 feet to a point; thence South 81° 08' 23" West 350.00 feet to a point; thence North 8° 51' 37" East 391.00 feet to a point; thence North 81° 08' 23" East 350.00 feet to the point of true beginning, containing 136,850.00 square feet or 3.112 Acres more or less, all of which lies in the Northeast 1/4 of said Section 13; except easement for ingress and egress for maintenance of utilities, overhead power lines and supporting towers, electric control tunnel, electric ducts, grounding cables, storm line trench, water lines and manholes for access to underground structures, as now existing on tract as shown but not necessarily limited to only those shown on Drawing R-518.

KMC DR
04-0008866

MINNESOTA PLANT
AMERICAN POTASH & CHEMICAL CORPORATION

A portion of the lands herein conveyed are subject to that certain war reservation clause, known as paragraph Eight, beginning Page 9, of that certain lease dated February 1, 1916, by and between RECONSTRUCTION FINANCE CORPORATION and WESTERN ELECTROCHEMICAL COMPANY, said lease being on file in the office of the County Recorder of Clark County, Nevada, as Instrument No. 781366.

Together with the appurtenances thereunto belonging, and all buildings, improvements, equipment, fixtures, and personal property thereon situated or belonging thereto.

The above mentioned portions subject to the war reservation clause are more particularly described as follows:

PARCEL NO. 1 (Salt Storage Building)

Beginning at the Southeast Corner of Section 12, T 22 S, and R 62 E of Mount Diablo Base and Meridian, thence North $70^{\circ} 07' 26''$ West a distance of 2932.90 feet to a point, said point being the true point of beginning; thence South $81^{\circ} 08' 23''$ West a distance of 257.00 feet to a point; thence North $8^{\circ} 51' 37''$ West a distance of 95.17 feet to a point; thence North $81^{\circ} 08' 23''$ East a distance of 257.00 feet to a point; thence South $8^{\circ} 51' 37''$ East a distance of 95.17 feet to the true point of beginning, containing 24458.69 square feet or 0.561 acres more or less all of which lies in the Southwest one quarter of Section 12 T 22 S and R 62 E of MIM.

PARCEL NO. 2 (Acid Tank Heat. Area)

Beginning at the Southeast Corner of Section 12, T 22 S and R 62 E of MIM; thence North $75^{\circ} 16' 31''$ West a distance of 1997.26 feet to a point, said point being the true point of beginning; thence South $81^{\circ} 08' 23''$ West a distance of 58.41 feet to a point; thence North $8^{\circ} 51' 37''$ West a distance of 21.00 feet to a point; thence North $81^{\circ} 08' 23''$ East a distance of 58.41 feet to a point; thence South $8^{\circ} 51' 37''$ East a distance of 21.00 feet to the true point of beginning, containing 1101.84 square feet or 0.025 Acres more or less, all of which lies in the Southeast one quarter of Section 12, T 22 S and R 62 E of MIM.

PARCEL NO. 3 (R.R. Unloading Platform)

Beginning at the Southeast Corner of Section 12 T 22 S and R 62 E of MIM; thence North $81^{\circ} 49' 17''$ West a distance of 2058.62 feet to a point, said point being the true point of beginning; thence South $81^{\circ} 08' 23''$ West a distance of 260.00 feet to a point; thence North $8^{\circ} 51' 37''$ West a distance of 11.00 feet to a point; thence North $81^{\circ} 08' 23''$ East a distance of 260.00 feet to a point; thence South $8^{\circ} 51' 37''$ East a distance of 11.00 feet to the true point of beginning, containing 3380.00 square feet or 0.078 Acres more or less, all of which lies in the Southeast one quarter of Section 12, T 22 S and R 62 E of MIM.

PARCEL NO. 4 (Unit 4 in Section 12)

Beginning at the Southeast Corner of Section 12, T 22 S and R 62 E of MIM; thence North $88^{\circ} 59' 59.5''$ West along the South line of said Section 12 a distance of 2007.56 feet to a point, said point being the true point of beginning; thence North $88^{\circ} 59' 59.5''$ West along the South line of said Section 12 a distance of 355.25 feet to a point; thence North $8^{\circ} 51' 37''$ West a distance of 130.99 feet to a point; thence North $81^{\circ} 08' 23''$ East a distance of 350.00 feet to a point; thence South $8^{\circ} 51' 37''$ East a distance of 191.82 feet to the true point of beginning containing 54491.75 square feet or 1.247 Acres more or less, all of which lies in the Southeast one quarter of Section 12, T 22 S and R 62 E of MIM.

KMC DR
04-0003867

der@environcorp.com, 29-Dec
18:22

This record is for assessment use only.
No liability is assumed to the accuracy.

PCL 210-090-001 TAX DISTRICT - 526
AMERICAN POLYSH & CHEMICAL CORP PL N2
----- ASSESSOR DESCRIPTION -----
DOCUMENT - 0349:02P224 03/23/62 1 NS
ACRES - 9.25
GEOD - PT S14 NE4 SEC 12 22 62
UPDATE - S-999-999-72 12/03/71 LAST - 10/16/92
COMMENT - INITIAL

T

PCL 210-090-003 TAX DISTRICT-- 525 ----- ASSESSOR DESCRIPTION -----
AMERICAN POTASH & CHEMICAL CORP PT S2 NE4 SEC 12 22 62

DOCUMENT-- 0349:0202224 03/23/62 1 NS
ACRES-- 10.70
GEOID-- PT S04 NE4 SEC 12 22 62
UPDATE-- S-999-999-72 12/03/71 LAST-- 10/16/92
COMMENT-- INITIAL

This record is for assessment use only.

No liability is assumed for this copy.

KMC DR
04-0008869

T

der@environcorp.com, 29-Dec
18:22

This record is for assessment use only.
No liability is assumed to its contents.

AMERICAN POLISH & CHEMICAL CORP
INSTRUMENT - 929
ASSESSOR DESCRIPTION
PL 52 HQ4 SITE 17 22 62
DOCUMENT - 039910202224 03/23/62 1 HS
ACRES - 36.23
GEOTID - PL 52 HQ4 SEC 12 22 62
UPDATE - 8-999-999-77 12/03/71 LAST - 10/16/92
COMMENT - INITIAL

T

der@environcorp.com, 29-Dec
18:22

F2-4

KMC DR
04-0008871

This records for assessment of the site.
No liability is assumed for its accuracy.

AMERICAN POLISH & CHEMICAL CORP
P1 H2
DOCUMENT - 0349:020224 03/23/62 1 HS
ACRES - 26.90
GEOID - P1 S2 N14 SEC 12 22 62
UPDATE - S-999-999-72 12/03/71 LAST - 10/16/92
COMMENT - INITIAL

SECTION
SEC 12 22 62

T

der@environcorp.com, 29-Dec
18:22

F2-5

KMC DR
04-0008872

This record is for assessment use only.
No liability is assumed to its accuracy.

PCL 210-000-001 TAX DISTRICT - 025
AMERICAN POLISH & CHEMICAL CORP
PL N2
----- ASSESSOR DESCRIPTION -----
DOCUMENT - 0349:0202224 03/23/62 1 MS
ACRES - 77.50
GEOID - A11 N2 N14 SEC 12 22 62
UPDATE - 8-999-999-72 12/03/71 LAST - 07/11/92
COMMENT - INITIAL

T

PCL 210-070-001 TAX DISTRICT- 525 ----- ASSESSOR DESCRIPTION -----
AMERICAN POTASH & CHEMICAL CORP SW4 SW4 SEC 01 22 62

DOCUMENT- 0349:0202224 03/23/62 1 HS
ACRES- 30.71
GE01D- ALL SW4 SW4 SEC 01 22 62
UPDATE- S-999-999-72 12/03/71 LAST- 10/29/92
COMMENT- INITIAL

This record is for assessment use only.
No liability is assumed to its accuracy.

der@environcorp.com, 29-Dec
18:22

PCL 210-100-001 TAX DISTRICT- 525 ----- ASSESSOR DESCRIPTION -----
AMERICAN POTASH & CHEMICAL CORP PT N2 SE4 SEC 12 22 62
DOCUMENT- 0349:0202224 03/23/62 1 NS
ACRES- 32.00
GEOID- PT NW4 SE4 SEC 12 22 62
UPDATE- S-999-999-72 12/03/71 LAST- 11/06/92
COMMENT- INITIAL

This record is for assessment use only

No liability is assumed for its use.

der@environcorp.com 29-Dec
18:22

KMC DR
04-0008874

T

der@environcorp.com, 29-Dec
18:22

F2-8

KMC DR
04-0008875

PCL 210-130-002 TAX DISTRICT- 625
AMERICAN POLISH & CHEMICAL CORP
PI N2 ----- ASSESSOR DESCRIPTION -----
PI N2 SEC 12 22 62
DOCUMENT- 0349:0202224 03/23/62 1 NS
ACRES- 48.62
GEOID- PI N2 SEC 12 22 62
UPDATE- S-999-999-72 12/03/71 LAST- 10/16/92
COMMENT- INITIAL
THE GOVT HAS REVIEWED AND APPROVED
THE PROPOSED MAPS AND RECORDS

T

der@environcorp.com,29-Dec
18:22

F2-9

KMC DR
04-0008876

This records for assessment use only.
No liability is assumed to its accuracy.

PCL 210-120-004 FAX DISTRICT-- 575
AMERICAN POLISH & CHEMICAL CORP
P1 S2 S04
ASSESSOR DESCRIPTION
DOCUMENT-- 0348:0202224 03/23/62 1 HS
AGRES-- 11.46
GEOD- P1 S2 S04 SEC 12 22 62
UPDATE- S-999-999-72 12/03/71 LAST- 10/16/92
COMMENT-- INITIAL

T

PCL 210-120-005 TAX DISTRICT- 525 ----- ASSESSOR DESCRIPTION-----
KERR MCGEE CHEMICAL CORP PT S2 SW4 SEC 12 22 62

DOCUMENT- 9999:9999999 02/02/68 1 NS
ACRES- 13.97
GE010- PT S2 SW4 SEC 12 22 62
UPDATE- A-171-249-77 07/20/76 LAST- 10/16/92
COMMENT- 066:305431

PARCEL- 210-120-005 INACTIVE- 013 DOCUMENT- 9999:9999999 02/02/68
KERR MCGEE CHEMICAL CORP TAX DIST- 520 ACRES- 13.97
GE010-

COMM- .19AC TO 210-110-007 UPD- S-021-022-73 01/27/72
----- LAST UPDI 06/20/74

PARCEL- 210-120-005 INACTIVE- 006 DOCUMENT- 0000:0000000
AMERICAN POTASH & CHEMICAL CORP TAX DIST- 520 ACRES- 14.16
GE010-

COMM- INITIAL UPD- S-999-999-72 12/03/71
----- LAST UPDI- 12/03/71

This record is for informational purposes only.
No liability is assumed for its accuracy.

KMC DR
04-0008877

1PT10H -----
12 22 62

ACRES- 2.03
GEOTD- PT SE4 SW4 SEC 12 22 62
UPDATE- S-999-999-72 12/03/71 LAST- 10/16/92
COMMENT- INITIAL

This record is for assessment use only.

No liability is assumed to its accuracy.

der@environcorp.com, 29-Dec
18:22

der@environcorp.com, 29-Dec
18:22

F2-12

KMC DR
04-0008879

Liability is assumed to its owner.

DOCUMENT - 9999:9999999 99/99/99 1 HS
ACRES - 1.46
GEOM - PT S2 SEC 12 22 62
UPDATE - S-999-999-72 12/03/71 LAST - 10/16/92
COMMENT - INITIAL

10N -----
22 02

T

This record is for assessment use only.
No liability is assumed to its accuracy.

PCL 210-120-010 TAX DISTRICT-- 525
 KERR MCGEE CHEMICAL CORP
 ----- ASSESSOR DESCRIPTION -----
 PT S2 S44 SEC 12 22 62
 DOCUMENT-- 9999:999999 02/02/60 1 NS
 ACRES-- 9.02
 GEOTD- PT S2 S44 SEC 12 22 62
 UPDATE- A-171-249-77 07/20/76 LAST-- 10/16/92
 COMMENT-- 066:385431
 PARCEL-- 210-120-010 INACTIVE-- 013 DOCUMENT-- 9999:999999 02/02/60
 KERR MCGEE CHEMICAL CORP
 TAX DIST-- 520 ACRES-- 9.02
 GEOTD--
 COMM-- .20AC TO 210-110-007
 UPD-- S-021-022-73 01/27/72
 ----- LAST UPD-- 06/20/74
 PARCEL-- 210-120-010 INACTIVE-- 005 DOCUMENT-- 0000:0000000
 AMERICAN POTASH & CHEMICAL CORP
 TAX DIST-- 520 ACRES-- 10.02
 GEOTD--
 COMM-- INITIAL
 UPD-- S-999-999-72 12/03/71
 ----- LAST UPD-- 12/03/71

T

der@environmentalcorp.com, 29-Dec-18:22

This is only for assessment use only.
No liability is assumed to its accuracy.

PCL 210-120-012 TAX DISTRICT- 525 ----- ASSESSOR DESCRIPTION -----
 KERR MCGEE CHEMICAL CORP
 DOCUMENT- 9999:999999 02/02/00 1 NS
 ACRES- 1.61
 GEOD- PT SEA S04 SEC 12 22 62
 UPDATE- S-072-421-90 11/23/00 LAST- 10/16/92
 COMM-1-
 PARCEL- 210-120-008 INACTIVE- 037 DOCUMENT- 9999:999999 02/02/00 1 NS
 KERR MCGEE CHEMICAL CORP
 TAX DIST- 526 ACRES- 1.70
 GEOD- PT SEA S04 SEC 12 22 62
 COMM- 066:305431
 UPD- S-130-133-76 00/24/00
 PARCEL- 210-120-008 INACTIVE- 029 DOCUMENT- 9999:999999 02/02/00
 KERR MCGEE CHEMICAL CORP
 TAX DIST- 520 ACRES- 1.70
 GEOD-
 COMM- 310 AC TO 21-11-07
 PARCEL- 210-120-008 INACTIVE- 021 DOCUMENT- 9999:999999 02/02/00
 AMERICAN POTASH & CHEMICAL CORP
 TAX DIST- 520 ACRES- 1.70
 GEOD-
 COMM- 310 AC TO 21-11-07
 UPD- S-152-172-74 10/19/73
 LAST UPD- 07/30/73

T

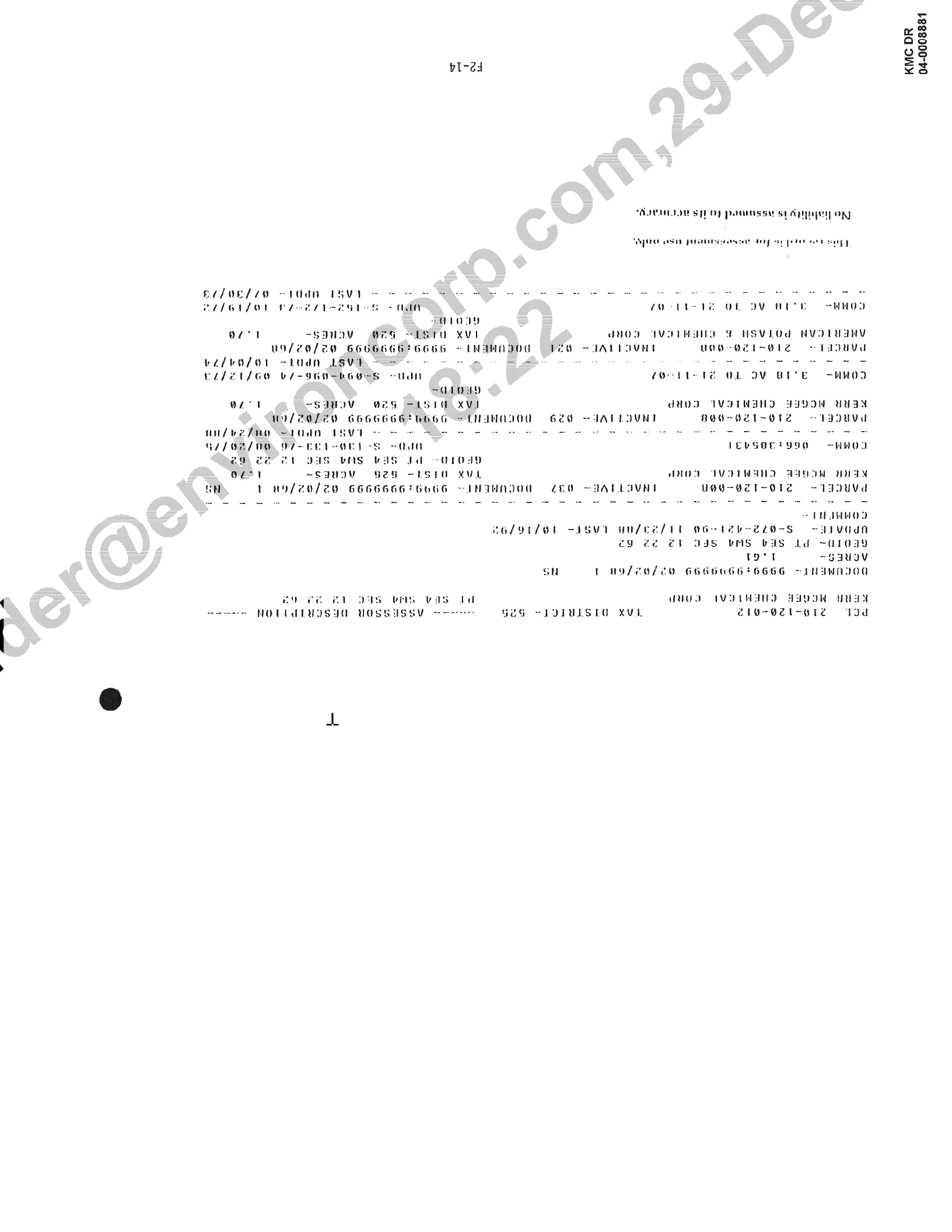

PARCEL- 210-120-000 INACTIVE- 013 DOCUMENT- 9999:9999999 02/02/60
 KERR MCGEE CHEMICAL CORP TAX DIST- 520 ACRES- 1.70
 GE010-
 COMM- 3.18 AC TO 21-11-07 UPD- S-021-022-73 01/27/72
 ----- LAST UPD1- 01/27/72
 PARCEL- 210-120-000 INACTIVE- 005 DOCUMENT- 0000:0000000
 AMERICAN POTASH & CHEMICAL CORP TAX DIST- 520 ACRES- 4.00
 GE010-
 COMM- INITIAL UPD- S-999-999-72 12/03/71
 ----- LAST UPD1- 12/03/71
 PCL 210-120-013 TAX DISTRICT- 525 ASSESSOR DESCRIPTION
 CHEMSTAR INC PT SE4 SW4 SEC 12 22 62

 DOCUMENT- 001010:00062 10/10/00 1 HS
 ACRES- .09
 GE010- PT SE4 SW4 SEC 12 22 62
 UPDATE- S-072-421-90 11/23/00 LAST- 01/12/93
 COMMENT-

 PARCEL- 210-120-000 INACTIVE- 037 DOCUMENT- 9999:9999999 02/02/60 1 HS
 KERR MCGEE CHEMICAL CORP TAX DIST- 525 ACRES- 1.70
 GE010- PT SE4 SW4 SEC 12 22 62
 COMM- 066:305431 UPD- S-130-133-76 00/20/75
 ----- LAST UPD1- 00/24/00
 PARCEL- 210-120-000 INACTIVE- 029 DOCUMENT- 9999:9999999 02/02/60
 KERR MCGEE CHEMICAL CORP TAX DIST- 520 ACRES- 1.70
 GE010-
 COMM- 3.18 AC TO 21-11-07 UPD- S 094-096-74 09/12/73
 ----- LAST UPD1- 10/04/74
 PARCEL- 210-120-000 INACTIVE- 021 DOCUMENT- 9999:9999999 02/02/60
 AMERICAN POTASH & CHEMICAL CORP TAX DIST- 520 ACRES- 1.70
 GE010-
 COMM- 3.18 AC TO 21-11-07 UPD- S-152 172 73 10/19/72
 ----- LAST UPD1- 07/30/73

This record is for assessment purposes
 No liability is assumed to its accuracy

KMC DR
 04-0008882

PARCEL- 210-120-000 INACTIVE- 013 DOCUMENT- 9999:9999999 02/02/68
 KERR MCGEE CHEMICAL CORP TAX DIST- 620 ACRES- 1.70
 GE01D- UPD- S-021-022-73 01/21/72
 ----- LAST UPDI- 01/21/72
 PARCEL- 210-120-000 INACTIVE- 005 DOCUMENT- 0000:0000000
 AMERICAN POTASH & CHEMICAL CORP TAX DIST- 620 ACRES- 4.00
 GE01D- UPD- S-999-999-72 12/03/71
 ----- LAST UPDI- 12/03/71

This record is for assessment use only.
 No liability is assumed to its accuracy.

der@environcorp.com 29-Dec
 18:22

PCL 210-110-007 TAX DISTRICT- 525 ----- ASSESSOR DESCRIPTION -----
CHEMSTAR INC PT S2 S2 SEC 12 22 62

DOCUMENT- 061229:00376 12/29/06 1 NS
ACRES- 5.00
GE01D- PT S2 S2 SEC 12 22 62
UPDATE- A-000-147-09 04/14/07 LAST- 01/12/93
COMMENT- CERT OF AMND-070409:007

PARCEL- 210-110-007 INACTIVE- 021 DOCUMENT- 061229:00376 12/29/06 1 NS
GENSTAR LIME COMPANY TAX DIST- 525 ACRES- 5.00
GE01D- PT S2 S2 SEC 12 22 62
COMM- UPD- A-041-053-09 02/05/07
----- LAST UPD1- 04/02/07

PARCEL- 210-110-007 INACTIVE- 013 DOCUMENT- 0177:0141493 11/03/71 1 NS
FLINTKOTE CO TAX DIST- 525 ACRES- 5.00
GE01D- PT S2 S2 SEC 12 22 62
COMM- .39 AC FR 210-120-005 & 010 UPD- S-152-172-73 10/19/72
----- LAST UPD1- 09/14/04

PARCEL- 210-110-007 INACTIVE- 005 DOCUMENT- 0177:0141493 11/03/71
FLINTKOTE COMPANY TAX DIST- 520 ACRES- 5.00
GE01D-
COMM- .39 AC FR 210-120-005 & 010 UPD- S-021-022-73 01/27/72
----- LAST UPD1- 01/27/72

This record is for assessment use only
No liability is assumed to its accuracy.

This record is for assessment use only.
No liability is assumed to its accuracy.

RPTION -----
 PT 52 SEC 12 22 62
 ACRES - 33.17
 GEOTD- PT 52 SEC 12 22 62
 UPDATE- A-171-249-77 07/20/76 LAST- 10/16/92
 COMMENT- 066:385431
 PARCEL- 210-110-002 INACTIVE- 013 DOCUMENT- 9999:999999 02/02/60
 KERR MCGEE CHEMICAL CORP
 GEOTD-
 TAX DIST- 520 ACRES- 33.17
 COMMENT- 1.43AC TO 210-110-007
 UPD- S-021-022-73 01/27/72
 PARCEL- 210-110-002 INACTIVE- 005 DOCUMENT- 0000:000000
 AMERICAN POLISH & CHEMICAL CORP
 TAX DIST- 520 ACRES- 34.60
 GEOTD-
 UPD- S-999-999-72 12/03/71
 COMMENT- INITIAL
 LAST UPD- 12/03/71

T

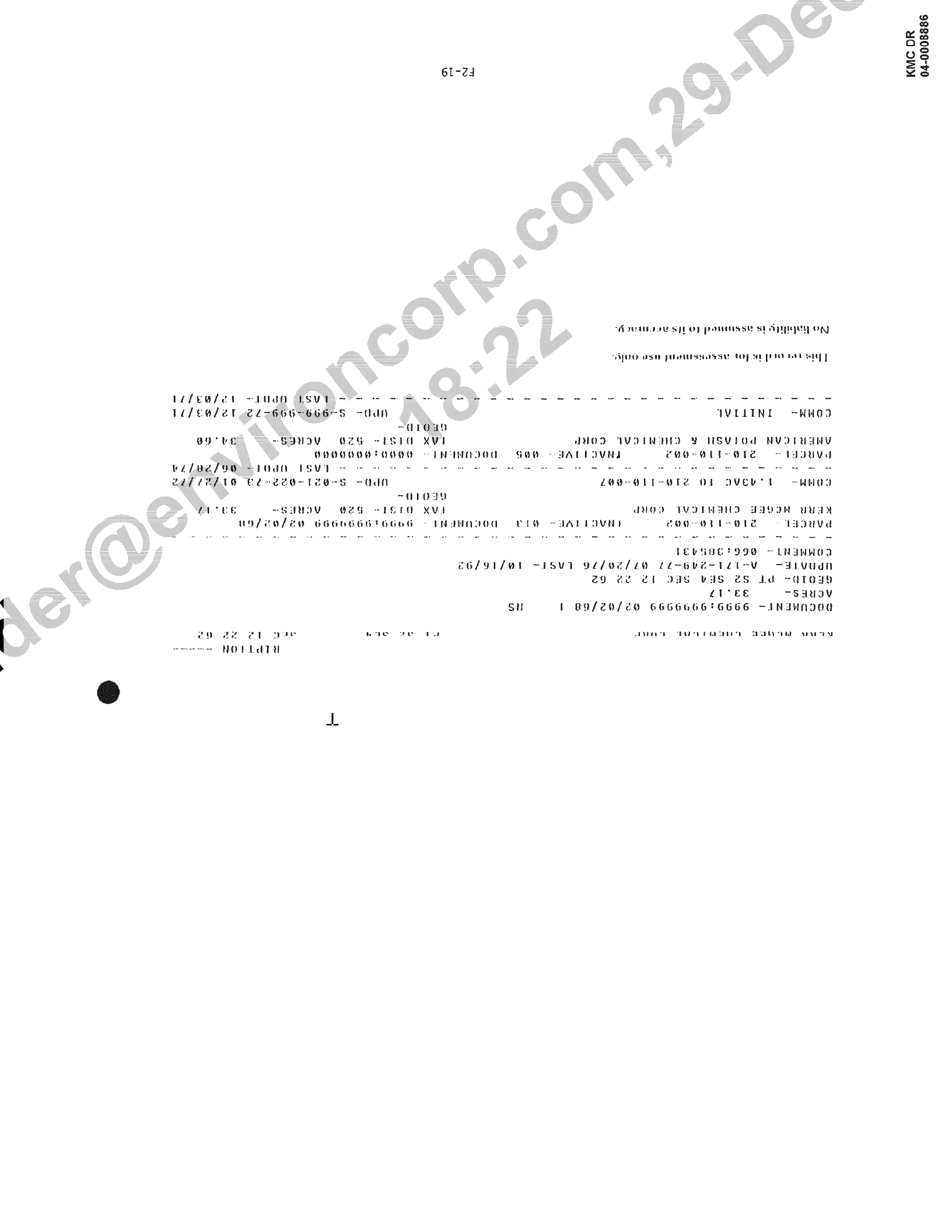

der@environcorp.com, 29-Dec
18:22

This record is for assessment use only.
No liability is assumed to its accuracy.

PCL 210-460-001 TAX DISTRICT- 526
 AMERICAN POTASH & CHEMICAL CORP
 PL 52 ME4
 ASSESSOR DESCRIPTION
 DOCUMENT- 00661005431 99/99/99 T NS
 ACRES- 19.70
 GEOID- PT S2 N2 SEC 13 22 62
 UPDATE- S-999-999-72 12/03/11 EAST- 10/23/92
 COMMENT- 067:089974

T

PCL 210-420-002 TAX DISTRICT- 525 ----- ASSESSOR DESCRIPTION -----
AMERICAN POTASH & CHEMICAL CORP PT N2 NE4 SEC 13 22 62

DOCUMENT- 0066:0306431 99/99/99 1 HS
ACRES- 14.20
GEOTID- PT N2 NE4 SEC 13 22 62
UPDATE- S-999-999-72 12/03/71 LAST- 10/23/92
COMMENT- 067:309974

This record is for assessment use only.

No liability is assumed to its accuracy.

der@environcorp.com 29-Dec
18:22

PCL 210-420-004 TAX DISTRICT- 525 ----- ASSESSOR DESCRIPTION -----
AMERICAN POTASH & CHEMICAL CORP PT N2 NE4 SEC 13 22 62

DOCUMENT- 0066:0305431 99/99/99 1 NS
ACRES- 11.06
GEOID- PT N2 NE4 SEC 13 22 62
UPDATE- S-999-999-72 12/03/71 LAST- 10/23/92
COMMENT- 067:309974

This record is for assessment use only.

No liability is assumed to its accuracy.

der@environcorp.com, 29-Dec
18:22

KMC DR
04-0008839

T

 PCL 210-460-004 TAX DISTRICT-- 525 ----- ASSESSOR DESCRIPTION
 AMERICAN POTASH & CHEMICAL CORP
 PT N2 SEC 13 22 62
 ACRES-- 20.70
 GEOID-- PT N2 SEC 13 22 62
 UPDATE-- S-123-126-76 08/08/75 EAST-- 10/23/92
 COMMENT-- 067:309974
 PARCEL-- 210-460-004 INACTIVE-- 013 DOCUMENT-- 0066:0385431 99/99/99
 AMERICAN POTASH & CHEMICAL CORP
 TAX DIST-- 520 ACRES-- 20.70
 GEOID--
 UPD-- S-152-172-73 10/19/72
 COMMENT-- 067:309974
 PARCEL-- 210-460-004 INACTIVE-- 005 DOCUMENT-- 0000:00000000
 AMERICAN POTASH & CHEM CORP
 TAX DIST-- 520 ACRES-- 20.70
 GEOID--
 UPD-- S-999-999-72 12/03/71
 COMMENT-- 067:309974
 COMM-- INITIAL

 LAST UPD-- 12/03/71

This record is for assessment use only.
 No liability is assumed to its accuracy.

T

der@envirocorp.com, 29-Dec-22 18:22

der@environcorp.com, 29-Dec
18:22

PCL 210-410-002 TAX DISTRICT-- 525
 AMERICAN POLISH & CHEMICAL CORP
 ----- ASSESSOR DESCRIPTION -----
 PL N2 NMA SEC 13 22 62
 DOCUMENT-- 0066:0305431 99/99/99 1 NS
 ACRES-- 21.36
 GE010- PT NE4 N04 SEC 13 22 62
 UPDATE-- S-999-999-72 12/03/71 LAST-- 10/23/92
 COMMENT-- 067:389974

This records for assessment use only.
 No liability is assumed to its accuracy.

T